

# **SURGICAL**

Instruments Catalogue



*Trocar  
Biopsy Needles  
Elevators  
Periosteal  
Bone Files  
Curettes*



**Health Fast Surgical**  
Surgical Manufacturer Company

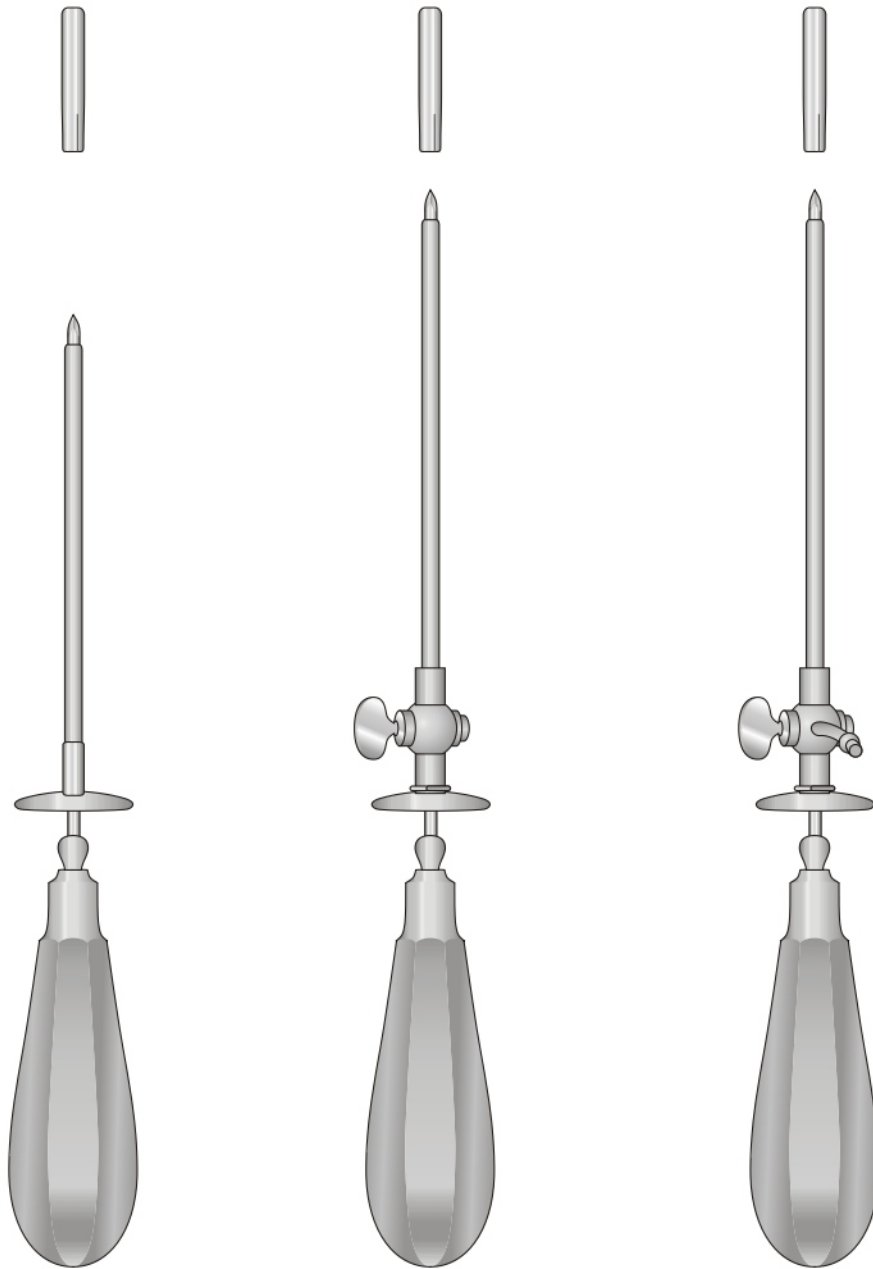

Ø mm Esterno Outside Außen Extérieur Exterior	Ø mm Interno Inside Innen Intérieur Interior	HS-11501 STANDARD	HS-11502 STANDARD	HS-11503 STANDARD
3,0	2,0	HS-11501-1	HS-11502-1	HS-11503-1
3,5	2,5	HS-11501-2	HS-11502-2	HS-11503-2
4,0	3,0	HS-11501-3	HS-11502-3	HS-11503-3
4,5	3,5	HS-11501-4	HS-11502-4	HS-11503-4
5,0	4,0	HS-11501-5	HS-11502-5	HS-11503-5
5,5	4,5	HS-11501-6	HS-11502-6	HS-11503-6
6,0	5,0	HS-11501-7	HS-11502-7	HS-11503-7
		110 mm	120 mm	120 mm

Per vescica biliare - For gall bladder - Für die gallenblase  
Pour la vésicule biliaire - Para vesícula biliar

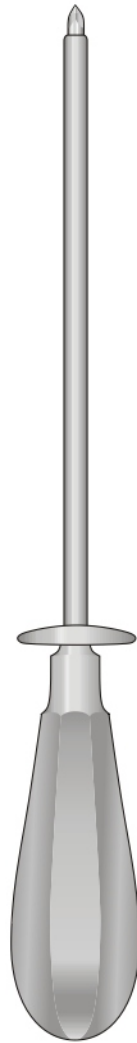
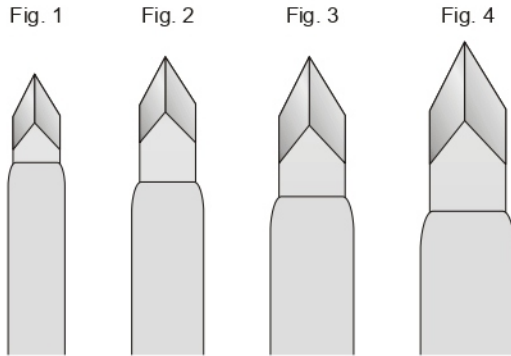

Ø mm Esterno Outside Außen Extérieur Exterior	Ø mm Interno Inside Innen Intérieur Interior		
7,5	6,0	Fig. 1	NELSON 10-130-01
9,5	8,0	Fig. 2	10-130-02
11,0	9,5	Fig. 3	10-130-03
12,5	11,0	Fig. 4	10-130-04
210 mm			

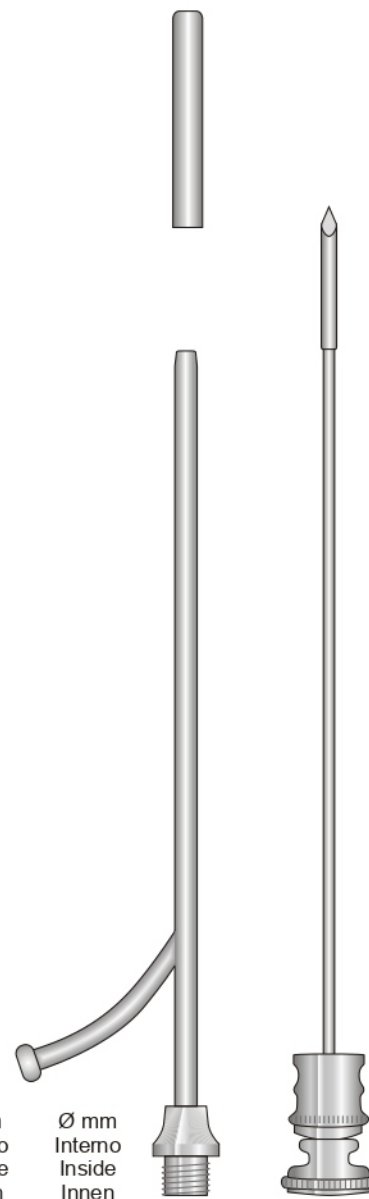

Ø mm Esterno Outside Außen Extérieur Exterior	Ø mm Interno Inside Innen Intérieur Interior	
4,0	3,0	OCHSNER HS-11505-1
4,6	3,6	HS-11505-2
5,3	4,3	HS-11505-3
6,0	5,0	HS-11505-4
210 mm		



Trequarti per seno mascellare  
Antrum puncture trocars  
Kieferhöhlentrokare  
Trocarts pour sinus maxillaire  
Trócares para punción del seno maxilar

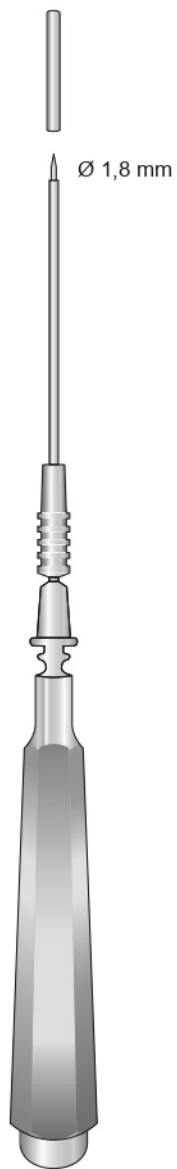

LICHTWITZ  
HS-11506  
190 mm

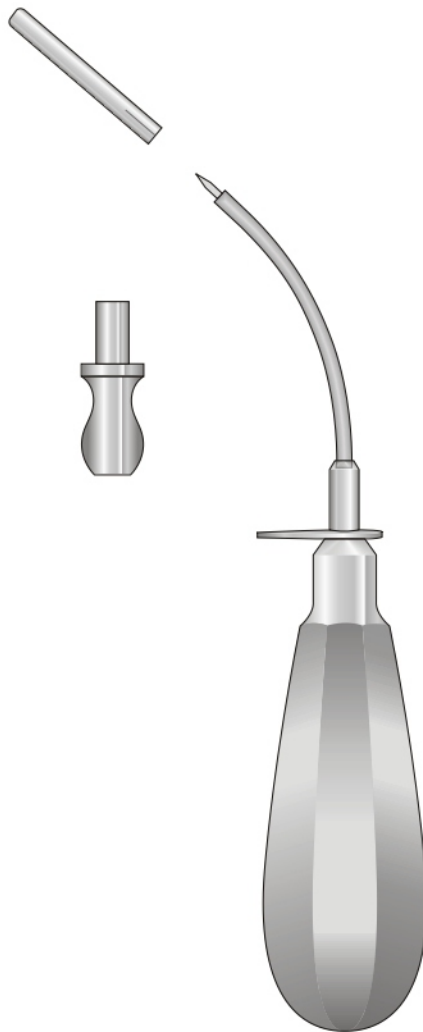

PIERCE  
HS-11506-1 Ø 3 mm  
HS-11506-2 Ø 4 mm  
HS-11506-3 Ø 5 mm  
160 mm

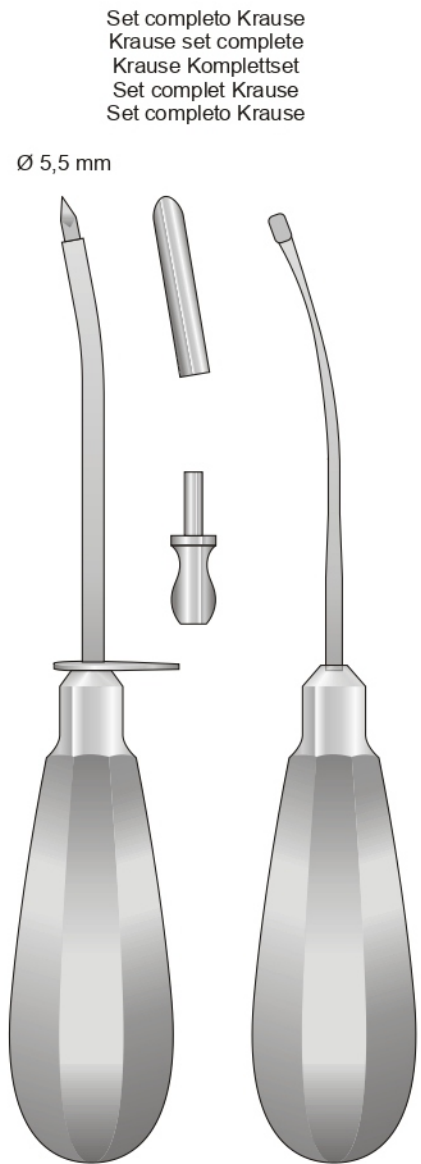

KRAUSE  
HS-11507  
160 mm

Set completo Krause  
Krause set complete  
Krause Komplettsset  
Set complet Krause  
Set completo Krause

Ø 1,8 mm

Ø 5,5 mm

Universale completo con 3 punte  
Set of 3 pieces  
Satz zu 3 stück  
Jeu de 3 pièces  
Juego de 3 piezas

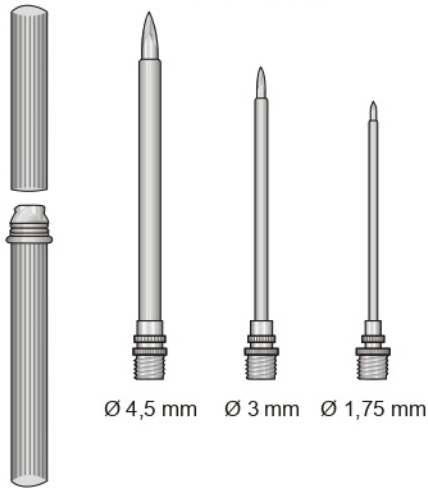

UNIVERSAL  
HS-11509-1

Universale completo con 4 punte  
Set of 4 pieces  
Satz zu 4 stück  
Jeu de 4 pièces  
Juego de 4 piezas

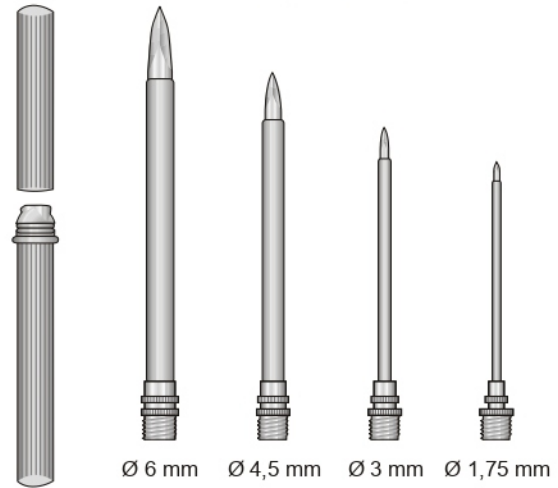

UNIVERSAL  
HS-11509-2

Universale completo con 3 punte  
Set of 3 pieces  
Satz zu 3 stück  
Jeu de 3 pièces  
Juego de 3 piezas

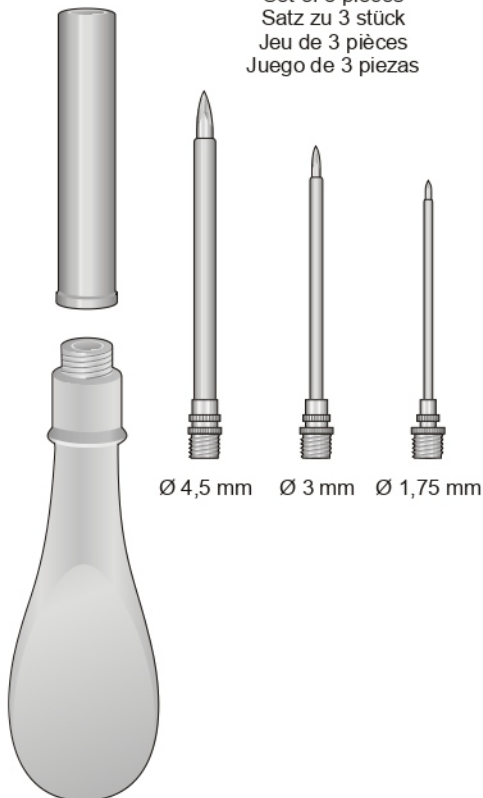

HS-11510-1  
130 mm

Universale completo con 4 punte  
Set of 4 pieces  
Satz zu 4 stück  
Jeu de 4 pièces  
Juego de 4 piezas

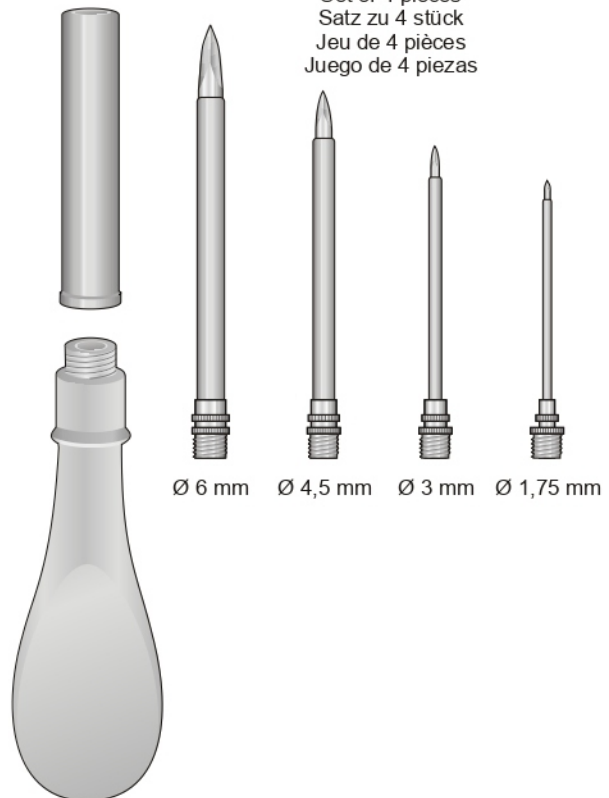

HS-11510-2  
130 mm

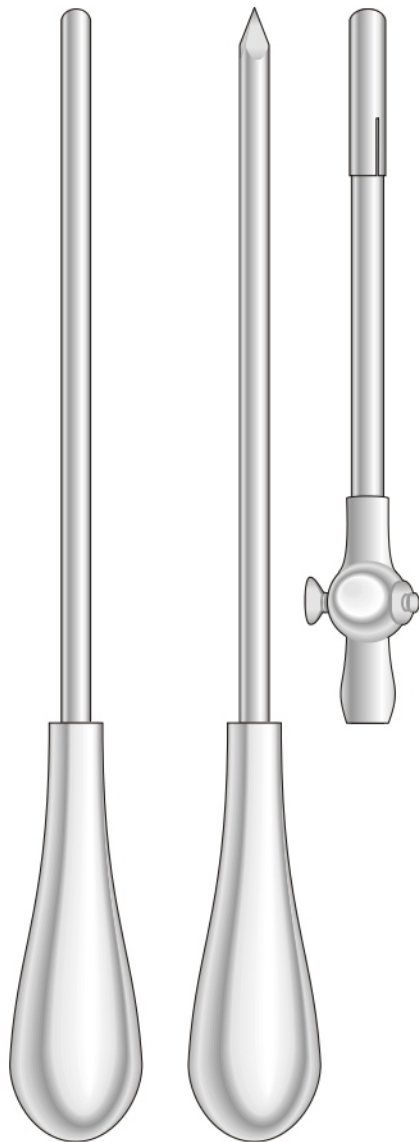

Ø mm	Ø mm
Esterno	Interno
Outside	Inside
Außen	Innen
Extérieur	Intérieur
Exterior	Interior

		BUELAU
8	6,5	HS-11511-1
10	8,5	HS-11511-2

240 mm

Ago per la puntura dello sterno  
Sternal puncture needle  
Sternal-punktionskänülen  
Aiguilles pour la ponction sternale  
Agujas para punción esternal

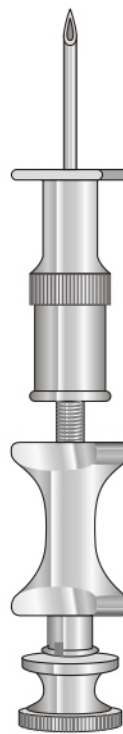

KLIMA-ROSEGGER  
HS-11512  
1,80 x 35 mm

DUKE  
110 mm - 5,5 mm

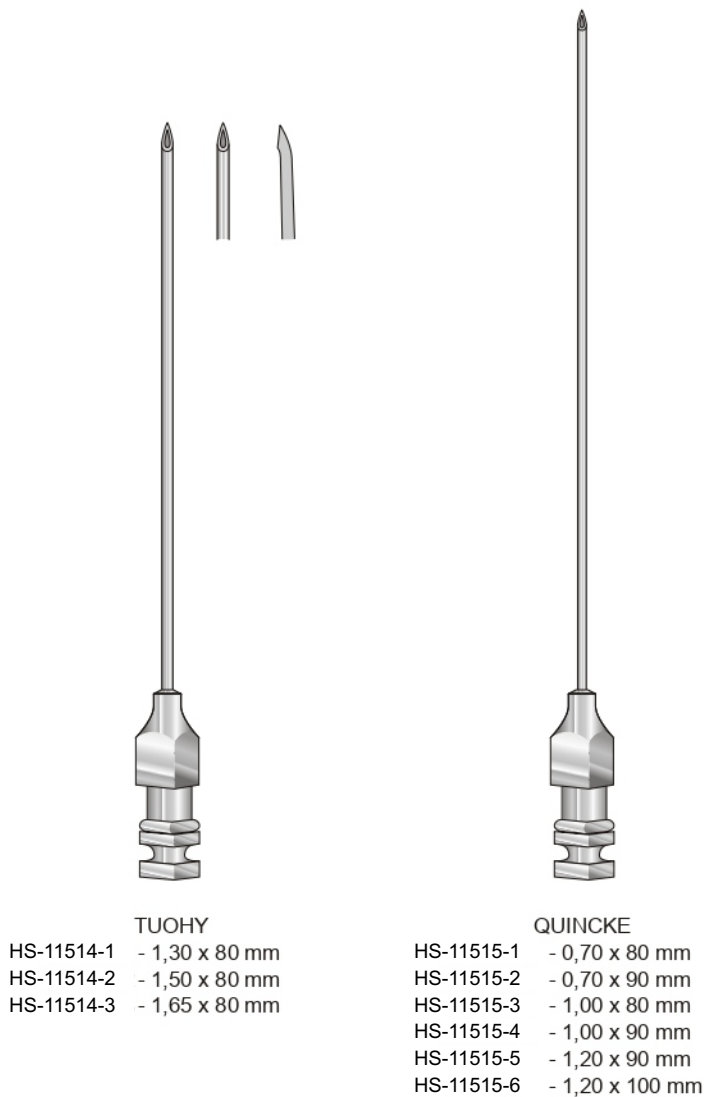
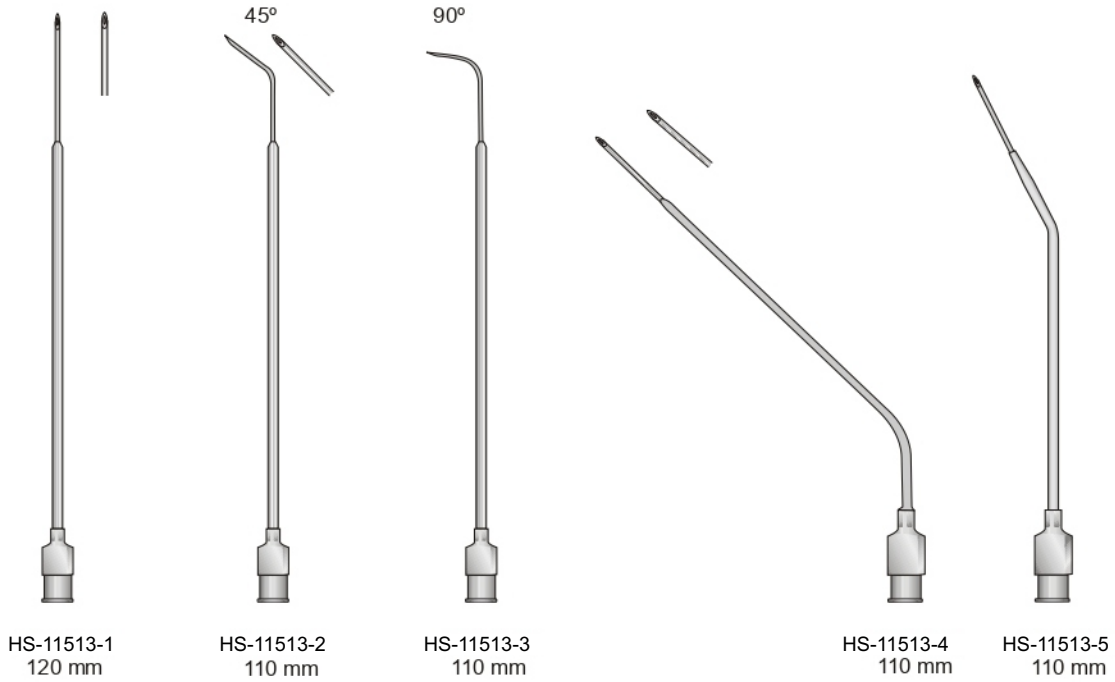

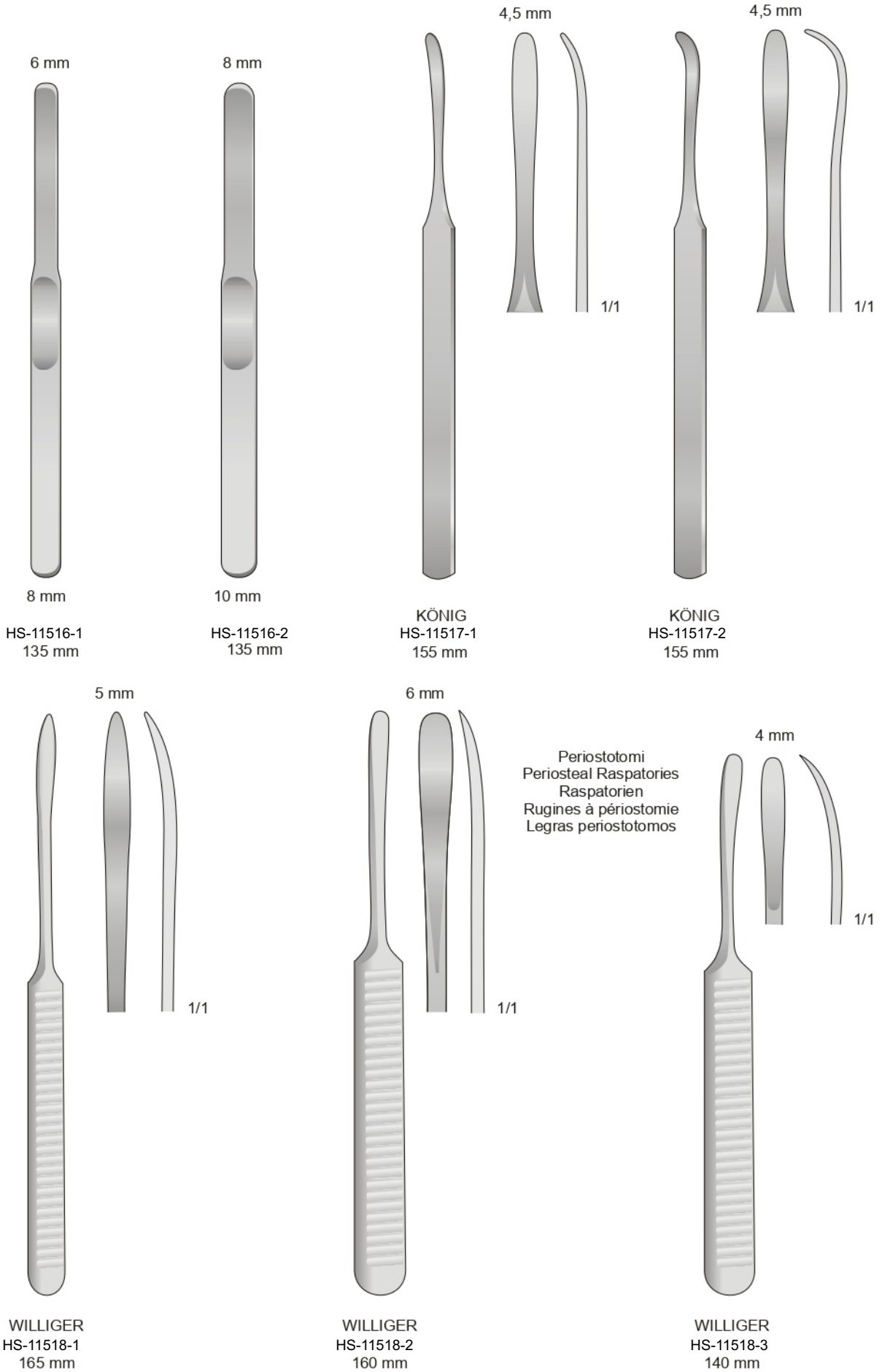



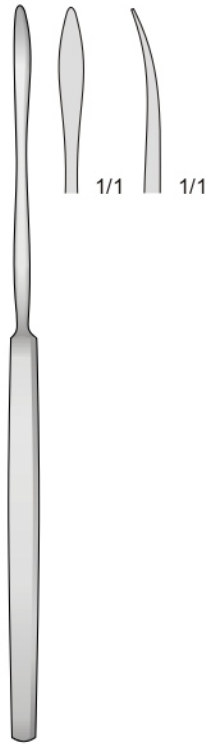

HS-11519-1  
175 mm

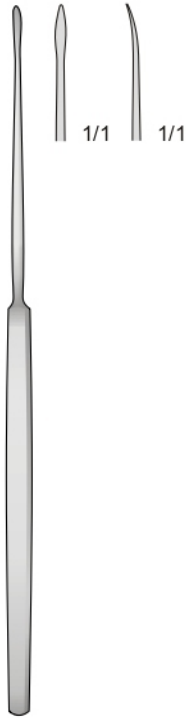

HS-11519-2  
160 mm

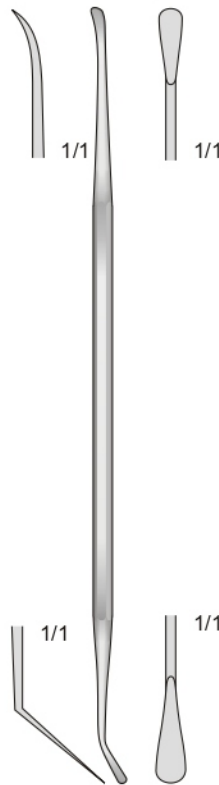

MILLIGAN  
 HS-11520  
 210 mm

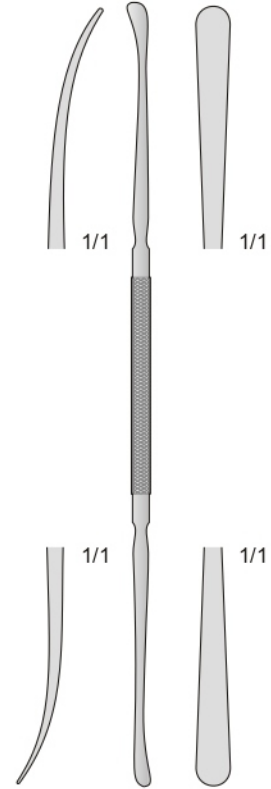

DAVIS  
 HS-11521  
 245 mm

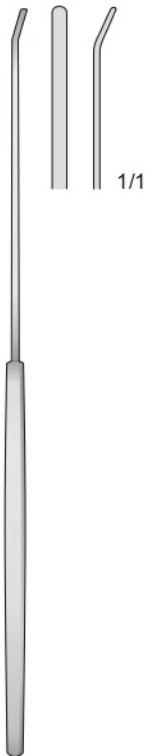

FAGER  
 HS-11522-1  
 200 mm

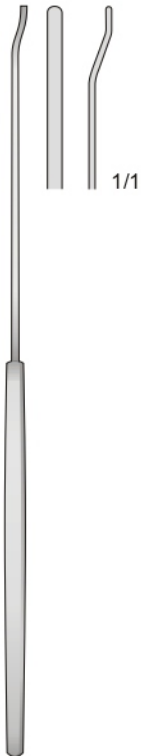

FAGER  
 HS-11522-2  
 200 mm

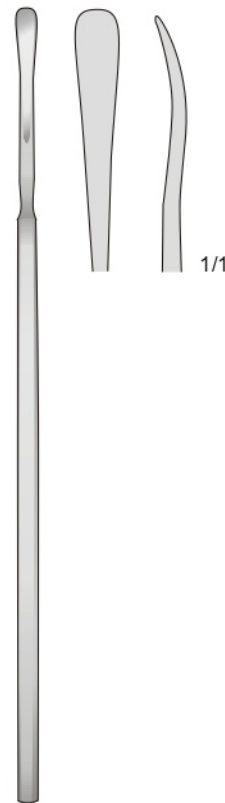

SACHS  
 HS-11523-1  
 210 mm

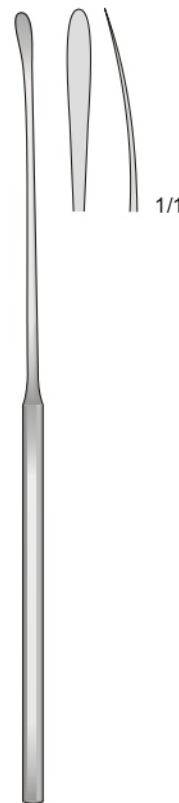

SACHS  
 HS-11523-2  
 210 mm

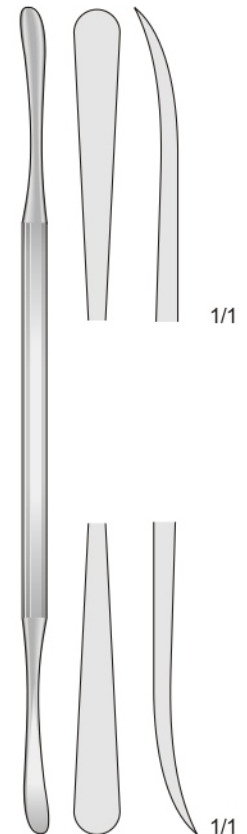

HS-11524  
 220 mm

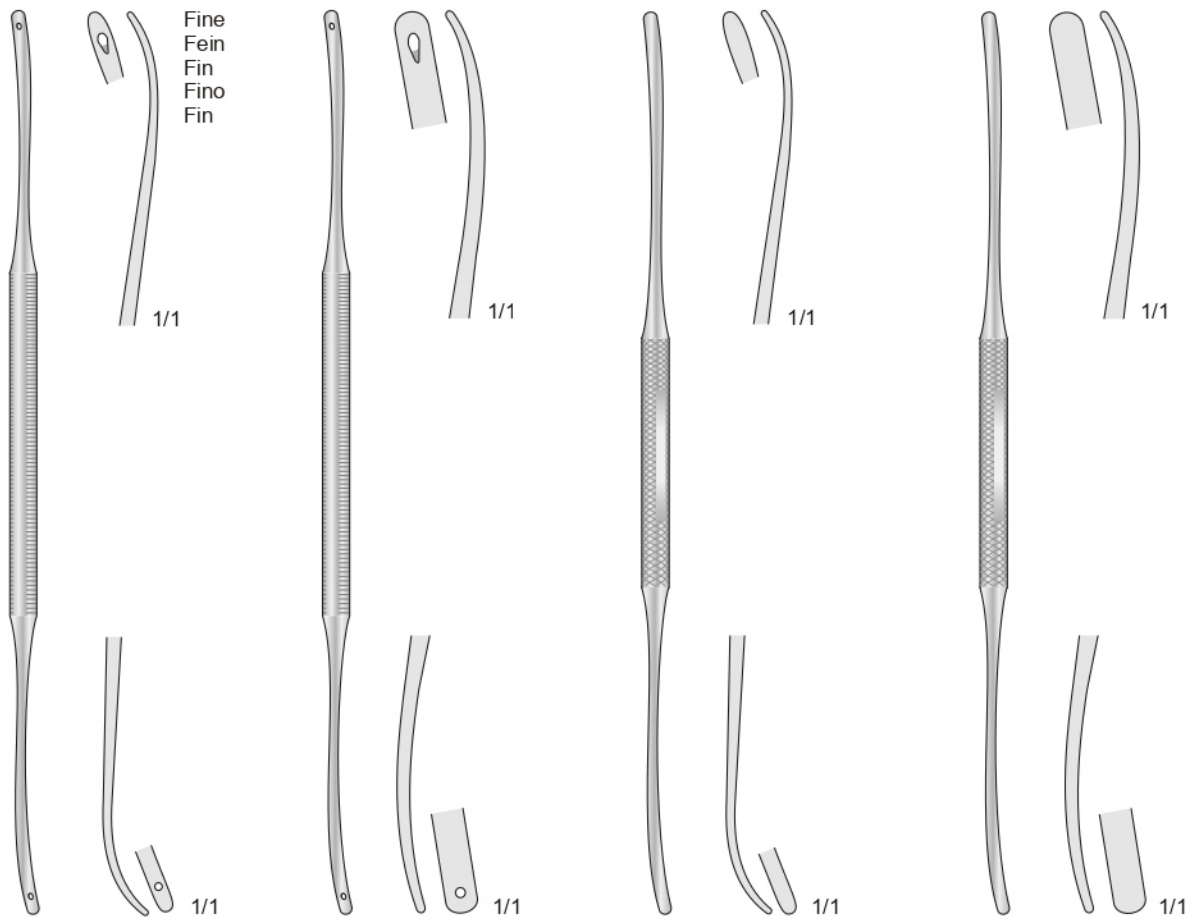

Fine  
Fein  
Fino  
Fin

HS-11524-1 - 180 mm  
HS-11524-2 - 240 mm

HS-11524-3 - 180 mm  
HS-11524-4 - 240 mm

OLIVECRONA  
HS-11525-1 - 180mm  
HS-11525-2 - 240mm

OLIVECRONA  
HS-11525-3 - 195mm  
HS-11525-4 - 240mm

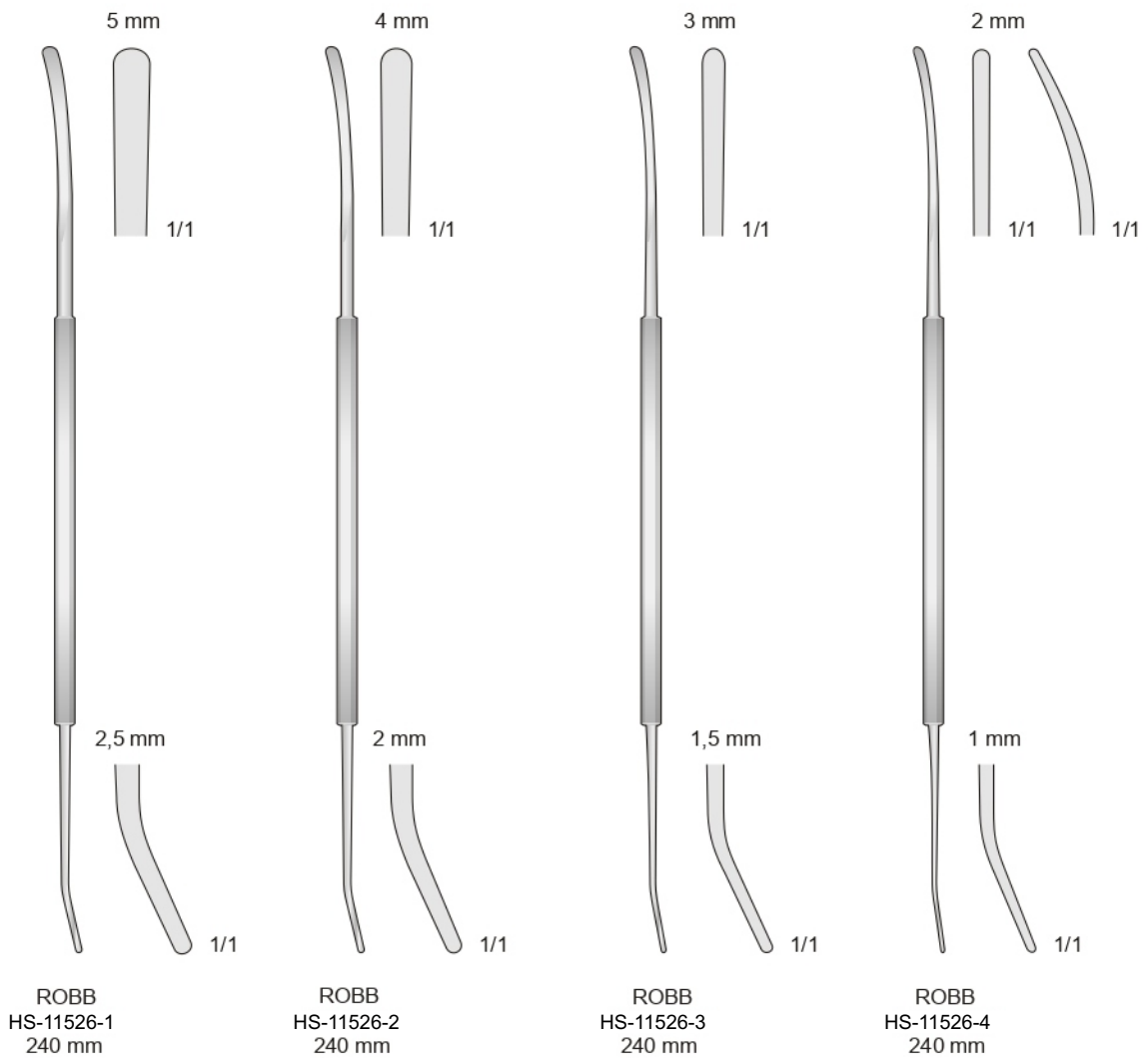



Nerve protectors

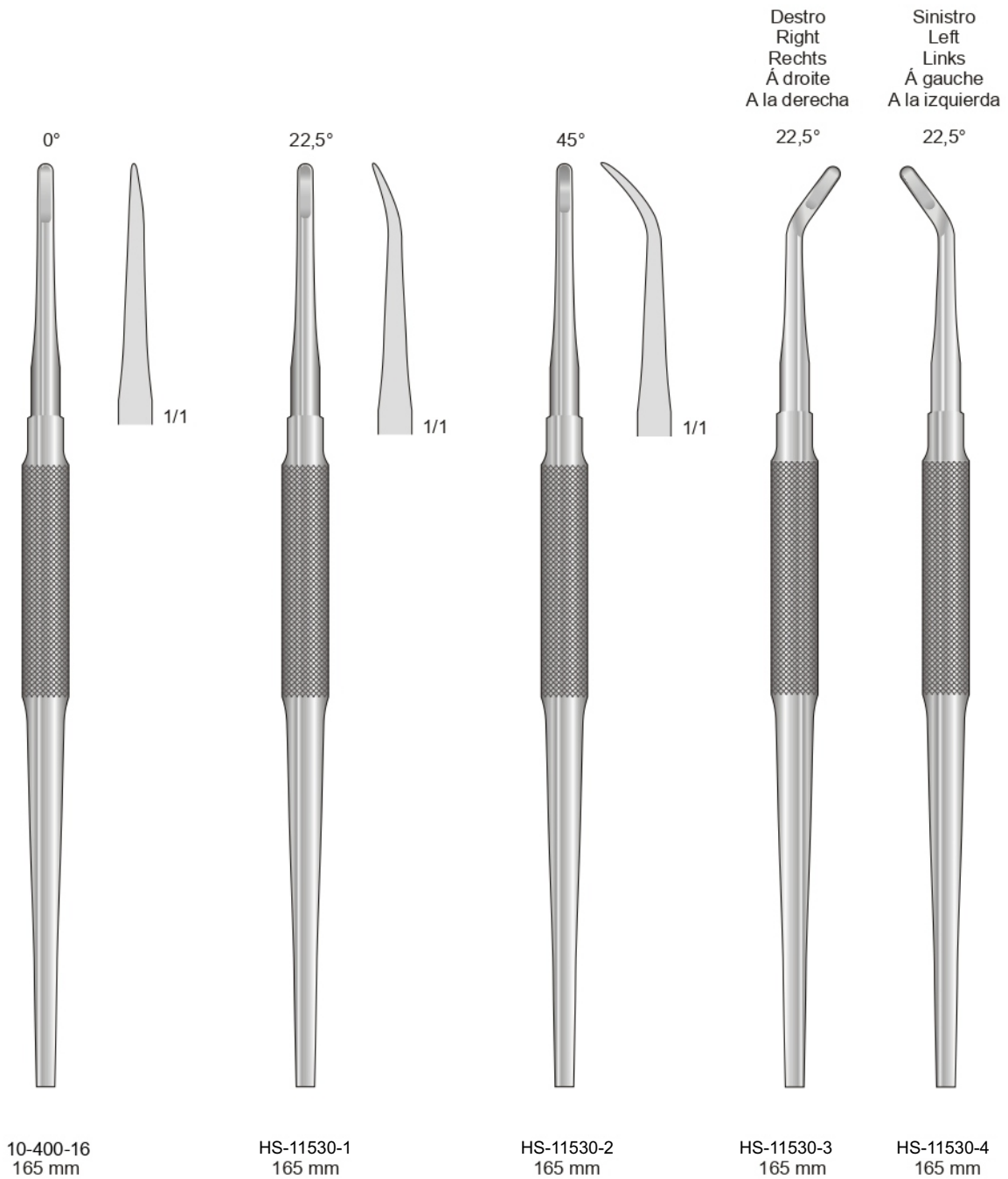

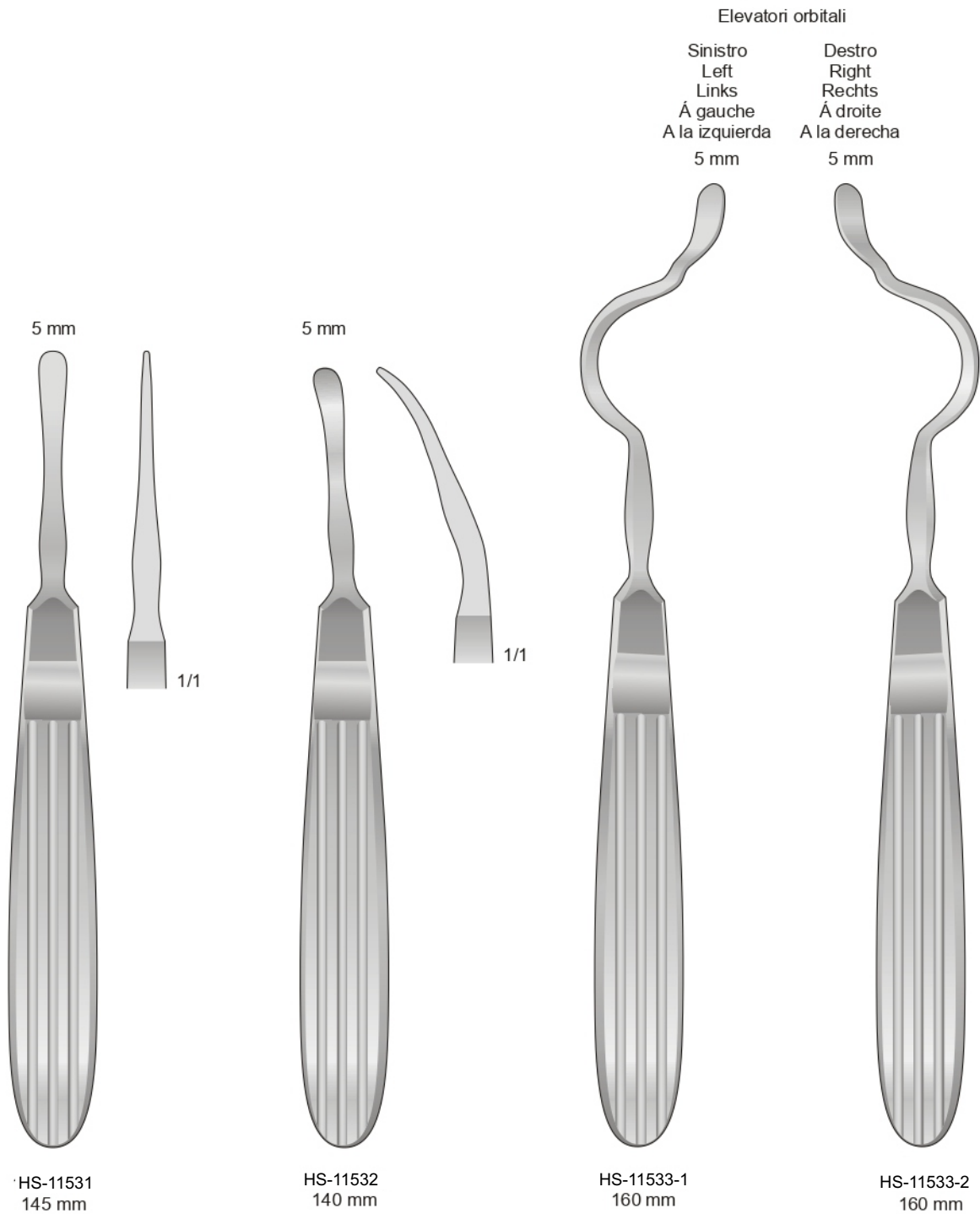

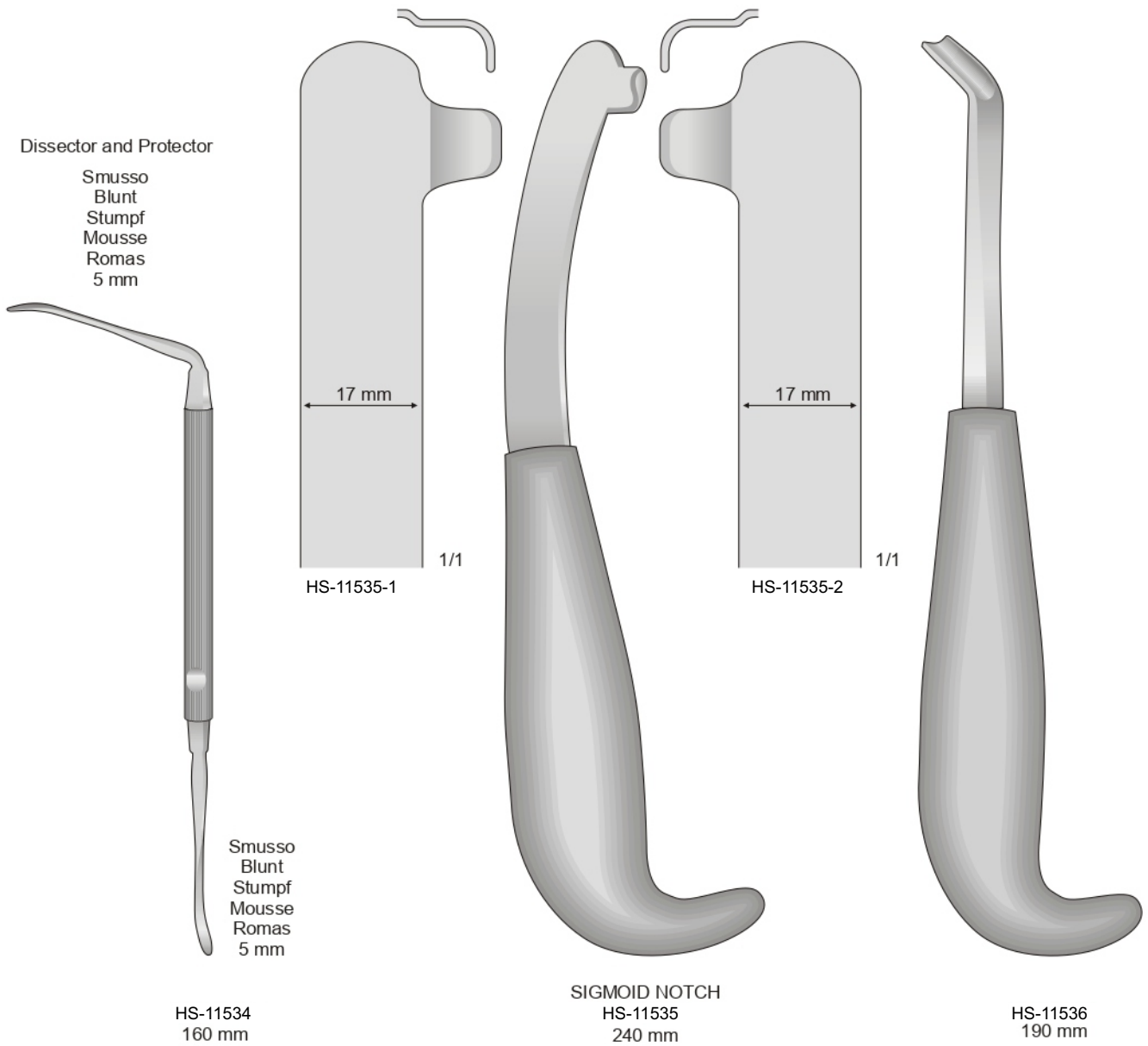

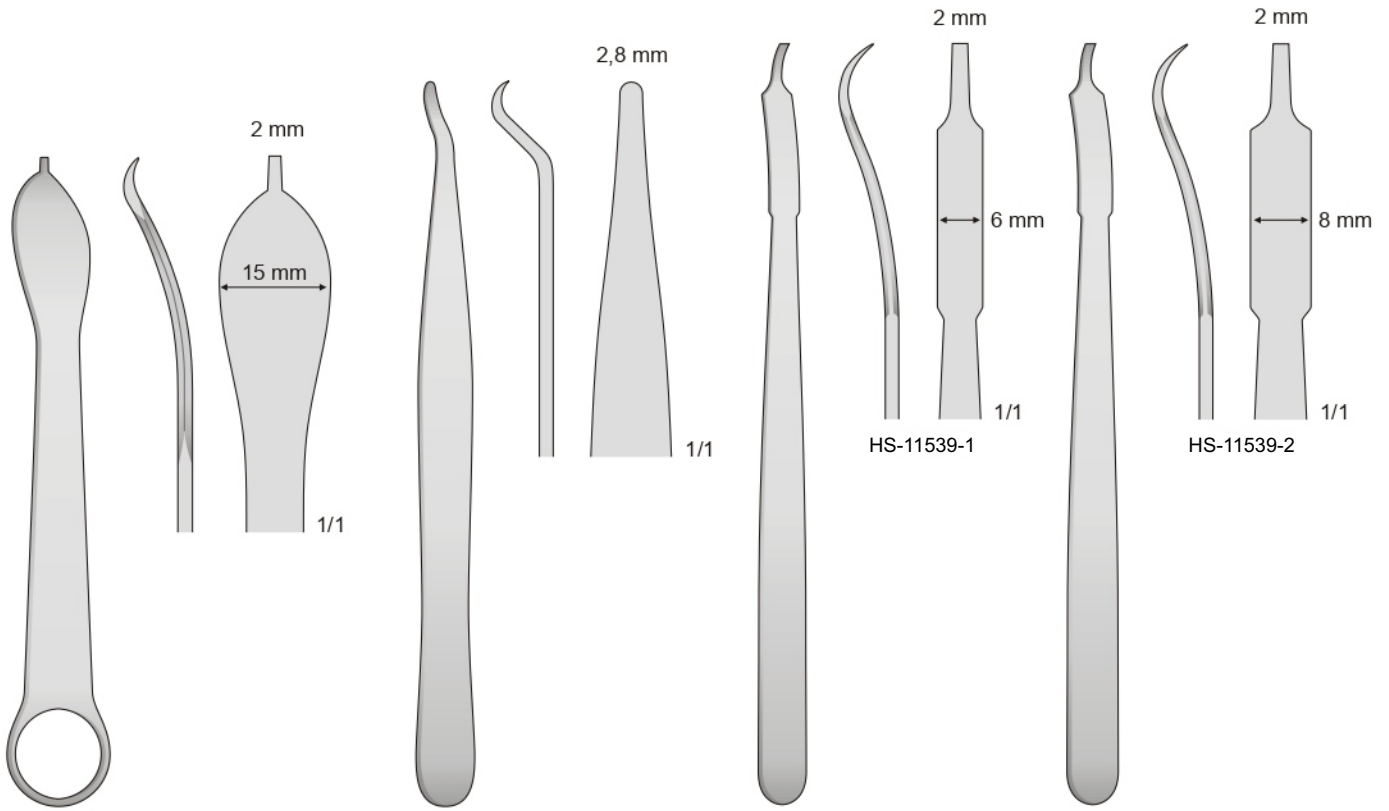

HS-11537  
120 mm

HS-11538  
140 mm

MINI-HOHMANN  
HS-11539-1  
160 mm

MINI-HOHMANN  
HS-11539-2  
160 mm

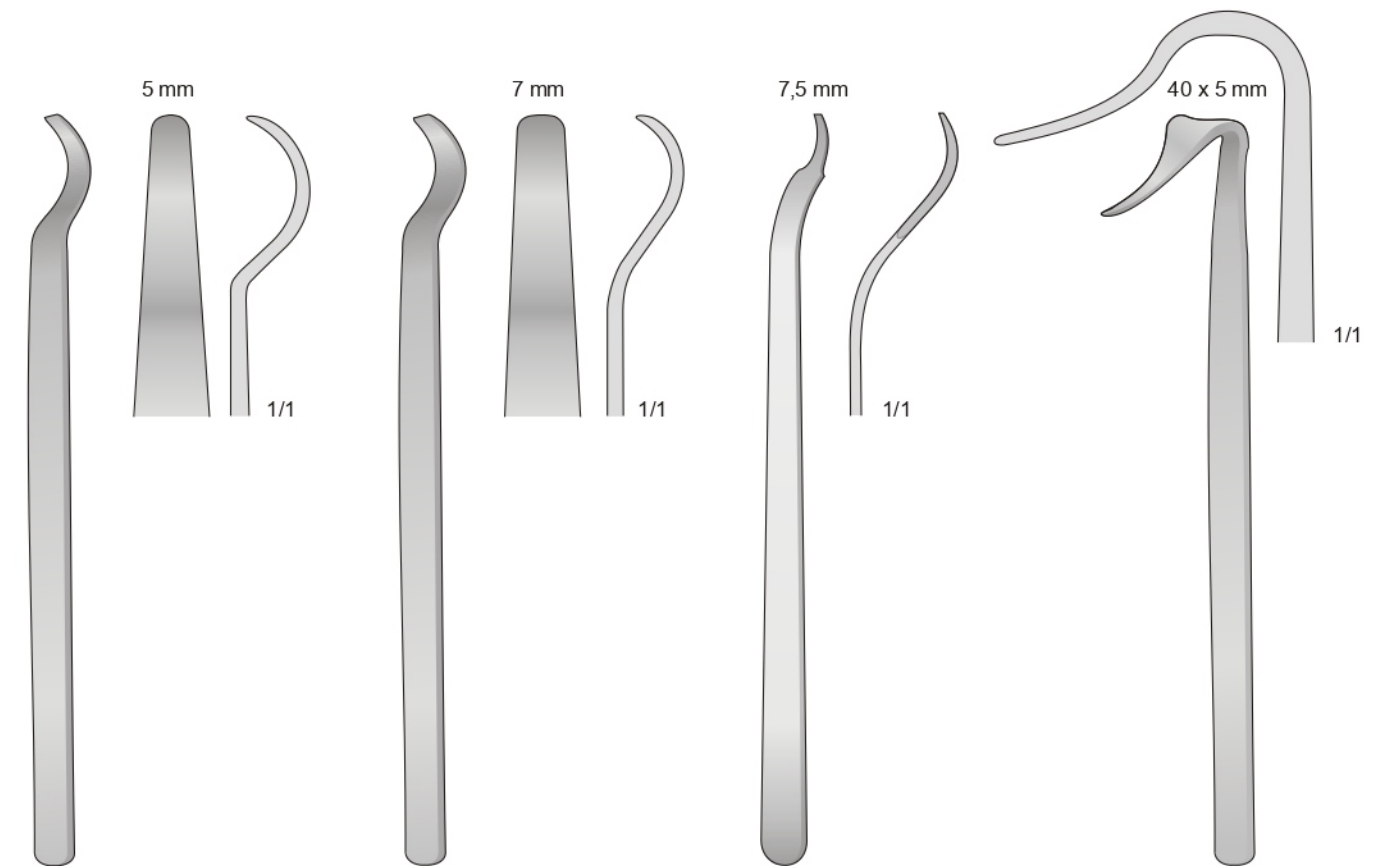

HS-11540  
150 mm

HS-11541  
150 mm

BUCK-GRAMCKO  
HS-11542  
150 mm

BLOUNT  
HS-11543  
175 mm



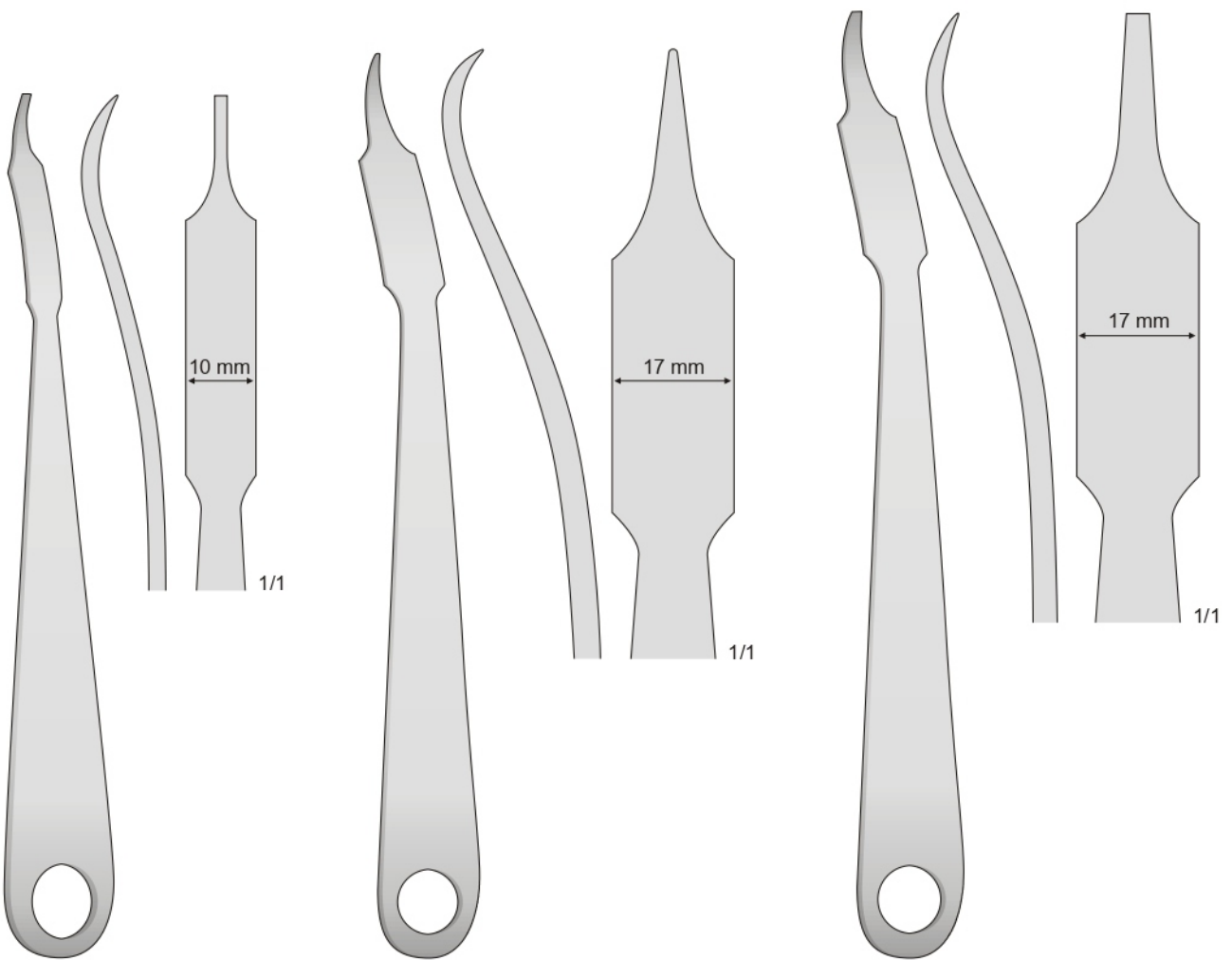

HS-11544-1  
220 mm

HS-11544-2  
240 mm

HS-11544-3  
240 mm

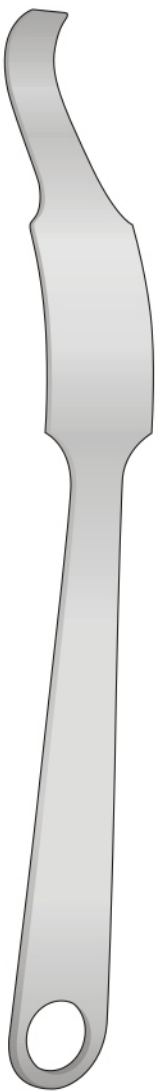

HOHMANN  
HS-11545

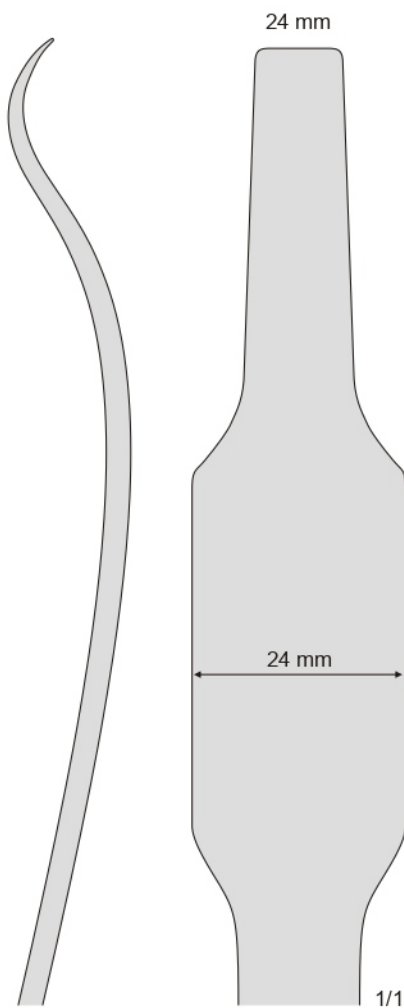

HS-11545-1  
260 mm

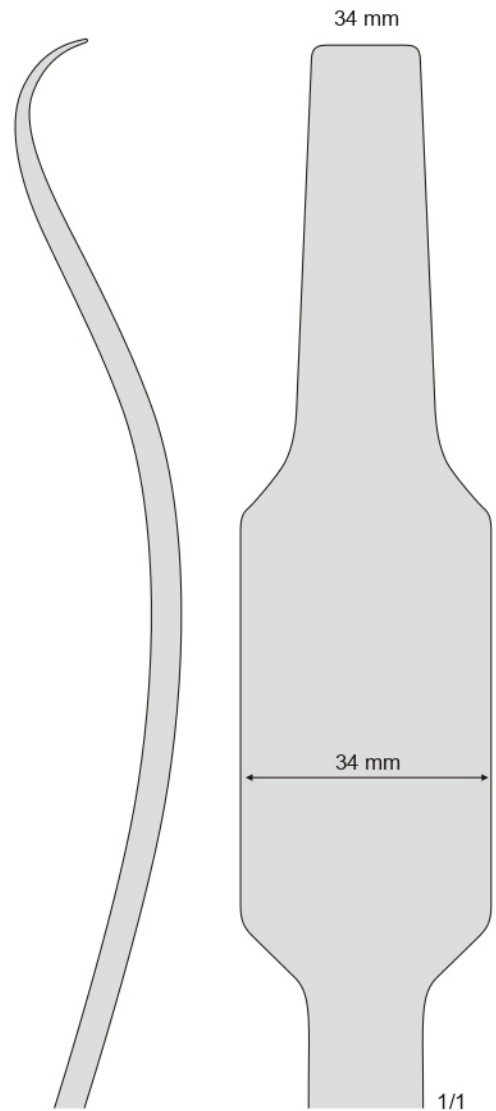

HS-11545-2  
285 mm

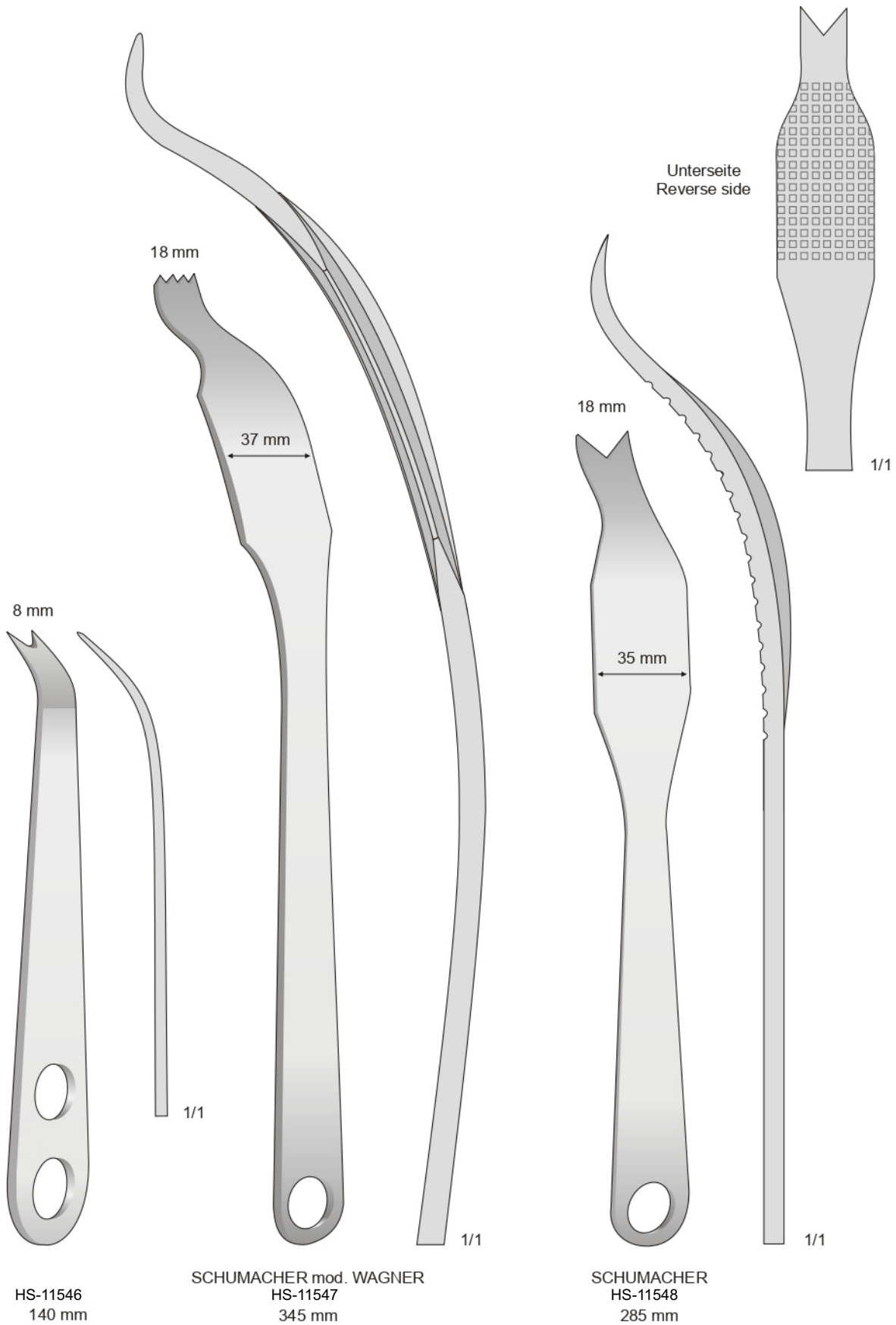

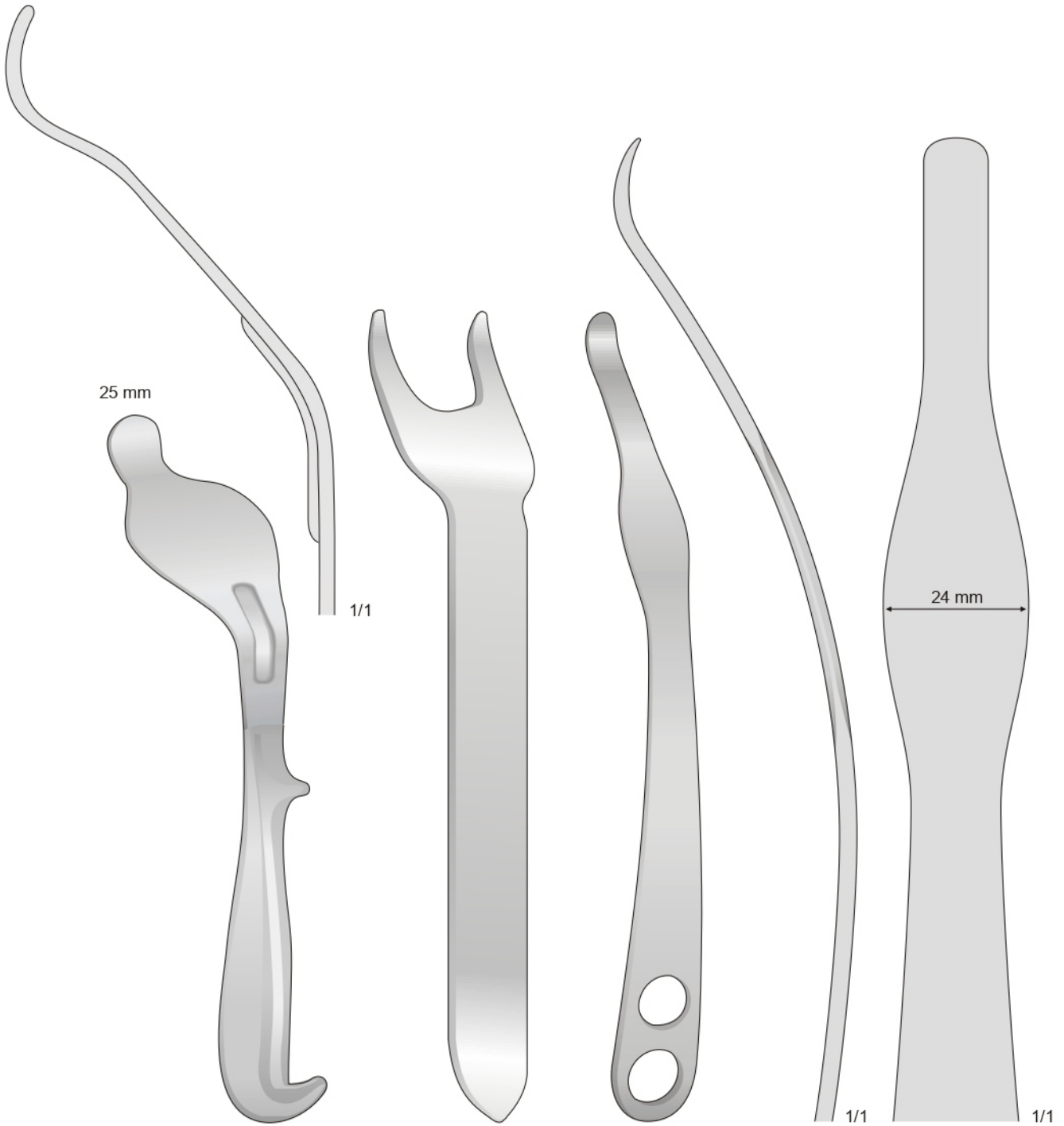

**BENNETT**  
HS-11549-1 43 mm  
HS-11549-2 60 mm  
240 mm

**BLOUNT**  
HS-11550  
260 mm

**HS-11551**  
260 mm

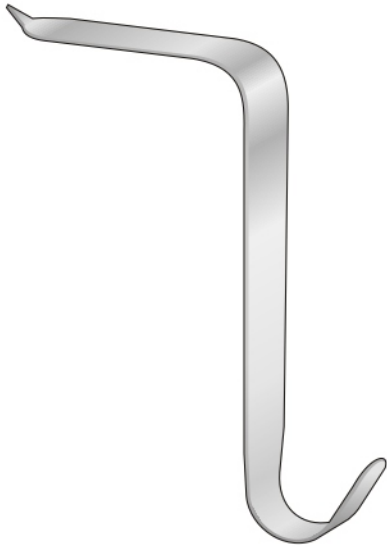

TAYLOR  
 10-610-01 75 x 30 mm  
 HS-11552-2 100 x 30 mm  
 165 mm

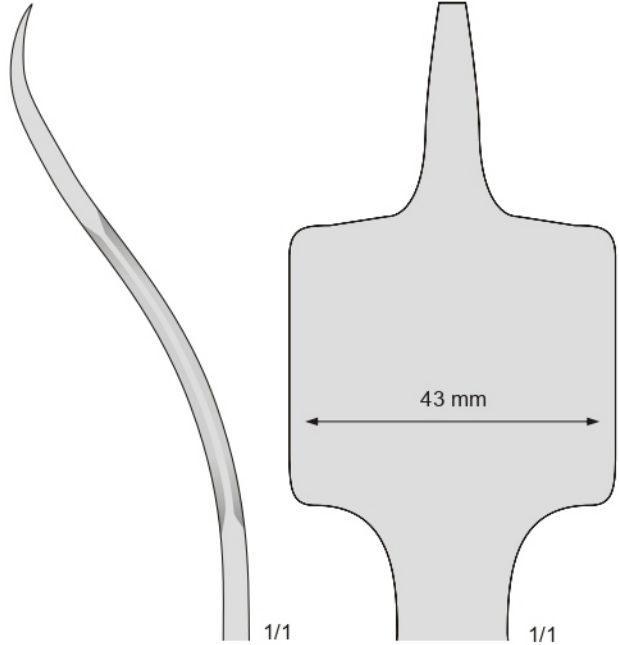

HS-11554-1  
 240 mm

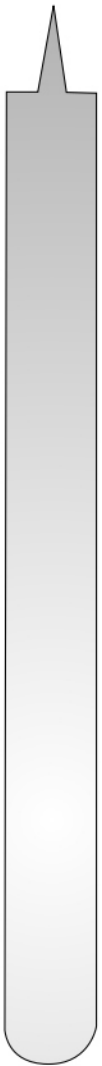

HS-11553  
 250 mm

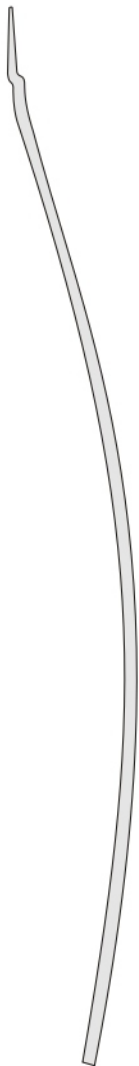

HOHMANN  
 HS-11554  
 240 mm

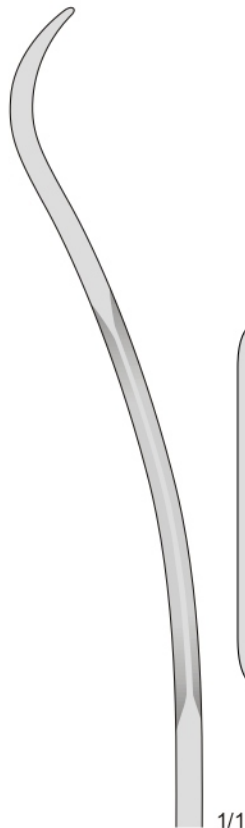
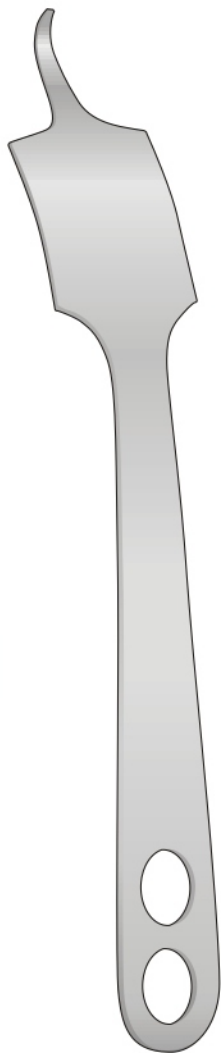

HS-11554-2  
 240 mm

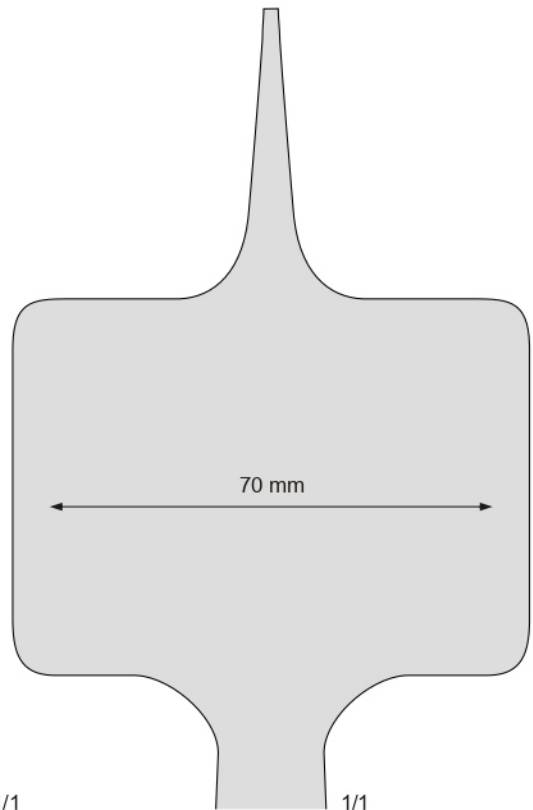

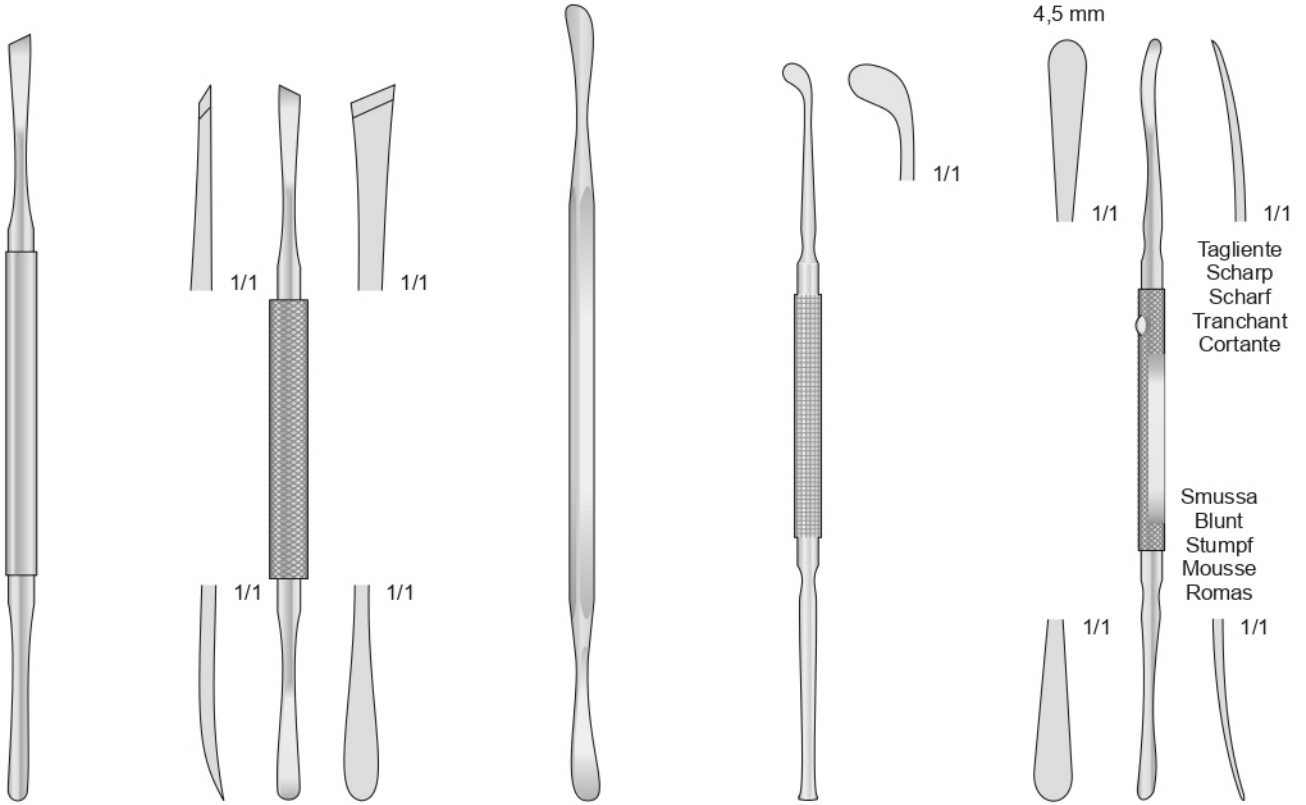

HS-11555  
185 mm

10-650-16  
165 mm

ALDERDYCE  
HS-11557  
210 mm

FREER  
HS-11558  
190 mm

HS-11559  
180 mm

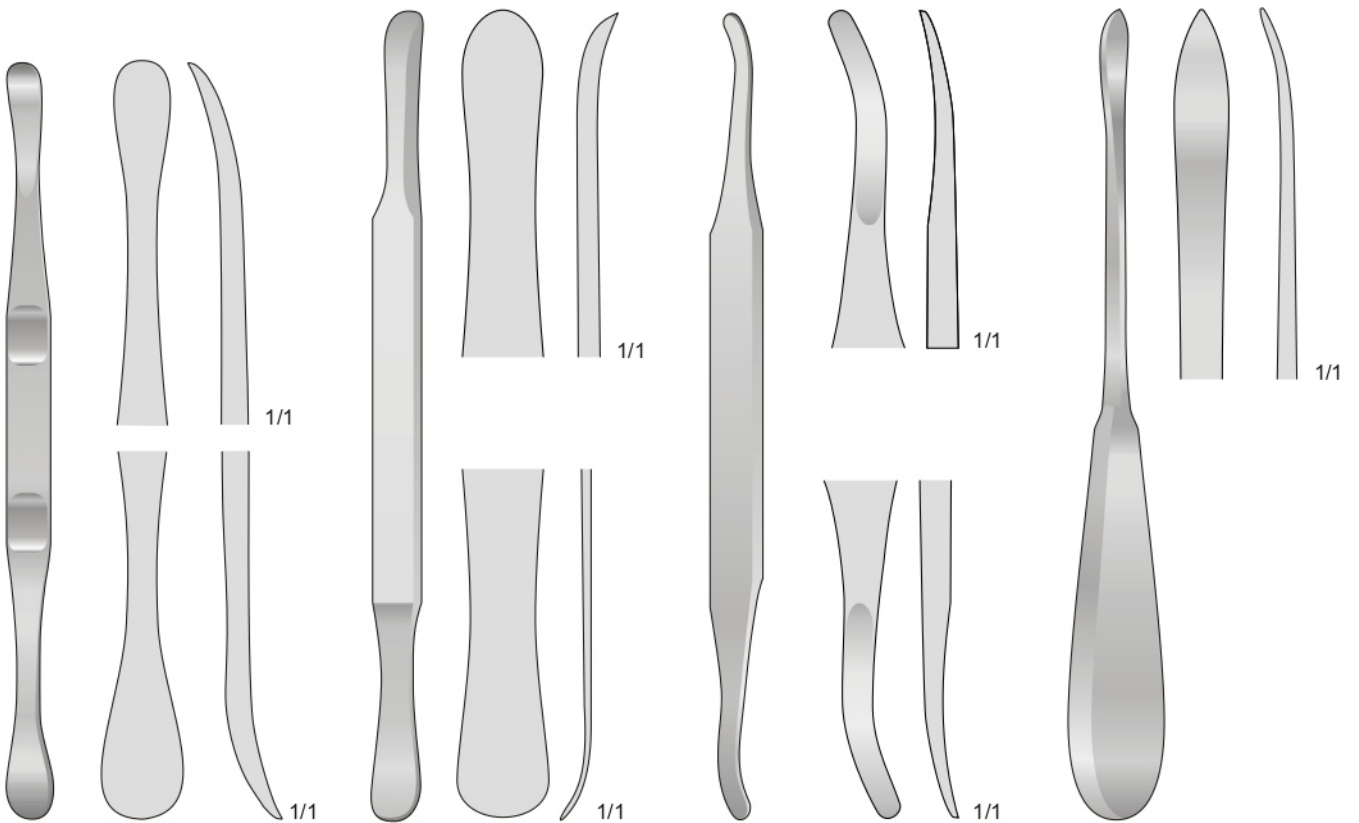

BABBUSH  
HS-11560  
180 mm

SELDIN  
HS-11561  
195 mm

SELDIN  
HS-11562  
190 mm

LANGENBECK  
HS-11563  
200 mm

4 mm

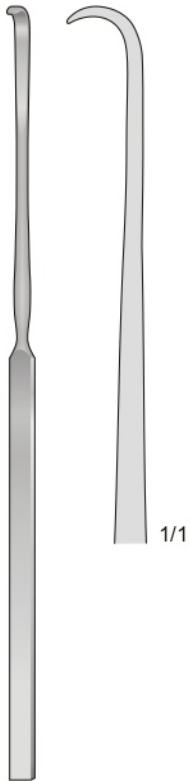

HS-11564  
200 mm

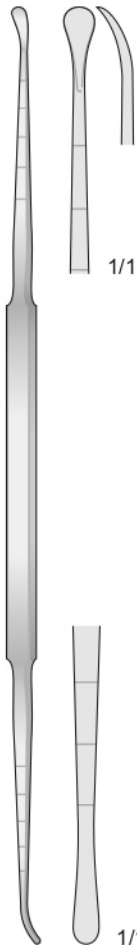

COTTLE  
HS-11565  
220 mm



MASING  
HS-11566  
210 mm

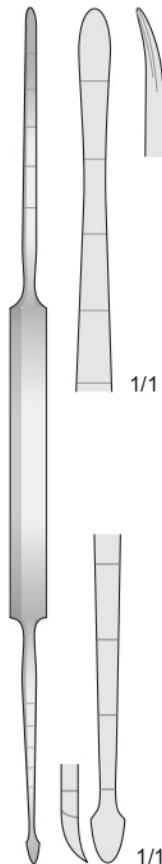

COTTLE  
HS-11567  
210 mm



SALZBURG  
HS-11568  
245 mm

Tagliente  
Sharp  
Scharf  
Tranchant  
Cortante

5 mm

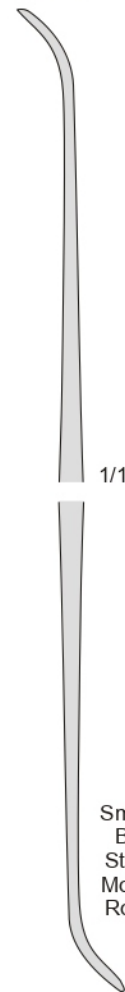

Smussa  
Blunt  
Stumpf  
Mousse  
Romas

1/1



SALZBURG  
HS-11569  
245 mm

Tagliente  
Sharp  
Scharf  
Tranchant  
Cortante

5 mm

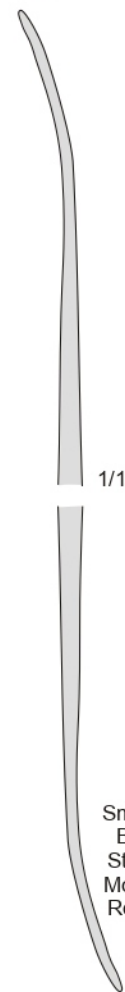

Smussa  
Blunt  
Stumpf  
Mousse  
Romas

1/1



HOWARTH  
HS-11570  
210 mm

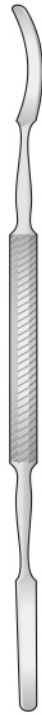

MC DONALD  
HS-11571  
190 mm

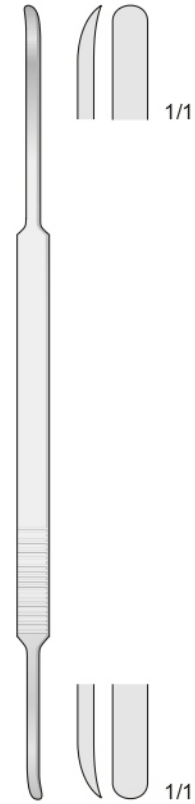

MCKENTY  
HS-11572  
220 mm

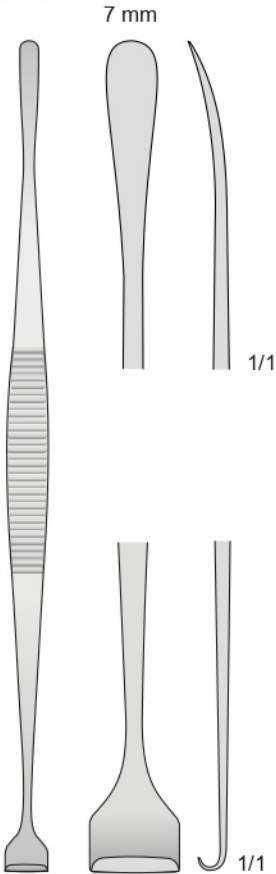

HURD  
HS-11573-1  
220 mm

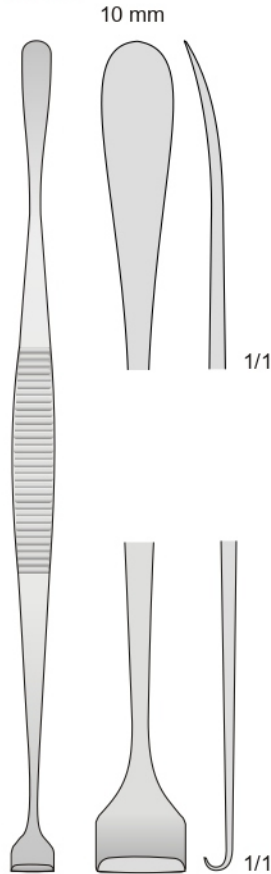

HURD  
HS-11573-2  
220 mm

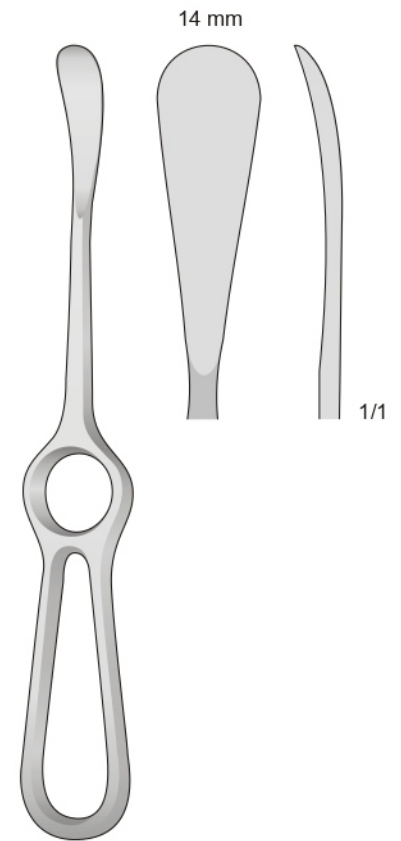

SEDILLOT  
HS-11574  
210 mm





Periosteal elevators  
Taglienti  
Sharp  
Scharf  
Tranchant  
Cortante

6 mm



1/1

OBWEGESER  
10-840-01  
175 mm

7 mm



1/1

OBWEGESER  
HS-11575-2  
175 mm

9 mm



1/1

OBWEGESER  
HS-11575-3  
175 mm

11 mm



1/1

OBWEGESER  
HS-11575-4  
175 mm



Sinistra, tagliente  
Left, sharp  
Links, Scharf  
À gauche, tranchant  
A la izquierda, cortante

Destra, tagliente  
Right, sharp  
Rechts, Scharf  
À droite, tranchant  
A la derecha, cortante

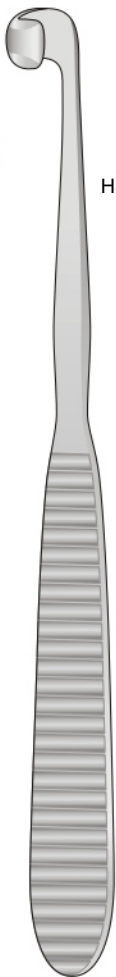

OBWEGESER  
HS-11576  
190 mm



5 mm



HS-11577-1  
200 mm

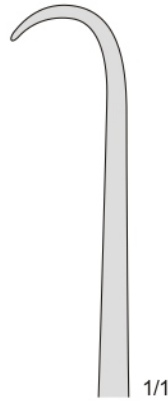

7 mm



HS-11577-2  
200 mm

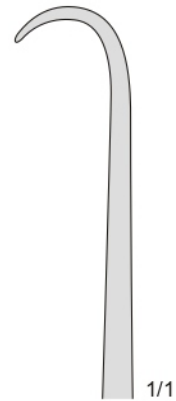

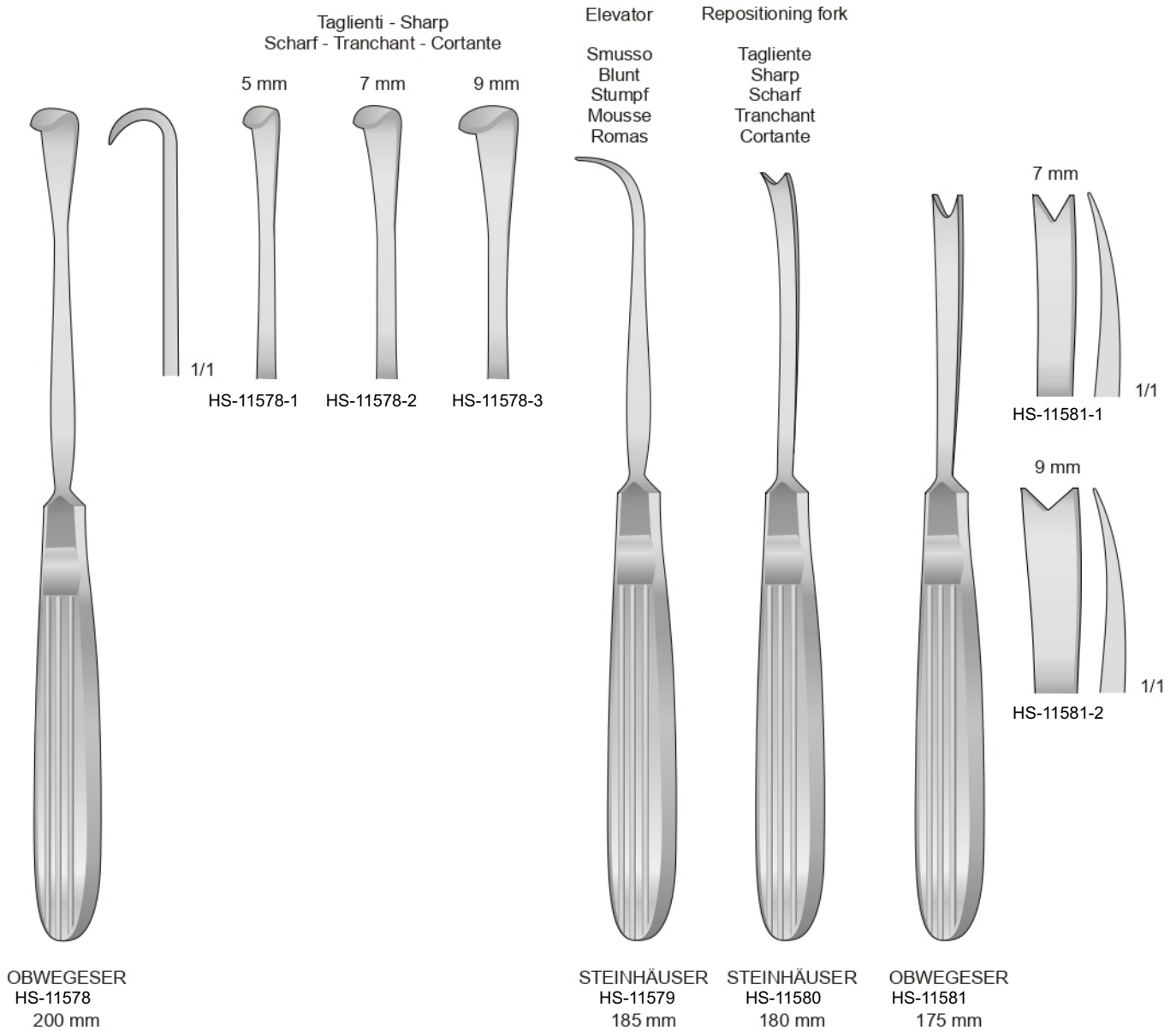



15 mm



CUSHING  
HS-11582  
190 mm



ADSON  
HS-11583  
170 mm

8 mm



HS-11583-1

7 mm



HS-11583-2

7 mm



HS-11583-3

7 mm



HS-11583-4

2,5 mm

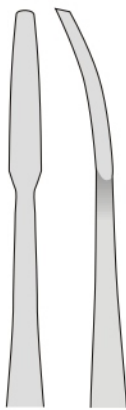

1/1

JOSEPH  
HS-11584-1  
170 mm

7 mm

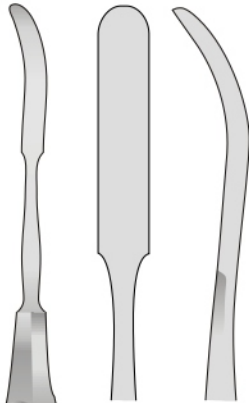

1/1

JOSEPH  
HS-11584-2  
180 mm

10 mm



MOLT  
HS-11585  
160 mm

10 mm



1/1

12 mm



1/1

15 mm



1/1



HENAHAN  
HS-11586  
175 mm

1/1

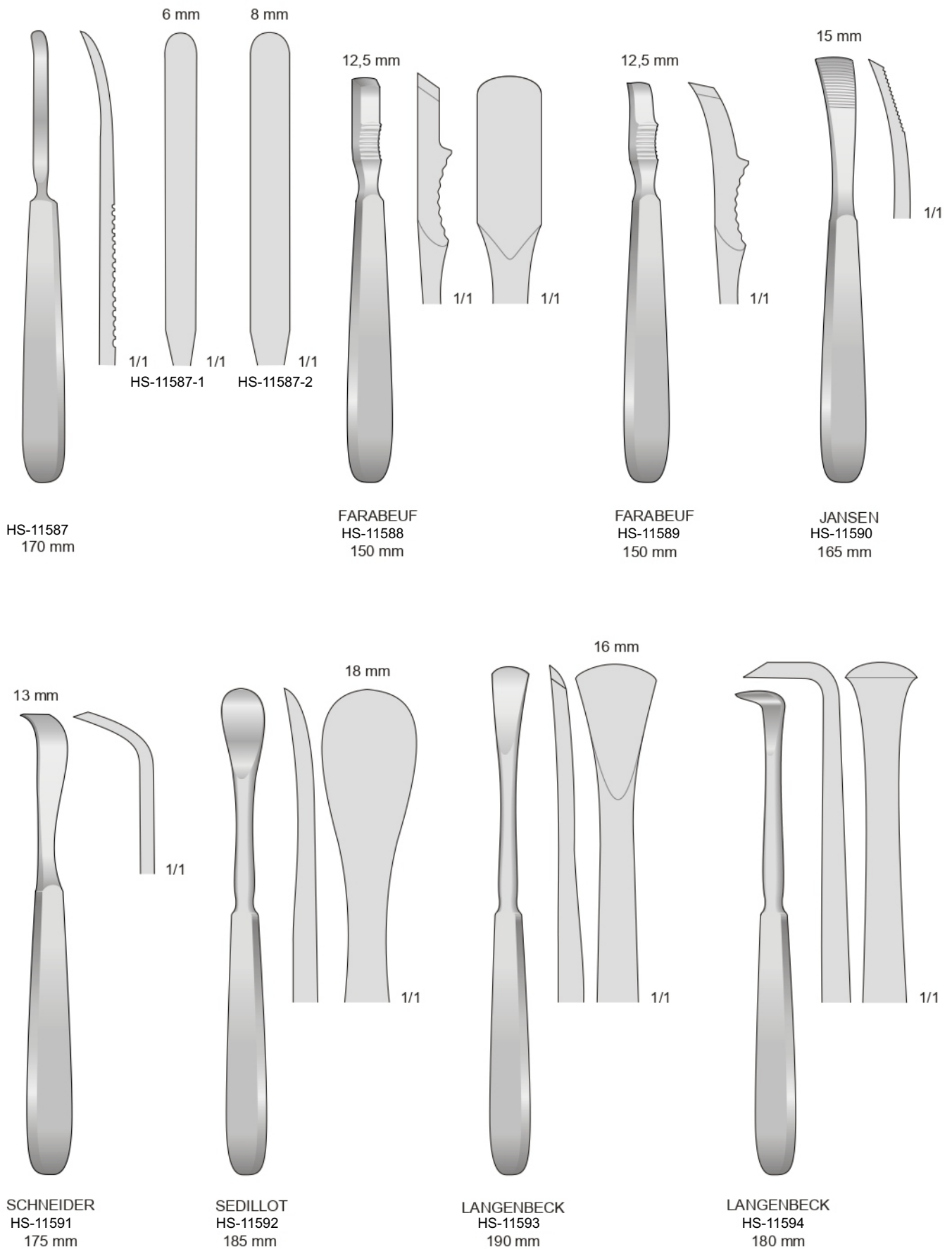



Sinus  
Hipophysectomia

Sinus and  
Hypophysectomy

Sinus und  
Hypophysectomie

Elevation e dissezion  
de apofisi zigomatica

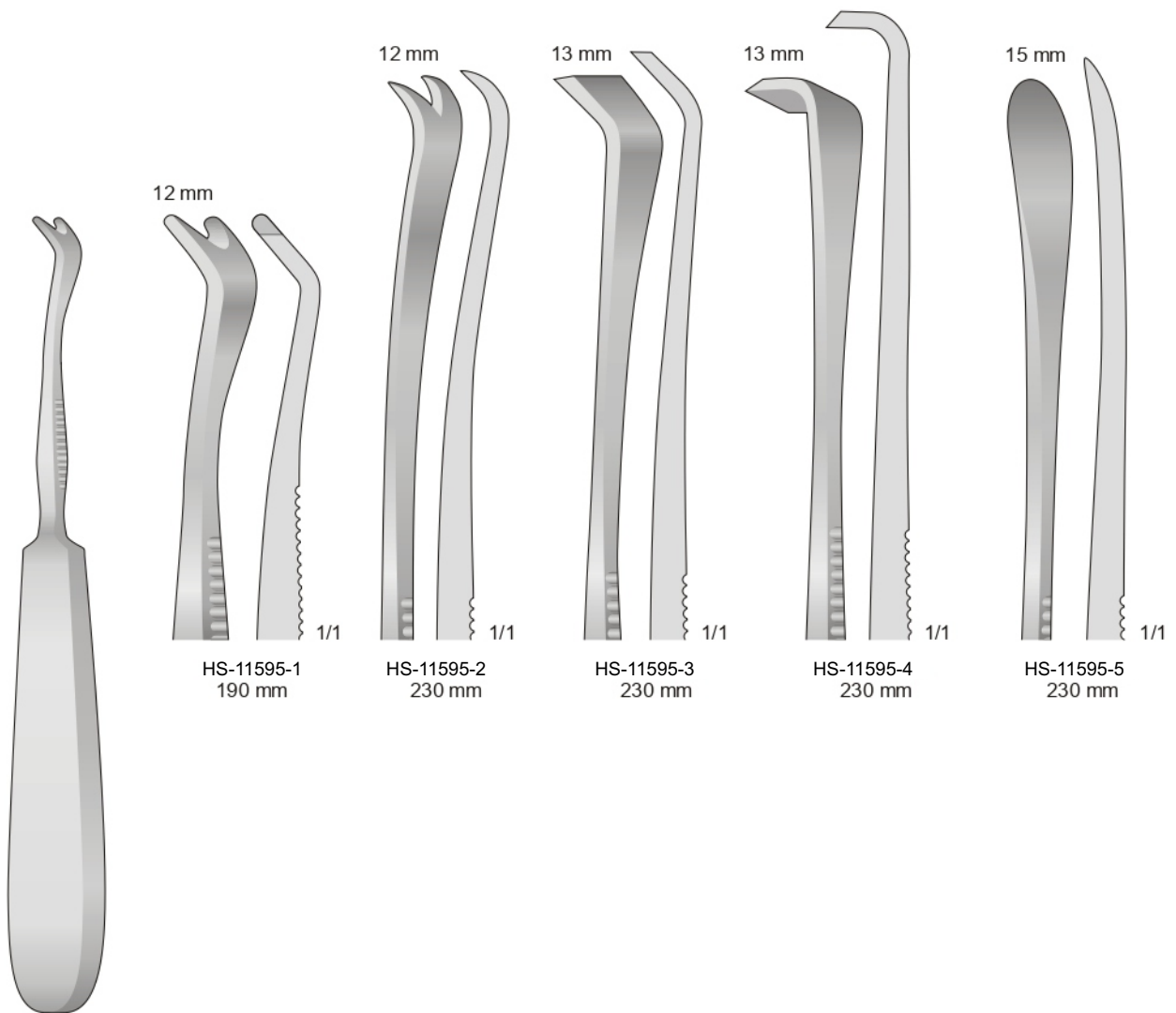

SEMB  
HS-11595

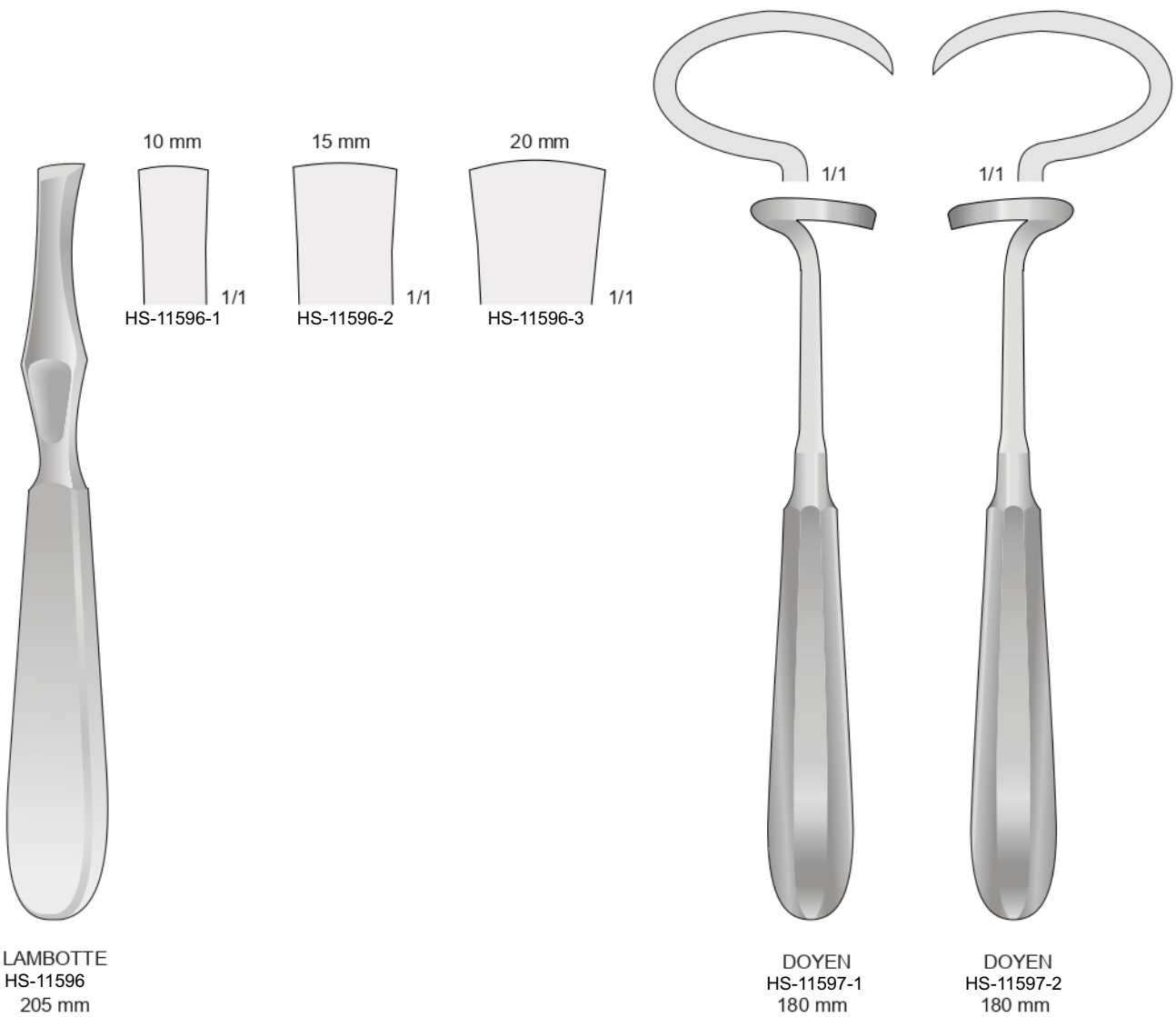



Con manico Ferrozell  
With Ferrozell handle  
Mit Ferrozellgriff  
Avec poignée en Ferrozell  
Con mango de Ferrozell

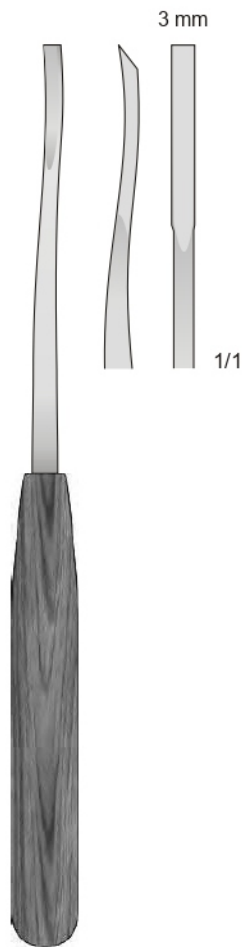

HS-11598-1  
180 mm

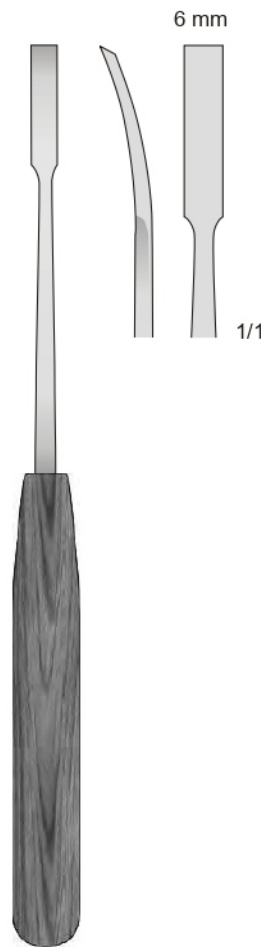

HS-11598-2  
190 mm



HS-11598-3  
190 mm



Con manico Ferrozell  
 With Ferrozell handle  
 Mit Ferrozellgriff  
 Avec poignée en Ferrozell  
 Con mango de Ferrozell

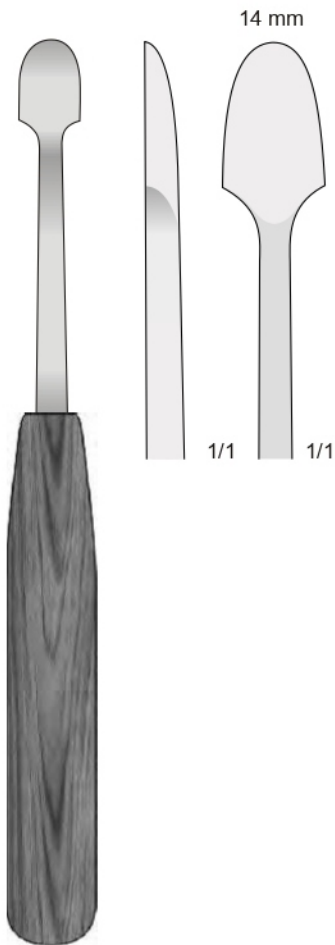

HS-11599-1  
 200 mm

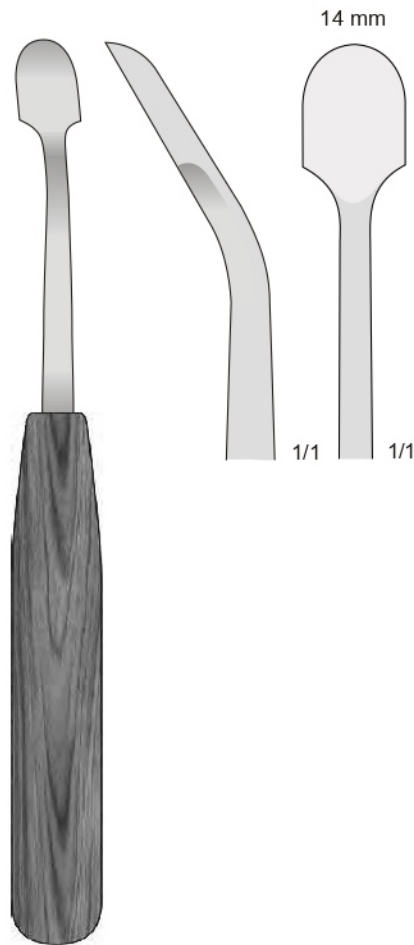

HS-11599-2  
 200 mm

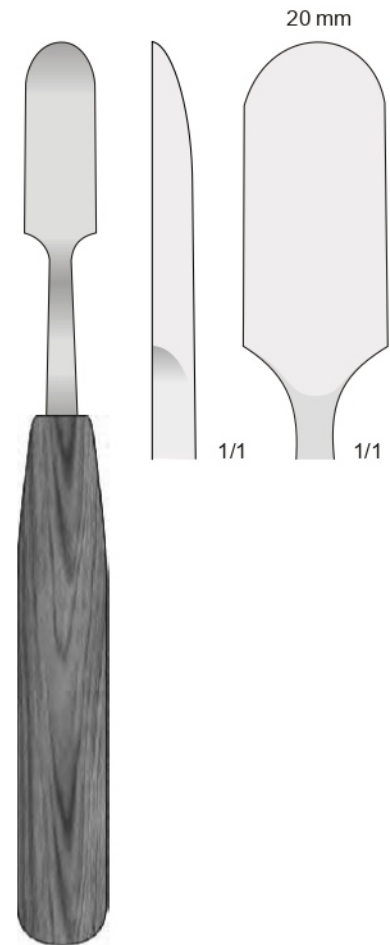

HS-11599-3  
 200 mm



Con manico Ferrozell  
With Ferrozell handle  
Mit Ferrozellgriff  
Avec poignée en Ferrozell  
Con mango de Ferrozell

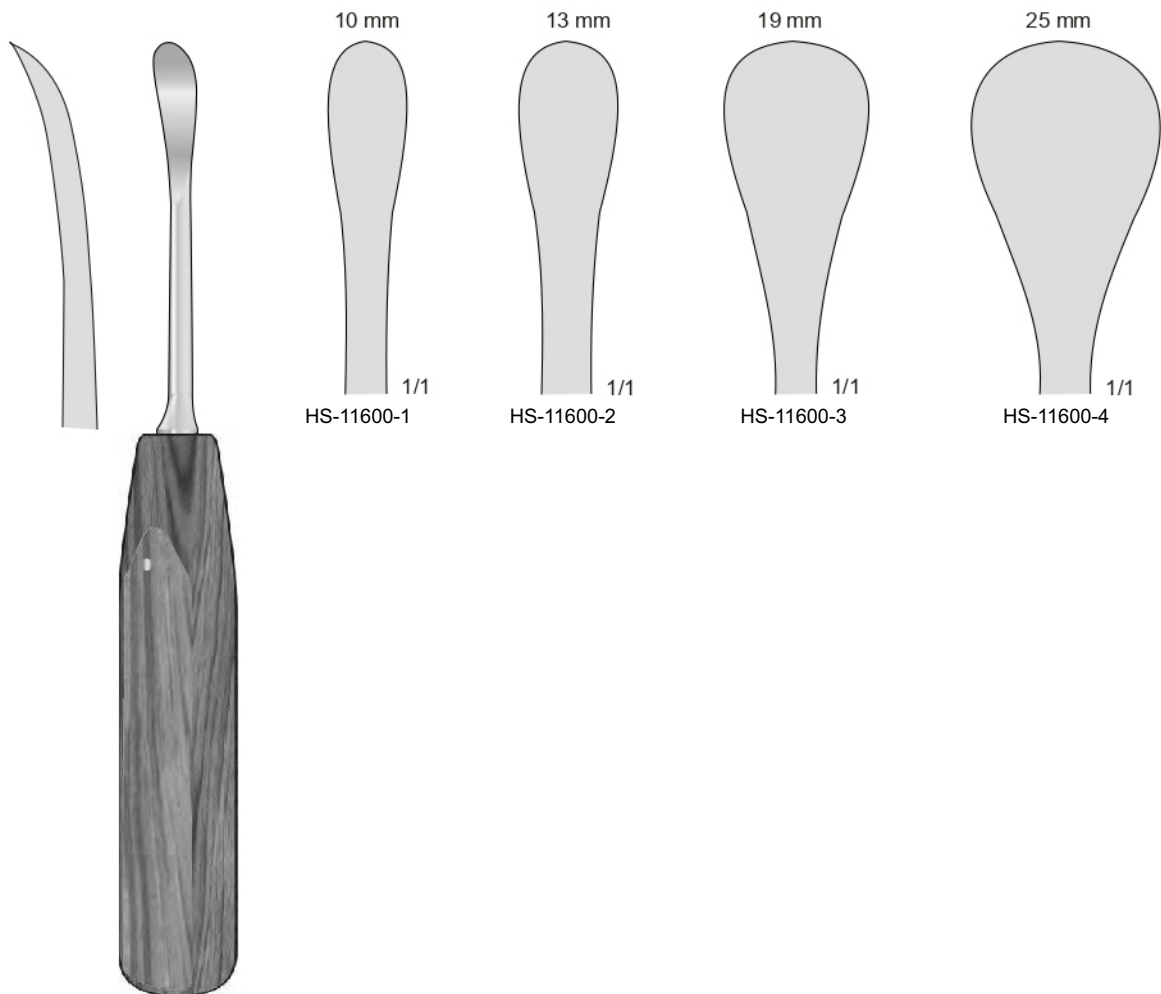

COBB  
HS-11600  
250 mm

Fig. 67

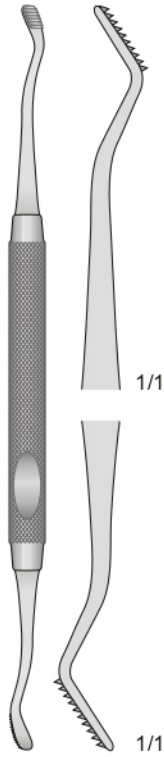

HOWARD  
HS-11601  
180 mm

Fig. 45

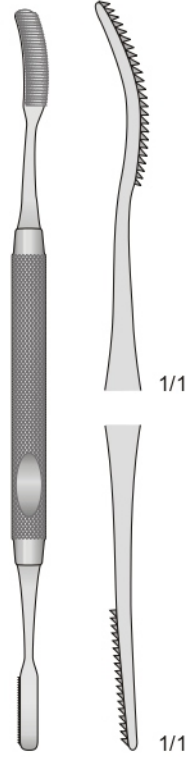

MILLER  
HS-11602  
185 mm

Fig. 52

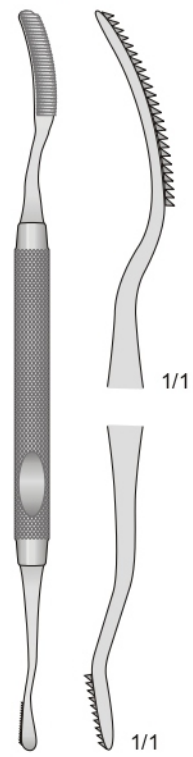

MILLER  
HS-11603  
180 mm

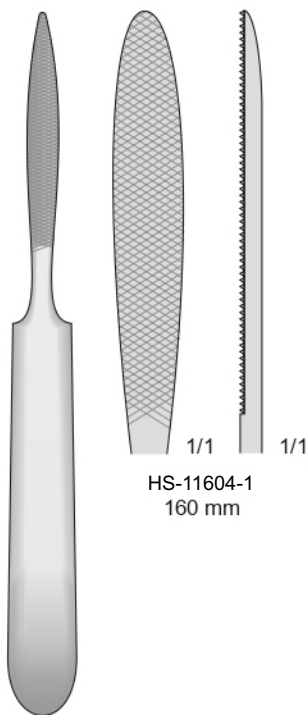

JOSEPH  
HS-11604  
160 mm

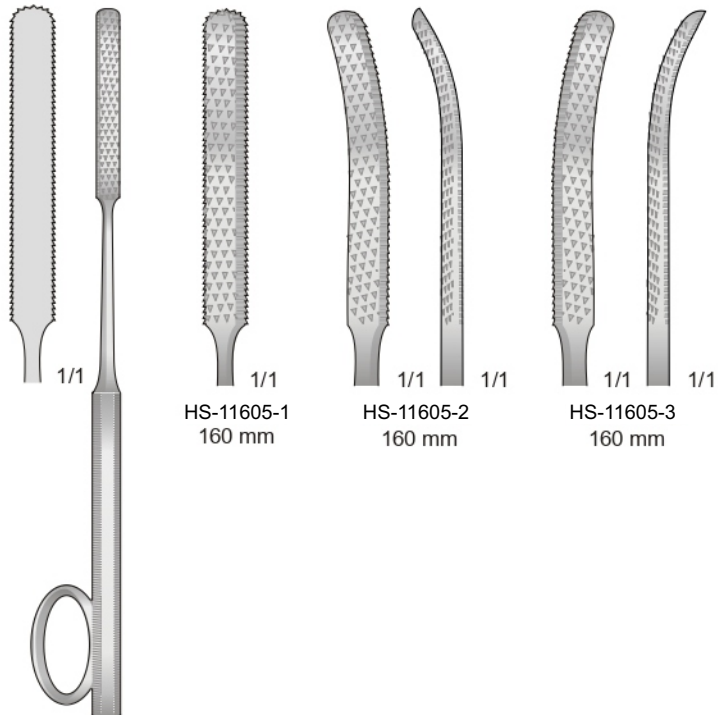

GALLAHER  
HS-11605  
160 mm

HS-11605-1  
160 mm

HS-11605-2  
160 mm

HS-11605-3  
160 mm

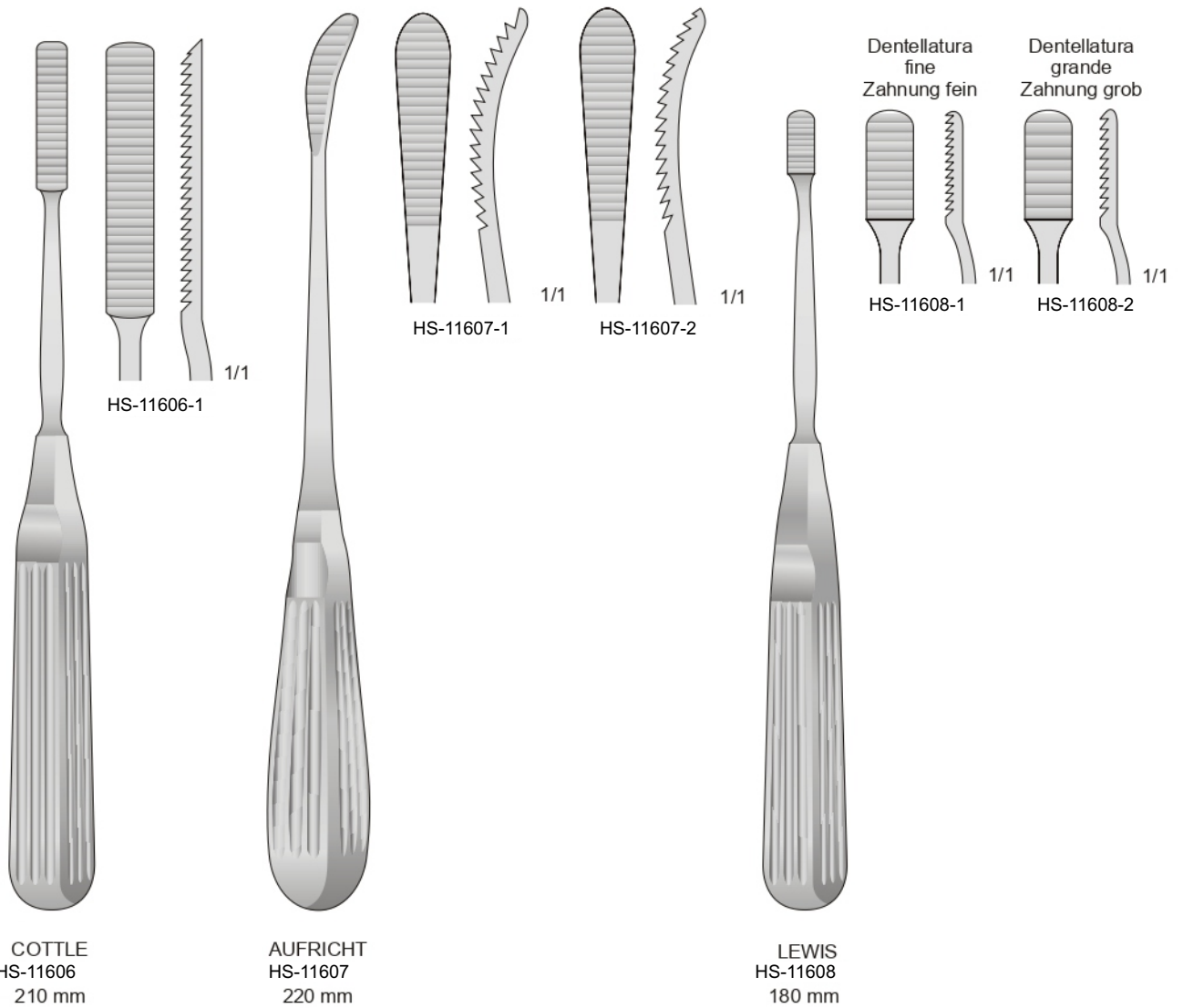

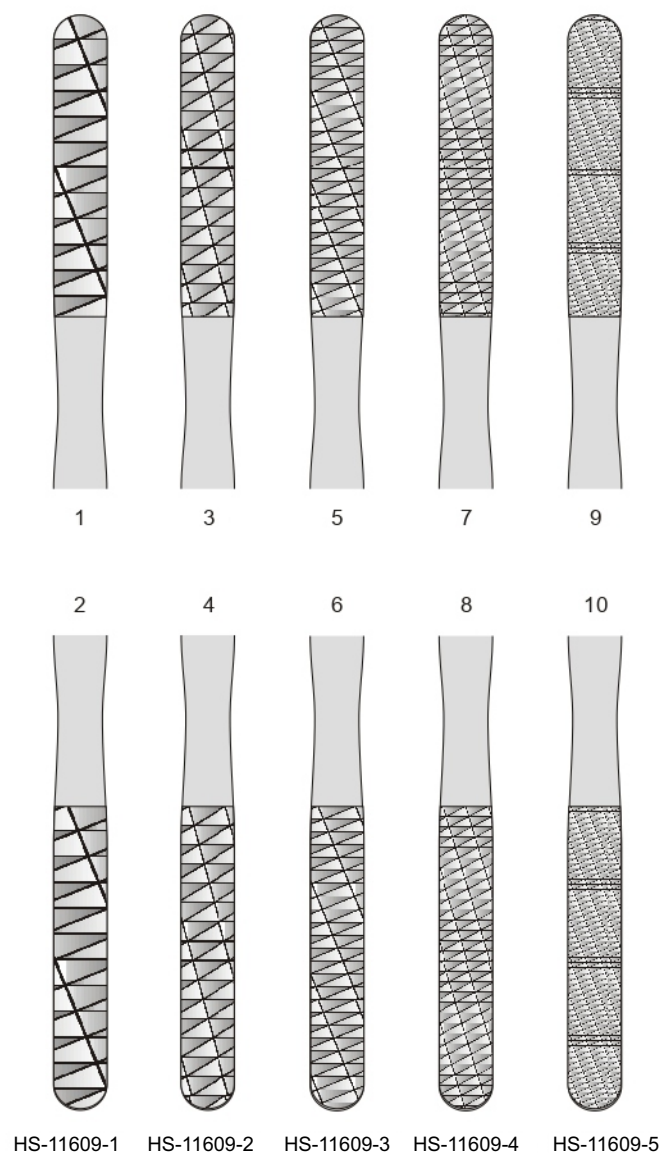
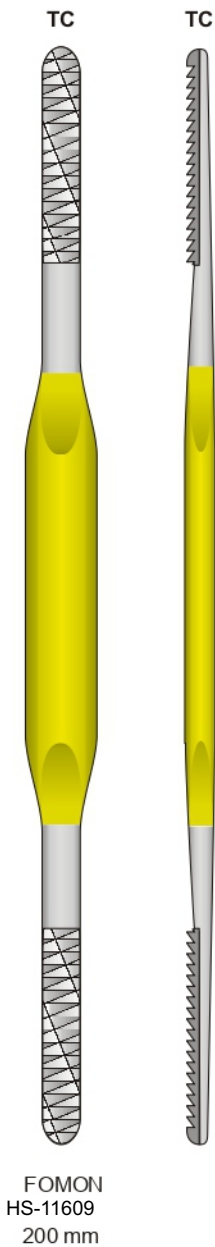

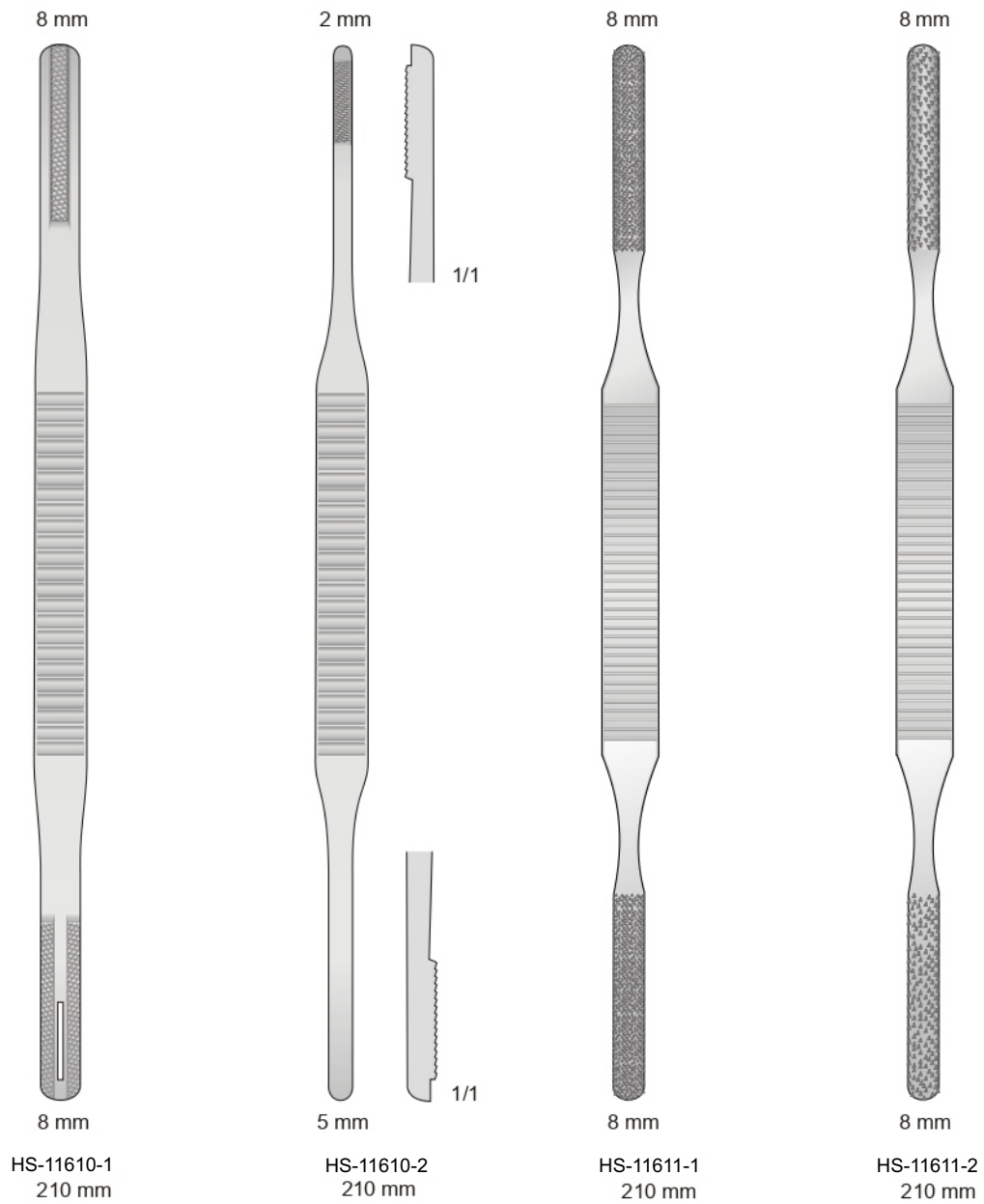

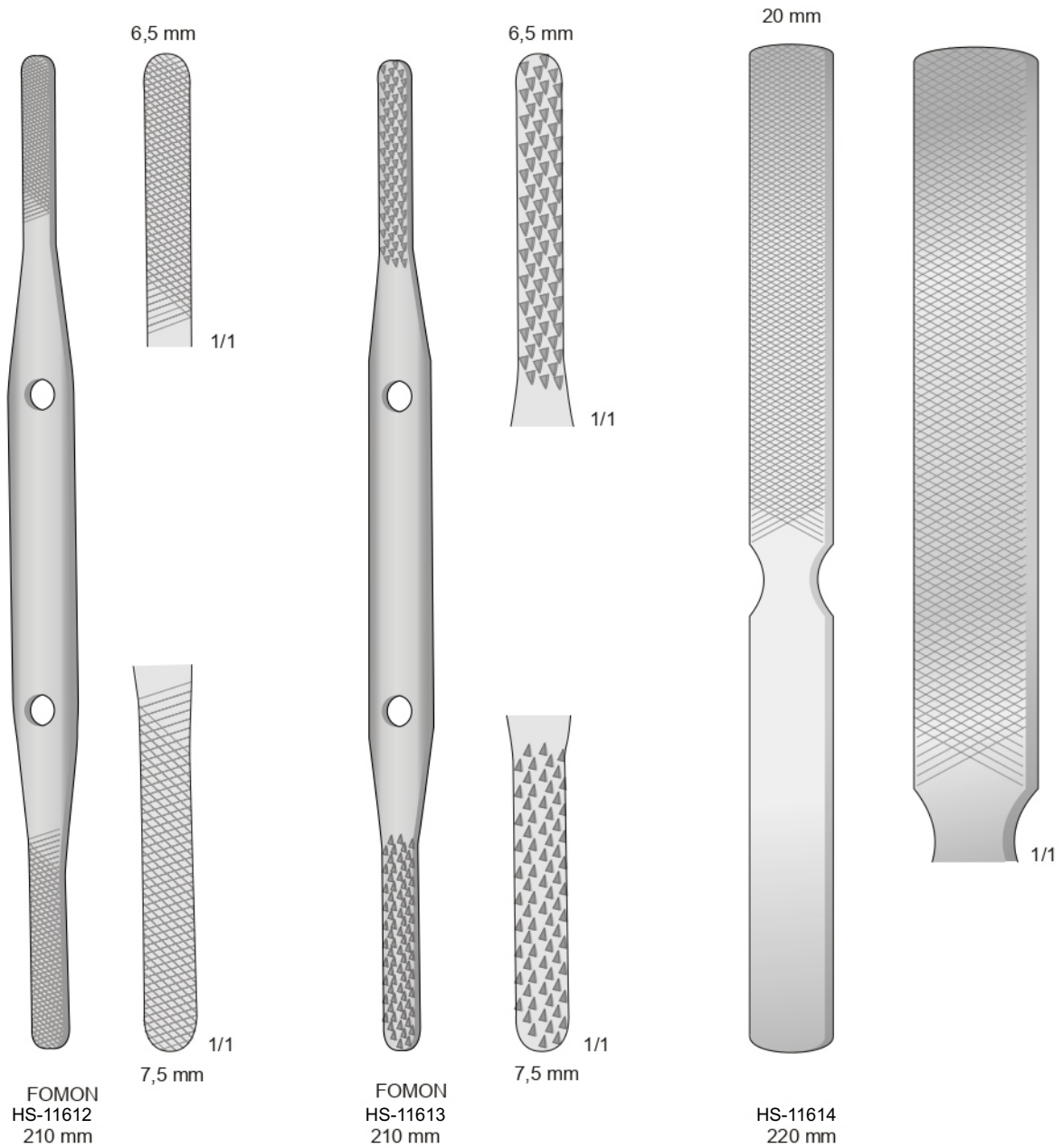

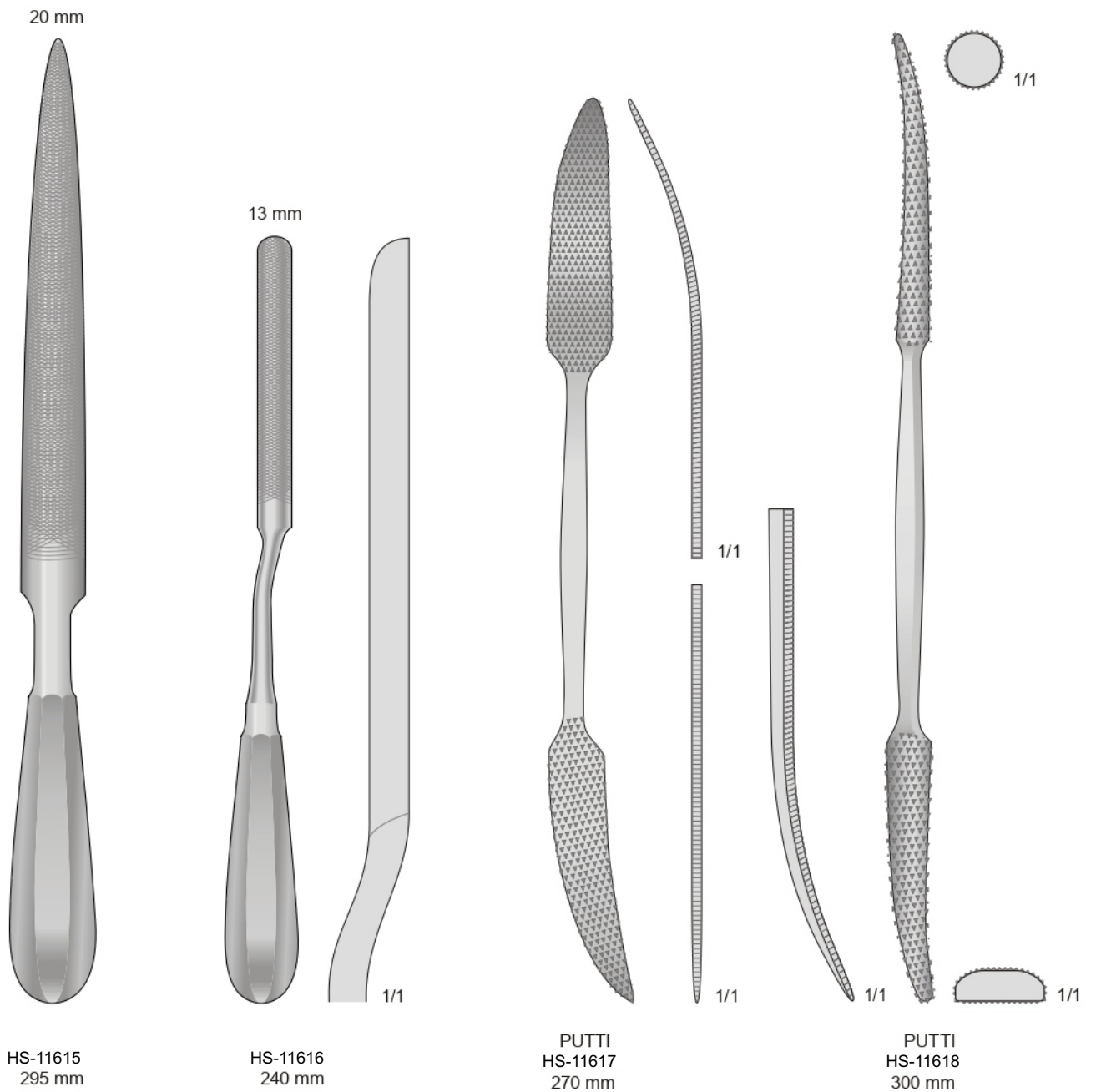



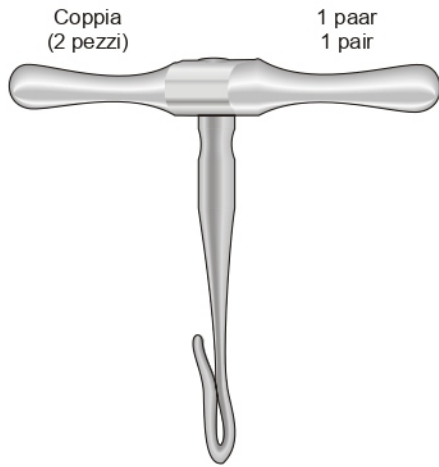

Coppia  
(2 pezzi)

1 paar  
1 pair

GIGLI  
HS-11619

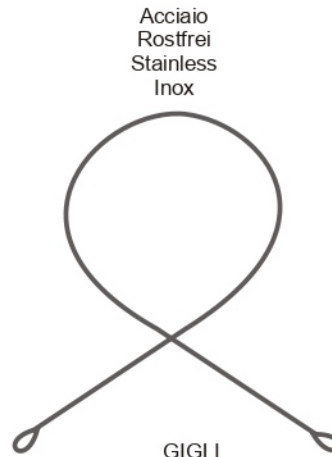

Acciaio  
Rostfrei  
Stainless  
Inox

GIGLI  
HS-11620-1  
300 mm  
HS-11620-2  
500 mm

Completa con 3 seghe  
Complete with 3 saws  
Komplett mit 3 Sägen  
Complet avec 3 scies  
Completo con 3 sierras

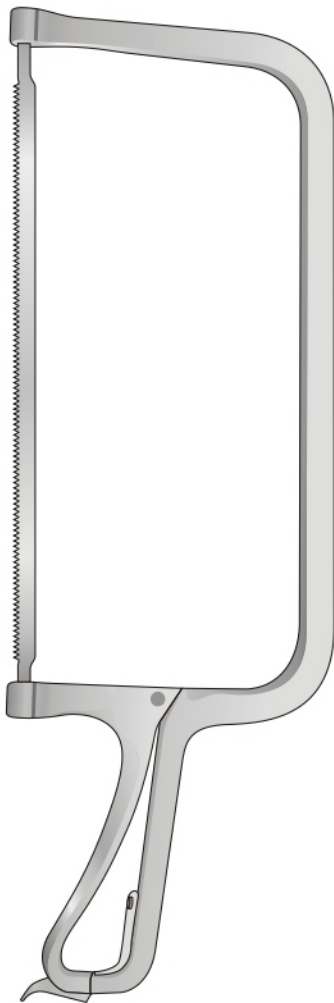

COLLIN  
HS-11621  
390 mm

Fig.1



Fig.2



Fig.3



HS-11621-1  
280 mm

HS-11621-2  
280 mm

HS-11621-3  
280 mm



LINDEMANN  
HS-11622  
200 mm



1/1



LANGENBECK  
HS-11623  
235 mm

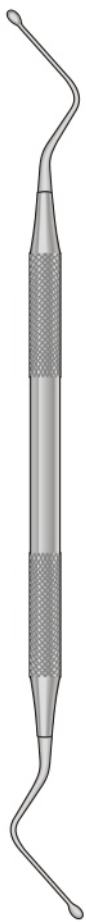

HEMINGWAY  
 HS-11624  
 175 mm



HEMINGWAY  
 HS-11625  
 175 mm



HEMINGWAY  
 HS-11626  
 175 mm



HEMINGWAY  
 HS-11627  
 175 mm

Fig. 1

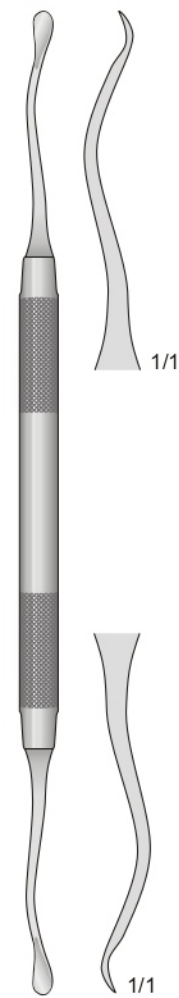

10-1350-02  
 200 mm

Fig. 2

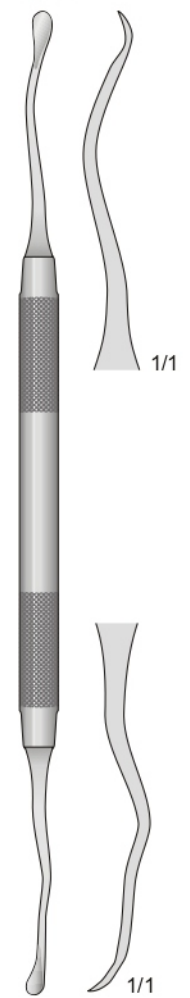

HS-11629  
 195 mm

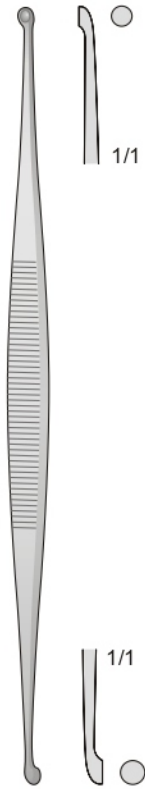

MARTINI  
 10-1360-14  
 140 mm

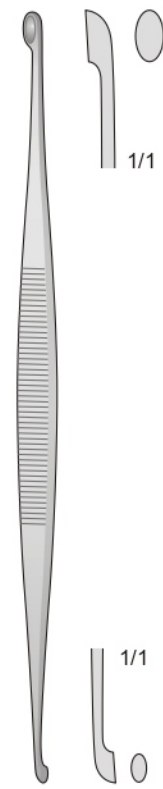

WILLIGER  
 10-1370-14  
 145 mm

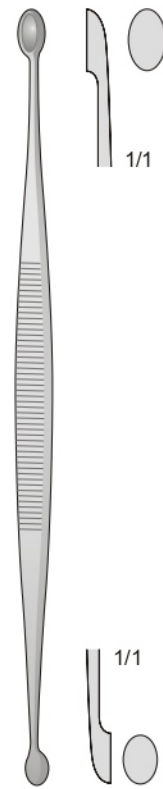

JACOBSON  
 10-1380-14  
 140 mm

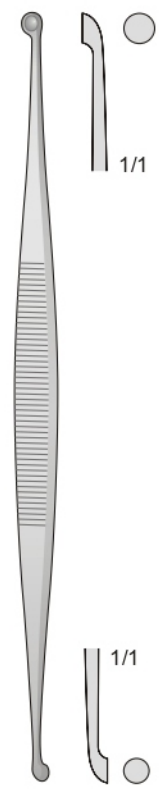

MARTINI  
 10-1390-14  
 140 mm

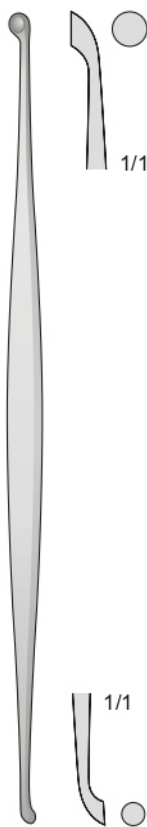

JANSEN  
 HS-11634  
 160 mm

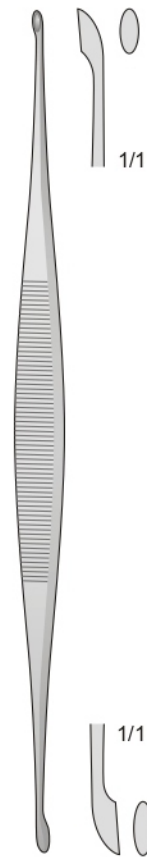

BARTH  
 HS-11635  
 180 mm

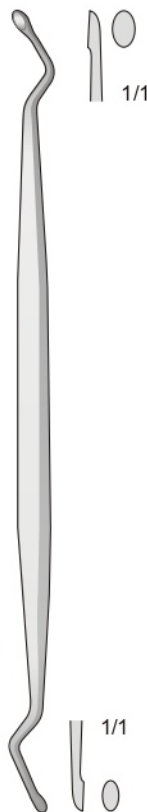

HS-11636  
 160 mm

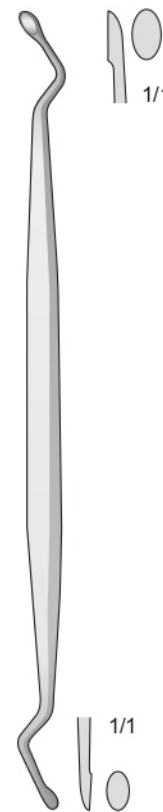

JANSEN  
 HS-11637  
 160 mm

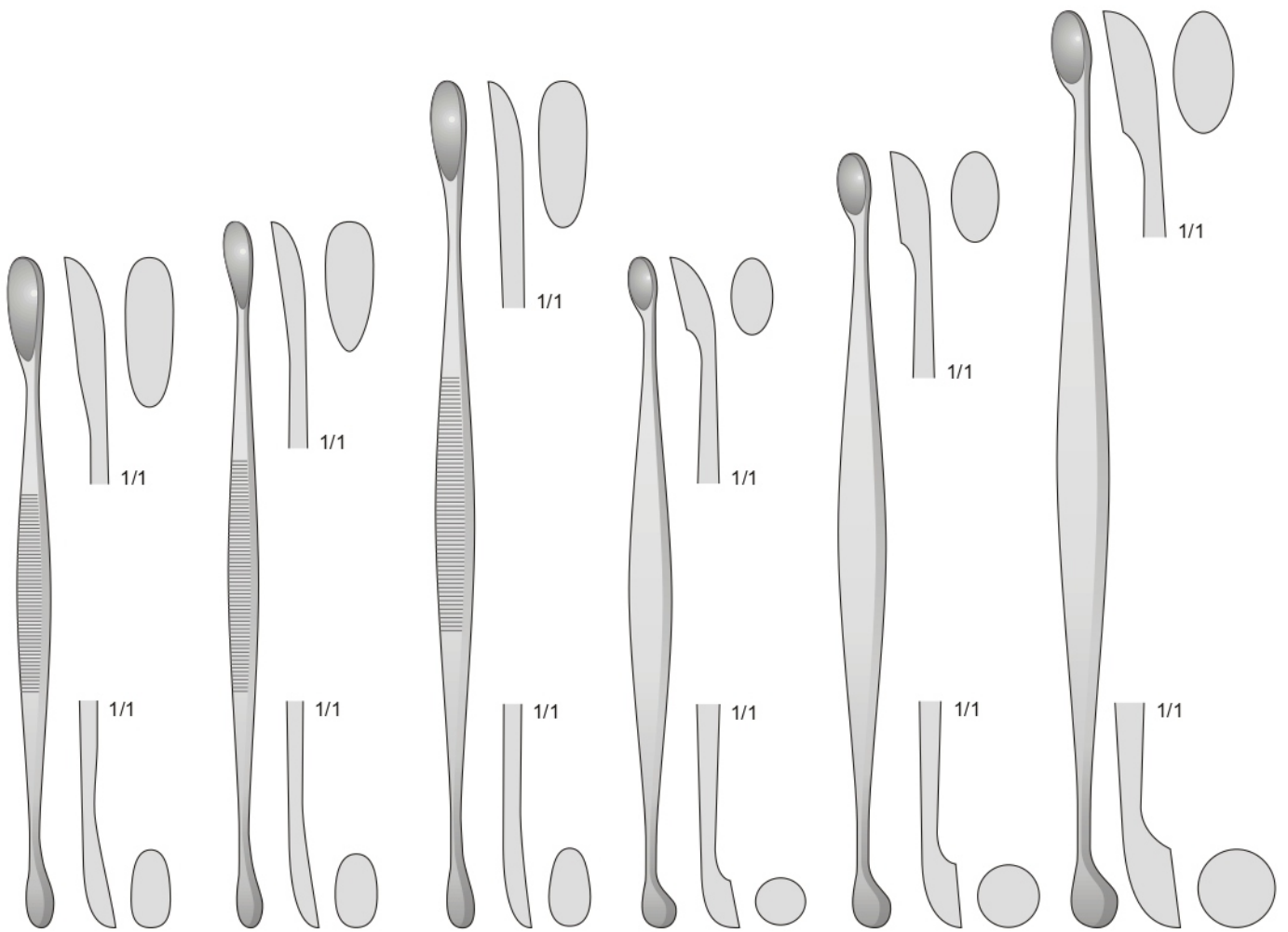

VOLKMANN  
 HS-11638  
 130 mm

VOLKMANN  
 HS-11639  
 145 mm

VOLKMANN  
 HS-11640  
 170 mm

HS-11641  
 130 mm

HS-11642  
 160 mm

HS-11643  
 200 mm

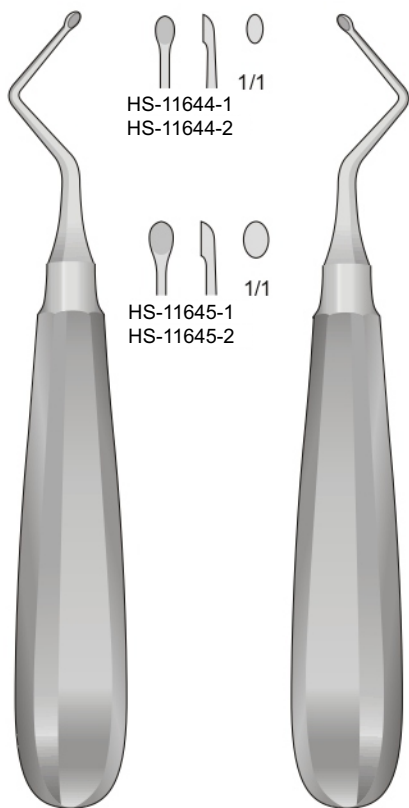

KERPEL  
HS-11644-1  
HS-11644-2  
145 mm

KERPEL  
HS-11645-1  
HS-11645-2  
145 mm

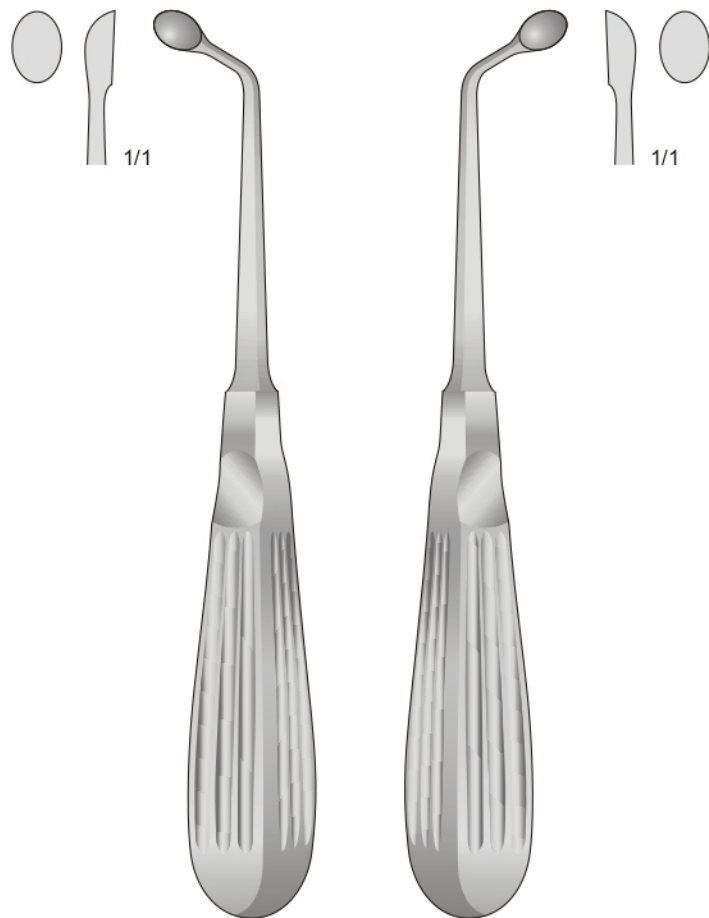

UFFENDORDE  
HS-11646-1  
170 mm

UFFENDORDE  
HS-11646-2  
170 mm

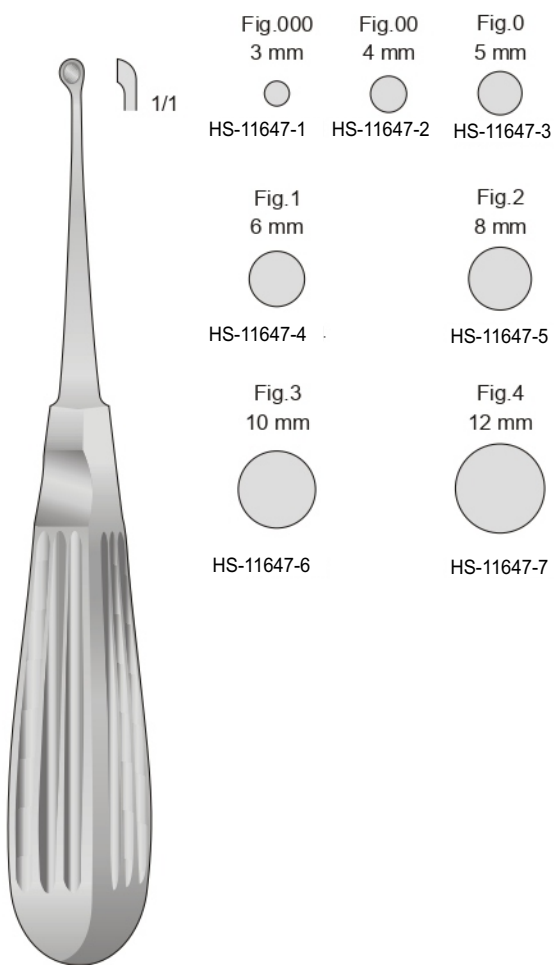

BRUNS  
HS-11647  
165 mm

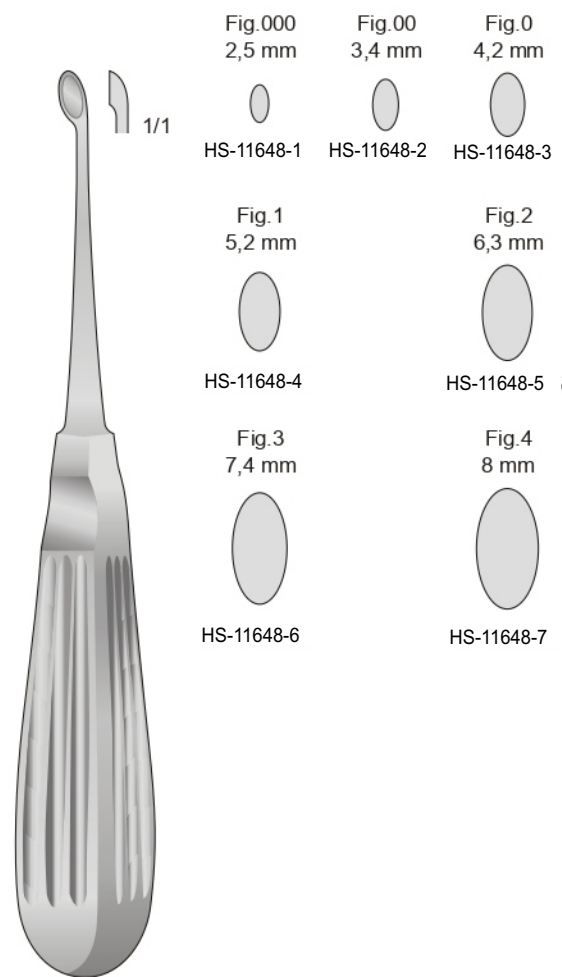

SCHEDE  
HS-11648  
170 mm



HS-11649  
180 mm

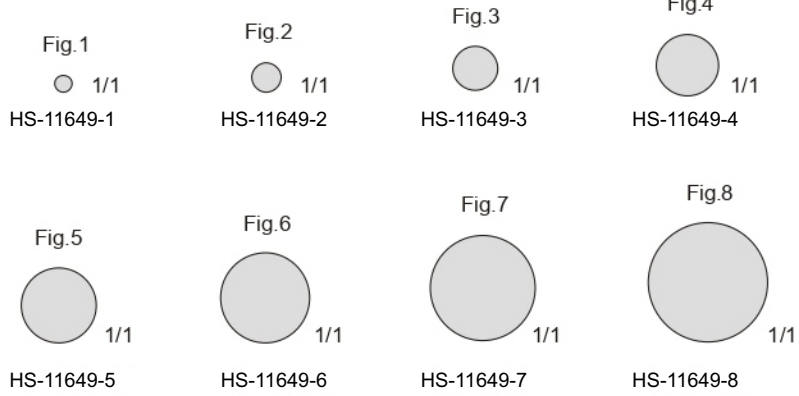

VOLKMANN  
HS-11650  
170 mm

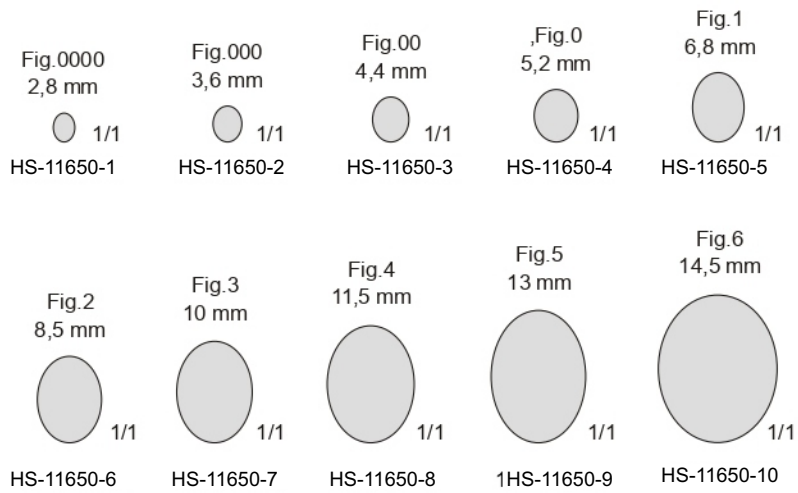



Fig.1  
HS-11651-1 1/1

Fig.2  
HS-11651-2 1/1

Fig.3  
HS-11651-3 1/1

Fig.4  
HS-11651-4 1/1

Fig.5  
HS-11651-5 1/1

Fig.6  
HS-11651-6 1/1

Fig.7  
HS-11651-7 1/1

Fig.8  
HS-11651-8 1/1

Fig.9  
HS-11651-9 1/1

HS-11651  
210 mm



Fig. 1  
HS-11652-1 1/1

Fig. 2  
HS-11652-2 1/1

Fig. 3  
HS-11652-3 1/1

Fig. 4  
HS-11652-1 1/1

Fig. 5  
HS-11652-2 1/1

Fig. 6  
HS-11652-3 1/1

HS-11652  
260 mm



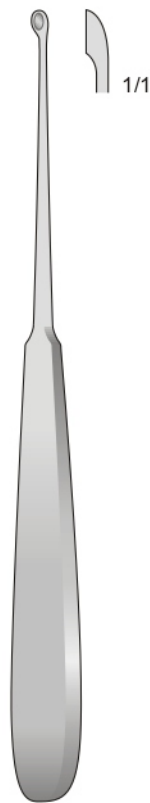

WILLIGER  
 HS-11653  
 170 mm

- Fig. 00  
3,4 mm  
1/1  
HS-11653-1
- Fig. 1  
5,2 mm  
1/1  
HS-11653-2

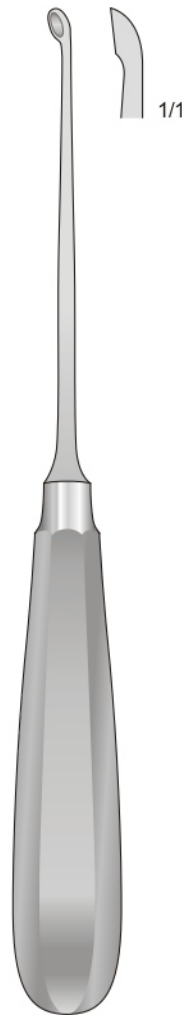

HALLE  
 HS-11654  
 215 mm

- Fig.00  
4,4 mm  
1/1  
HS-11654-1
- Fig.0  
5,2 mm  
1/1  
HS-11654-2
- Fig.1  
6,8 mm  
1/1  
HS-11654-3

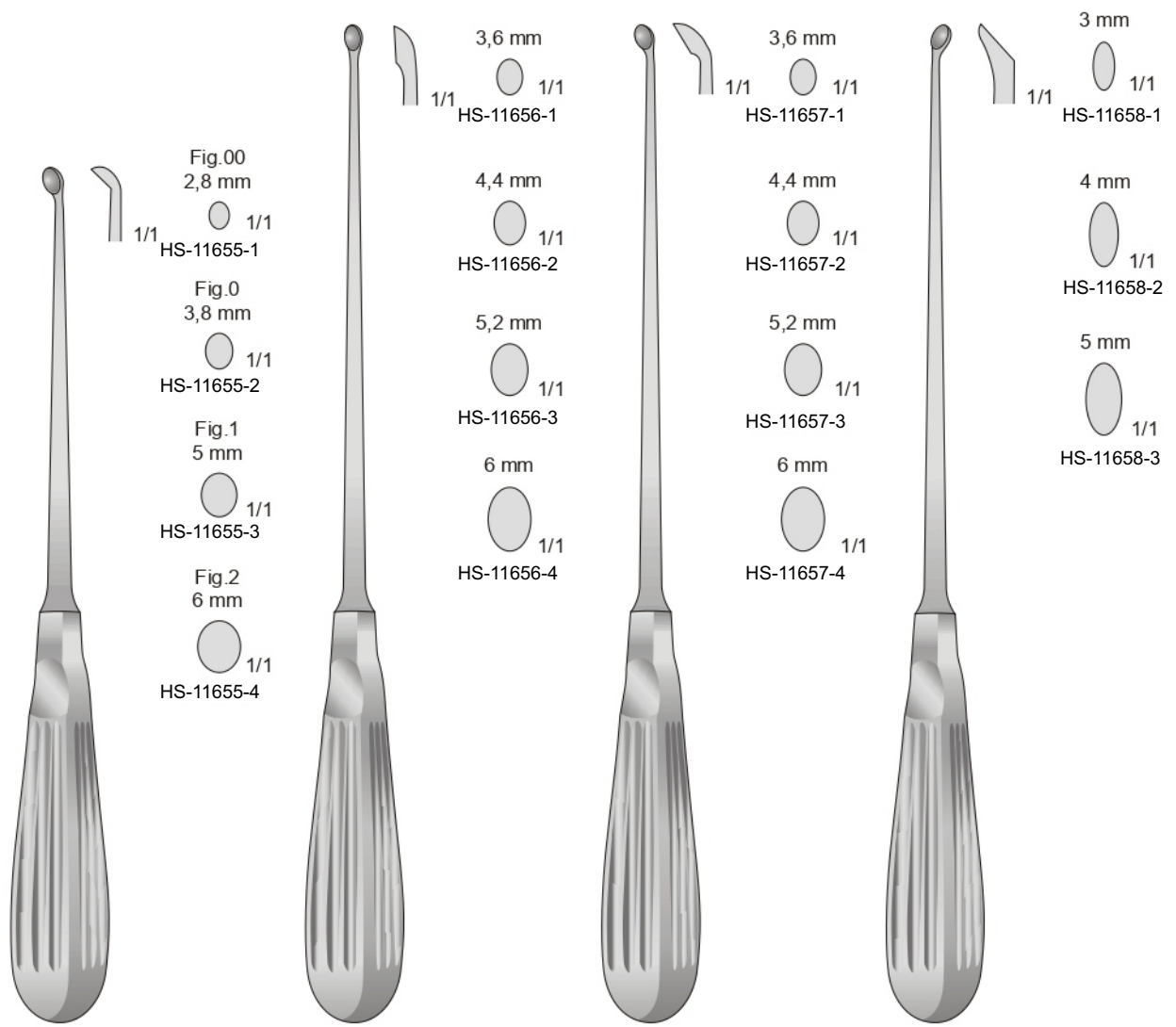

DAUBENSPECK  
HS-11655  
200 mm

HS-11656  
250 mm

HS-11657  
250 mm

BUSHE  
HS-11658  
250 mm

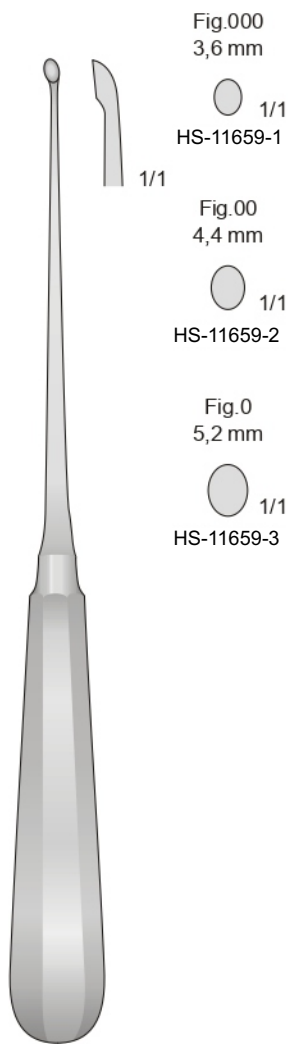

SIMON  
HS-11659  
235 mm

Fig.000  
3,6 mm  
1/1  
HS-11659-1

Fig.00  
4,4 mm  
1/1  
HS-11659-2

Fig.0  
5,2 mm  
1/1  
HS-11659-3



SIMON  
HS-11660  
240 mm

Fig.1  
6,8 mm  
1/1  
HS-11660-1

Fig.2  
8,5 mm  
1/1  
HS-11660-2

Fig.3  
10 mm  
1/1  
HS-11660-3

Fig.4  
11,5 mm  
1/1  
HS-11660-4

Fig.5  
13 mm  
1/1  
HS-11660-5

Fig.6  
14,5 mm  
1/1  
HS-11660-6

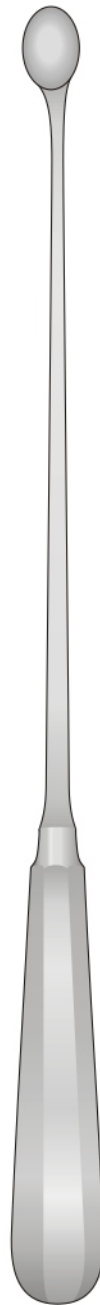

SCHRÖDER  
HS-11661  
310 mm

Fig.1  
6,8 mm  
1/1  
HS-11661-1

Fig.2  
8,5 mm  
1/1  
HS-11661-2

Fig.3  
10 mm  
1/1  
HS-11661-3

Fig.4  
11,5 mm  
1/1  
HS-11661-4

Fig.5  
13 mm  
1/1  
HS-11661-5

Fig.6  
14,5 mm  
1/1  
HS-11661-6

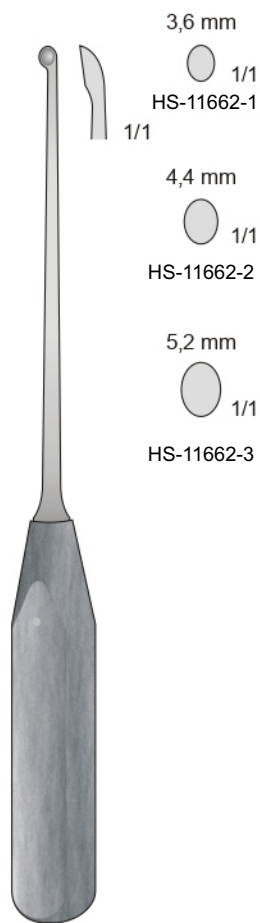

CASPAR  
HS-11662  
220 mm

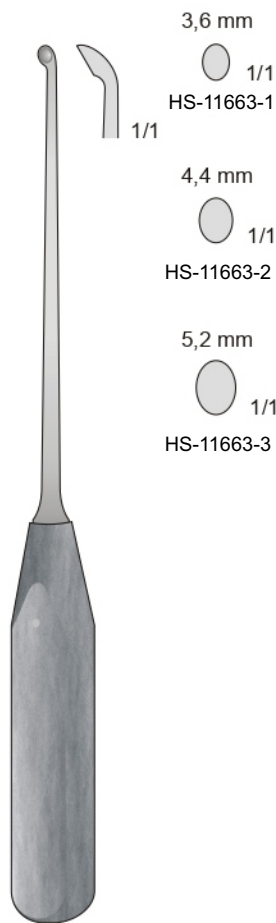

CASPAR  
HS-11663  
220 mm

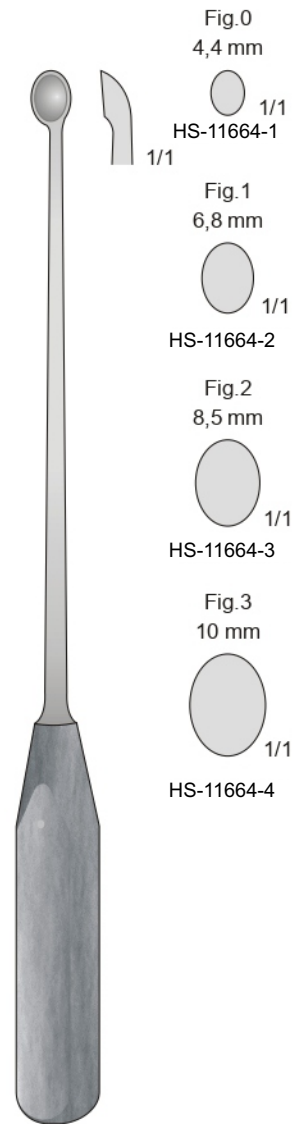

HS-11664  
270 mm

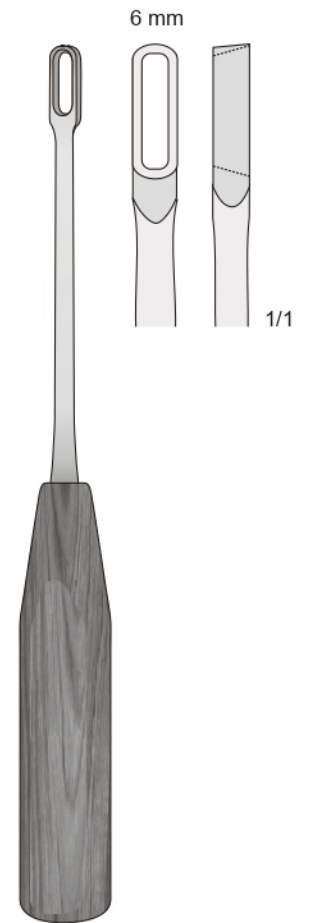

TESSIER  
HS-11665  
220 mm

Strumentario per protesi femorale  
 Femoral prosthesis instrumentation  
 Instruments pour prothese femorale

Con manico Ferrozell  
 With Ferrozell handle  
 Mit Ferrozellgriff  
 Avec poignée en Ferrozell  
 Con mango de Ferrozell

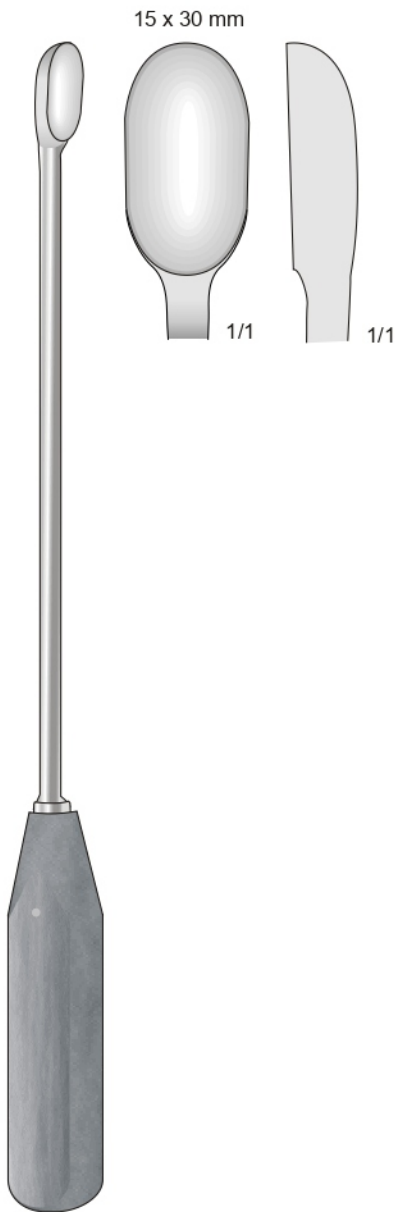

HS-11666  
 300 mm

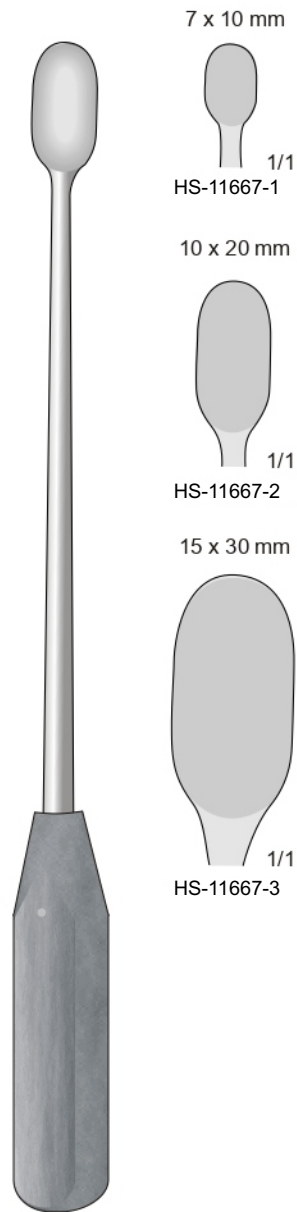

HS-11667  
 300 mm

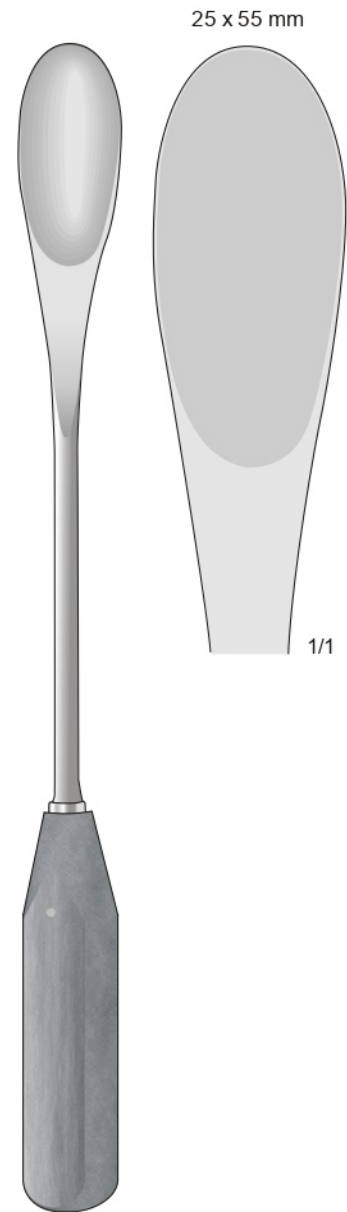

HS-11668  
 300 mm



# Health Fast Surgical

Surgical Manufacturer Company



+92 (342) 880 9017



+92 (342) 880 9017



info@healthfastsurgical.com



www.healthfastsurgical.com



Dogra Khurd, P.O Harrar Sialkot-51310 Pakistan.



ISO  
9001:2008

