

Tissue & Dressing Forceps

Surgical
INSTRUMENTS CATALOGUE



www.healthfastsurgical.com



Health Fast Surgical
Surgical Manufacturer Company

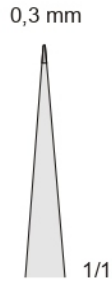

HS-10701-1
120 mm



VISE
HS-10701-2
135 mm

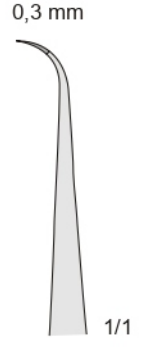

VISE
HS-10702
135 mm

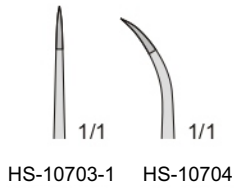

HS-10703
125 mm

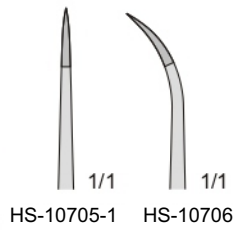

HS-10705
150 mm

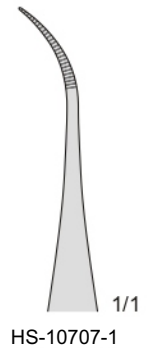

HS-10707
150 mm

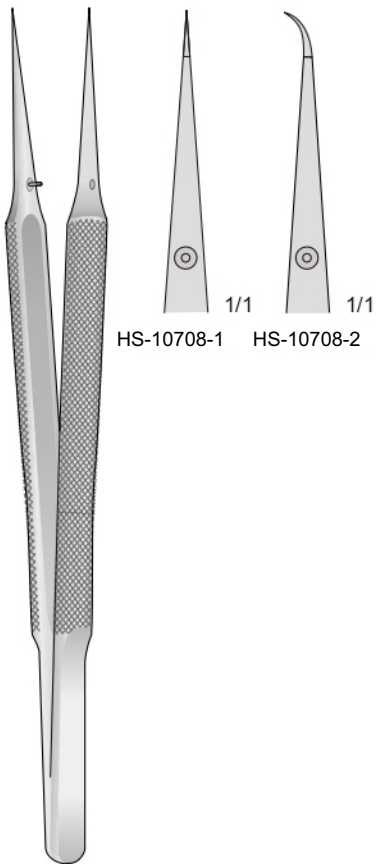

HS-10708
120 mm

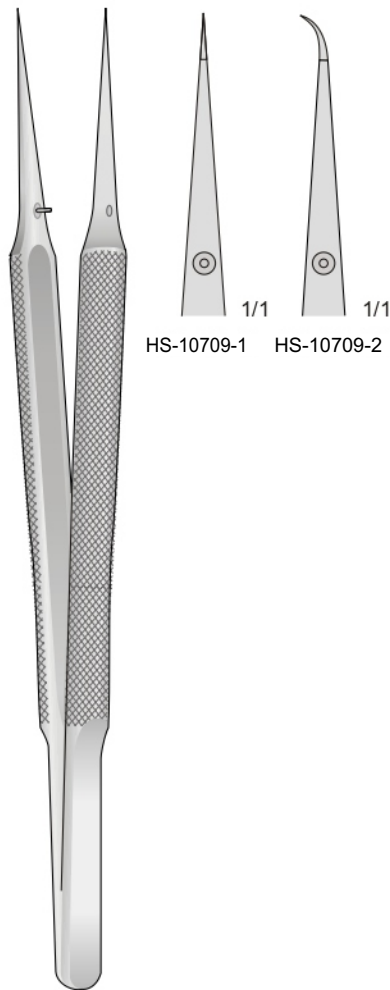

HS-10709
150 mm

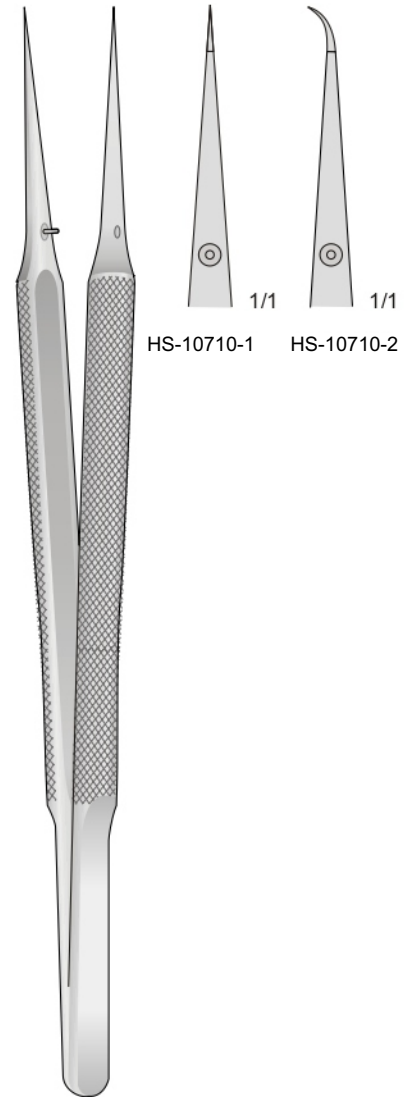

HS-10710
180 mm

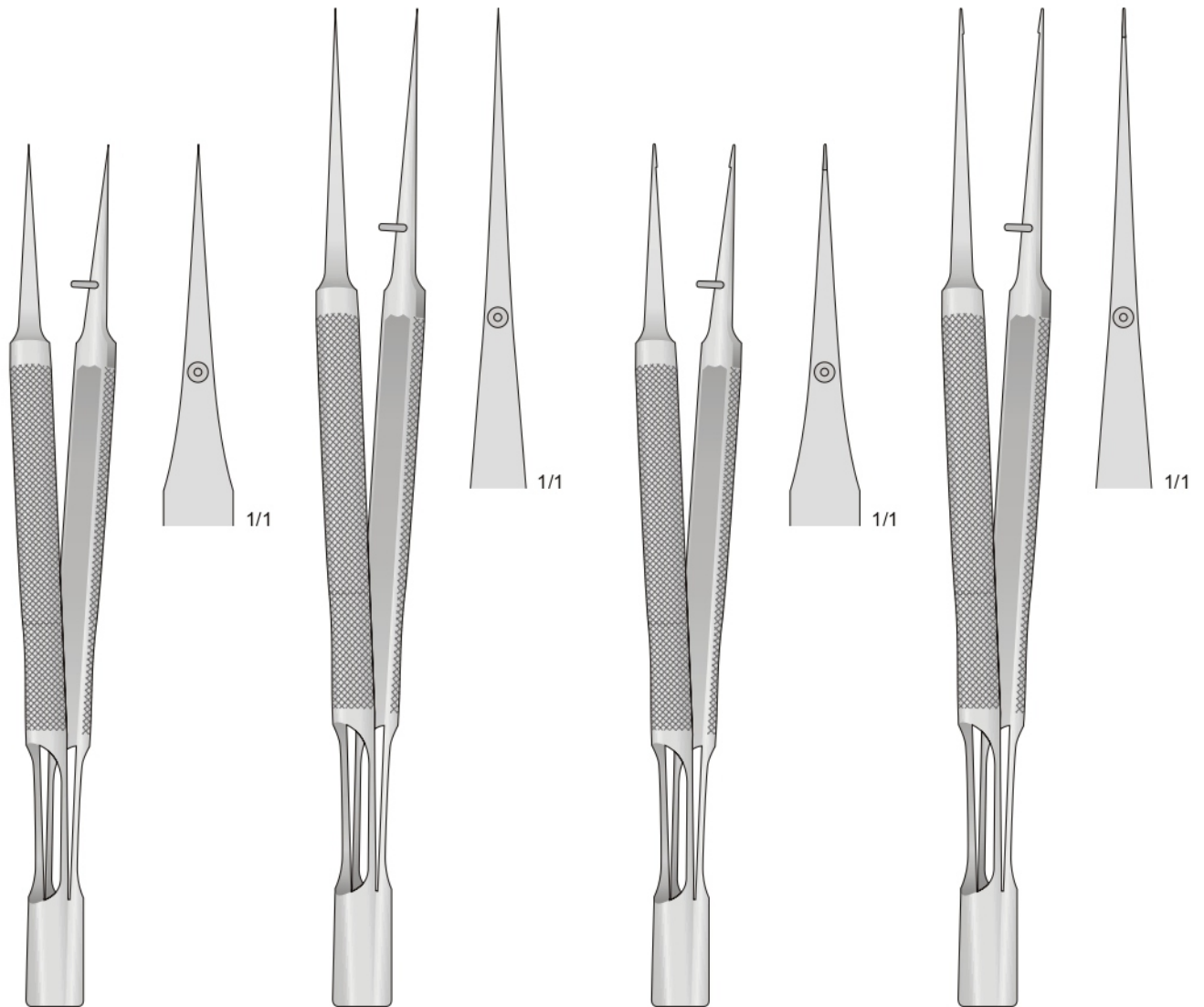
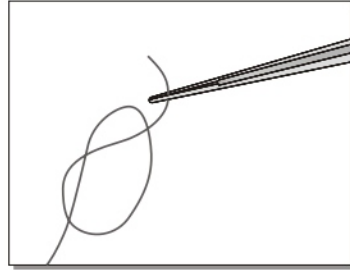

BROCK
 HS-10711
 130 mm

BROCK
 HS-10712
 150 mm

BROCK
 HS-10713
 130 mm

BROCK
 HS-10714
 150 mm

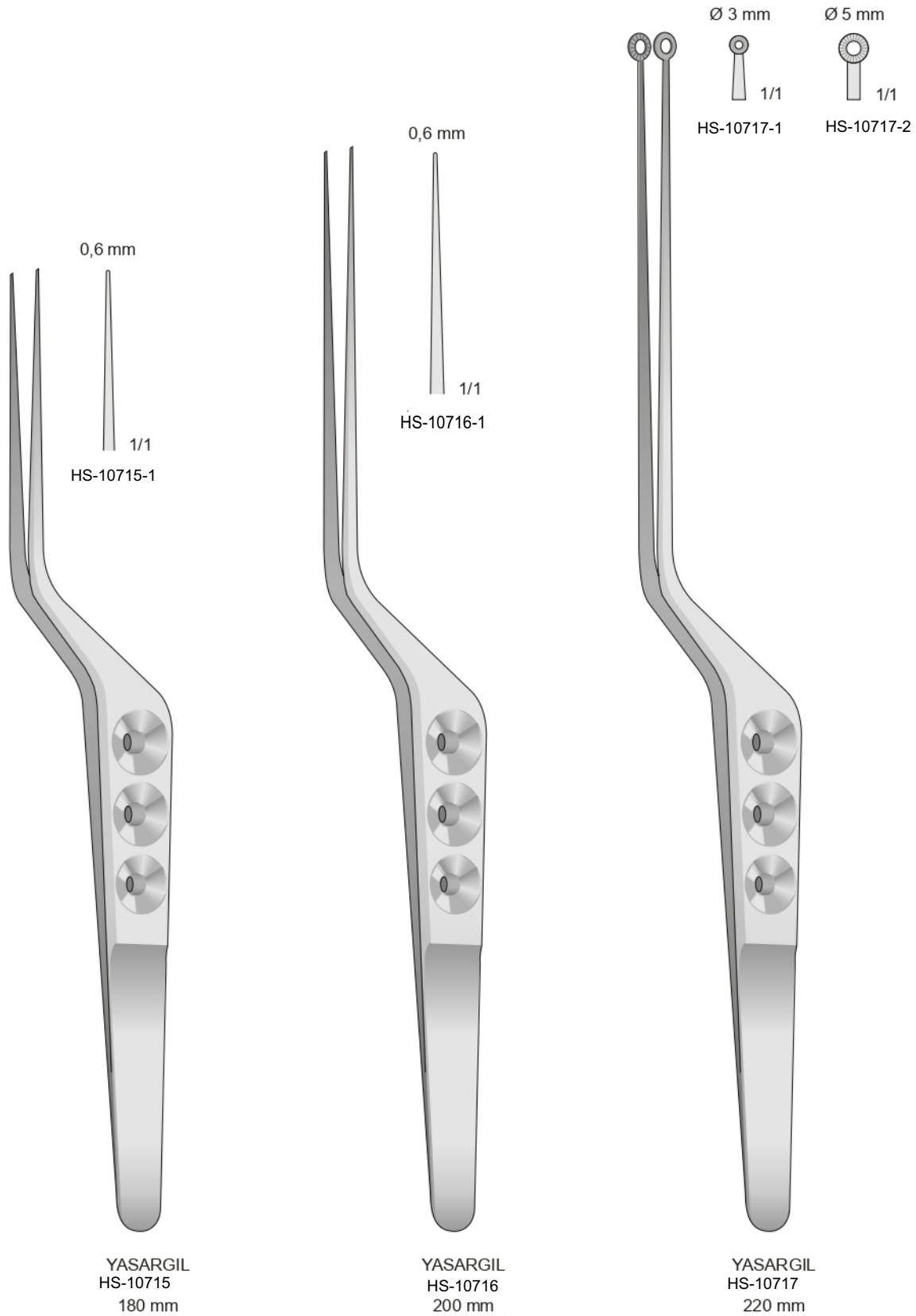

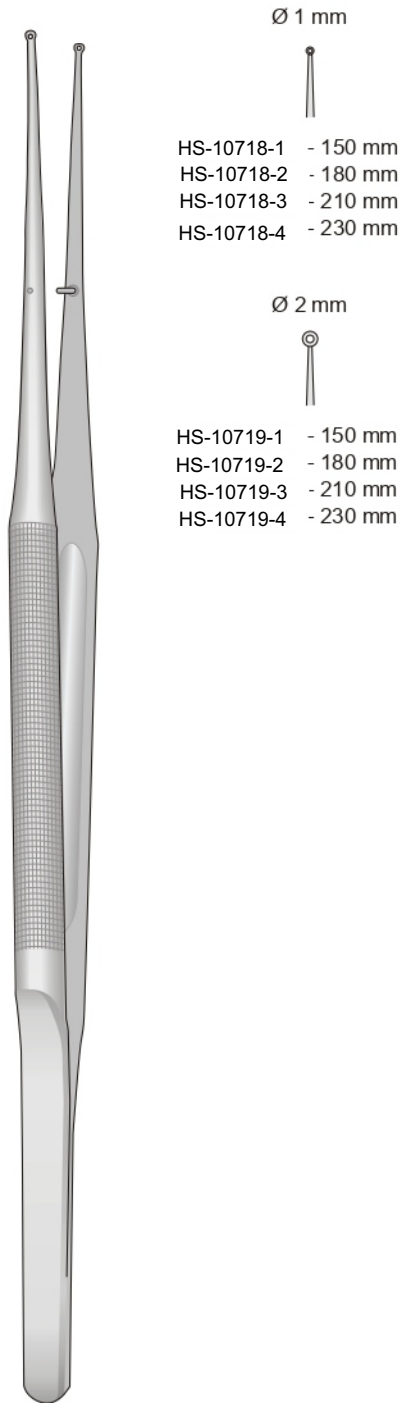

HS-10718

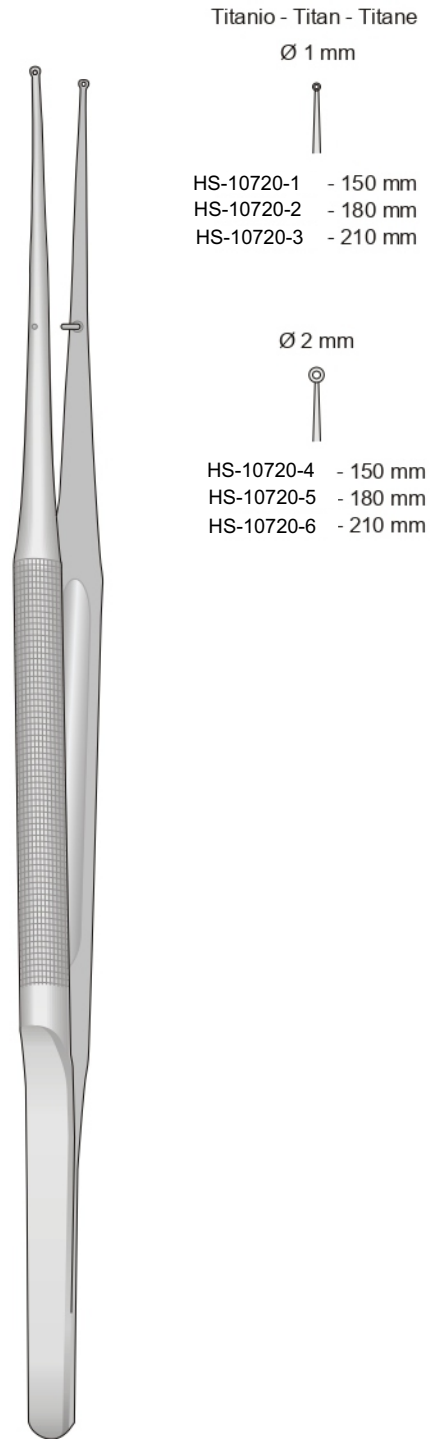

HS-10720

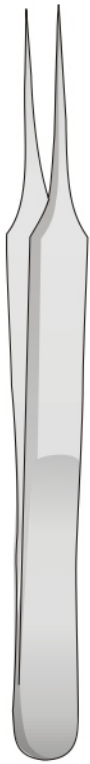

HS-10721
110 mm



HS-10721-1



HS-10721-2



HS-10722
110 mm



HS-10722-1



HS-10722-2



HS-10723
90 mm

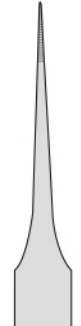

HS-10723-1



HS-10724

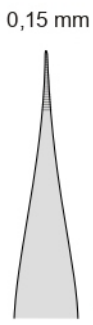

HS-10724-1
100 mm

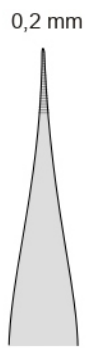

HS-10724-2
110 mm

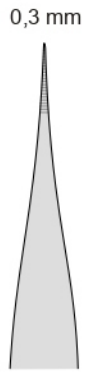

HS-10724-3
130 mm

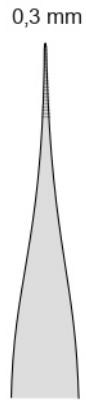

HS-10724-4
140 mm



HS-10725
115 mm



HS-10726
115 mm



Thumb and Tissue Forceps

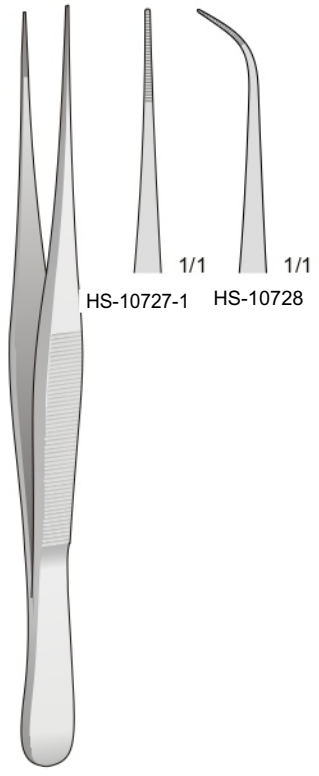

HS-10727
100 mm

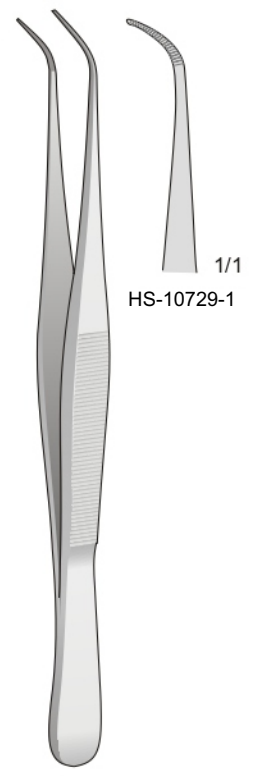

HS-10729
100 mm

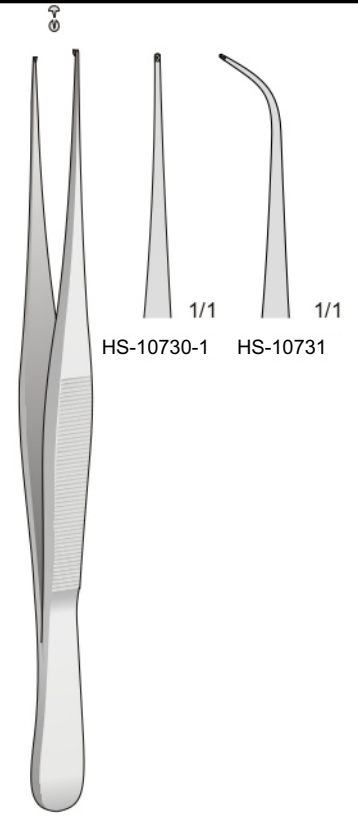

HS-10730
100 mm

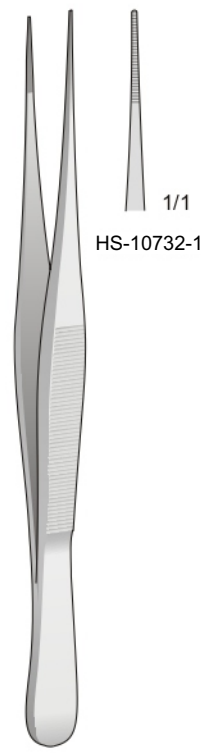

HS-10732
110 mm

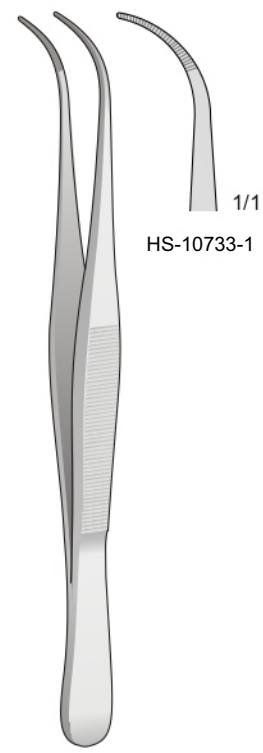

HS-10733
110 mm

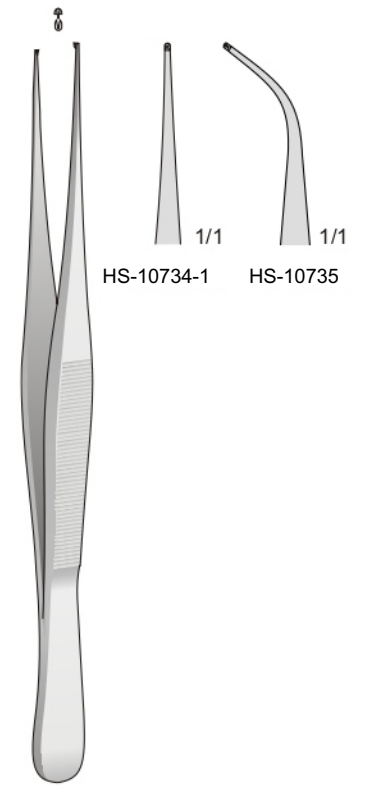

HS-10734
110 mm



Tissue Forceps



GRAEFE
HS-10736
100 mm



1/1
HS-10736-1



1/1
HS-10736-2



1/1
HS-10736-3



GRAEFE
HS-10737
100 mm



1/1
HS-10737-1



1/1
HS-10737-2



1/1
HS-10737-3

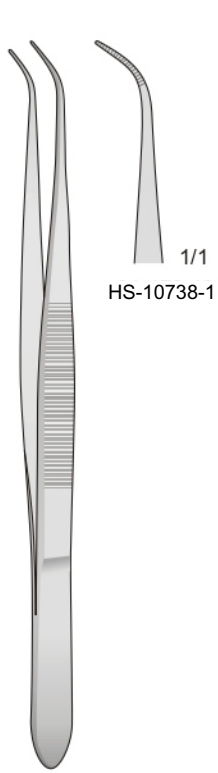

PERRY
HS-10738
125 mm

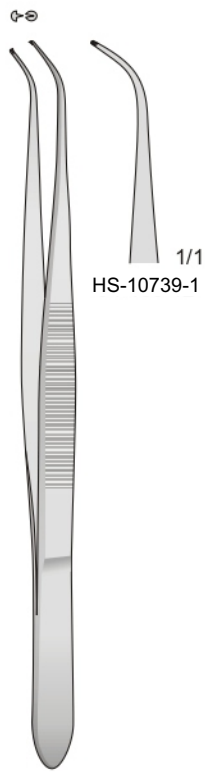

PERRY
HS-10739
125 mm



HS-10740

1x2 denti
0,2 mm
1/1
HS-10740-1
95 mm

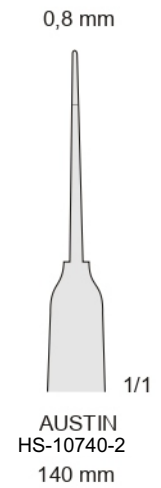

AUSTIN
HS-10740-2
140 mm



HS-10741
130 mm

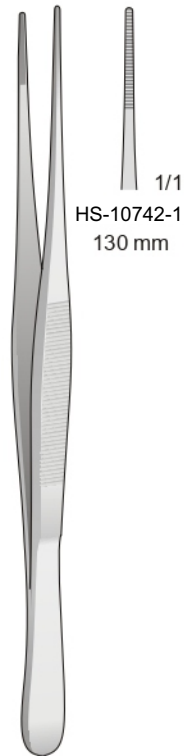

SEMKEN
HS-10742
130 mm

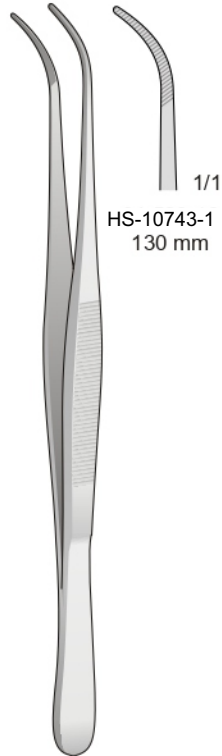

SEMKEN
HS-10743
130 mm

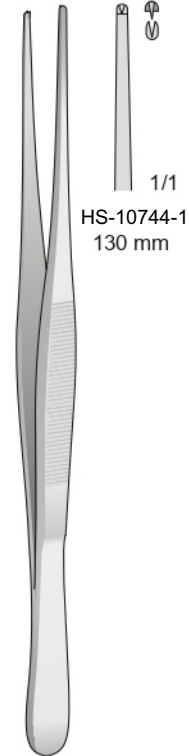

SEMKEN
HS-10744
130 mm

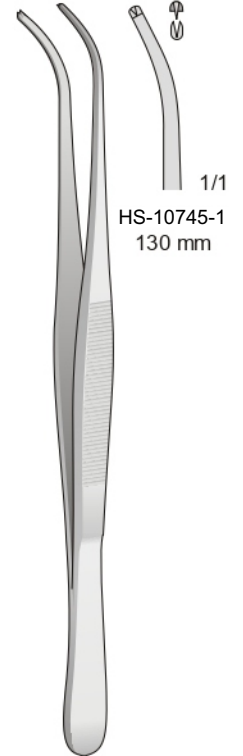

SEMKEN
HS-10745
130 mm

Tissue Forceps

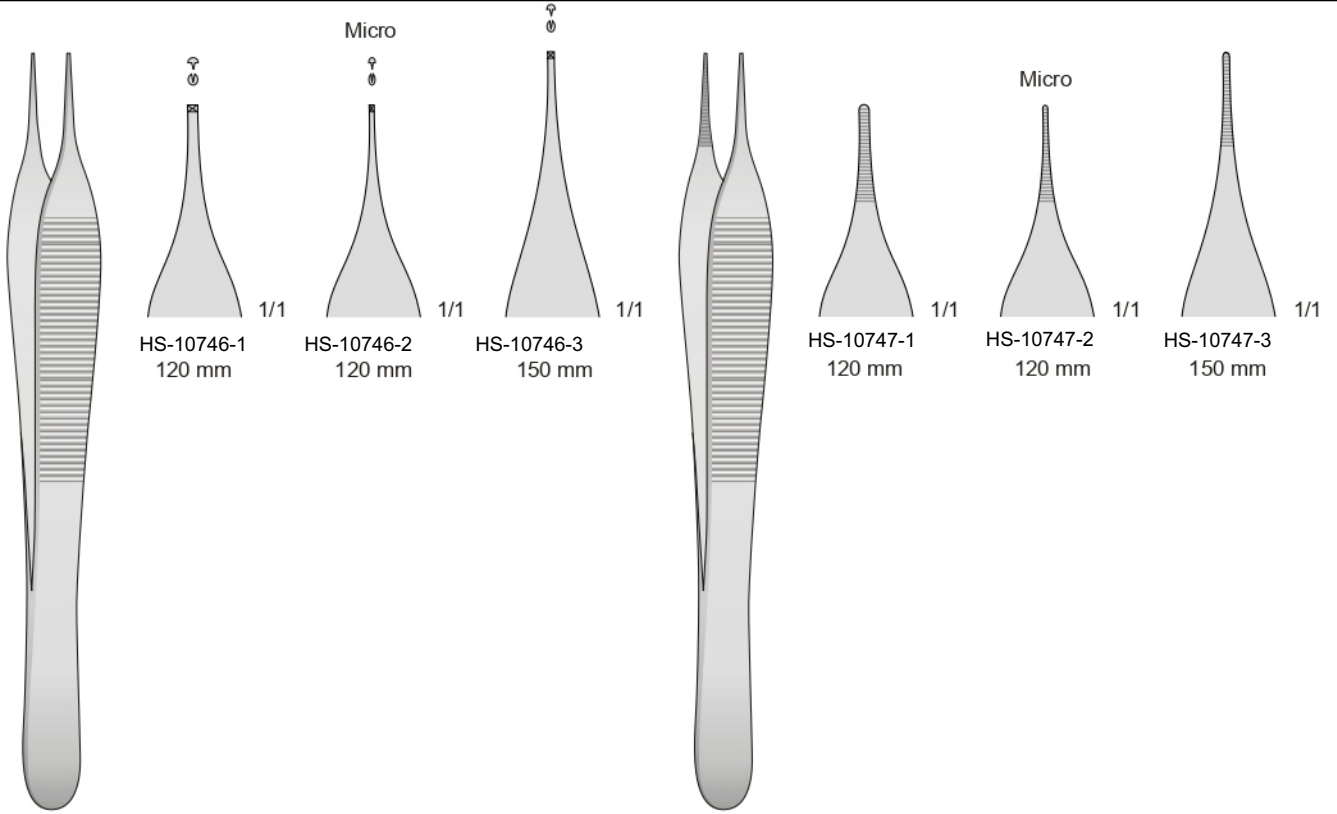

ADSON
HS-10746

ADSON
HS-10747

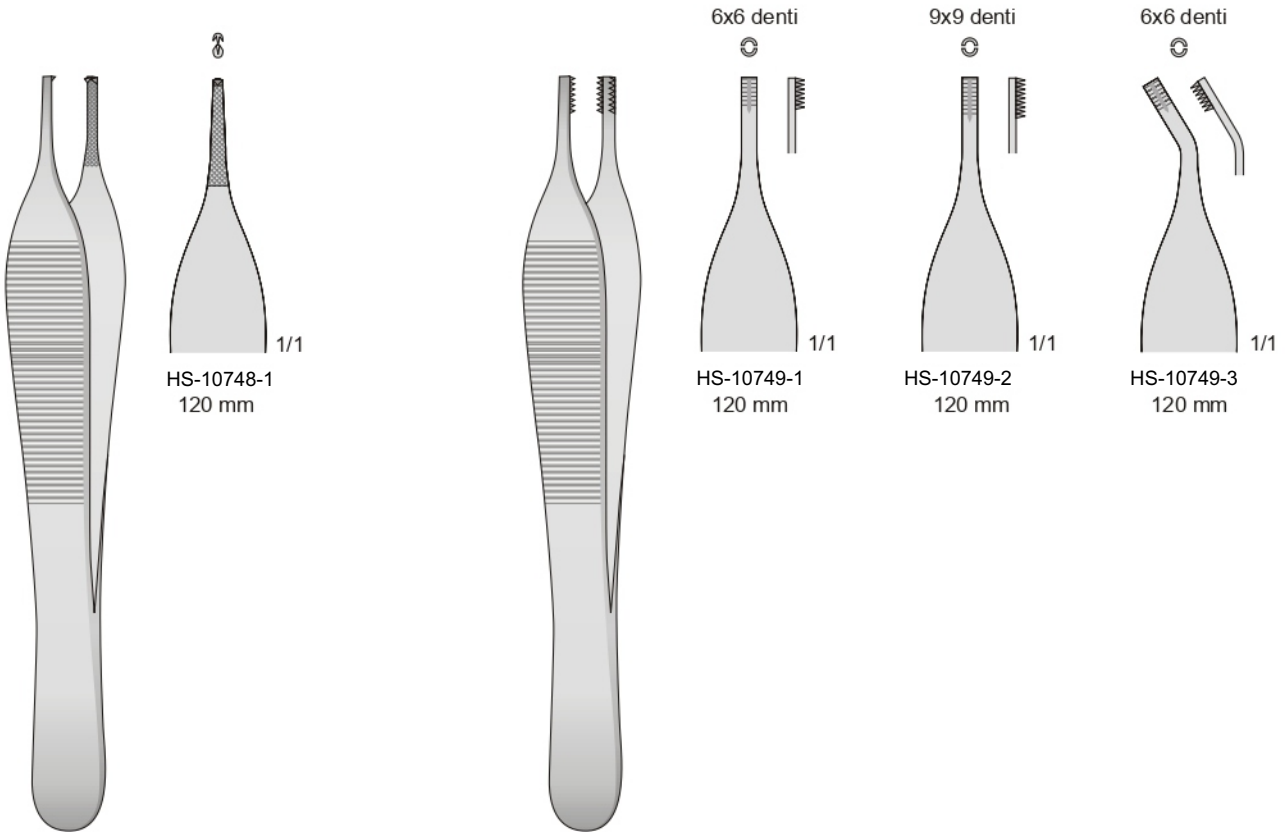

ADSON
HS-10748
120 mm

ADSON-BROWN
HS-10749
120 mm

Dressing Forceps

Standard

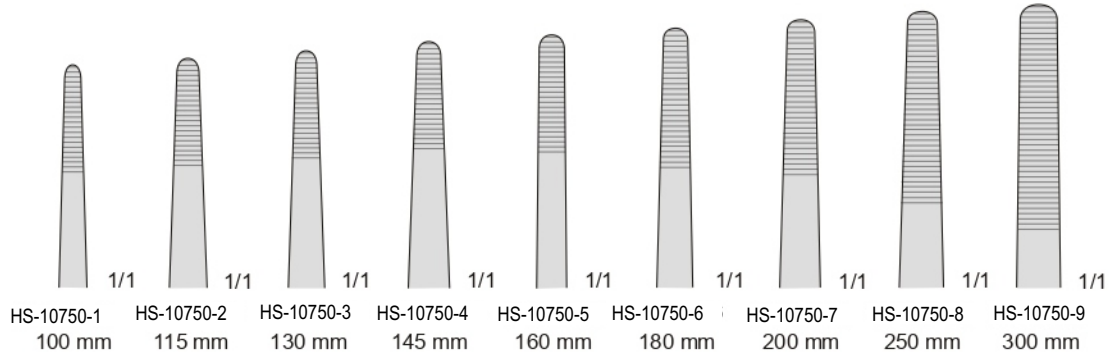

HS-10750

Mod. Fine



HS-10751



STILLE
04-610

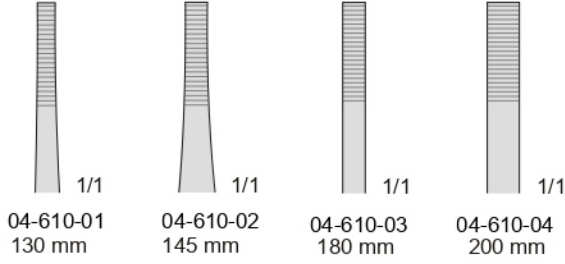

04-620
160 mm

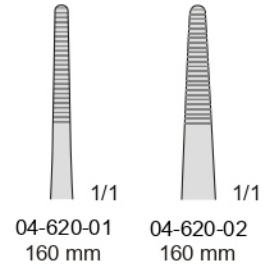

04-630/640

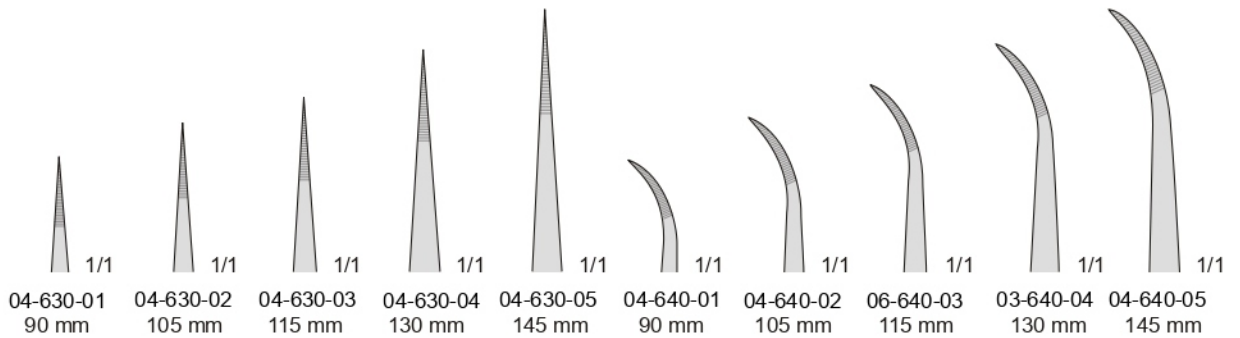

1 x 2 Denti - 1 x 2 Teeth - 1 x 2 Zähne - 1 x 2 Dents - 1 x 2 Dientes



Standard

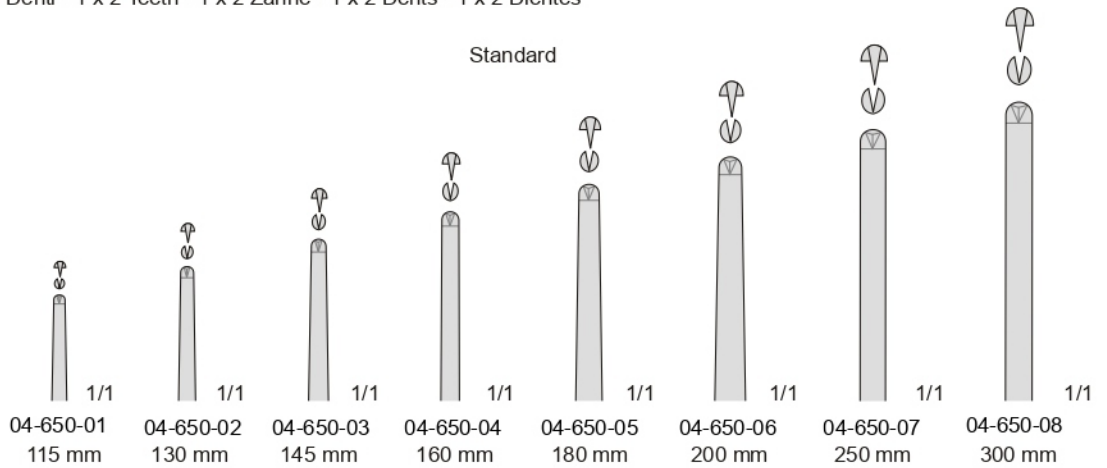

04-650

1 x 2 Denti - 1 x 2 Teeth - 1 x 2 Zähne - 1 x 2 Dents - 1 x 2 Dientes



Strette - Schmal - Narrow - Étroites - Estrechas

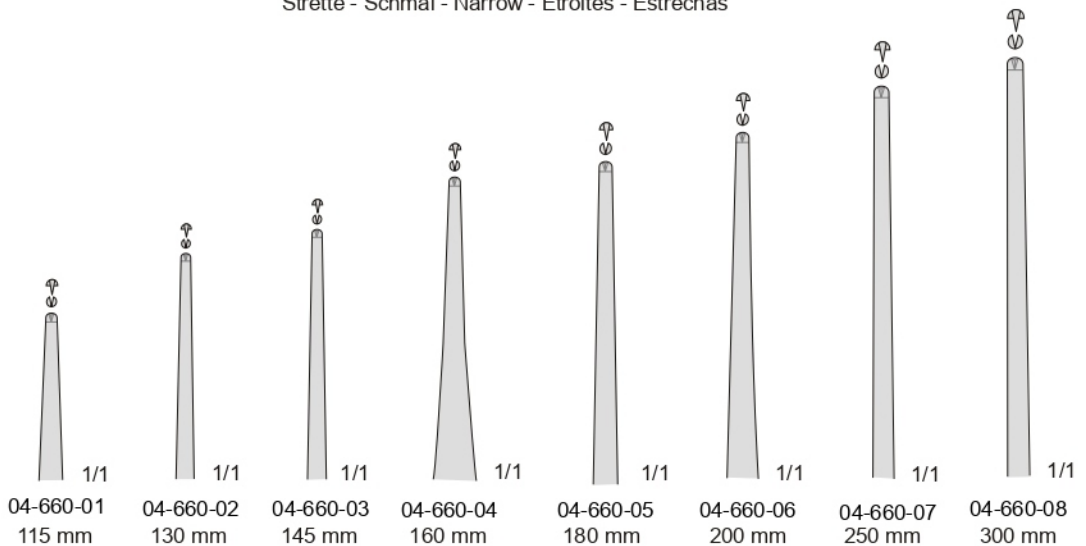

04-660

Strette - Schmal - Narrow - Étroites - Estrechas

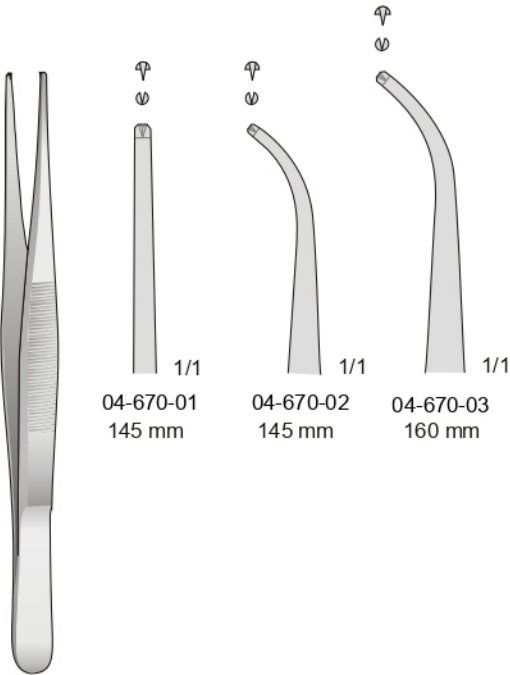

04-670-01
145 mm

04-670-02
145 mm

04-670-03
160 mm

Fine - Delicate - Fein - Fines - Finas

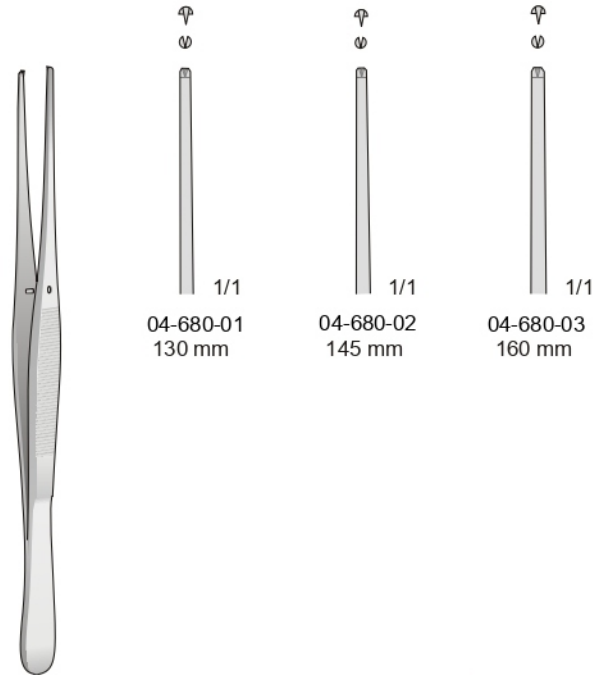

04-680-01
130 mm

04-680-02
145 mm

04-680-03
160 mm

04-670

- 1 x 2 Denti
- 1 x 2 Teeth
- 1 x 2 Zähne
- 1 x 2 Dents
- 1 x 2 Dientes



04-690-01
180 mm
04-690-02
210 mm

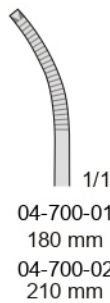

04-700-01
180 mm
04-700-02
210 mm

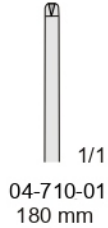

04-710-01
180 mm

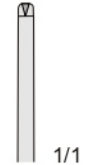

04-710-02
210 mm



04-710-03
250 mm

04-680

- 1 x 2 Denti
- 1 x 2 Teeth
- 1 x 2 Zähne
- 1 x 2 Dents
- 1 x 2 Dientes

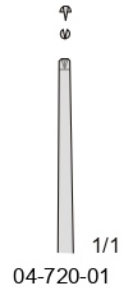

04-720-01
150 mm



04-720-02
150 mm

POTTS-SMITH
04-690

POTTS-SMITH
04-710

SEMKEN
04-720
150 mm

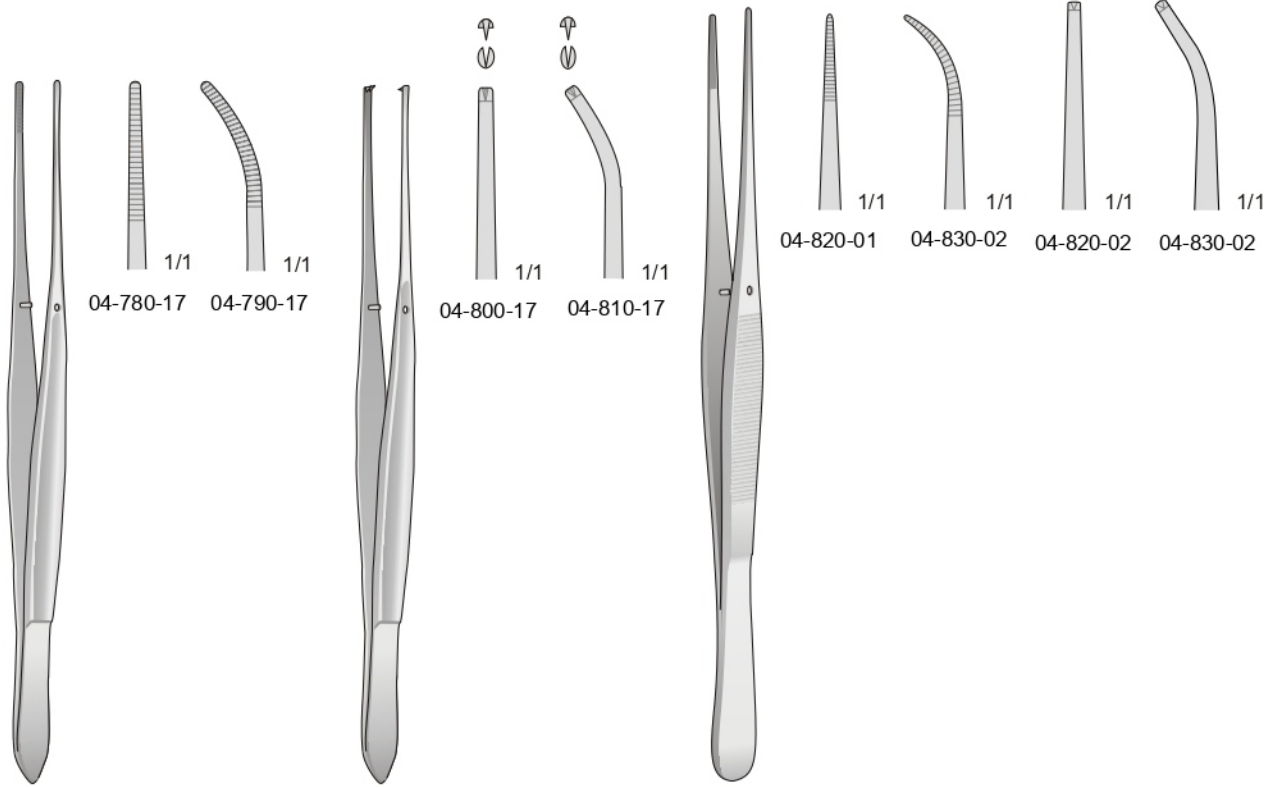

CUSHING
04-780
175 mm

CUSHING
04-800
175 mm

04-820
200 mm

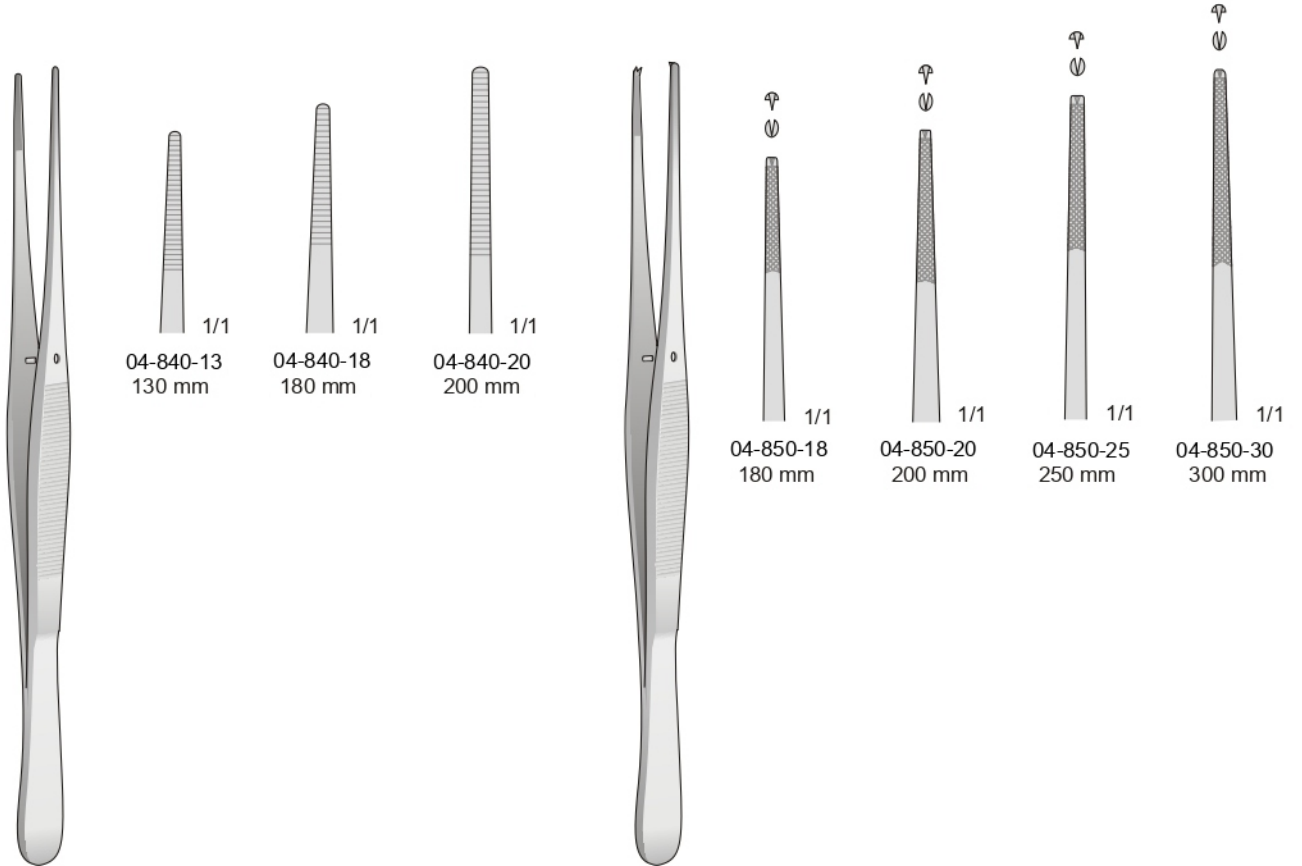





04-840

04-850



2 x 3 Denti - 2 x 3 Teeth - 2 x 3 Zähne
2 x 3 Dents - 2 x 3 Dientes







- 
 04-860-11
115 mm
- 
 04-860-14
145 mm
- 
 04-860-16
160 mm
- 
 04-860-18
180 mm
- 
 04-860-20
200 mm

04-860



3 x 4 Denti - 3 x 4 Teeth - 3 x 4 Zähne
3 x 4 Dents - 3 x 4 Dientes





- 
 04-870-14
145 mm
- 
 04-870-16
160 mm
- 
 04-870-20
200 mm
- 
 04-870-25
250 mm

04-870

4 x 5 Denti
4 x 5 Teeth
4 x 5 Zähne
4 x 5 Dents
4 x 5 Dientes



- 
 04-880-14
145 mm
- 
 04-880-16
160 mm

04-880



1/1

GERALD
04-890-18
180 mm

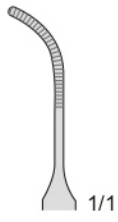

1/1

GERALD
04-900-18
180 mm



1/1

GERALD
04-910-18
180 mm

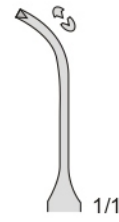

1/1

GERALD
04-920-18
180 mm



1/1

GERALD-BROWN
04-930-18
180 mm

Pinzette per vasi e per tumori
Pincers vasculaires et pour tumeurs

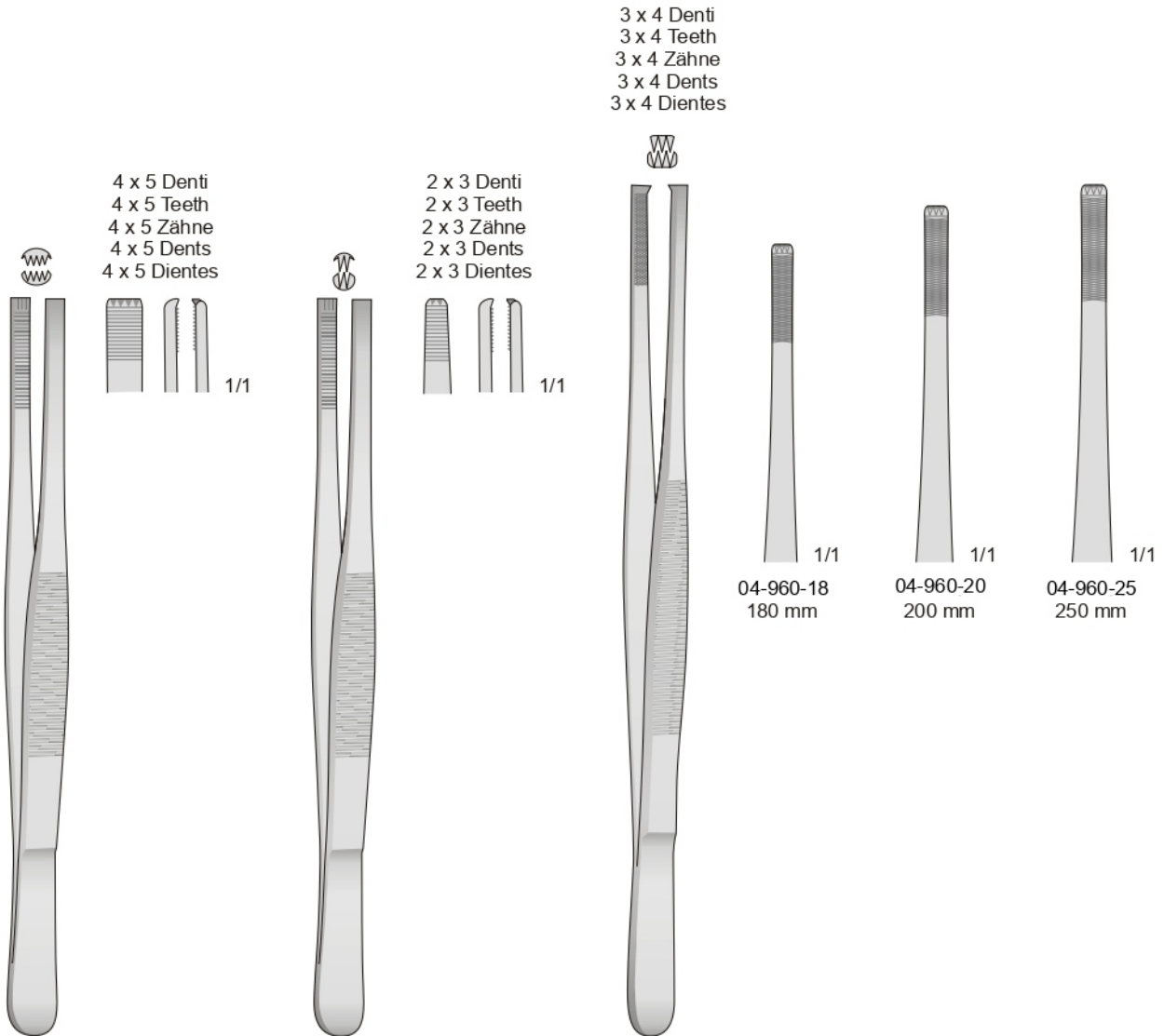

ADLERKREUTZ
04-940-15 - 150 mm
04-940-20 - 200 mm
04-940-25 - 250 mm

ADLERKREUTZ
04-950-15 - 150 mm
04-950-20 - 200 mm

STILLE-BARRAYA
04-960

04-960-18
180 mm

04-960-20
200 mm

04-960-25
250 mm



Dressing Forceps



DURANTE
04-970

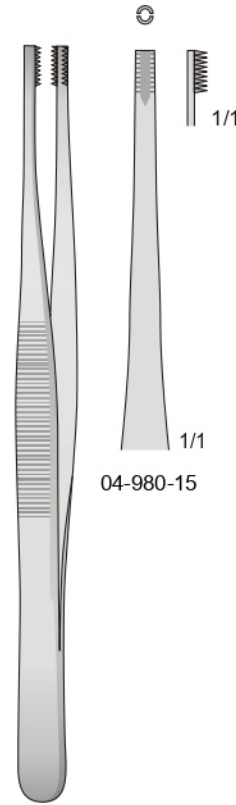
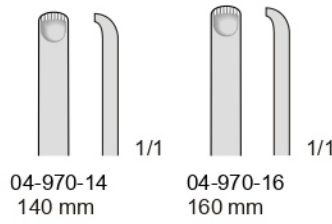

BROWN
04-980
150 mm

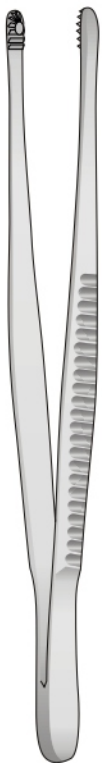

RUSSIAN
04-990

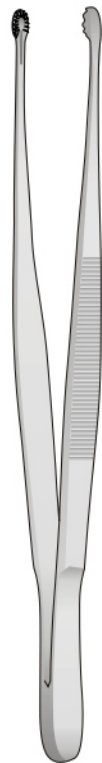
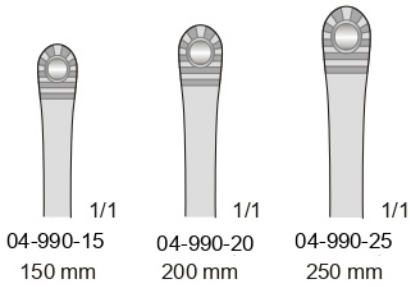

SELMAN
04-1000-15
150 mm



SINGLEY-TUTTLE
04-1010-23
230 mm



MAYO-RUSSIAN
04-1020-23
230 mm

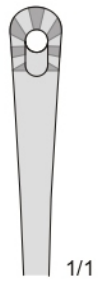

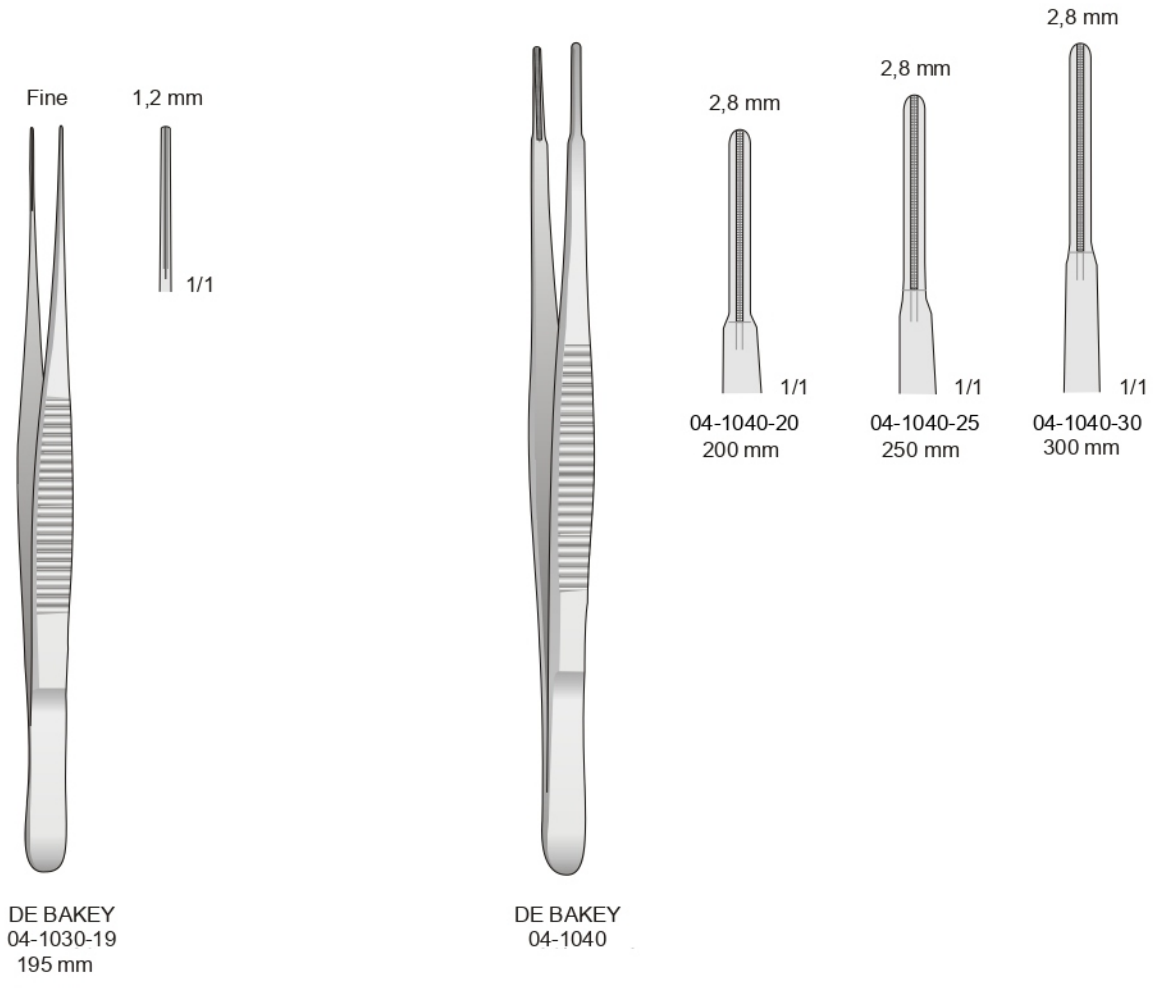

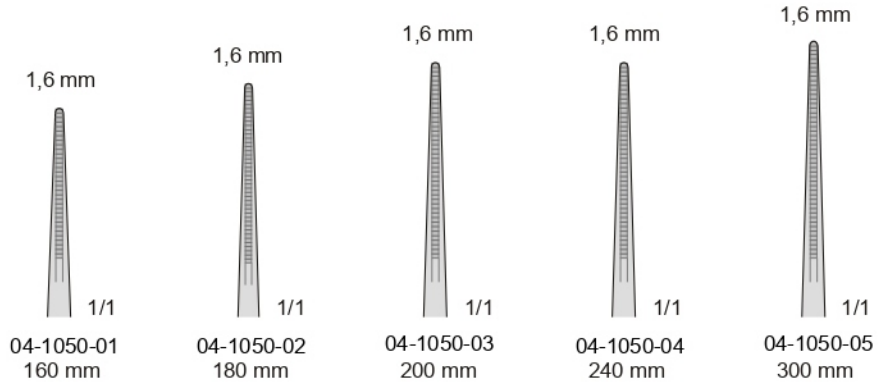

Pinzette atraumatiche
Non-traumatic vascular tissue forceps
Atraumatische pinzetten
Pincés atraumáticas
Pinzas atraumaticas



DE BAKEY
04-1050/1060

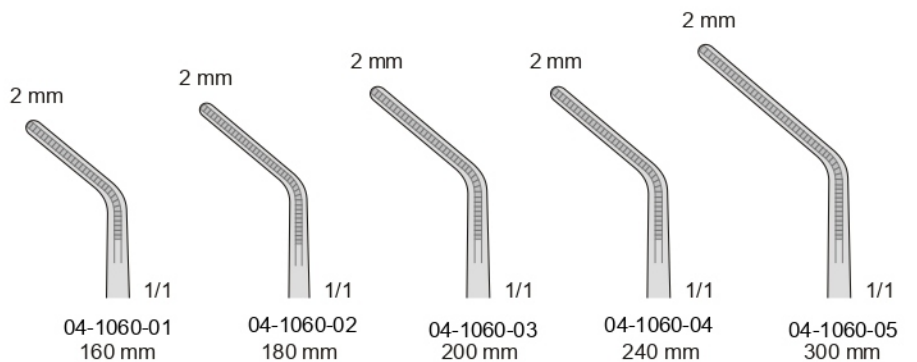
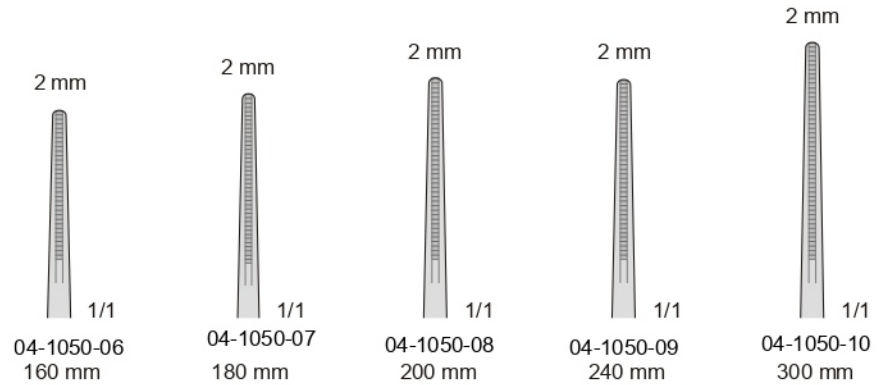

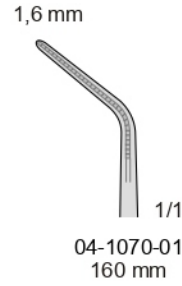

Pinzette atraumatiche
Atraumatische pinzetten
Atraumatic vascular tissue forceps
Pincés atraumáticas
Pinzas atraumáticas



DE BAKEY
04-1070/1080

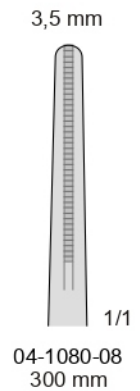
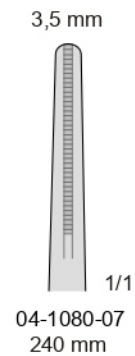
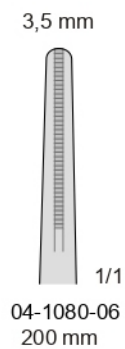
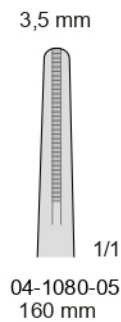
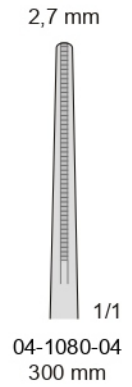
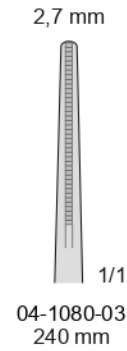
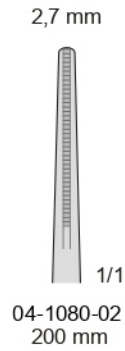
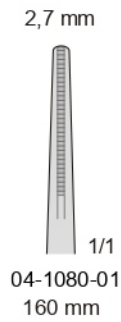



Pinze da Fissazione-oftalmica - Fixier und fasspinzetten
Fixation and Grasping forceps - Pinzas de fijación y de aprehensión

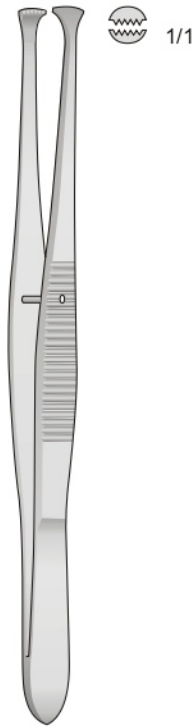

GRAEFE
04-1090-11
110 mm

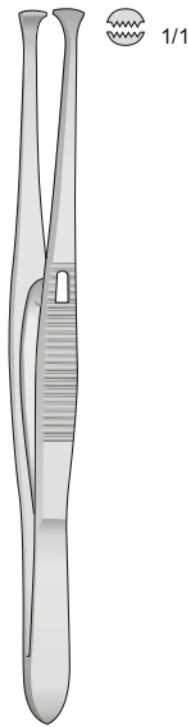

GRAEFE
04-1100-11
110 mm

Pinzetta-Columella
con stop



COTTLE
04-1110-10
100 mm

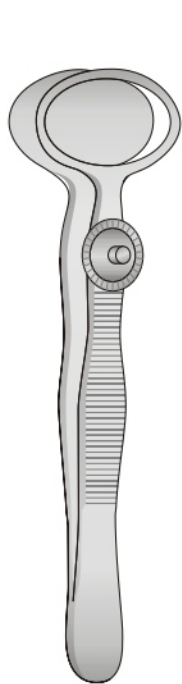
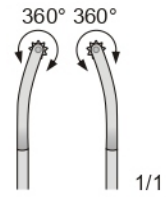

DESMARRES
04-1120
90 mm

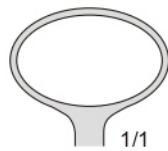

04-1120-20
20 mm

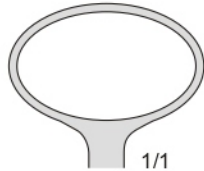

04-1020-26
26 mm

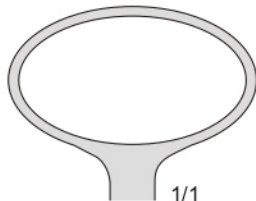

04-1120-31
31 mm



DUVAL
04-1130

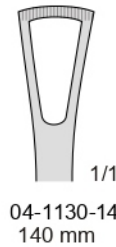

04-1130-14
140 mm

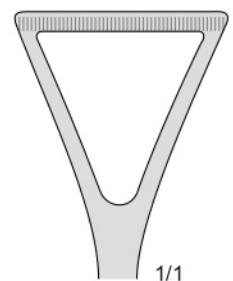

04-1130-20
200 mm

Pinze intestinali
Intestinal forceps
Darmpinzetten
Pincés pour préhension de l'intestin
Pinzas intestinales



Tissue Forceps

Con punta al carburo di tungsteno - Tungsten-carbide forceps
Mit hartmetalleinsätzen - Avec plaquettes en carbure de tungstène - Pinzas con tungsteno



ADSON
04-1140

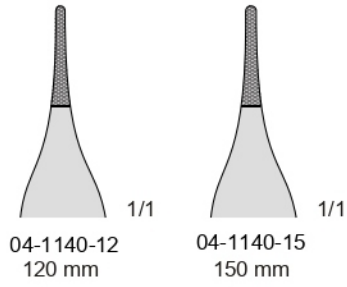

ADSON
04-1150

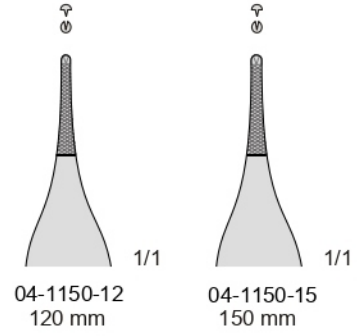

04-1160

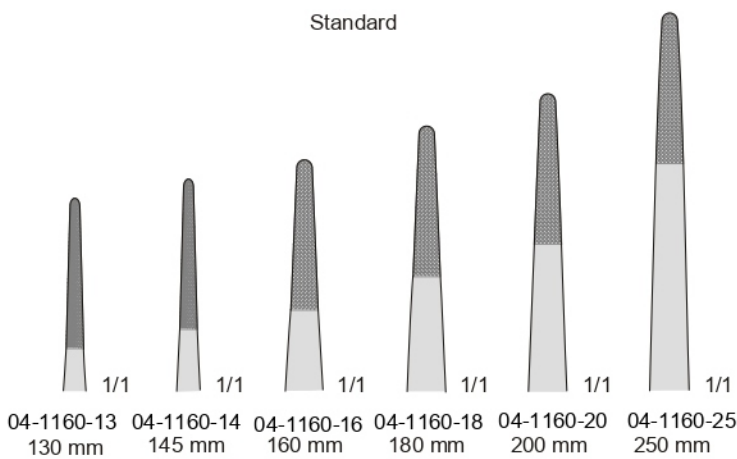

SEMKEN
04-1170

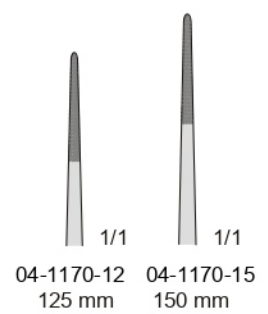

TC

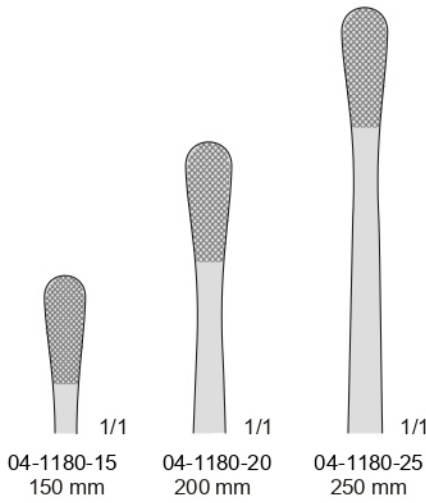

WANGENSTEEN
 04-1180

TC

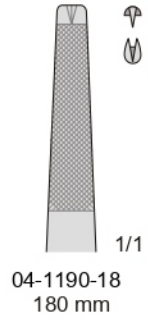

BONNEY
 04-1190
 180 mm

TC

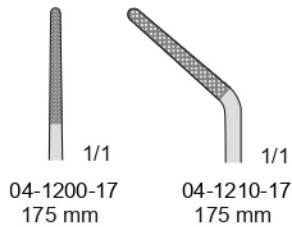

Con dissettore
 With Dissector End
 Mit Dissektor-Ende
 Avec bout disecteur
 Con cabo disecador

CUSHING
 04-1200
 175 mm

TC

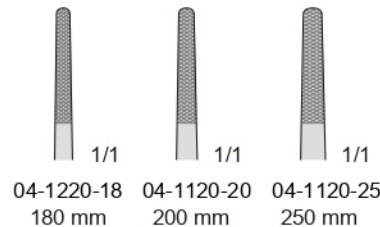

Con dissettore
 With Dissector End
 Mit Dissektor-Ende
 Avec bout disecteur
 Con cabo disecador

POTTS-SMITH
 04-1220

TC

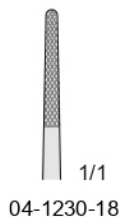

Con dissettore
 With Dissector End
 Mit Dissektor-Ende
 Avec bout disecteur
 Con cabo disecador

TAYLOR
 04-1230
 185 mm



Con punta al carburo di tungsteno
Tungsten-carbide forceps
Mit hartmetalleinsätzen
Avec plaquettes en carbure de tungstène
Pinzas con tungsteno

TC



DE BAKEY
04-1240-18
180 mm

TC



04-1250

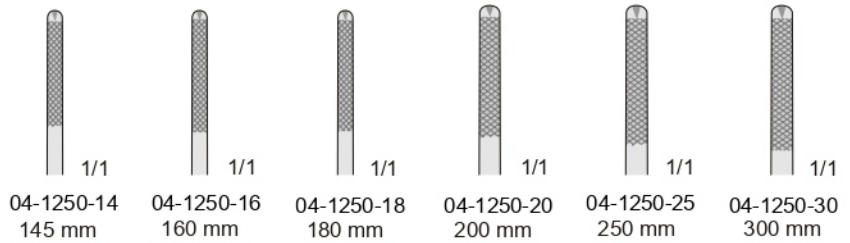

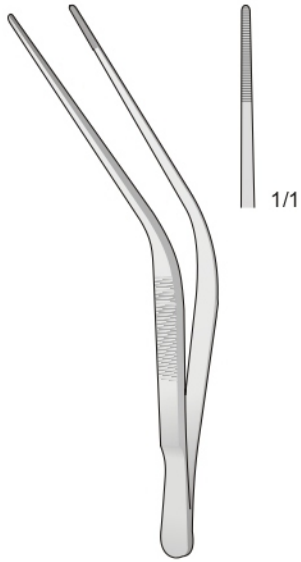

TROELTSCH
04-1260-11
110 mm

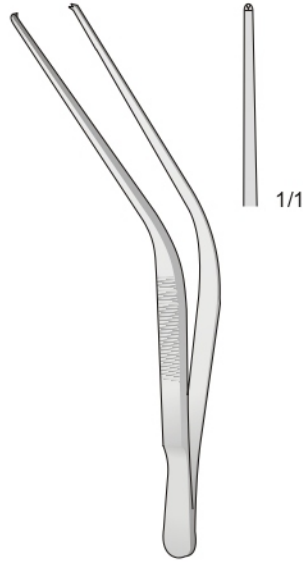

TROELTSCH
04-1270-11
110 mm

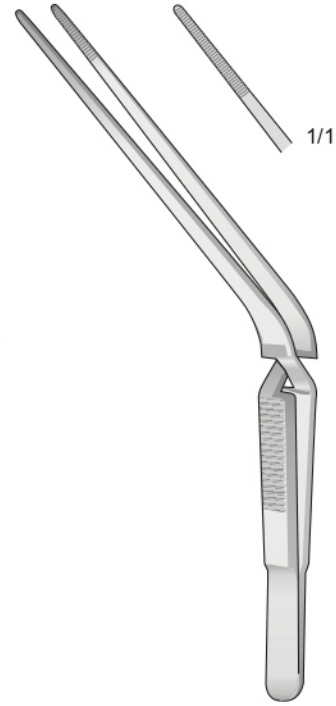

TROELTSCH
04-1280-13
130 mm

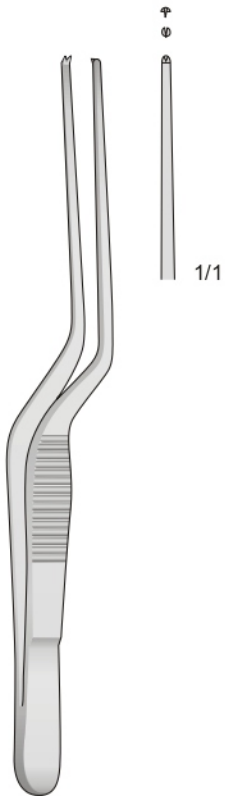

LUCAE
04-1290-14
140 mm

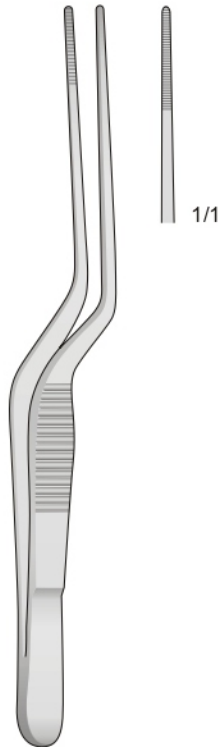

LUCAE
04-1300-14
140 mm

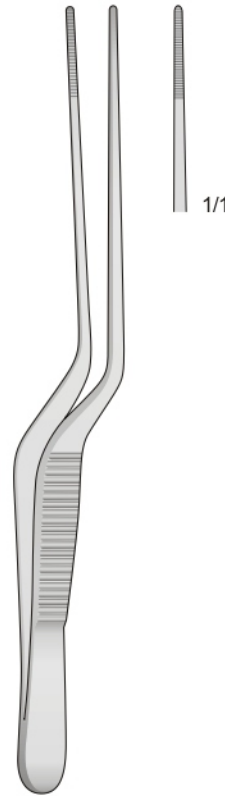

JANSEN
04-1310-16
160 mm

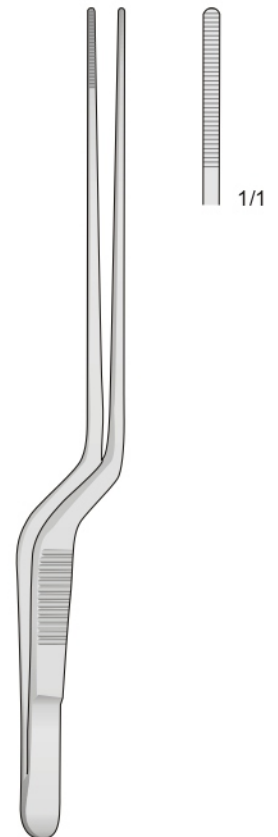

GRÜNWALD
04-1320-20
200 mm

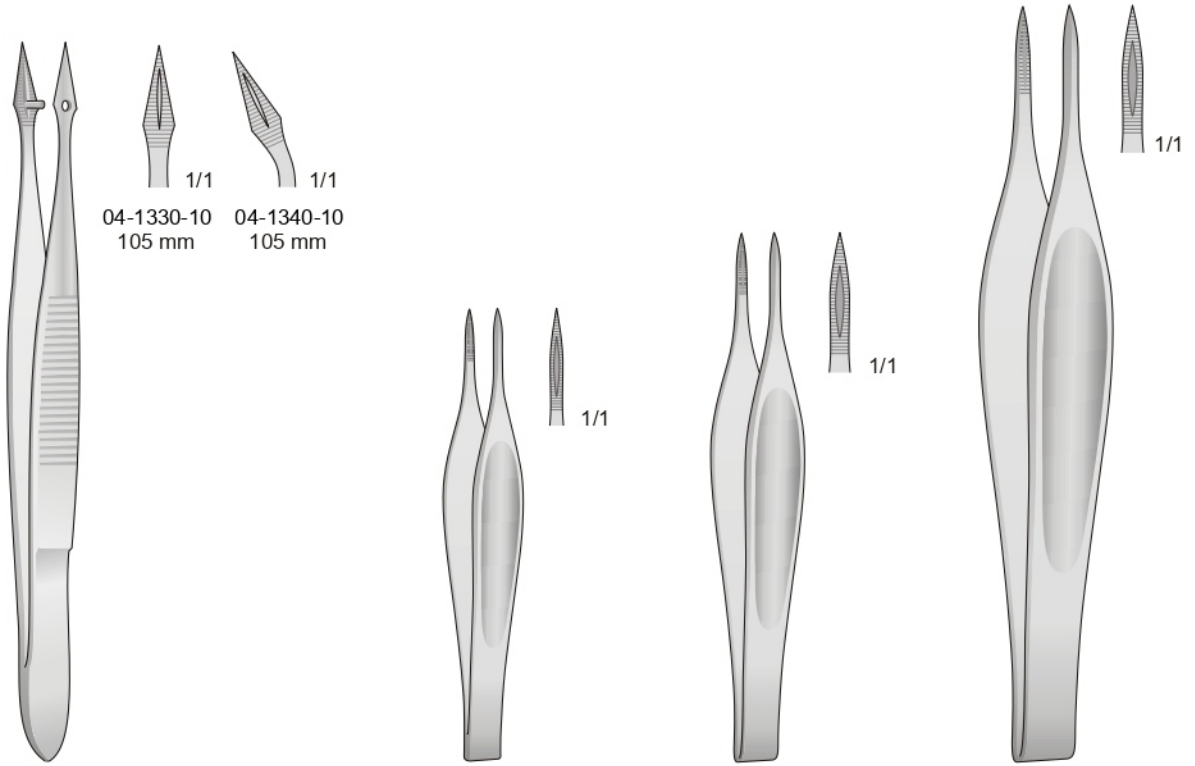

HUNTER
04-1330

FEICHENFELD
04-1350-07
75 mm

FEICHENFELD
04-1350-09
90 mm

FEICHENFELD
04-1350-11
115 mm

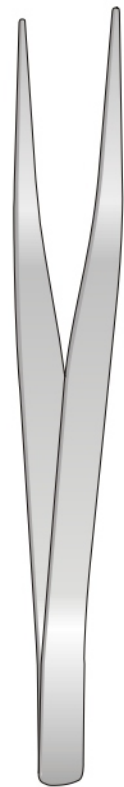

04-1360-15
150 mm

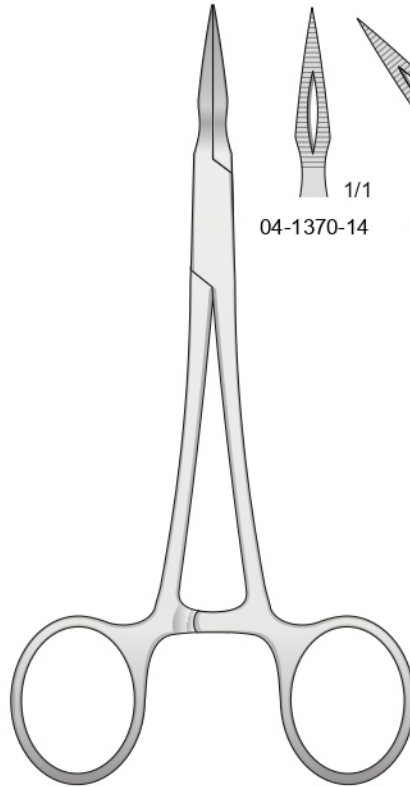

STIEGLITZ
04-1370
140 mm

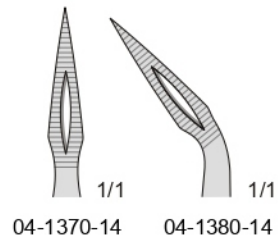

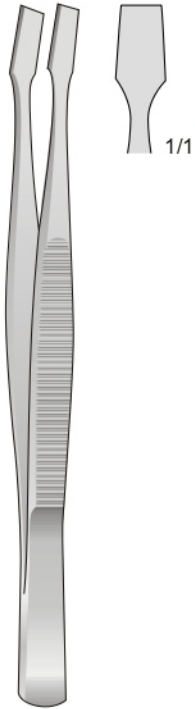

KÜHNE
04-1390-10
105 mm

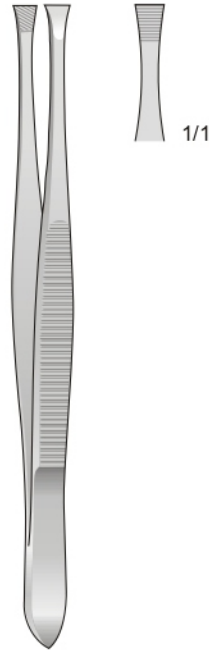

LITTAUER
04-1400-08
85 mm

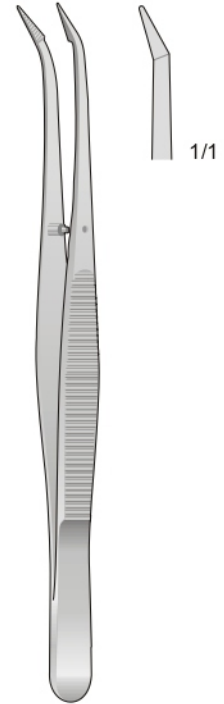

BARRAQUER
04-1410-10
105 mm

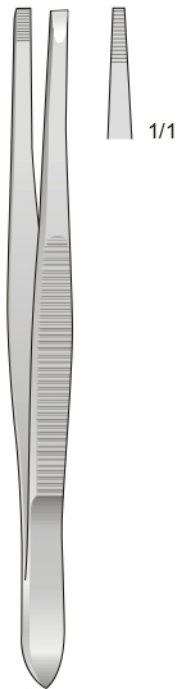

04-1420-09
90 mm

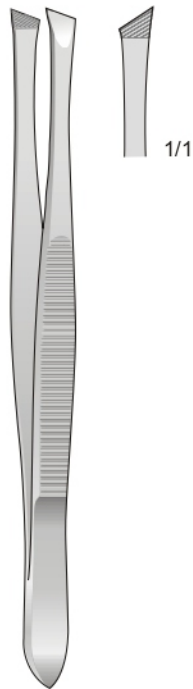

04-1430-09
90 mm

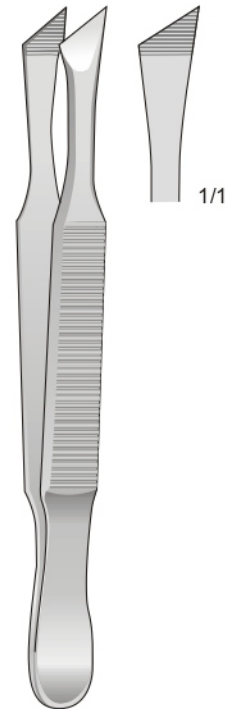

BERGH
04-1440-10
105 mm

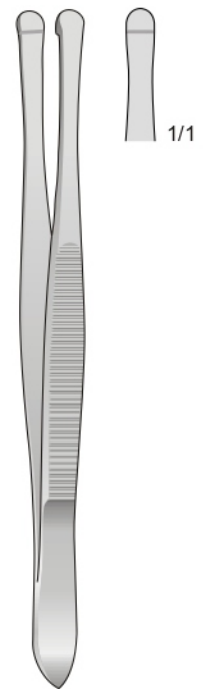

BEER
04-1450-09
90 mm

**Manufacturer & Exporter
Of Surgical, Dental & Beauty Instruments.**



Health Fast Surgical

Surgical Manufacturer Company

+92 (342) 880 9017

+92 (342) 880 9017

info@healthfastsurgical.com

www.healthfastsurgical.com

Dogra Khurd, P.O Harrar Sialkot-51310 Pakistan.



ISO
9001:2008

