

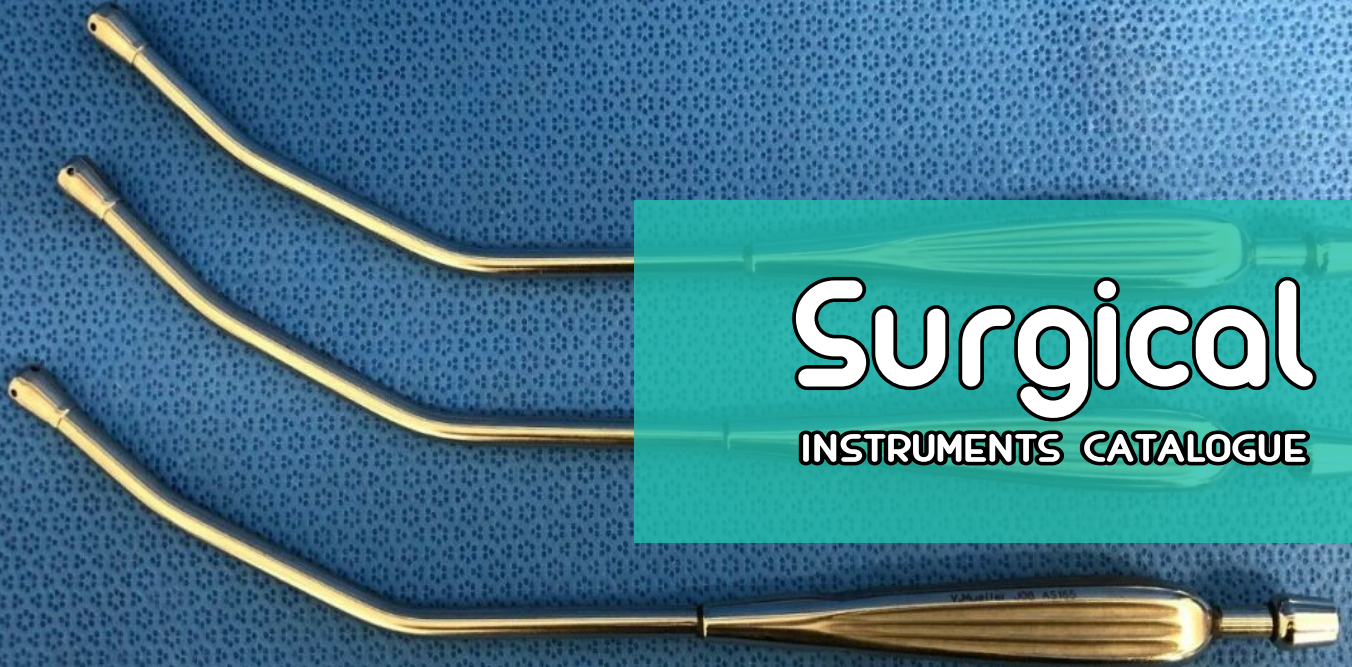

**Health Fast Surgical**  
Surgical Manufacturer Company



**Surgical**  
INSTRUMENTS CATALOGUE

***Suction Tube***

[www.healthfastsurgical.com](http://www.healthfastsurgical.com)

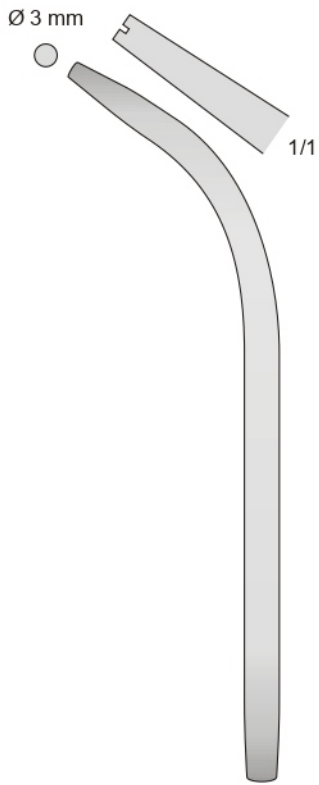

HS-9901-1  
140 mm

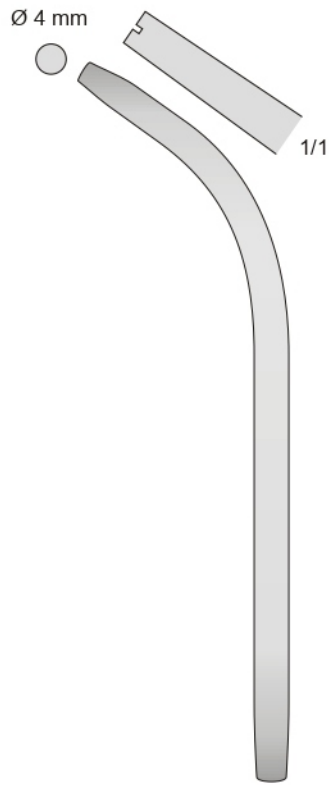

HS-9901-2  
140 mm

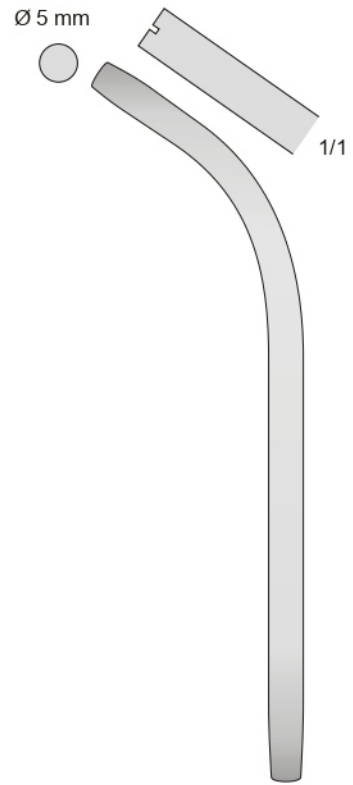

HS-9901-3  
140 mm

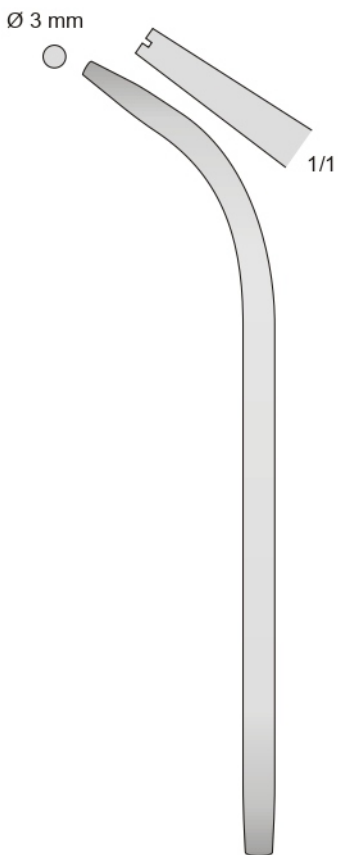

HS-9902-1  
170 mm

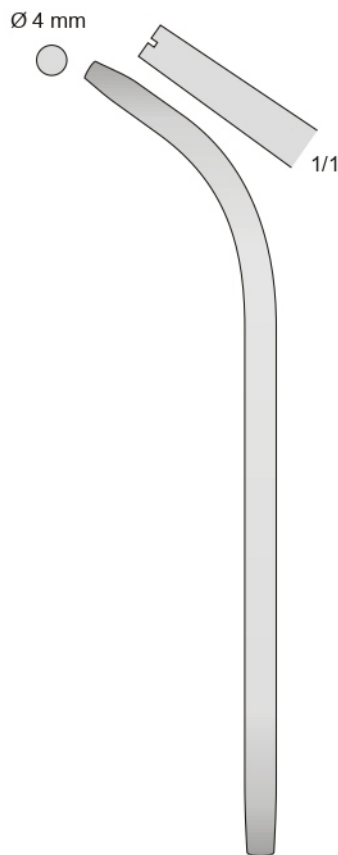

HS-9902-2  
170 mm

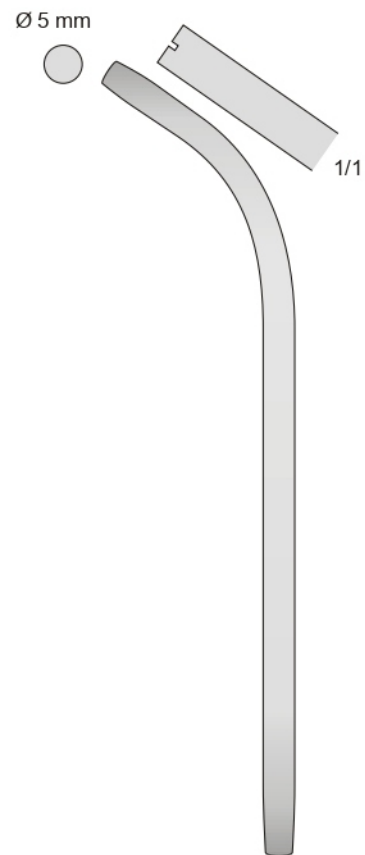

HS-9902-3  
170 mm



Ø 2 mm int.

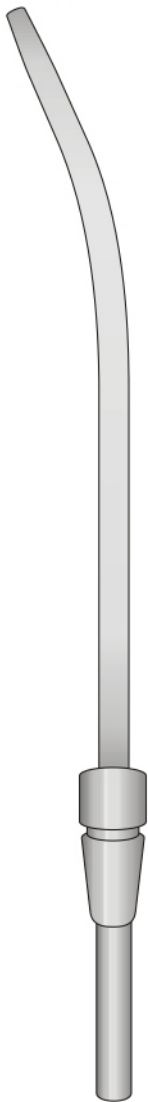

Mc KESSON  
HS-9903-1  
180 mm

Ø 3 mm int.

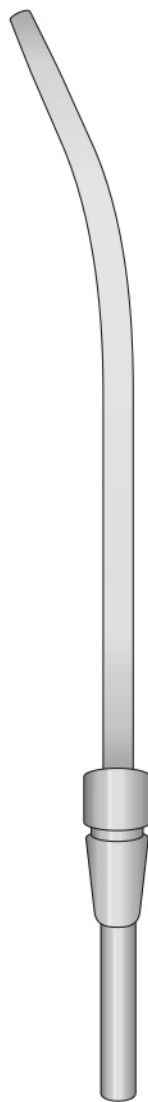

Mc KESSON  
HS-9903-2  
180 mm

Ø 4 mm int.

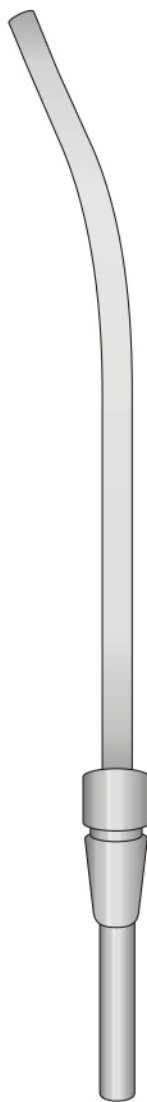

Mc KESSON  
HS-9903-3  
180 mm

Ø 4 mm int.

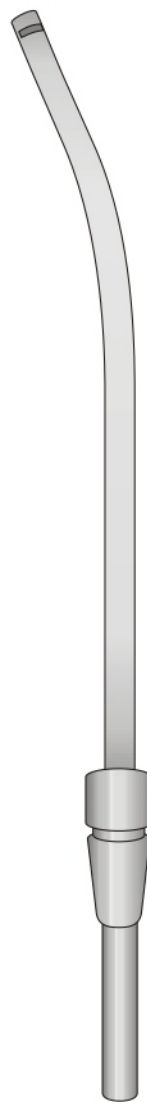

Mc KESSON  
HS-9903-4  
180 mm

Ø 3 mm

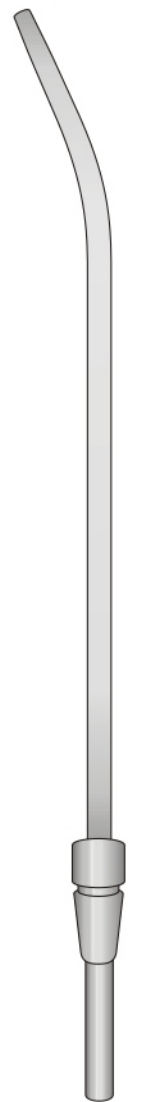

Mc KESSON  
HS-9903-5  
230 mm

Ø 4 mm

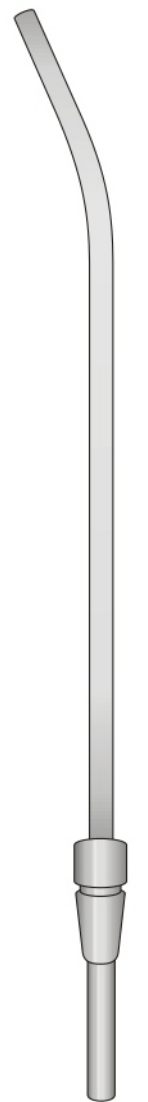

Mc KESSON  
HS-9903-6  
230 mm

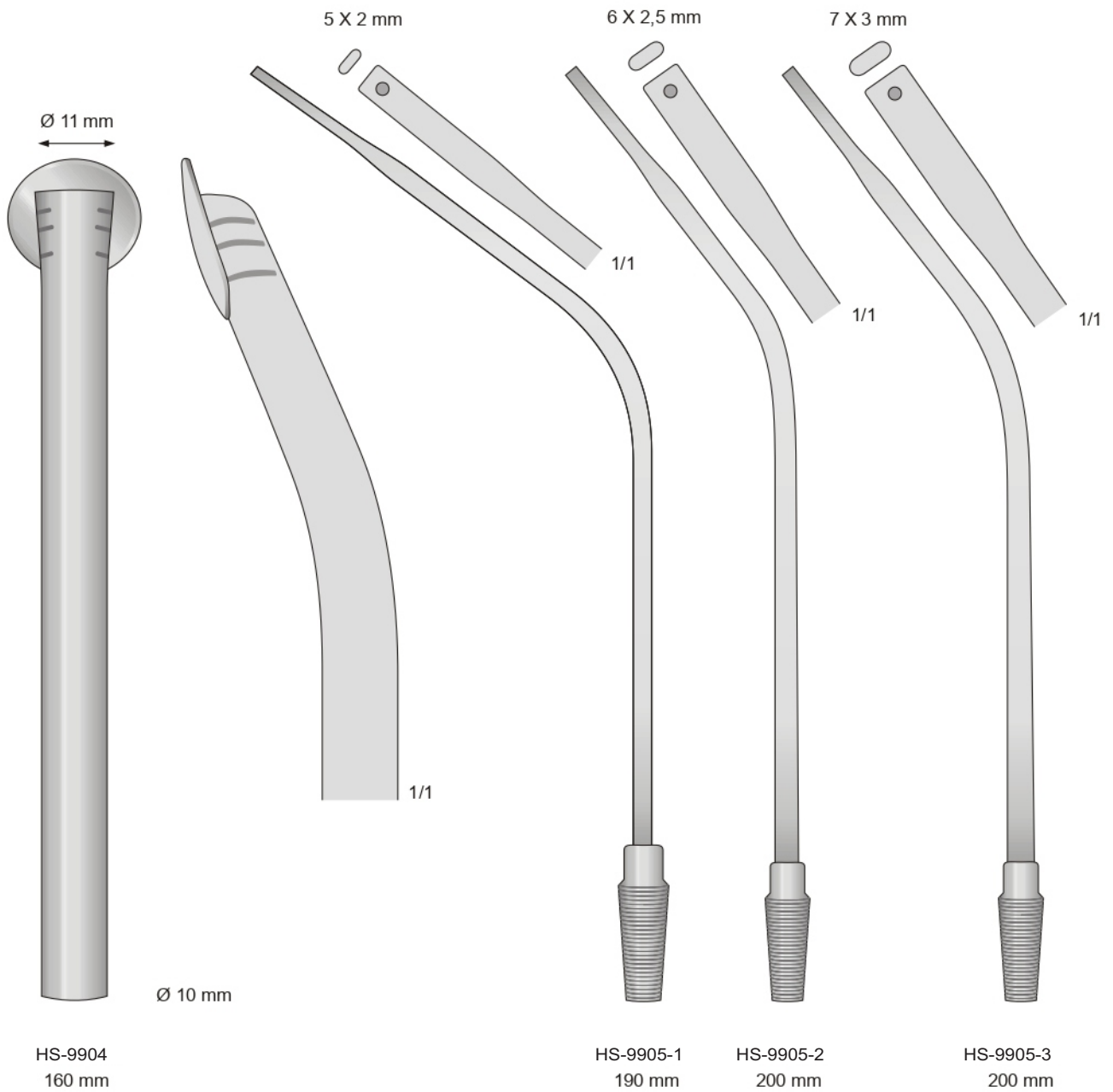

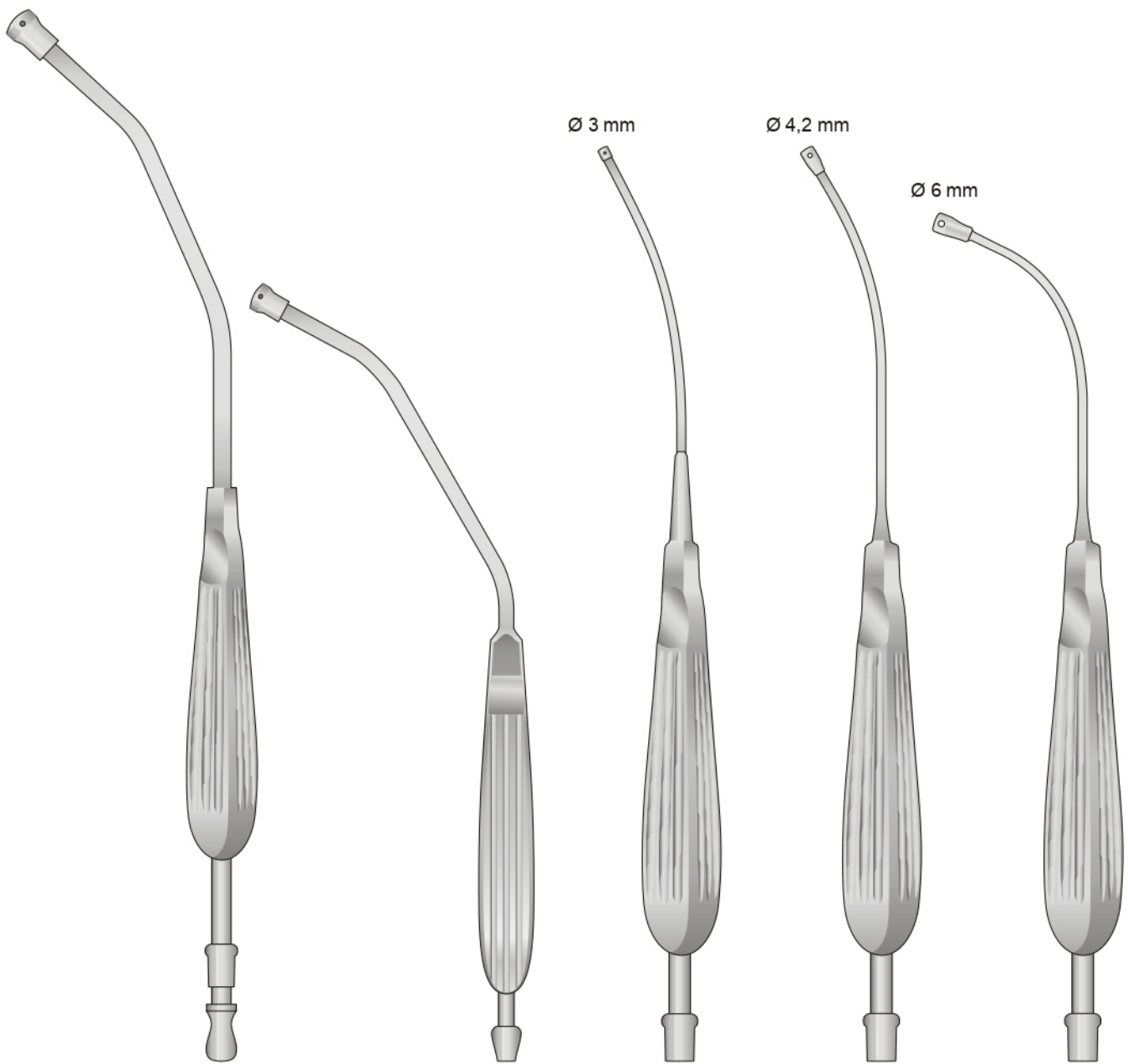

YANKAUER  
 HS-9906  
 310 mm

BABY-YANKAUER  
 HS-9907-1  
 200 mm

ANDREWS-PYNCHON  
 HS-9907-2  
 250 mm

ANDREWS-PYNCHON  
 HS-9907-3  
 250 mm

ANDREWS-PYNCHON  
 HS-9907-4  
 230 mm

Manico portacanule  
Set - Satz - Jeu - Jeugo

Completo con 4 canule  
Complet with 4 tubes  
Komplett mit 4 Kanülen  
Complete avec 4 canules  
Completo con 4 cânulas

Manico portacanule  
Set - Satz - Jeu - Jeugo

Completo con 3 canule  
Complet with 3 tubes  
Komplett mit 3 Kanülen  
Complete avec 3 canules  
Completo con 3 cânulas

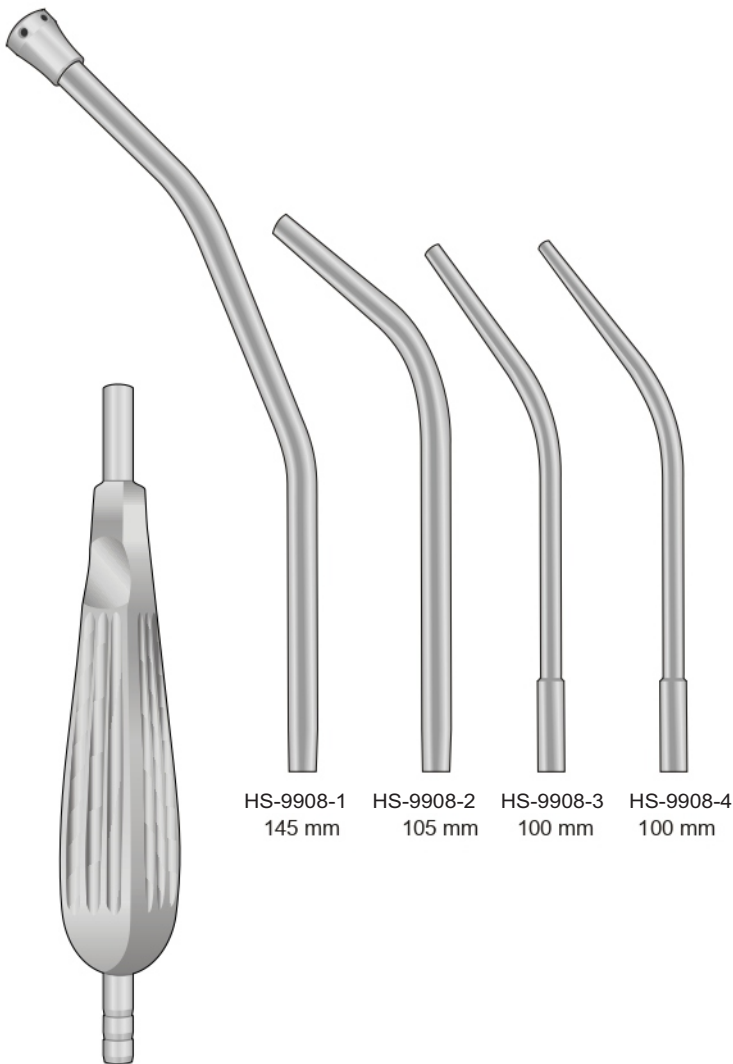

HS-9908-1 145 mm  
HS-9908-2 105 mm  
HS-9908-3 100 mm  
HS-9908-4 100 mm

HS-9908  
150 mm

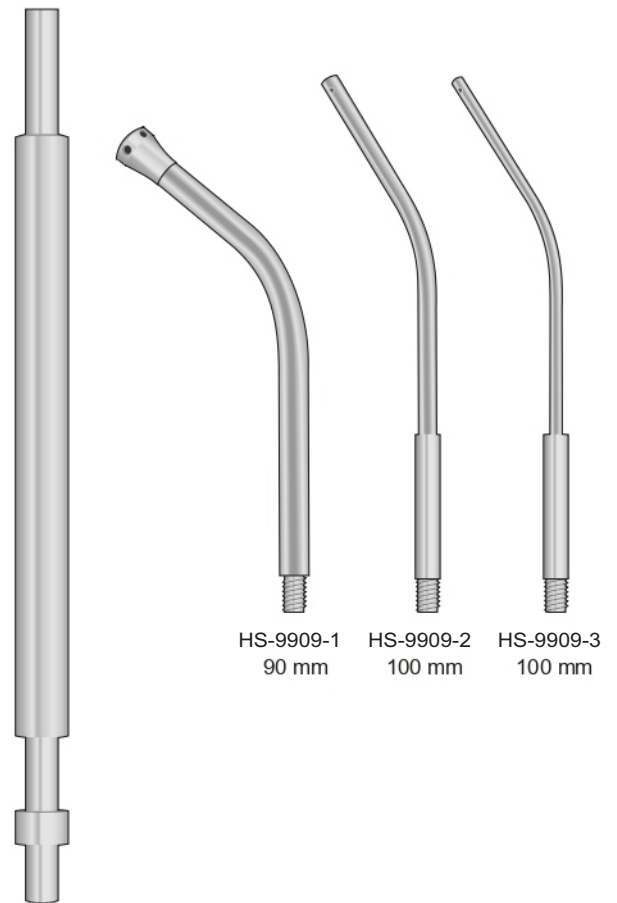

HS-9909-1 90 mm  
HS-9909-2 100 mm  
HS-9909-3 100 mm

HS-9909  
170 mm

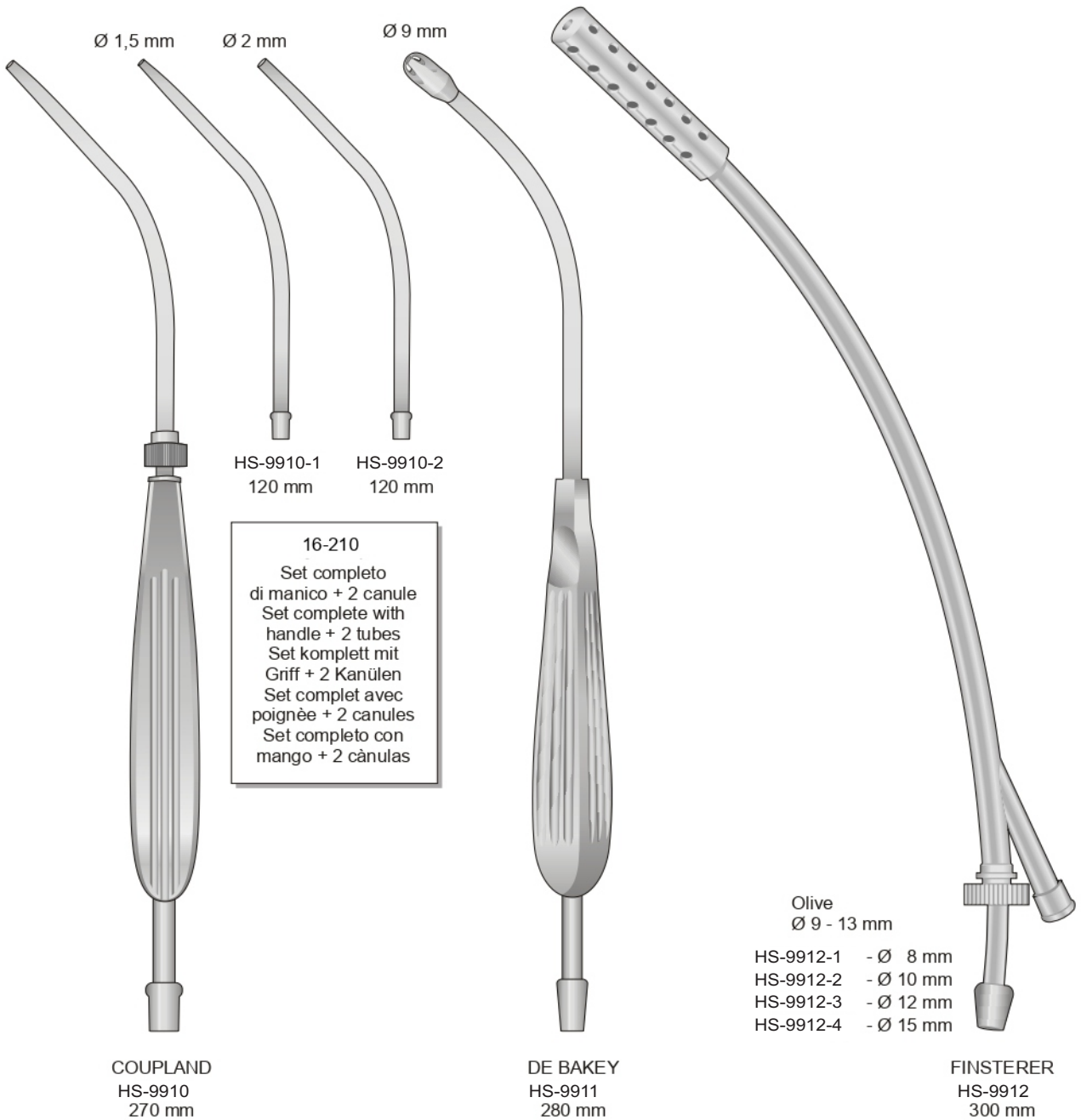

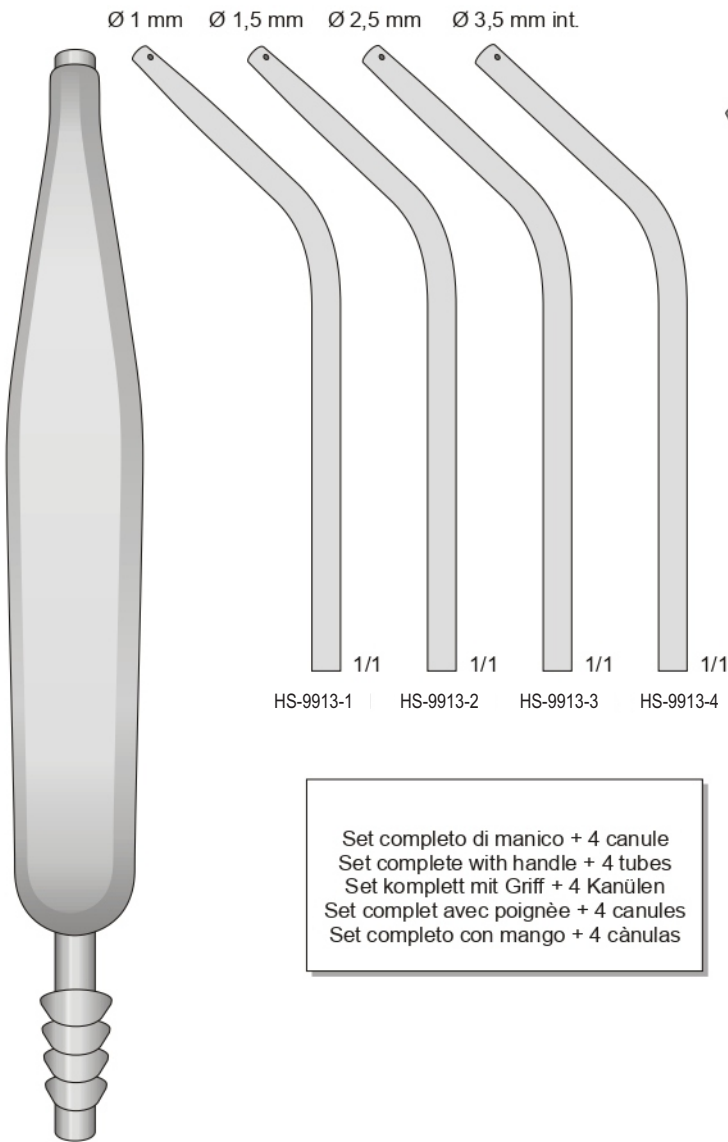

Set completo di manico + 4 canule  
Set complete with handle + 4 tubes  
Set komplett mit Griff + 4 Kanülen  
Set complet avec poignée + 4 canules  
Set completo con mango + 4 cânulas

COUPLAND  
HS-9913  
150 mm

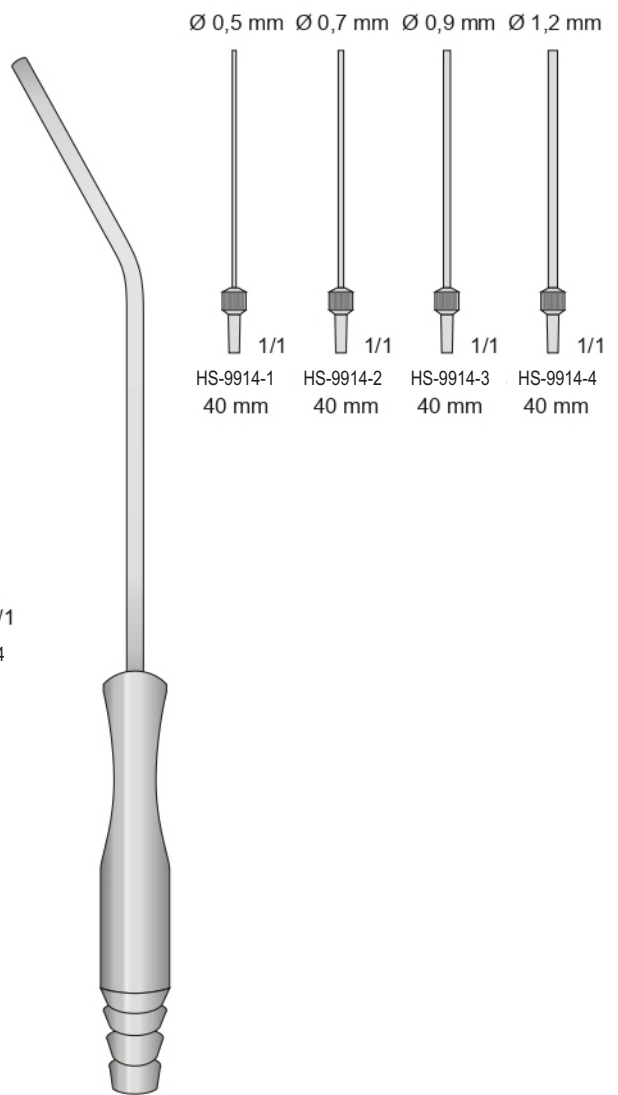

WULLSTEIN  
HS-9914  
140 mm



Acciaio chirurgico - Stainless steel - Rostfrei - Acier - Acero

1/1

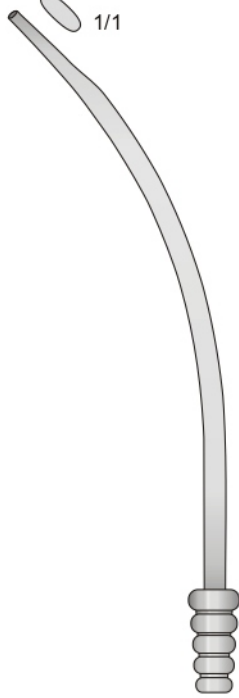

HS-9915  
180 mm

Ø 6 mm

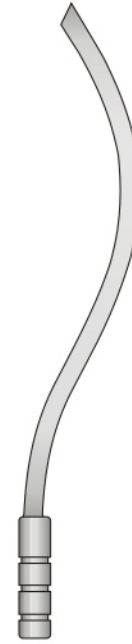

HS-9916  
175 mm

Ø 9 mm

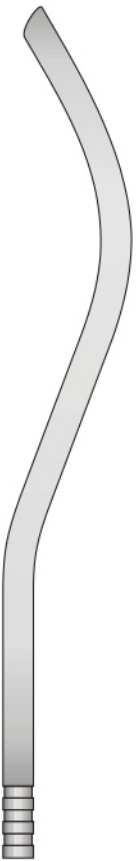

HS-9917  
230 mm

Ø 6 mm

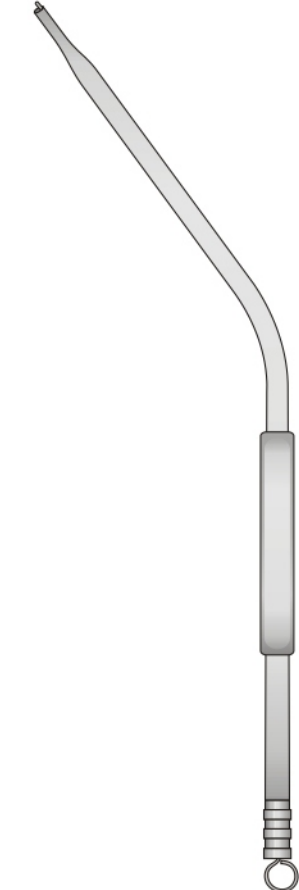

HS-9918  
240 mm

Ø 4 mm

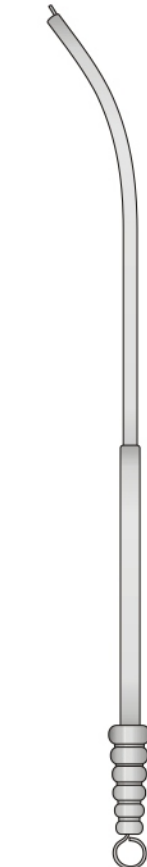

HS-9919  
230 mm

6 mm



Rotondo  
Round  
Rund  
Ronde  
Redonda



NUBOER  
HS-9920  
210 mm

6 mm



Ovale  
Oval  
Ovale  
Ovale  
Ovalada



NUBOER  
HS-9921  
210 mm



Raschiatti



GORNEY  
HS-9922  
180 mm



GORNEY  
HS-9923  
200 mm

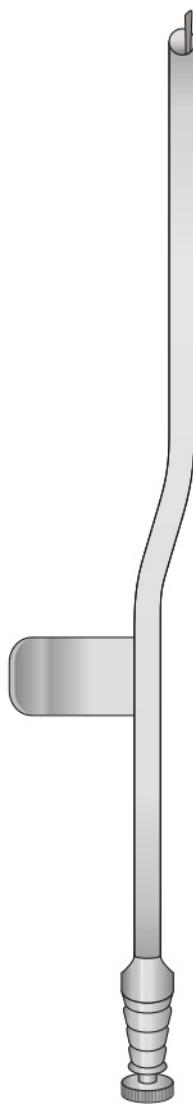

SAUG-RASPATORIUM  
HS-9924-1 Ø 4 mm  
HS-9924-2 Ø 5 mm  
200 mm

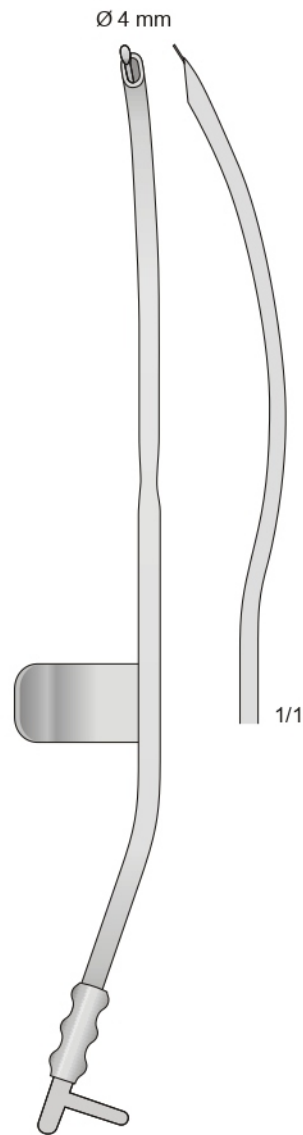

GUILLIEN  
HS-9925  
200 mm

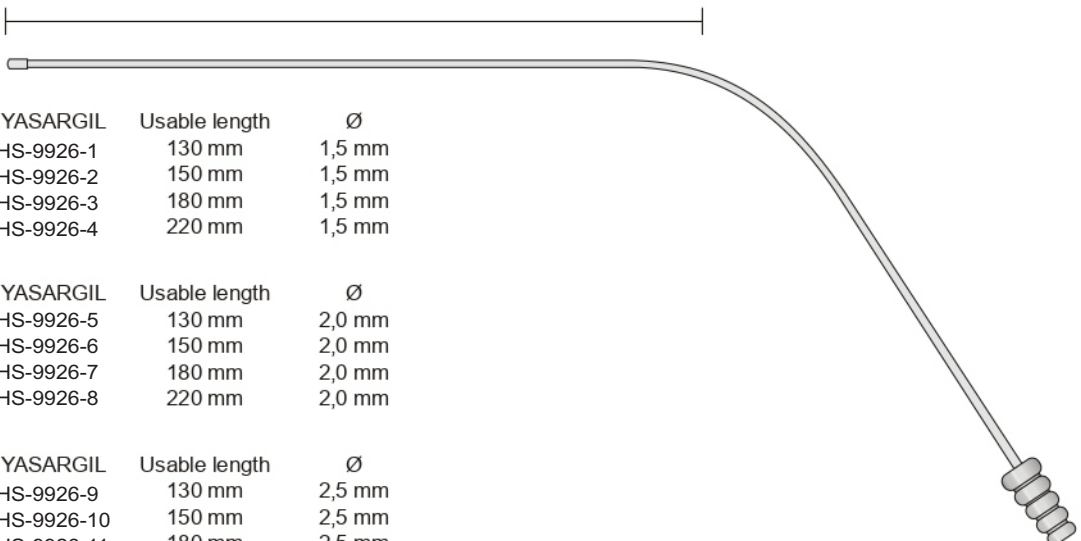

YASARGIL	Usable length	Ø
HS-9926-1	130 mm	1,5 mm
HS-9926-2	150 mm	1,5 mm
HS-9926-3	180 mm	1,5 mm
HS-9926-4	220 mm	1,5 mm
YASARGIL	Usable length	Ø
HS-9926-5	130 mm	2,0 mm
HS-9926-6	150 mm	2,0 mm
HS-9926-7	180 mm	2,0 mm
HS-9926-8	220 mm	2,0 mm
YASARGIL	Usable length	Ø
HS-9926-9	130 mm	2,5 mm
HS-9926-10	150 mm	2,5 mm
HS-9926-11	180 mm	2,5 mm
HS-9926-12	220 mm	2,5 mm
YASARGIL	Usable length	Ø
HS-9926-13	130 mm	3,5 mm
HS-9926-14	150 mm	3,5 mm
HS-9926-15	180 mm	3,5 mm
HS-9926-16	220 mm	3,5 mm
YASARGIL	Usable length	Ø
HS-9926-17	180 mm	4,5 mm

YASARGIL  
HS-9926

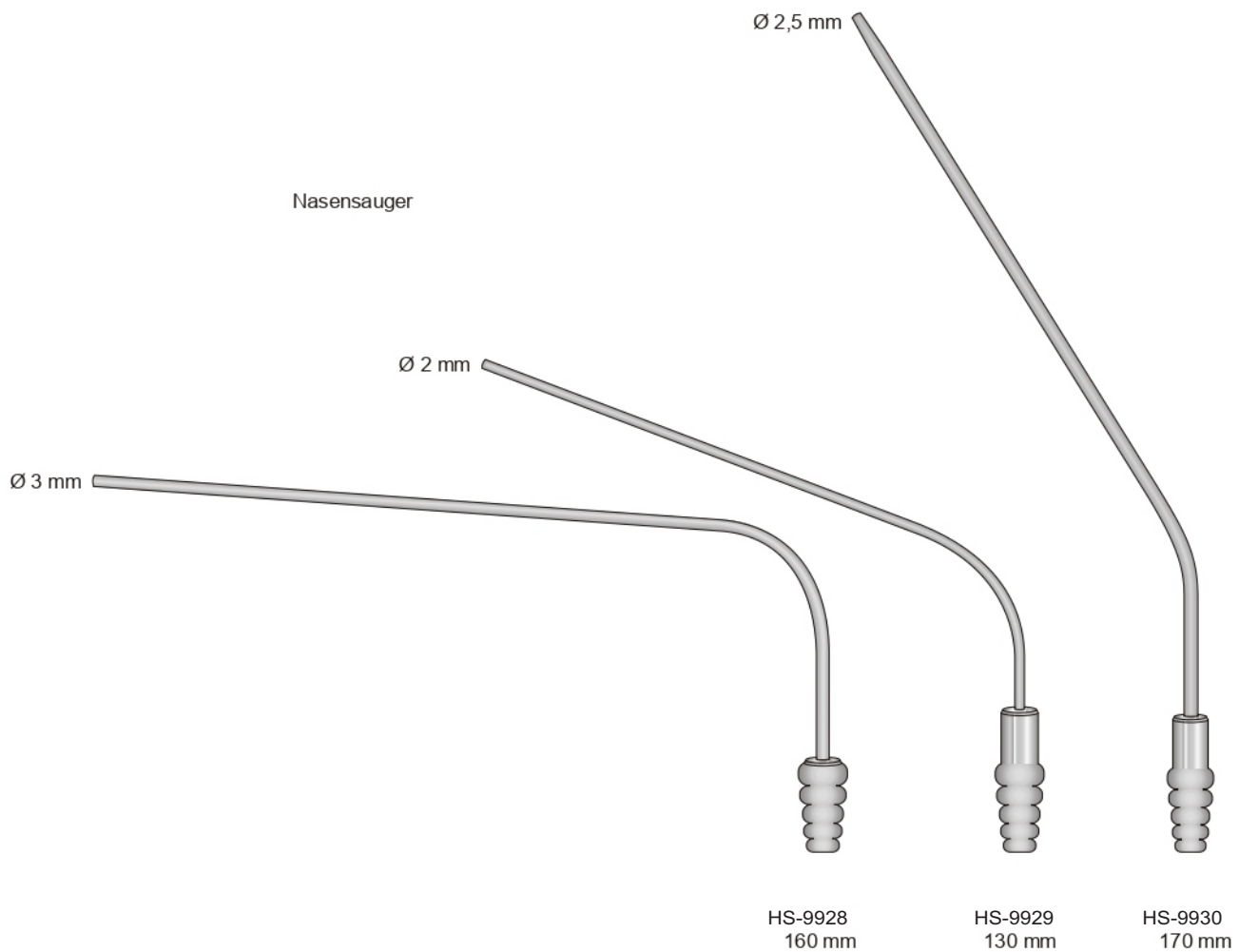



Char. 6	= 2 mm
Char 7	= 2,5 mm
Char 9	= 3 mm
Char 10	= 3,3 mm
Char 12	= 4 mm
Char 15	= 5 mm

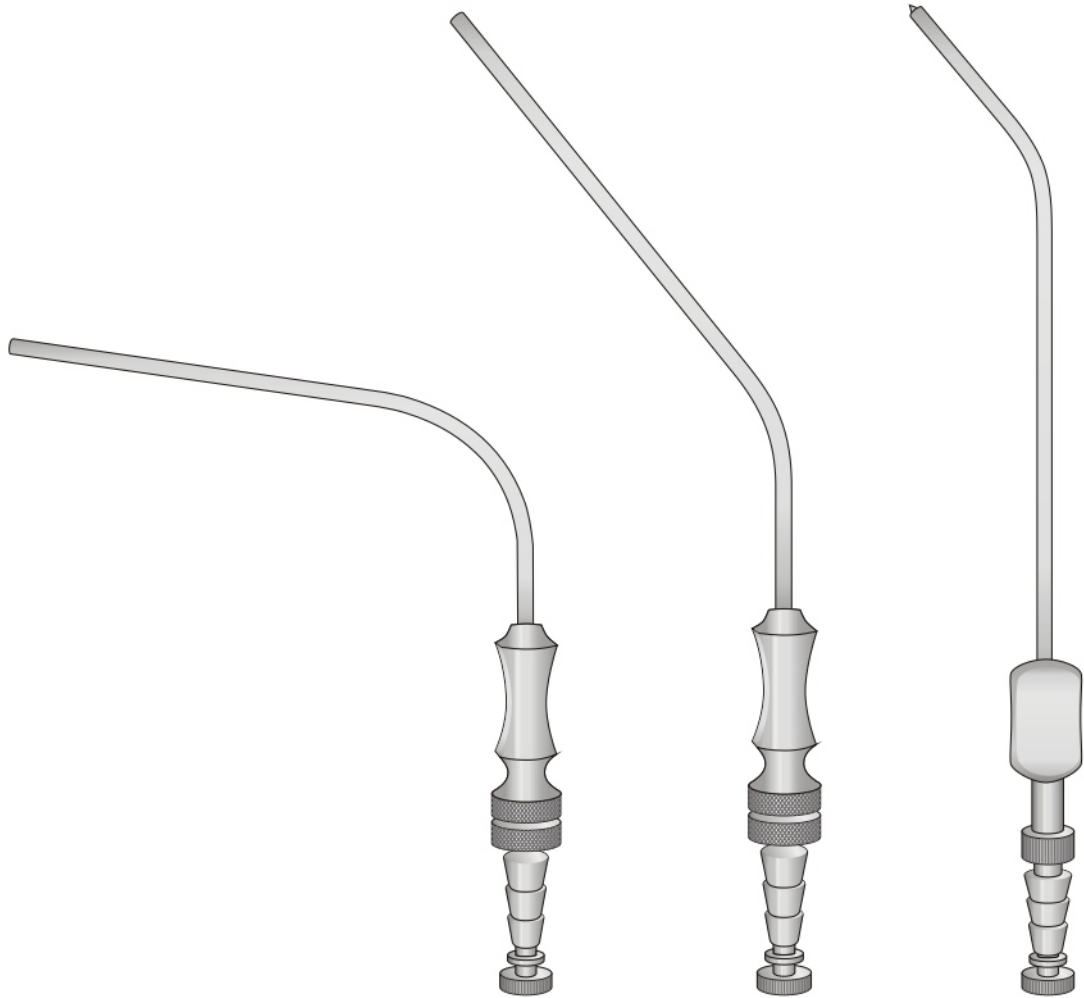

**FERGUSSON**  
 HS-9931-1 Ch. 6  
 HS-9931-2 Ch. 7  
 HS-9931-3 Ch. 9  
 HS-9931-4 Ch. 12  
 HS-9931-5 Ch. 15  
 180 mm

**FRAZIER**  
 HS-9932-1 Ch. 6  
 HS-9932-2 Ch. 7  
 HS-9932-3 Ch. 9  
 HS-9932-4 Ch. 12  
 HS-9932-5 Ch. 15  
 180 mm

**PLESTER**  
 HS-9933-1 Ch. 6  
 HS-9933-2 Ch. 7  
 HS-9933-3 Ch. 9  
 HS-9933-4 Ch. 12  
 HS-9933-5 Ch. 15  
 200 mm

Char. 3	= 1 mm
Char 5	= 1,7 mm
Char 7	= 2,5 mm
Char 10	= 3,3 mm
Char 12	= 4 mm

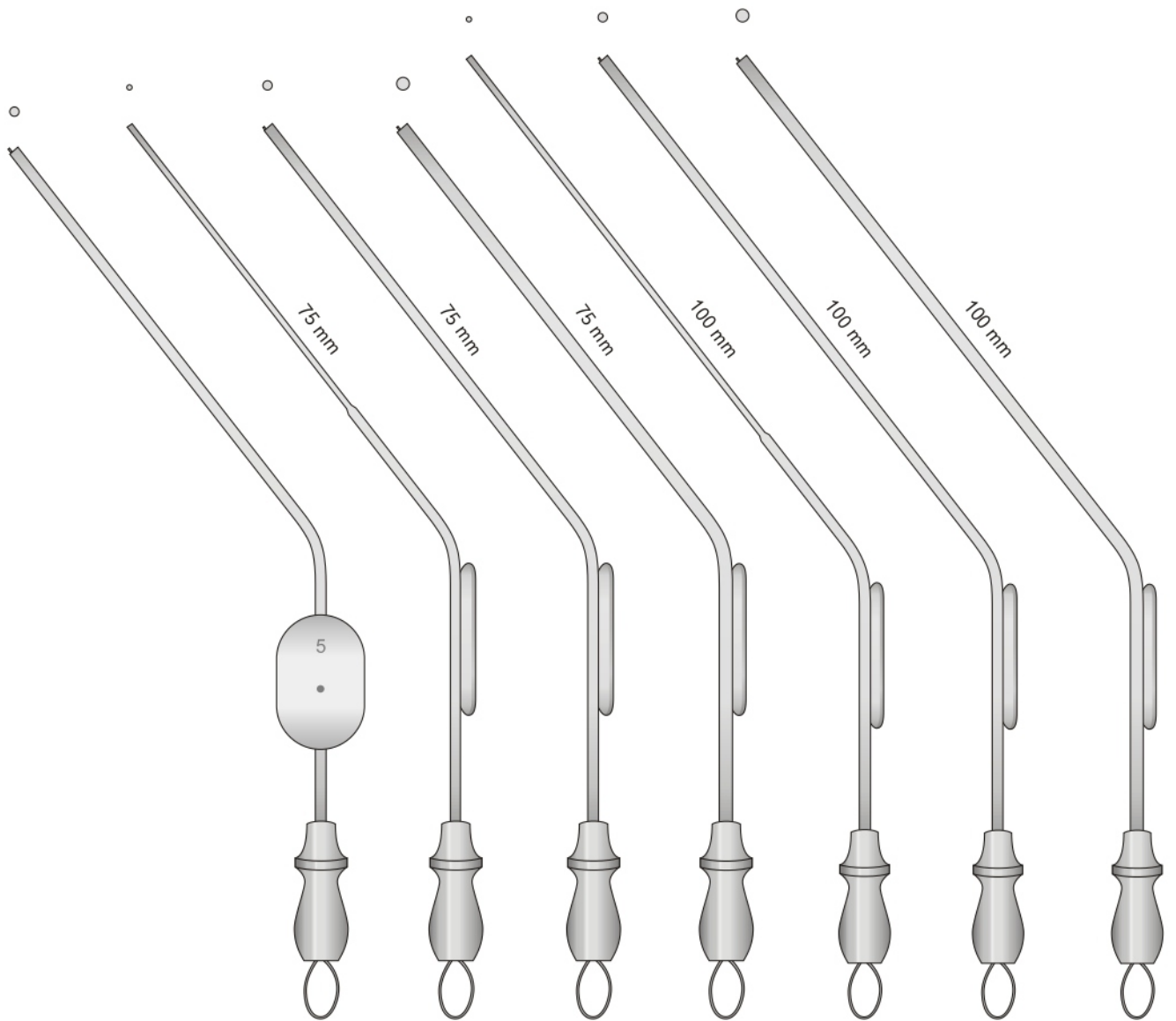

BELLUCCI  
HS-9934  
Charr. 5

BARON  
HS-9935-1  
Charr. 3

BARON  
HS-9935-2  
Charr. 5

BARON  
HS-9935-3  
Charr. 7

BARON  
HS-9935-4  
Charr. 3

BARON  
HS-9935-5  
Charr. 5

BARON  
HS-9935-6  
Charr. 7

Char. 3	= 1 mm
Char 5	= 1,7 mm
Char 7	= 2,5 mm
Char 10	= 3,3 mm
Char 12	= 4 mm

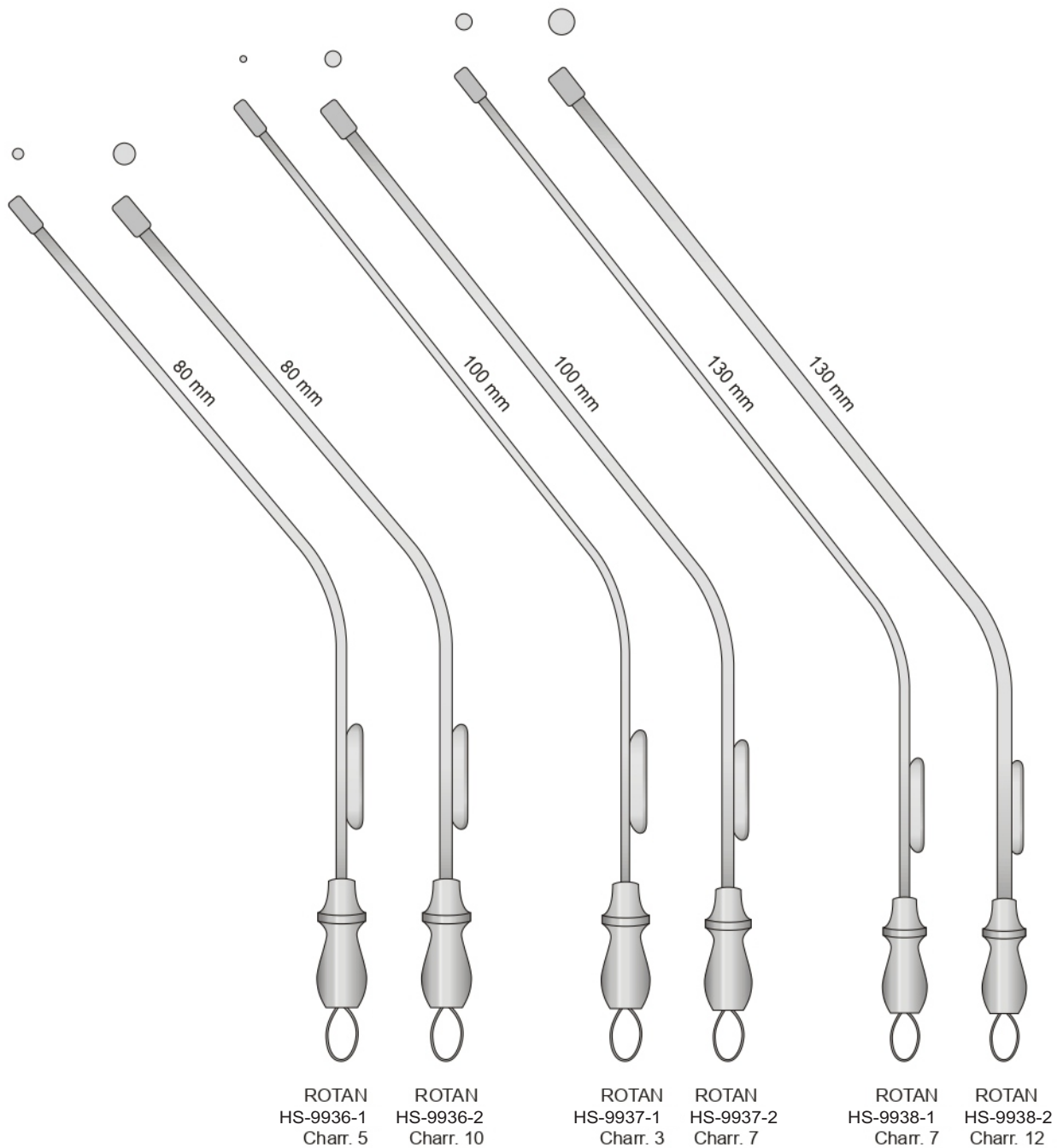

Char. 3	= 1 mm
Char 5	= 1,7 mm
Char 7	= 2,5 mm
Char 10	= 3,3 mm
Char 12	= 4 mm
Char 14	= 4,6 mm

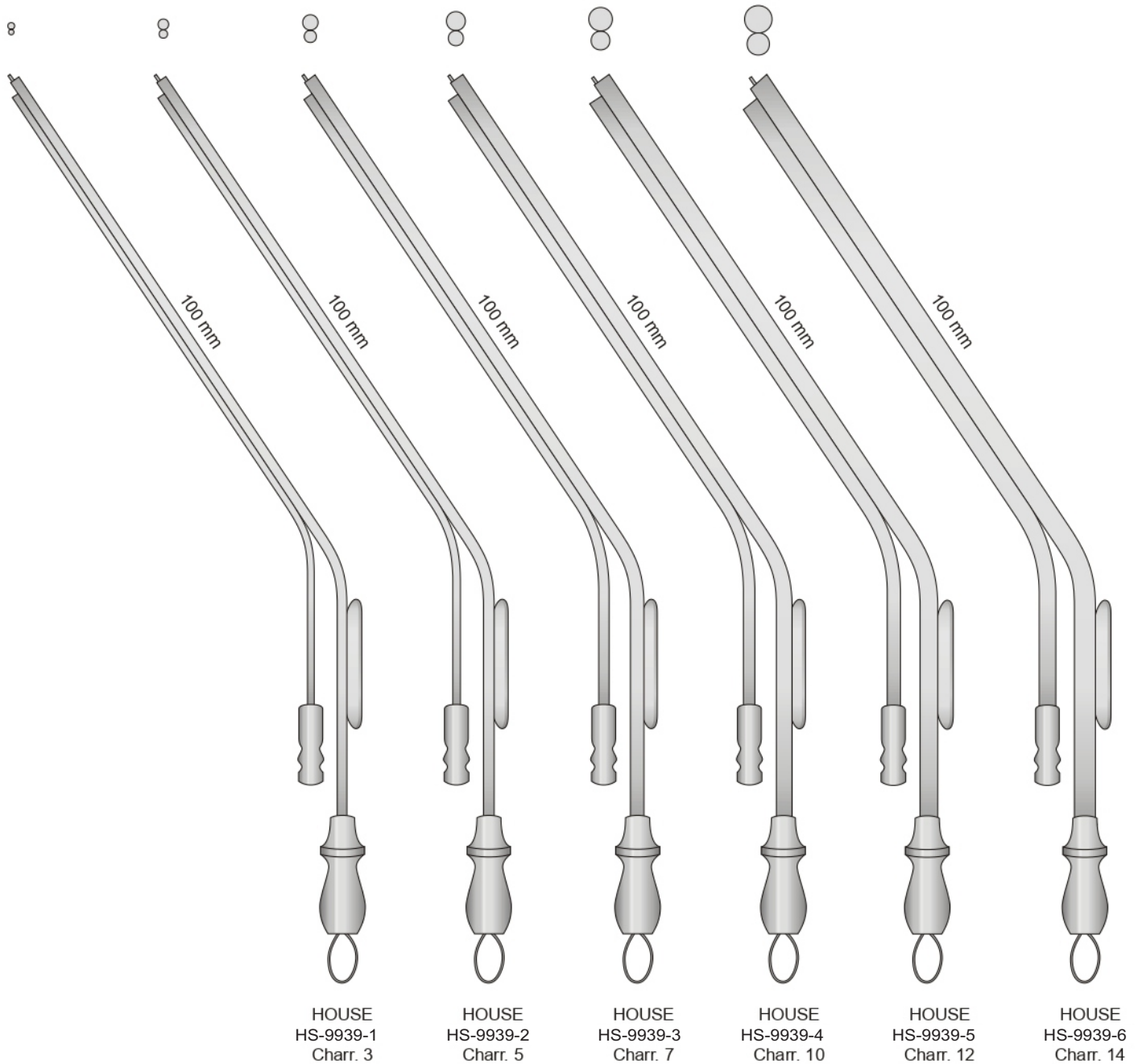

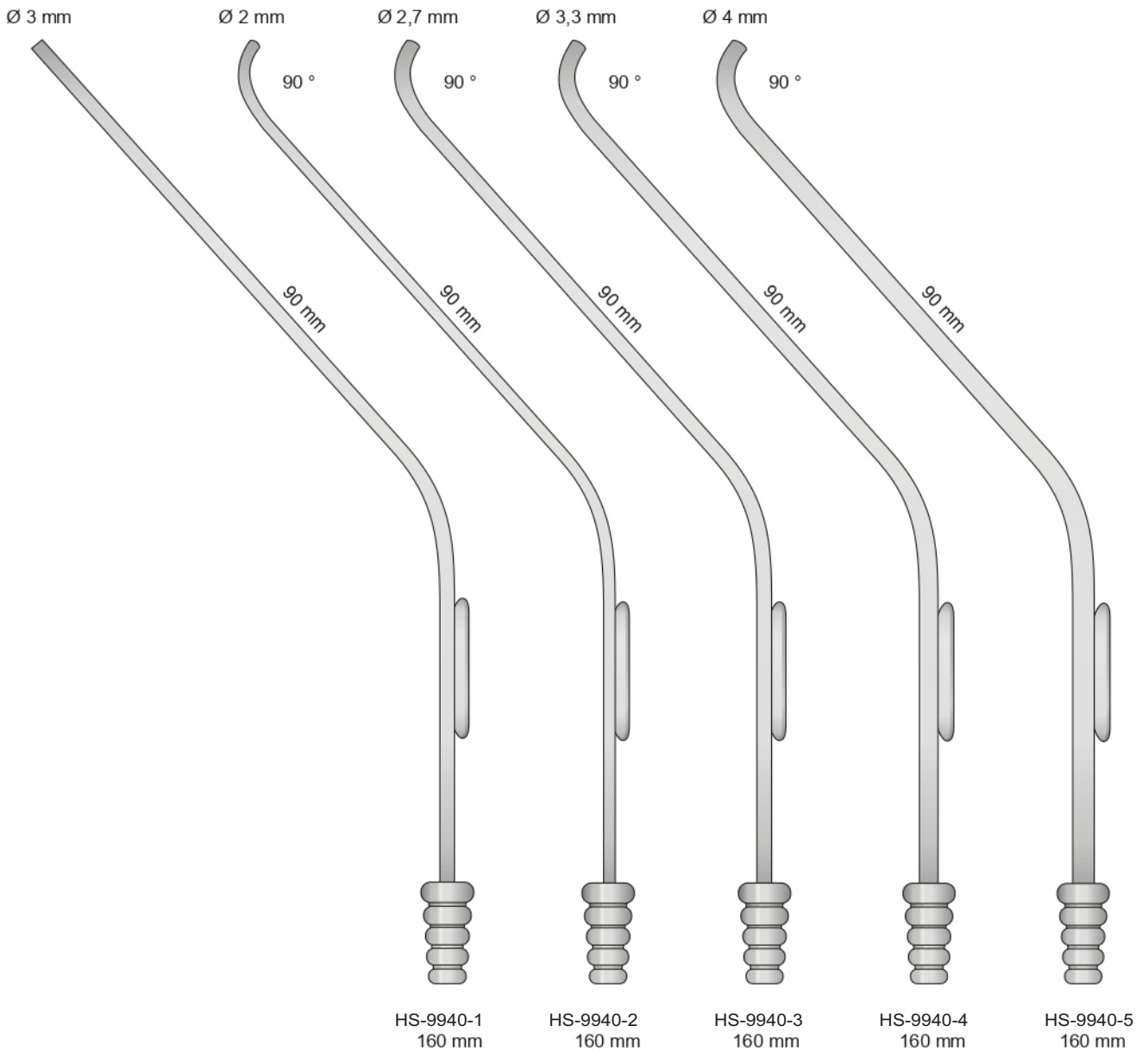





Malleabile  
Malleable  
Biegsam  
Malléables  
Malleable  
Ø 3 mm



WERTHEIMER  
HS-9941  
160 mm

**Cromata nera**

Malleabile  
Malleable  
Biegsam  
Malléables  
Malleable  
Ø 3 mm

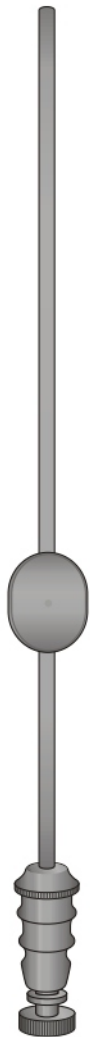

FRAZIER  
HS-9942  
160 mm

Malleabile  
Malleable  
Biegsam  
Malléables  
Malleable  
Ø 3 mm

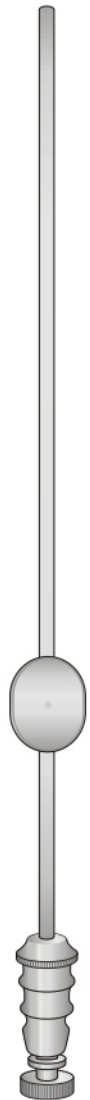

WERTHEIMER  
HS-9943  
200 mm

**Cromata nera**

Malleabile  
Malleable  
Biegsam  
Malléables  
Malleable  
Ø 3 mm

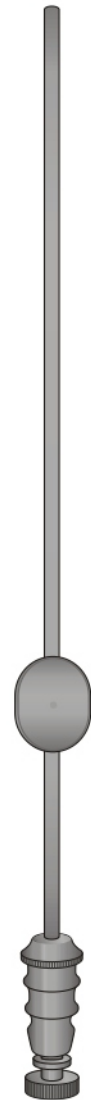

FRAZIER  
HS-9944  
200 mm

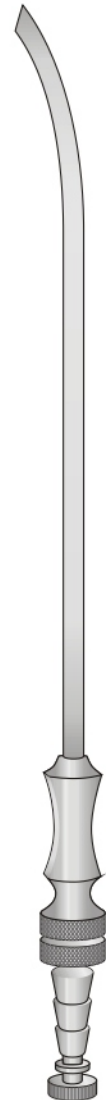

ADSON  
HS-9945-1 ch. 12  
HS-9945-2 ch. 15  
210 mm

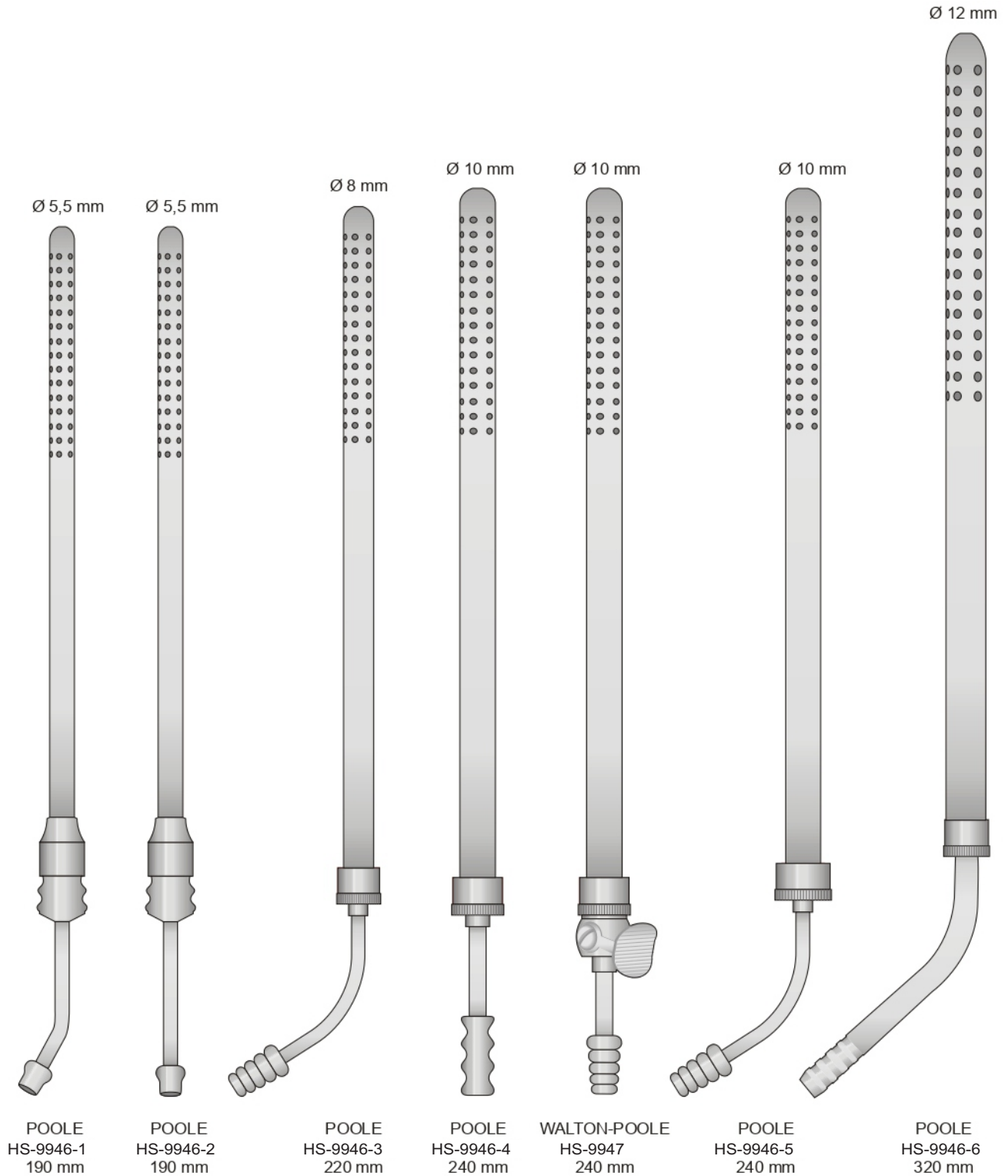

Set completo con:  
Set complete with:  
Kompletset mit:  
Set complet avec:  
Set completos con:

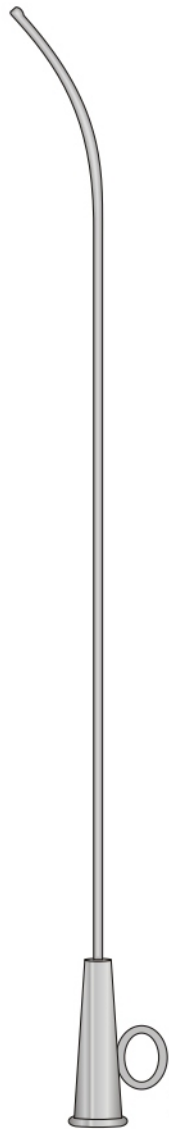

HS-9948-1 Ø 1,5 mm  
HS-9948-2 Ø 2 mm  
HS-9948-3 Ø 2,5 mm

HARTMANN  
HS-9948  
170 mm

Ø 4 mm

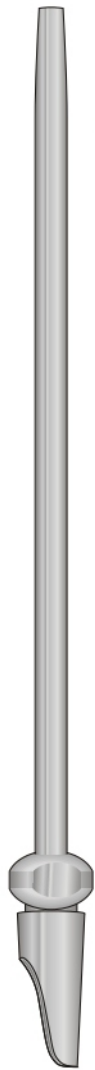

HS-9949  
160 mm

Ø 4 mm

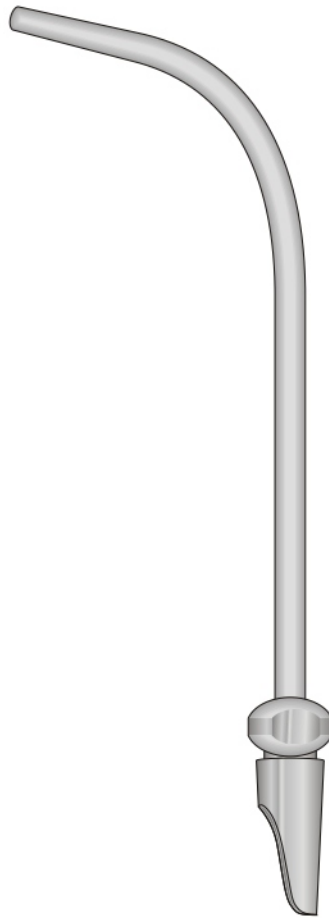

HS-9950  
145 mm

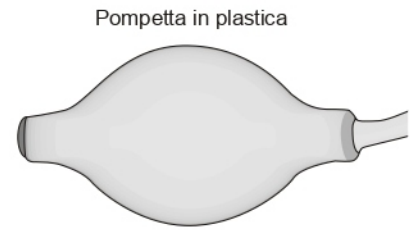

HS-9951

Raccordo in silicone per canule  
Autoclavabile

2 mt.

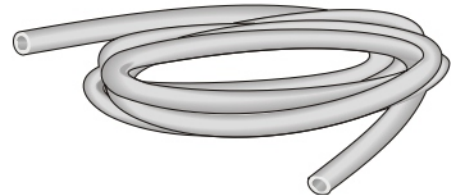

HS-9952  
2 mt.

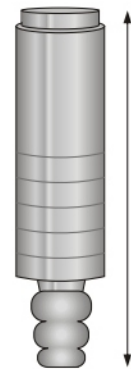

65 mm

HS-9953  
65 mm

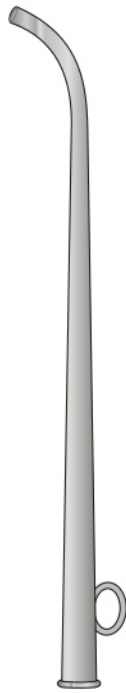

- HS-9954-1 Ø 3,0 mm
- HS-9954-2 Ø 3,5 mm
- HS-9954-3 Ø 4,0 mm
- HS-9954-4 Ø 4,5 mm
- HS-9954-5 Ø 5,0 mm

ITARD  
HS-9954  
145 mm

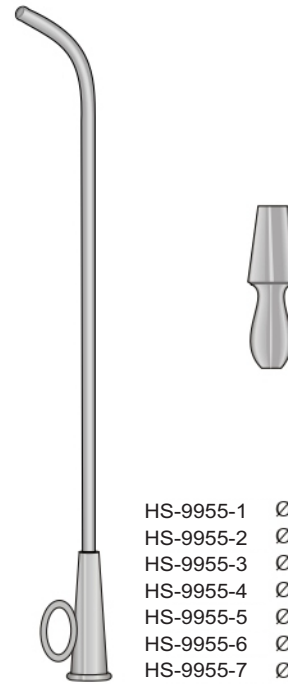

- HS-9955-1 Ø 2,0 mm
- HS-9955-2 Ø 2,5 mm
- HS-9955-3 Ø 3,0 mm
- HS-9955-4 Ø 3,5 mm
- HS-9955-5 Ø 4,0 mm
- HS-9955-6 Ø 4,5 mm
- HS-9955-7 Ø 5,0 mm

HARTMANN  
HS-9955  
150 mm



- HS-9955-1 Ø 1,5 mm
- HS-9955-2 Ø 1,7 mm
- HS-9955-3 Ø 2,0 mm
- HS-9955-4 Ø 2,5 mm
- HS-9955-5 Ø 3,0 mm

SIEBENMANN  
HS-9955  
150 mm

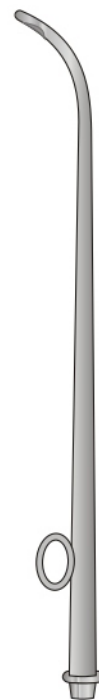

- HS-9956-1 Ø 1,5 mm
- HS-9956-2 Ø 1,7 mm
- HS-9956-3 Ø 2,0 mm
- HS-9956-4 Ø 2,5 mm
- HS-9956-5 Ø 3,0 mm

SIEBENMANN  
HS-9956  
150 mm



Ø Interno  
Ø Inside  
Ø Innen  
Ø Intérieur  
Ø Interior

Ø Interno  
Ø Inside  
Ø Innen  
Ø Intérieur  
Ø Interior

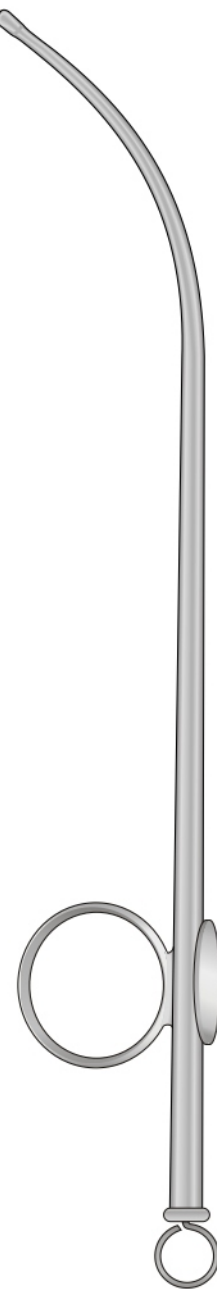
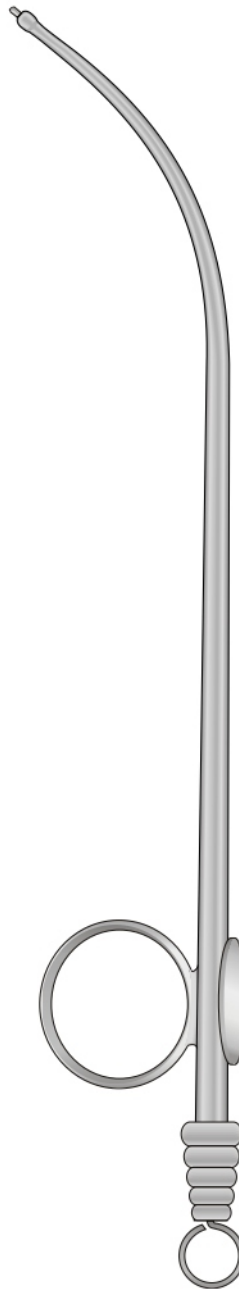
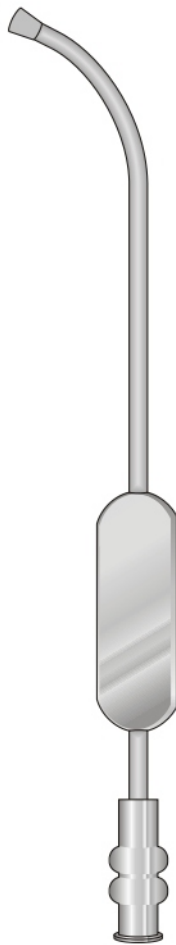
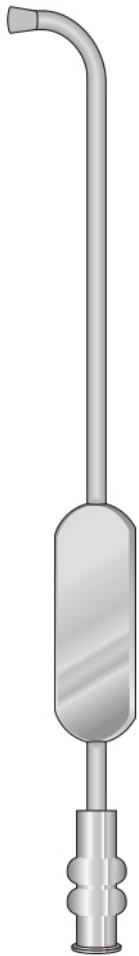

**KILLIAN**  
HS-9957-1 Ø 3 mm  
HS-9957-2 Ø 4 mm  
145 mm  
HS-9957

**KILLIAN**  
HS-9957-3 Ø 3 mm  
HS-9957-4 Ø 4 mm  
145 mm

**MAGILL**  
HS-9958-1 Ø 1 mm  
200 mm  
HS-9958

**MAGILL**  
HS-9958-2 Ø 1 mm  
HS-9958-3 Ø 2 mm  
HS-9958-4 Ø 3 mm  
200 mm



Steriliser bar  
Autoclavable  
Autoclavabile  
Esterilizable  
Stérilisable

Handwaschbürste  
Nail brush  
Spazzola per unghie  
Cepillo de uñas  
Brosse à ongles

Scovolini per pulizia canule  
Kanülenreinigungs-bürsten



HS-9962  
4 x 11 cm



PELTON-CRANE  
HS-9959  
140 mm

PELTON-CRANE  
HS-9960  
160 mm



HS-9961-1  
120 mm



HS-9961-2  
235 mm

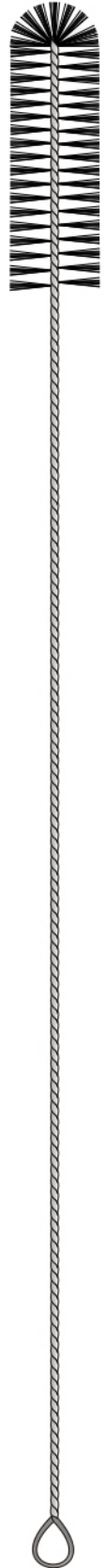

HS-9961-3  
330 mm



Sonde per varici, malleabili - Probe for varicose veins, malleable  
Krampfadersonden, biegsam - Sondes pour varices, malléables  
Sondas para vârices, maleables

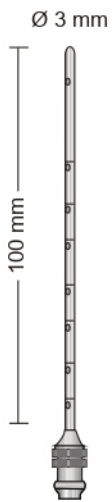

HS-9963  
FRAZIER

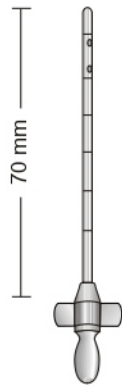

HS-9963-1 - Ø 2 mm  
HS-9963-2 - Ø 2,5 mm



BABCOCK

HS-9964-1 - 400 mm  
HS-9964-2 - 500 mm  
HS-9964-3 - 650 mm  
HS-9964-4 - 800 mm

Aghi per tonsille  
Tonsil needles  
Tonsillenkantülen  
Aiguilles pour les amygdales  
Agujas para amígdalas



HS-9965  
120 mm



HS-9966  
110 mm



HS-9967  
110 mm

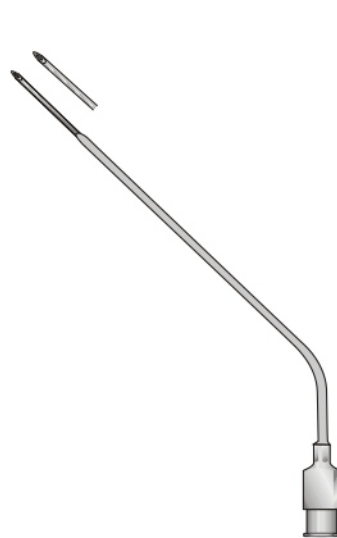

SEPTUN-NADEL  
HS-9968  
110 mm



HS-9969  
110 mm



Canule per irrigazione dei vasi, malleabili  
Vessel irrigating cannulas, malleable  
Gefäß-spülkanülen, biegsam  
Canules d'irrigation pour vaisseaux, malléables  
Cánulas de irrigación para vasos, maleables

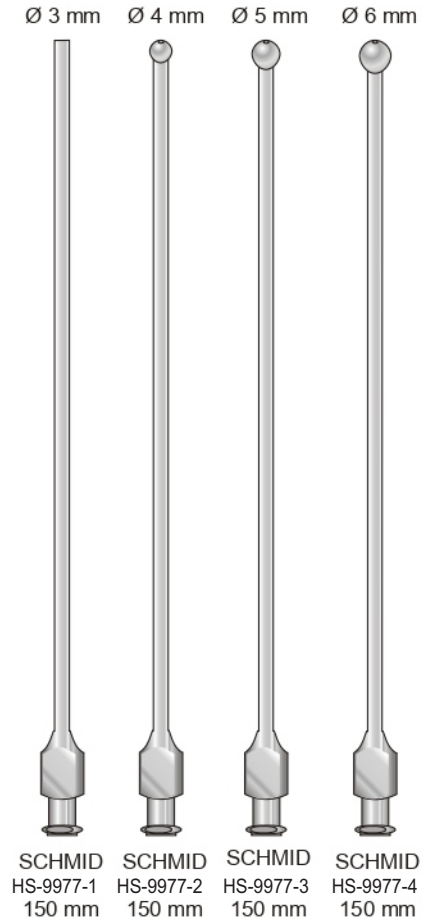
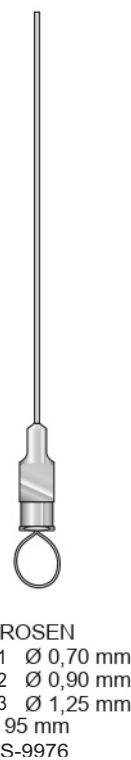
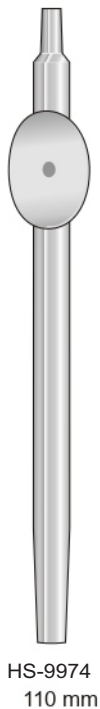



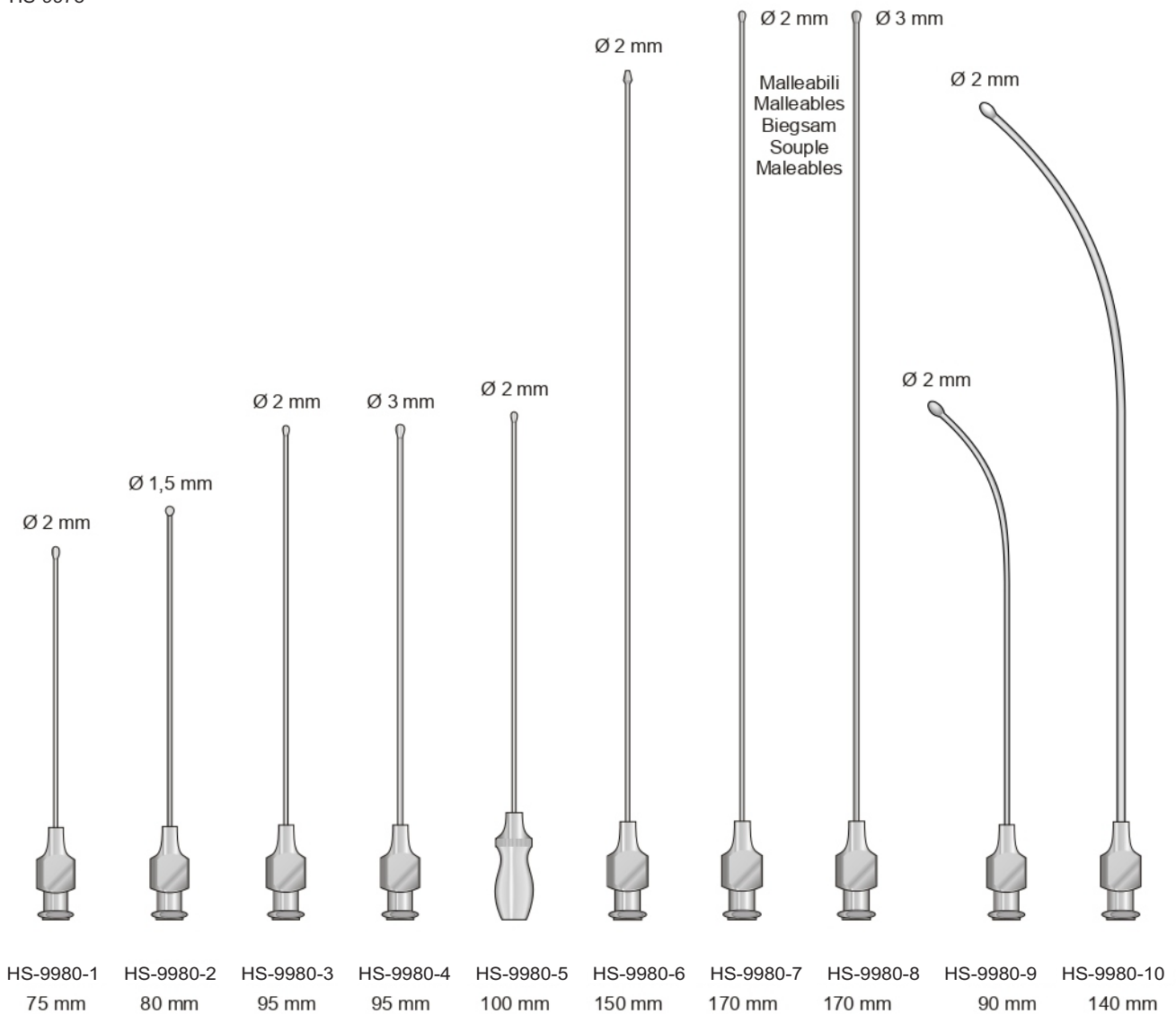
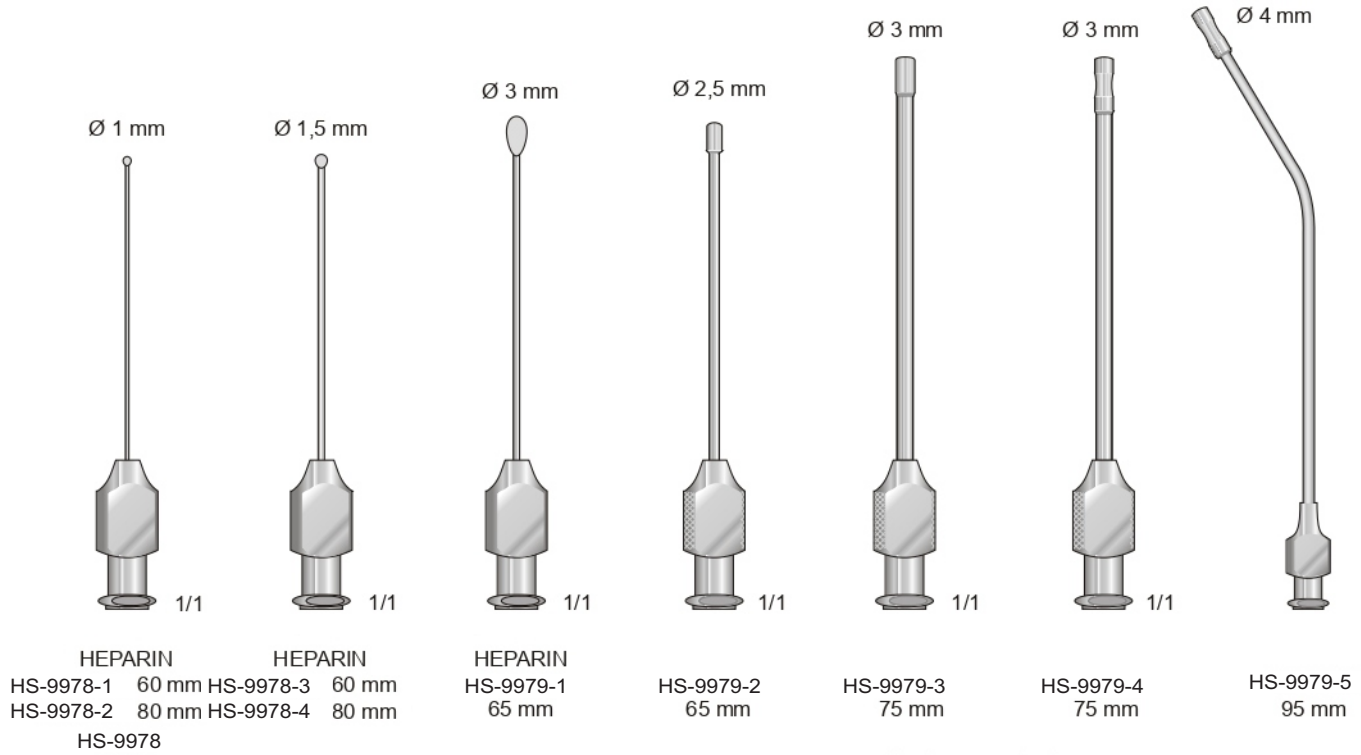



**Aghi malleabili**

0,5 mm



HS-9981-1  
150 mm

0,7 mm



HS-9981-2  
150 mm

1 mm



HS-9981-3  
150 mm

1,5 mm



HS-9981-4  
150 mm

2 mm



HS-9981-5  
150 mm

2,5 mm



HS-9981-6  
150 mm

3 mm



HS-9981-7  
150 mm

**Aghi malleabili con due fori**

0,5 mm



HS-9981-8  
150 mm

0,7 mm



HS-9981-9  
150 mm

1 mm



HS-9981-10  
150 mm

1,5 mm



HS-9981-11  
150 mm

2 mm



HS-9981-12  
150 mm

2,5 mm



HS-9981-13  
150 mm

3 mm

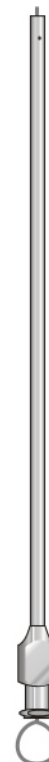

HS-9981-14  
150 mm

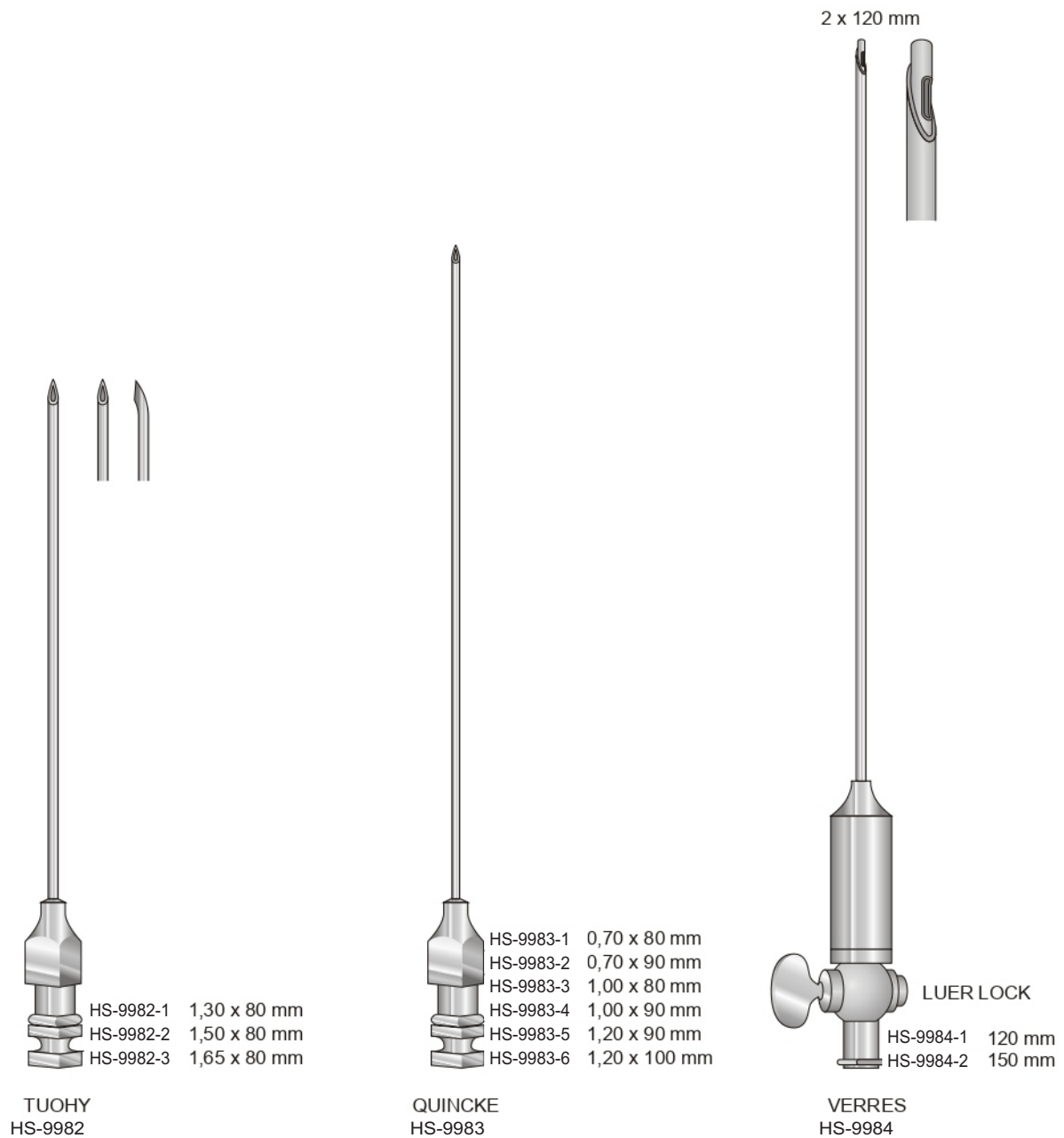

**Manufacturer & Exporter  
Of Surgical, Dental & Beauty Instruments.**



# Health Fast Surgical

Surgical Manufacturer Company

+92 (342) 880 9017

+92 (342) 880 9017

info@healthfastsurgical.com

www.healthfastsurgical.com

Dogra Khurd, P.O Harrar Sialkot-51310 Pakistan.



ISO  
9001:2008

