

Surgical

INSTRUMENTS CATALOGUE



*Needle Holders
Ligature Needles*



Health Fast Surgical

Surgical Manufacturer Company

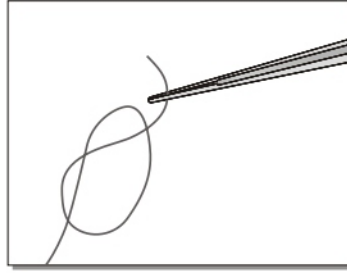

BROCK
 HS-8301
 130 mm

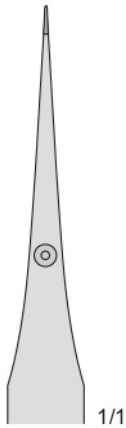

1/1

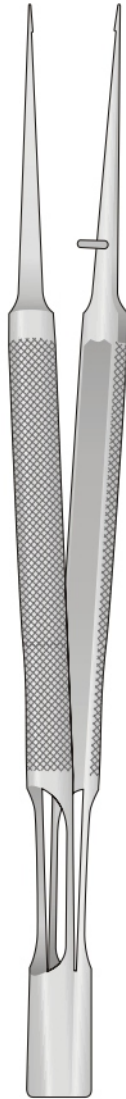

BROCK
 HS-8302
 150 mm

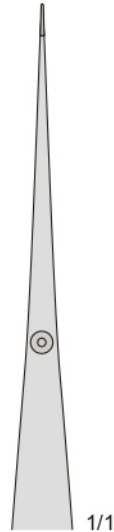

1/1

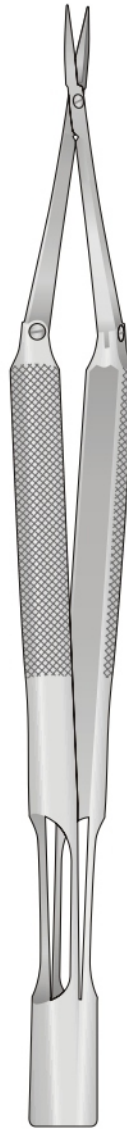

BROCK
 HS-8303
 150 mm



1/1

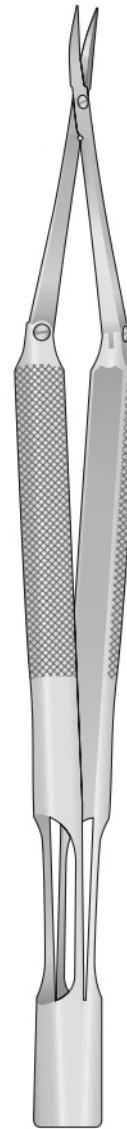

BROCK
 HS-8304
 150 mm



1/1



Con morso liscio
Smooth jaws
Glattes Maul
A' mors lisses
Mandibula lisa

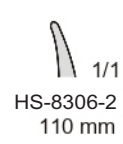
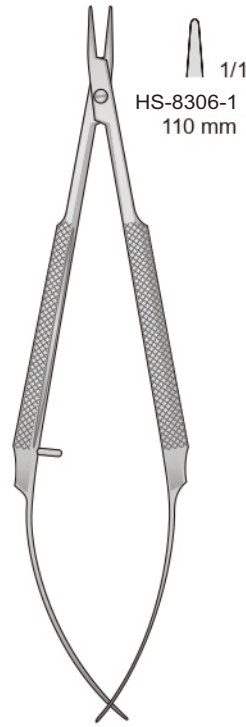
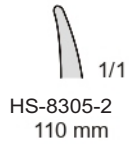
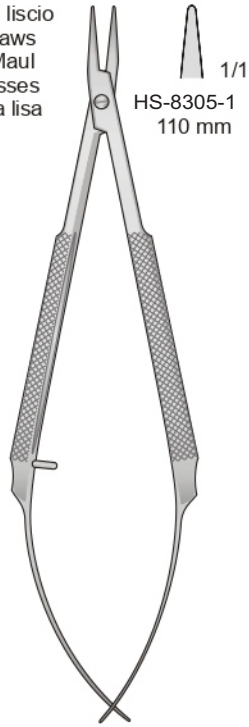

HS-8305
110 mm

HS-8306
110 mm

Con morso liscio
Smooth jaws
Glattes Maul
A' mors lisses
Mandibula lisa

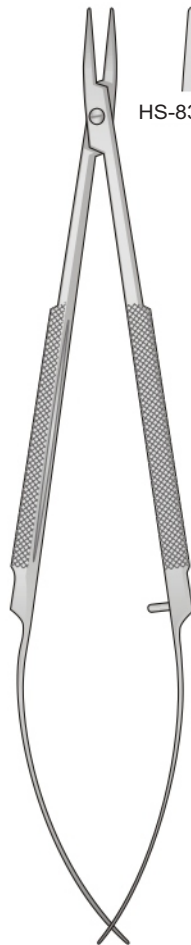
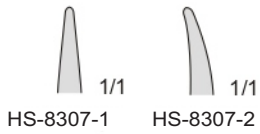
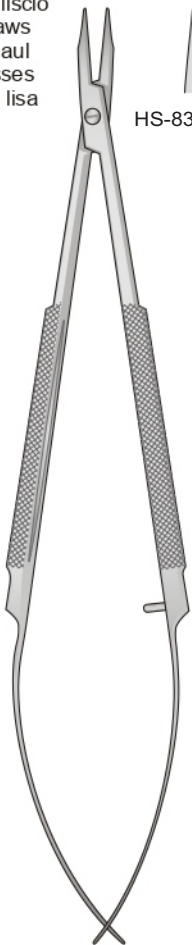

Con morso zigrinato fine
Fine serrated jaws
Feingerieftes Maul
Mors stries fins
Bocas estriadas finas

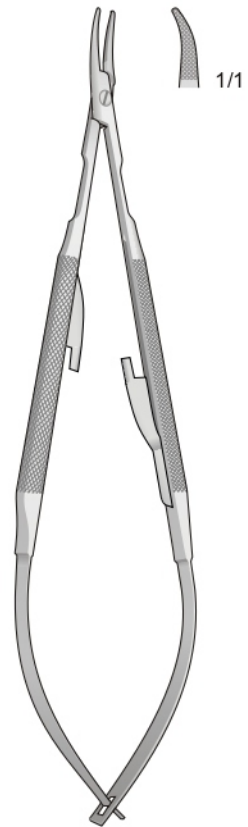

HS-8307
150 mm

HS-8308
150 mm

BARRAQUER
HS-8309
135 mm



Con morso liscio - Smooth jaws
Glattes Maul - A' mors lisses - Mandibula lisa

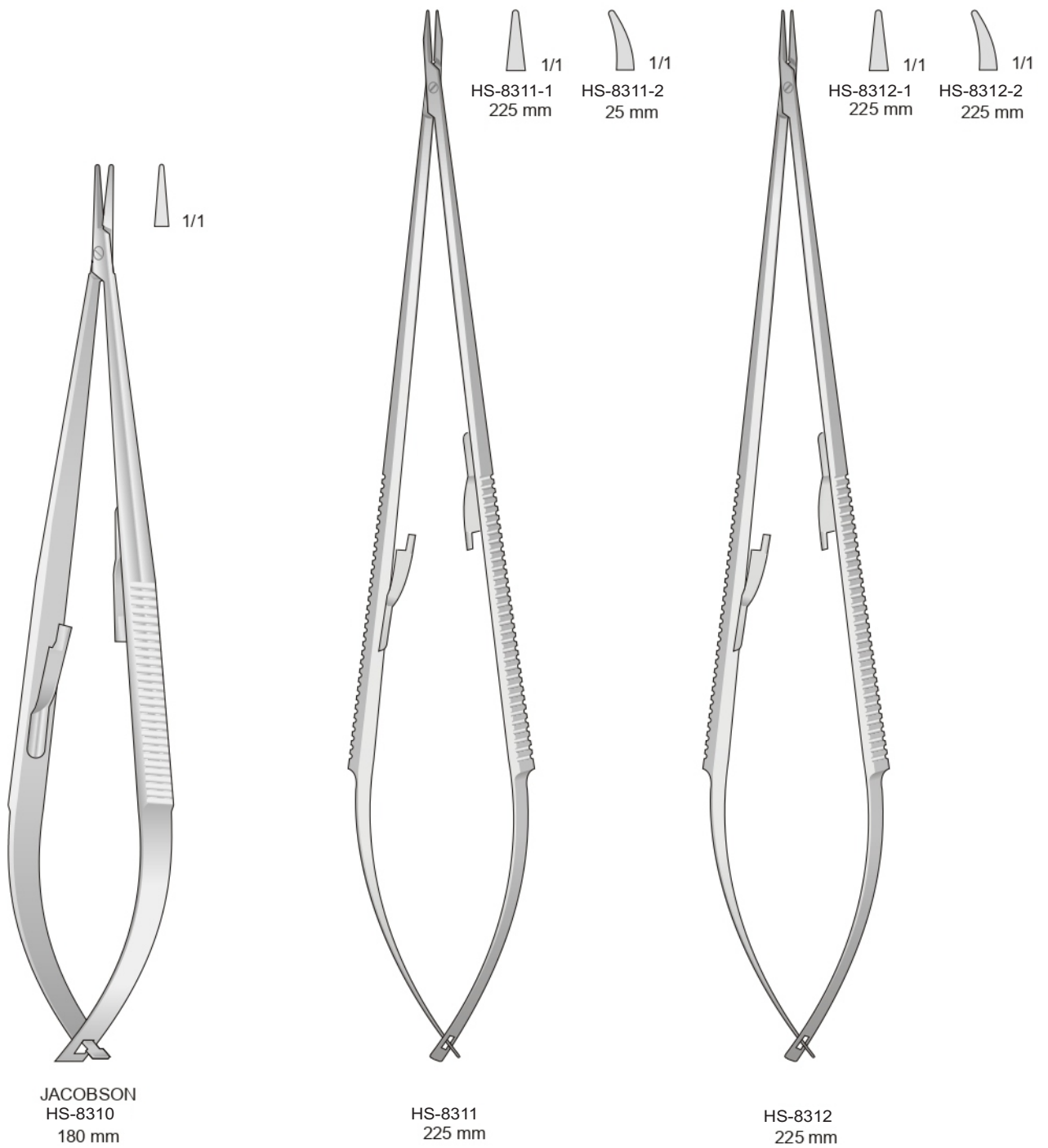

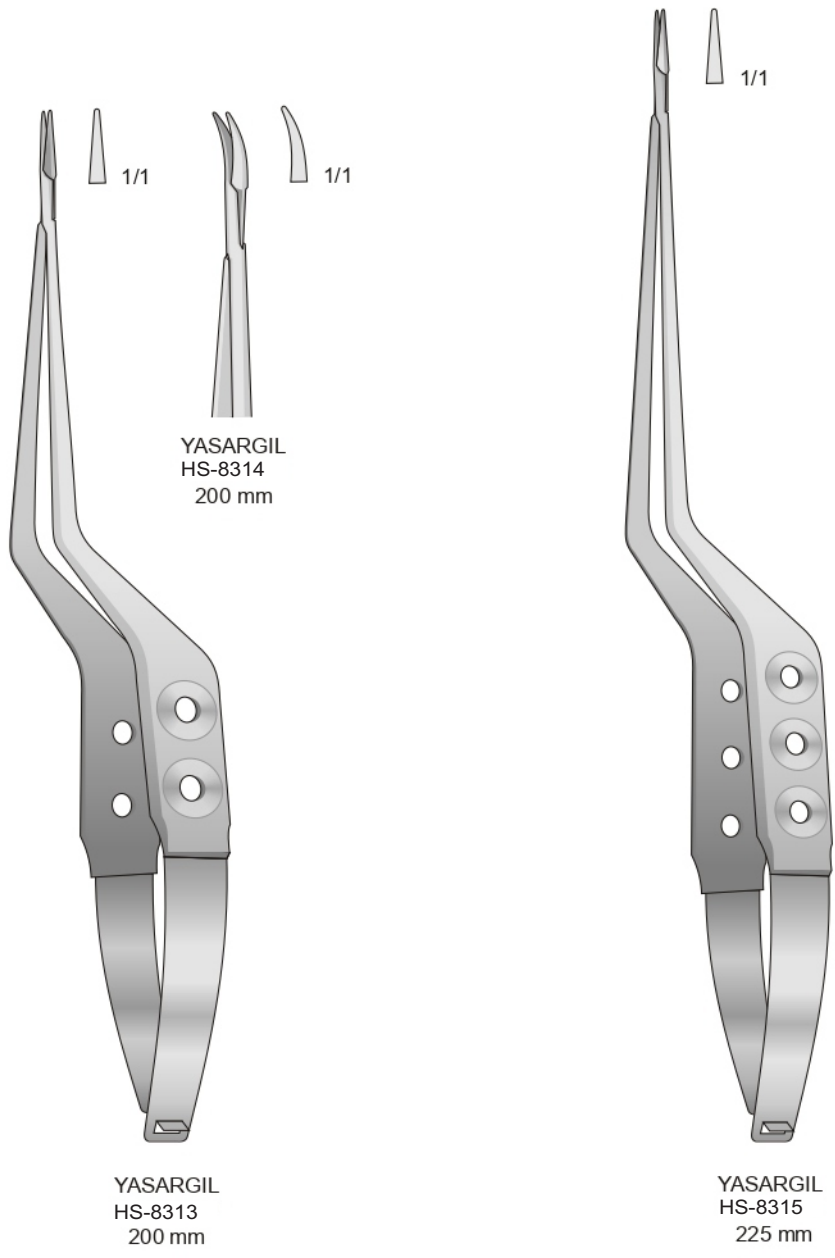

Needle Holders

Portaghi con inserti al tungsteno
Needle Holders with tungsten-carbide inserts
Nadelhalter mit Hartmetalleinlagen
Porte aiguilles avec plaquettes en carbure de tungstène
Portaaguja con plaquitas de carburo de tungsteno

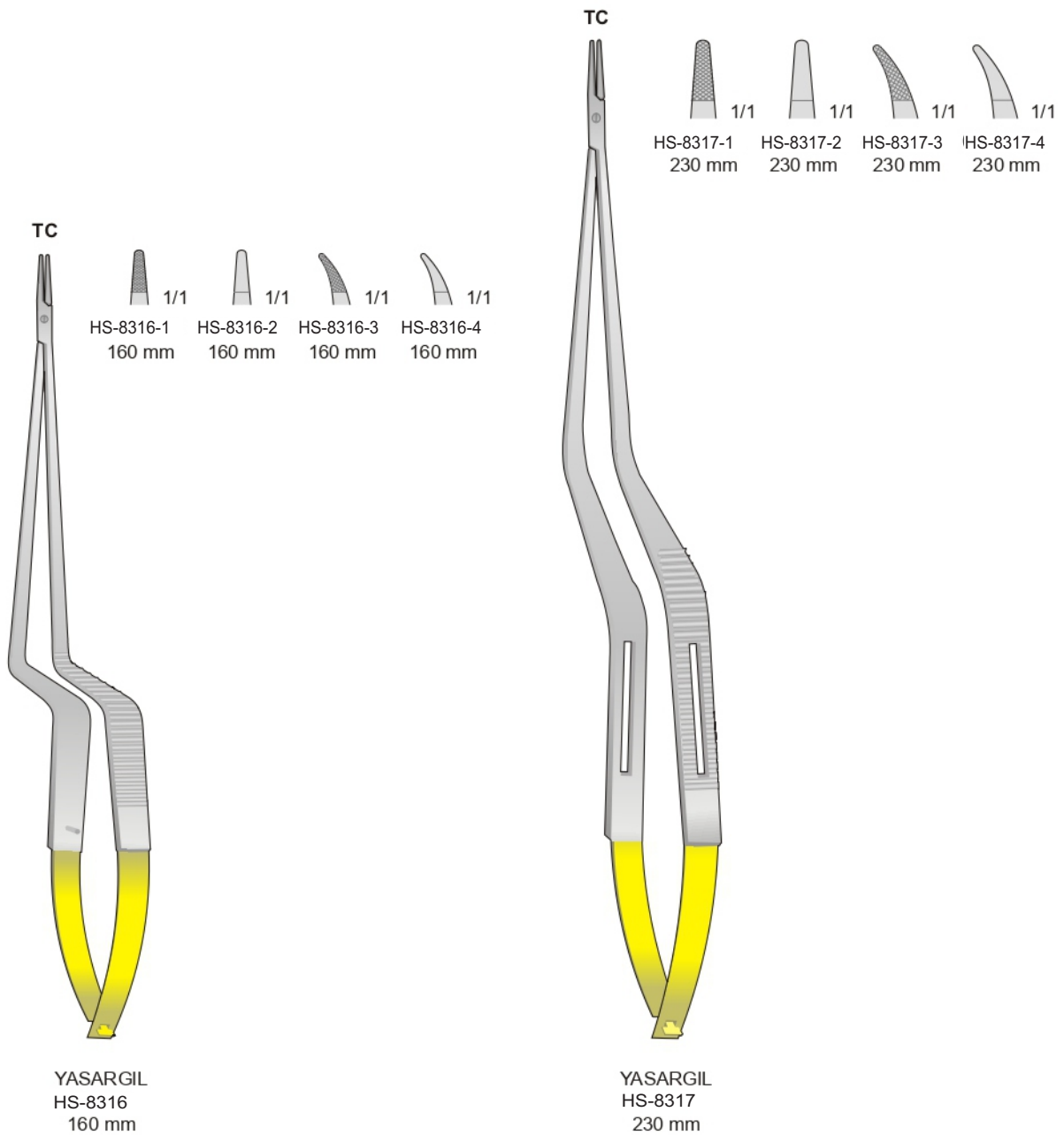



HS-8318-1
140 mm

HS-8318-2
140 mm

07-330
140 mm

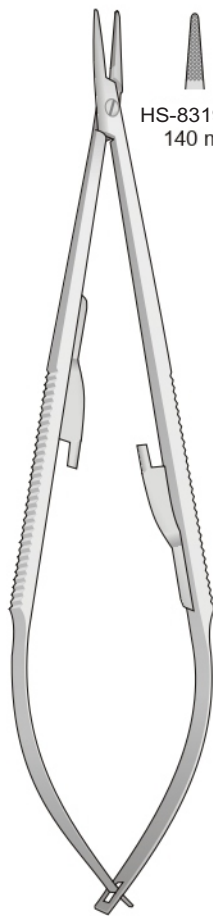

HS-8319-1
140 mm

HS-8319-2
140 mm

CASTROVIEJO
 HS-8319
 140 mm

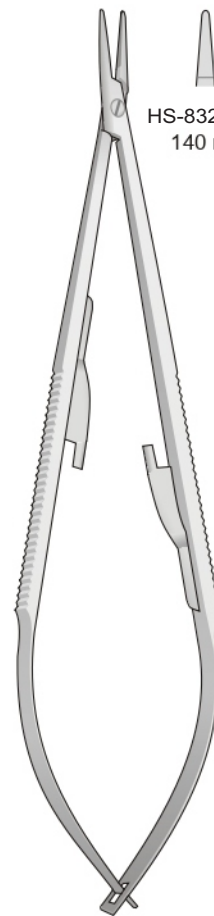

HS-8320-1
140 mm

HS-8320-2
140 mm

CASTROVIEJO
 HS-8320
 140 mm

Con morso liscio
 With smooth jaws
 Mit Glatten maul
 Avec mors lisses
 Con mandibula lisa

Portaghi con inserti al tungsteno
 Needle Holders with tungsten-carbide inserts
 Nadelhalter mit Hartmetalleinlagen
 Porte aiguilles avec plaquettes en carbure de tungstène
 Portaagujas con plaquitas de carburo de tungsteno

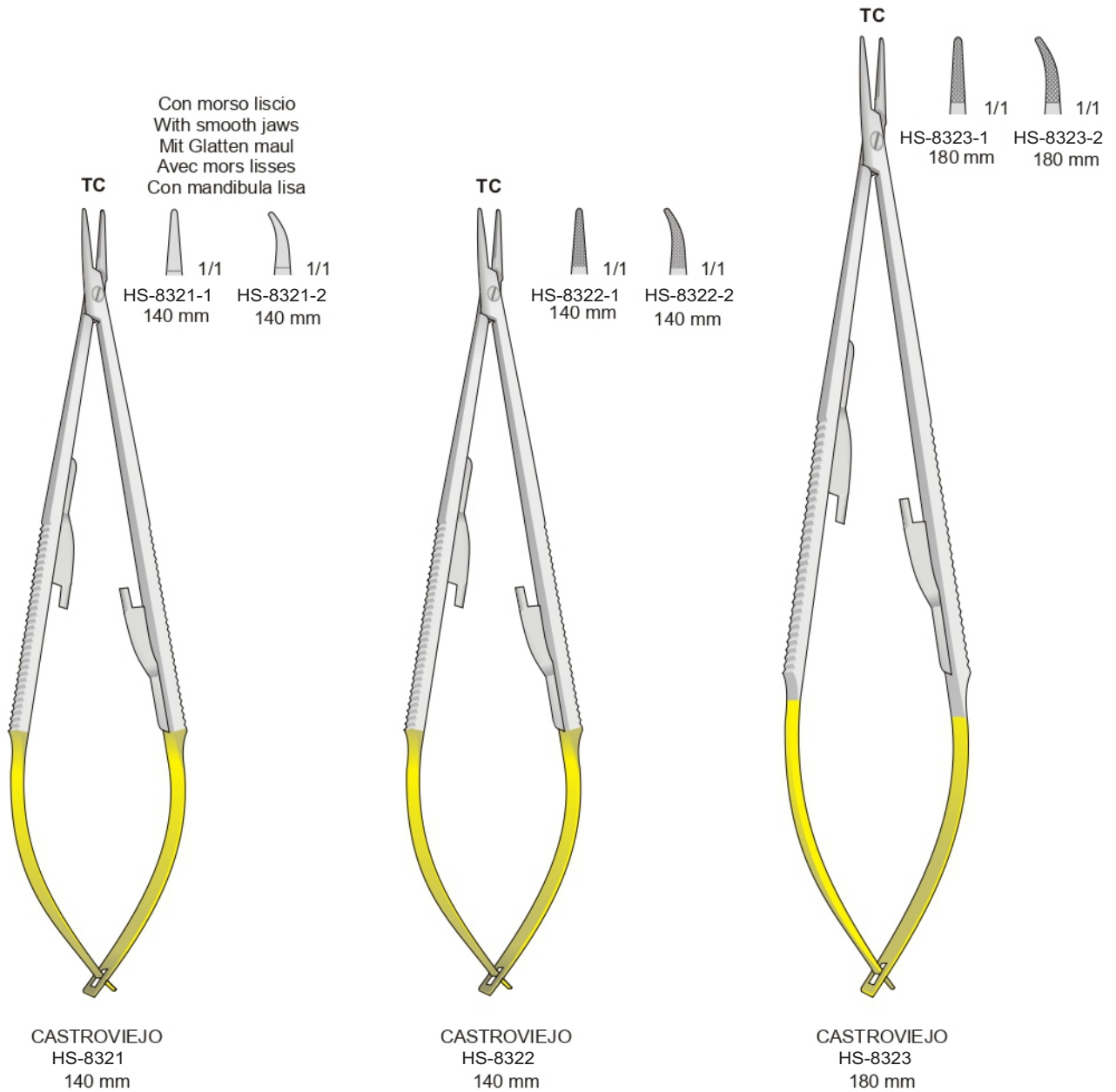



Needle Holders

Portaghi con inserti al tungsteno
Needle Holders with tungsten-carbide inserts
Nadelhalter mit Hartmetalleinlagen
Porte aiguilles avec plaquettes en carbure de tungstène
Portaagujas con plaquitas de carburo de tungsteno

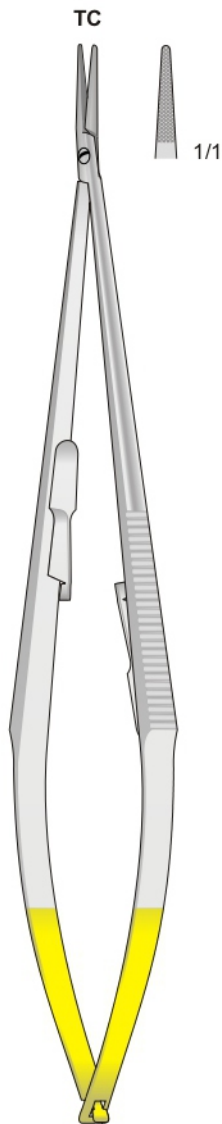

CASTROVIEJO
HS-8324
215 mm

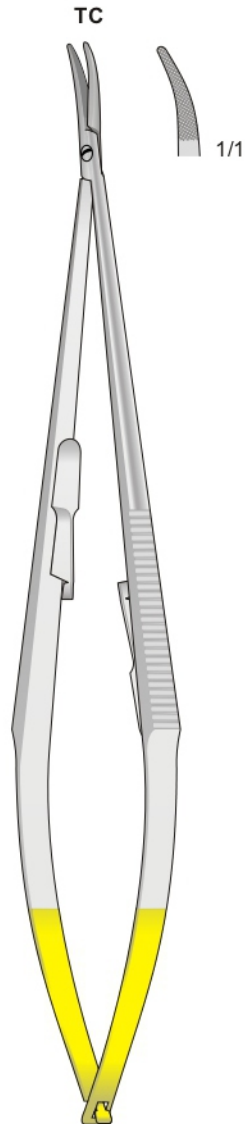

CASTROVIEJO
HS-8325
215 mm

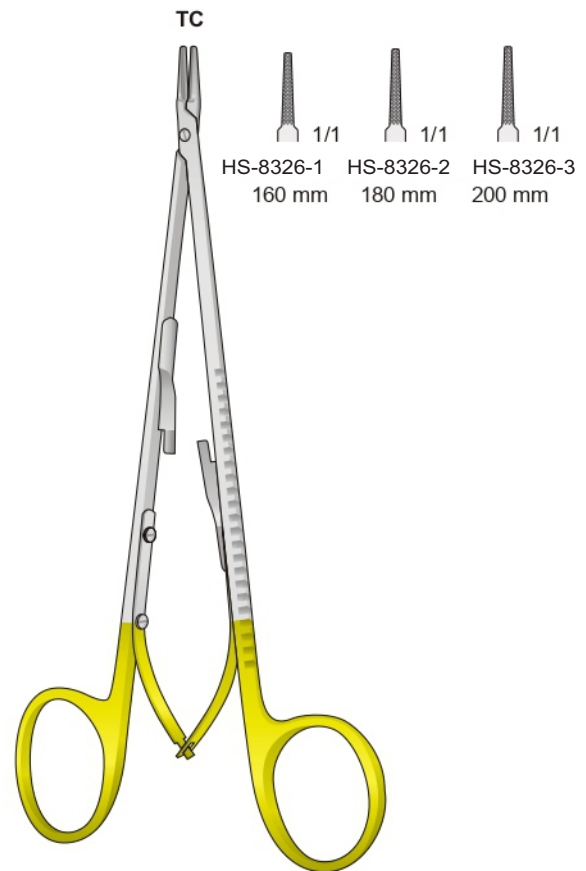

DIETRICH
HS-8326



Con morso liscio
With smooth jaws
Mit Glatten maul
Avec mors lisses
Con mandibula lisa

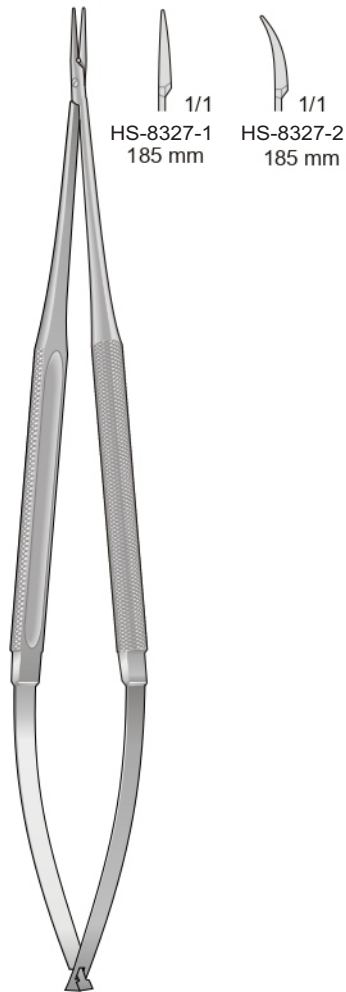

HS-8327
185 mm

Con morso liscio
With smooth jaws
Mit Glatten maul
Avec mors lisses
Con mandibula lisa

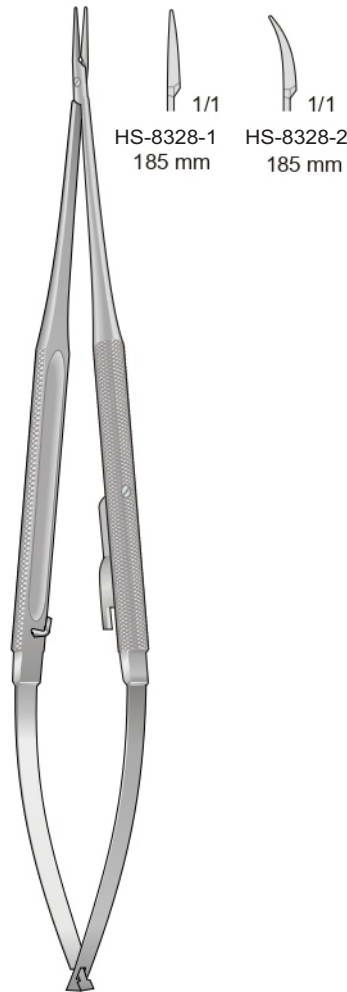

HS-8328
185 mm

Portaghi con inserti al tungsteno
Needle Holders with tungsten-carbide inserts
Nadelhalter mit Hartmetalleinlagen
Porte aiguilles avec plaquettes en carbure de tungstène
Portaagujas con plaquetas de carburo de tungsteno

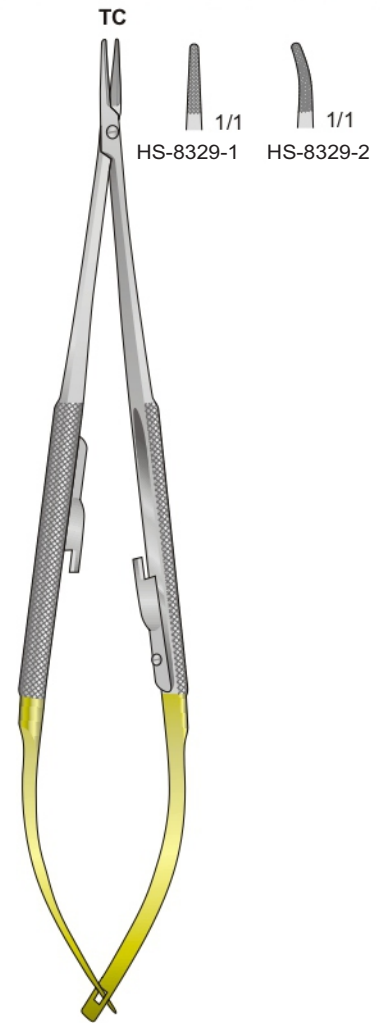

JACOBSON
HS-8329
180 mm

Portaghi con inserti al tungsteno
Needle Holders with tungsten-carbide inserts
Nadelhalter mit Hartmetalleinlagen
Porte aiguilles avec plaquettes en carbure de tungstène
Portaagujas con plaquitas de carburo de tungsteno

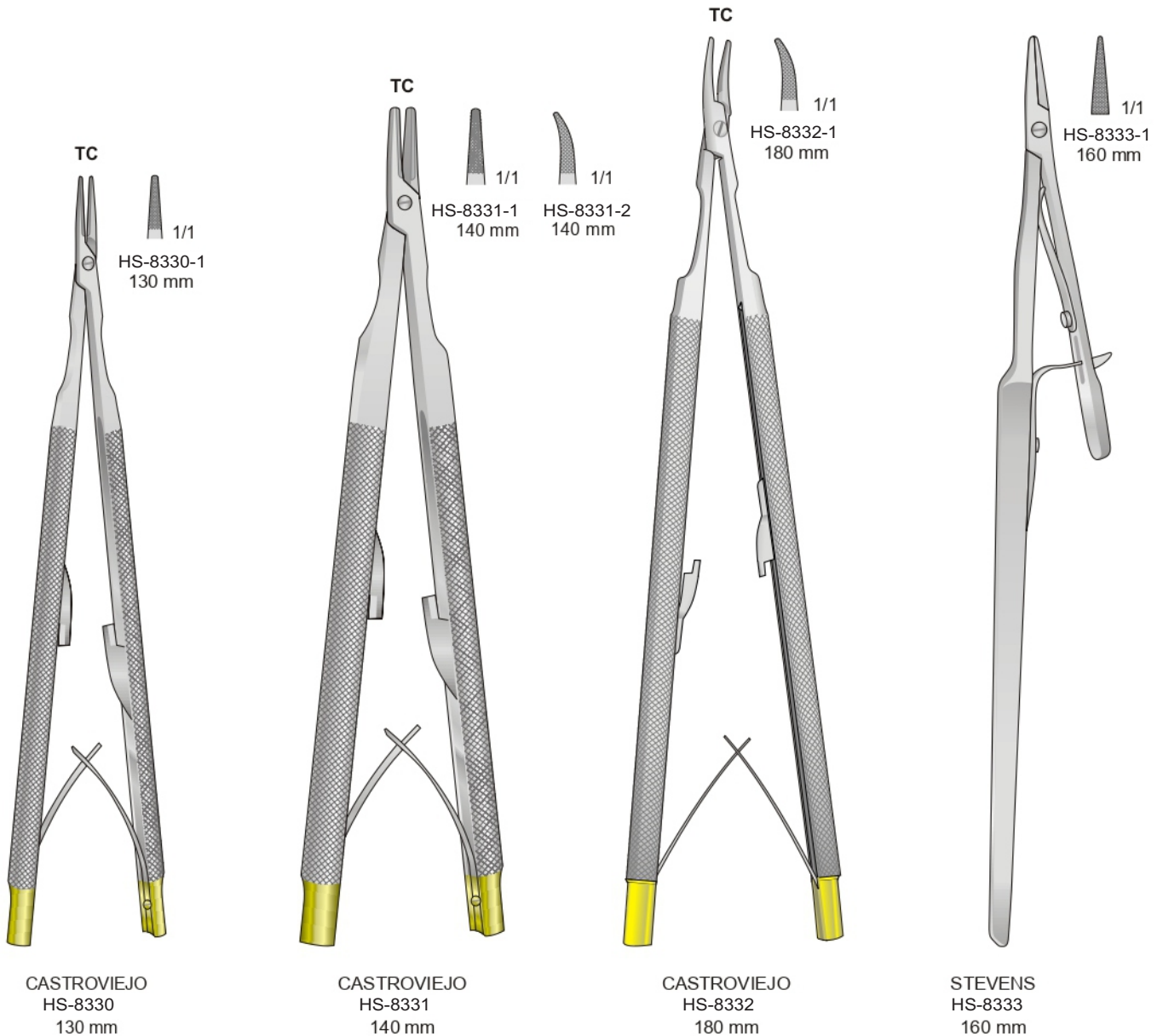

Con morso liscio
 With smooth jaws
 Mit Glatten maul
 Avec mors lisses
 Con mandibula lisa

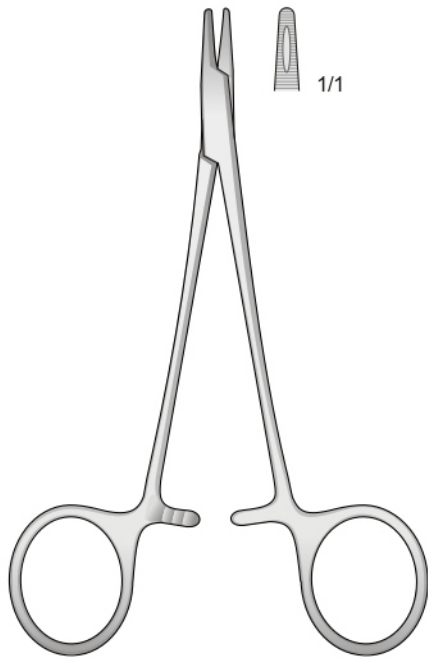

DERF
 HS-8334
 125 mm

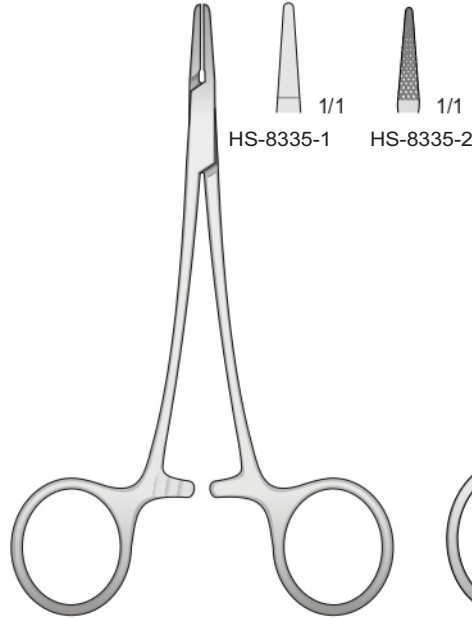

HS-8335
 120 mm

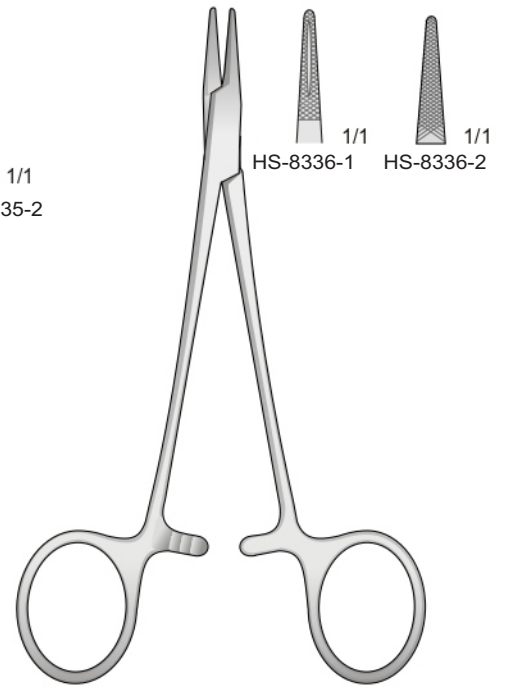

HALSEY
 HS-8336
 130 mm

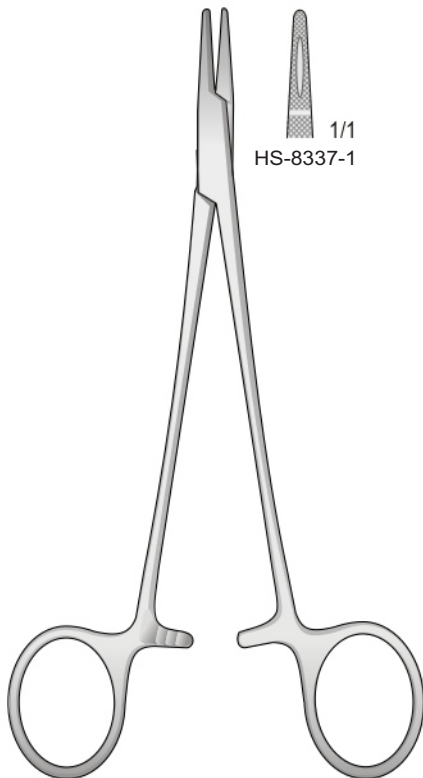

CRILE-WOOD
 HS-8337
 150 mm

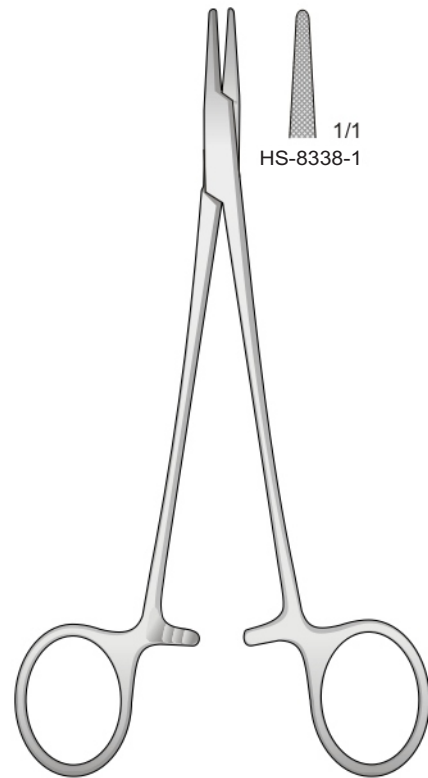

CRILE-MURRAY
 HS-8338
 150 mm



Needle Holders

Modello fine - Delicate pattern - Schlankesmodell
Modèle fin - Modelo delegado

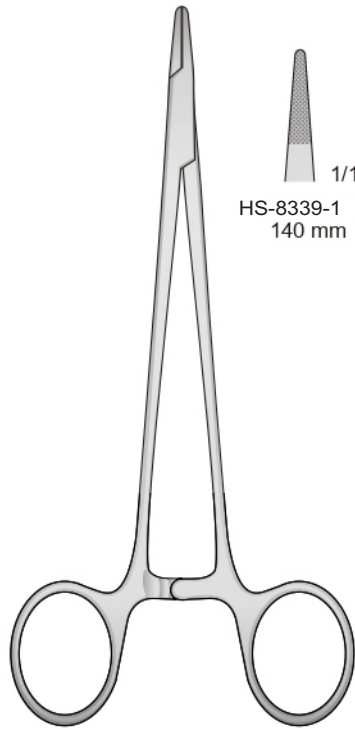

MAYO-HEGAR
HS-8339

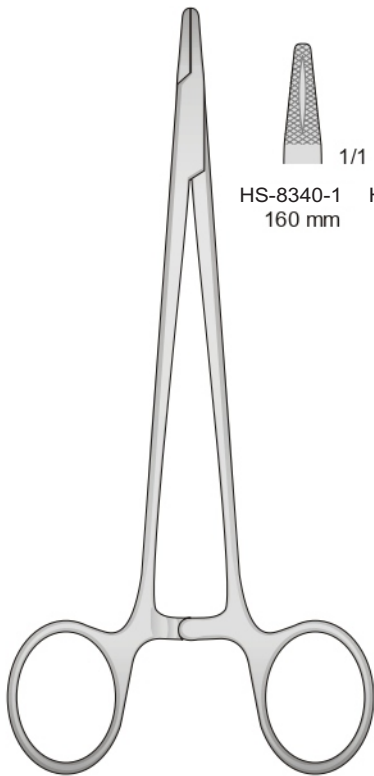
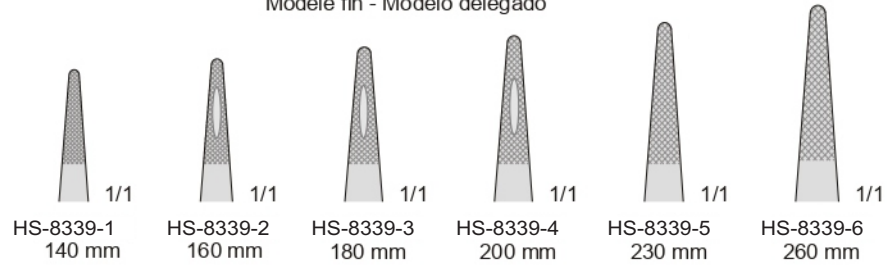

HEGAR
HS-8340

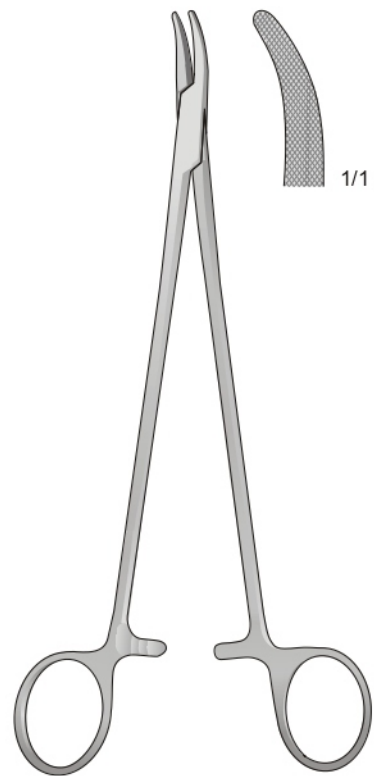
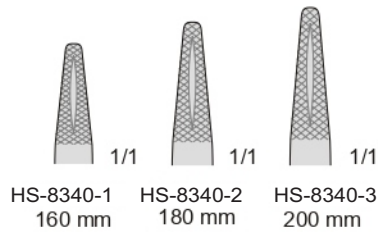

HEANEY (HEGAR)
HS-8341
200 mm

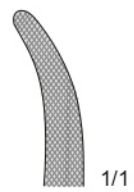

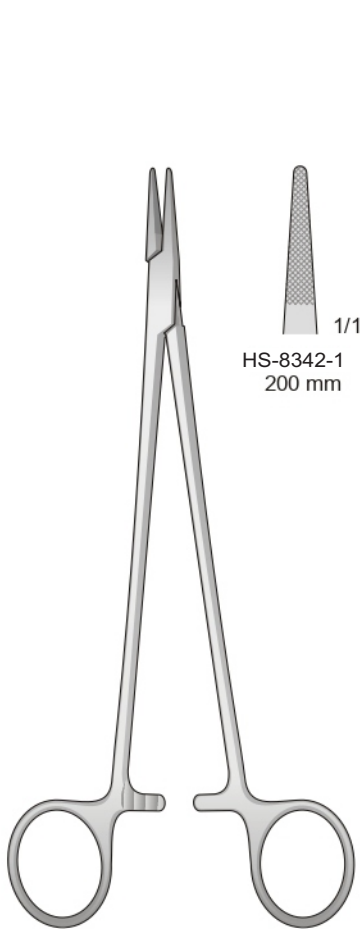

HEGAR-MAYO-SEELEY
HS-8342
200 mm

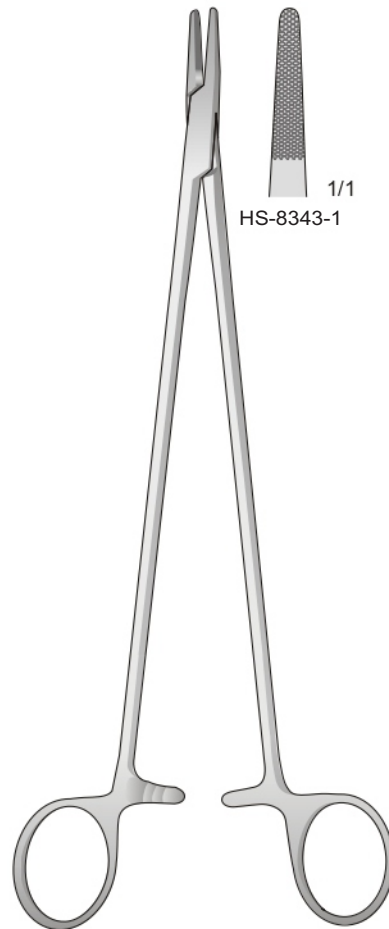

MASSON
HS-8343
270 mm

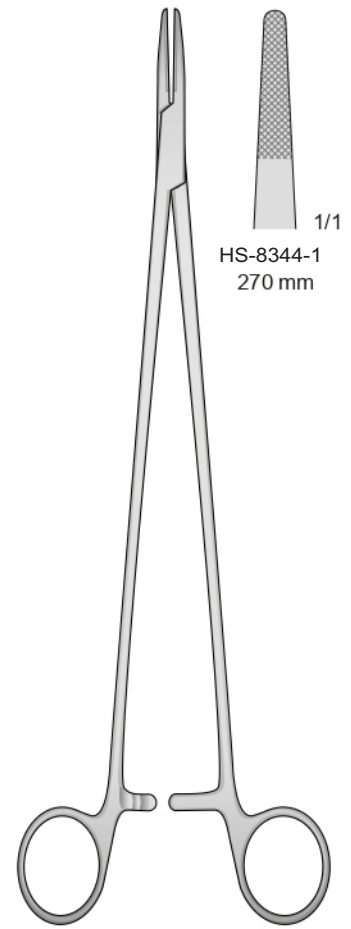

WANGENSTEEN
HS-8344
270 mm



Port'aghi con forbici - Needle holders with scissors - Nadelhalter mit Schere - Porte aiguilles avec ciseaux - Portaaguja con tijeras

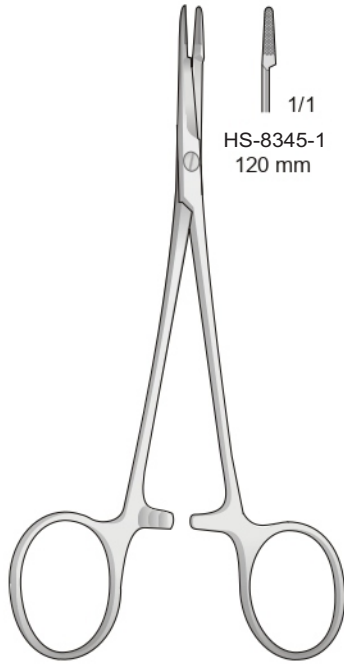

MINI-OLSEN-HEGAR
HS-8345
120 mm

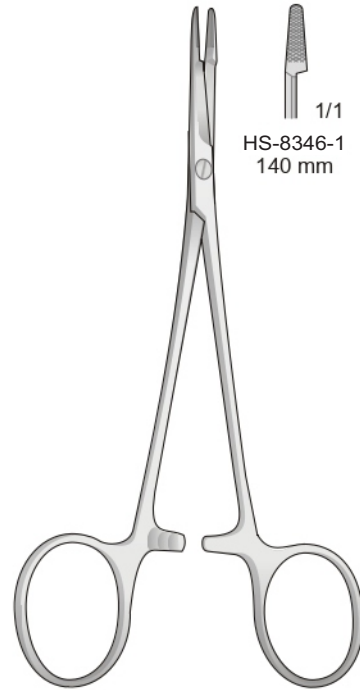

OLSEN-HEGAR
HS-8346
140 mm

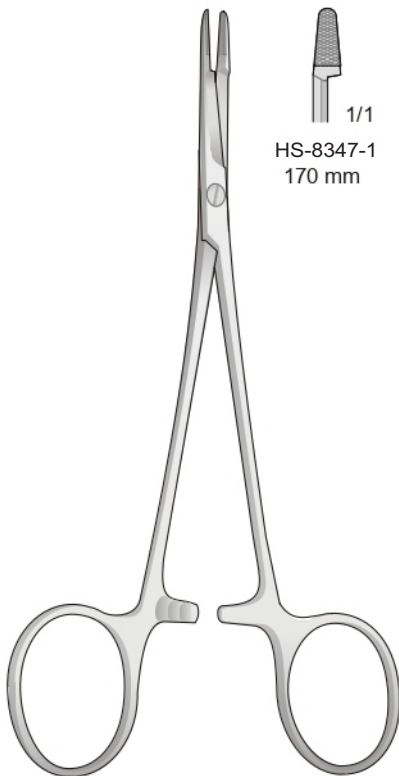

OLSEN-HEGAR
HS-8347
170 mm

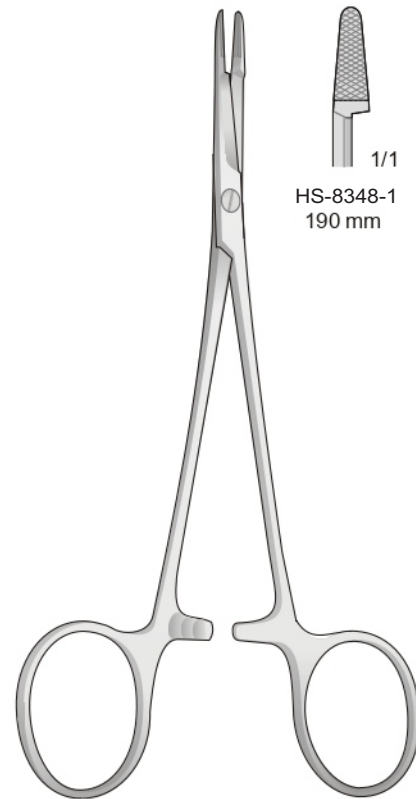

OLSEN-HEGAR
HS-8348
190 mm



Needle Holders

Port'aghi con forbici - Needle holders with scissors - Nadelhalter mit Schere - Porte aiguilles avec ciseaux - Portaagujas con tijeras

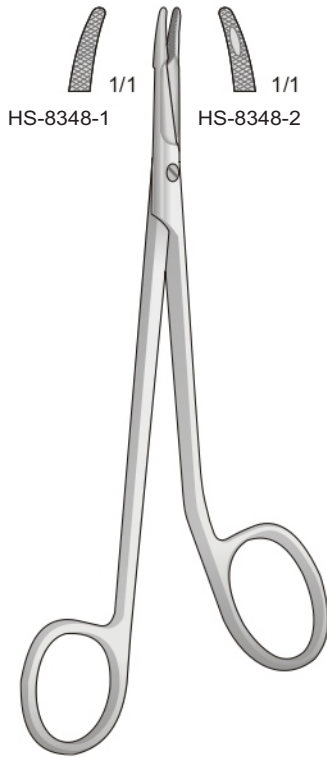

MINI-GILLIES
HS-8348
145 mm

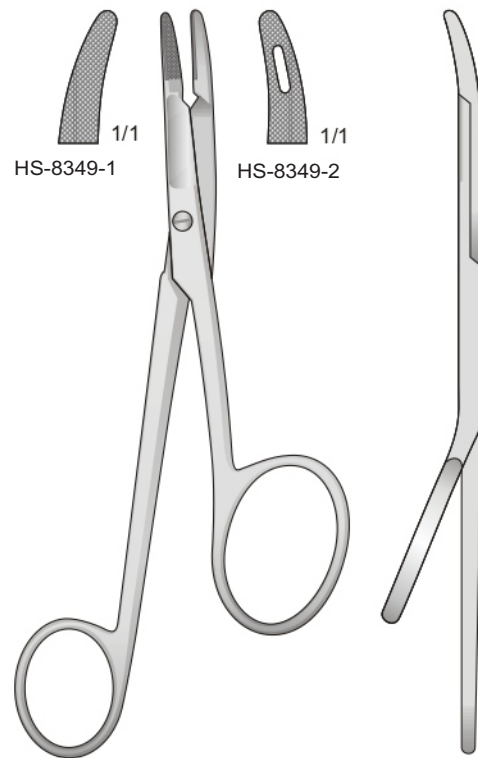

GILLIES
HS-8349
160 mm

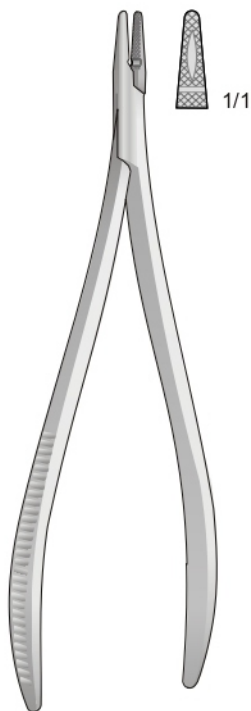

CRILE
HS-8350
150 mm

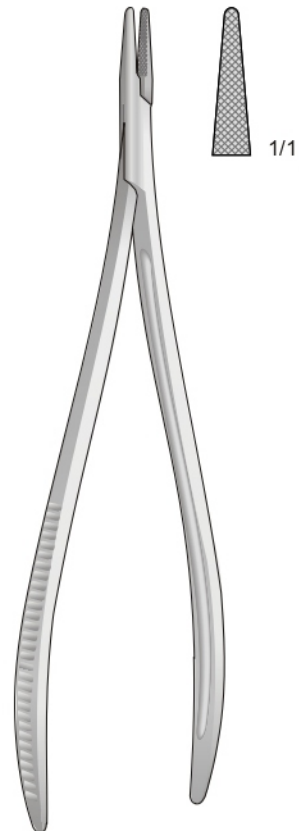

TÖNNIS
HS-8351
190 mm



Needle Holders

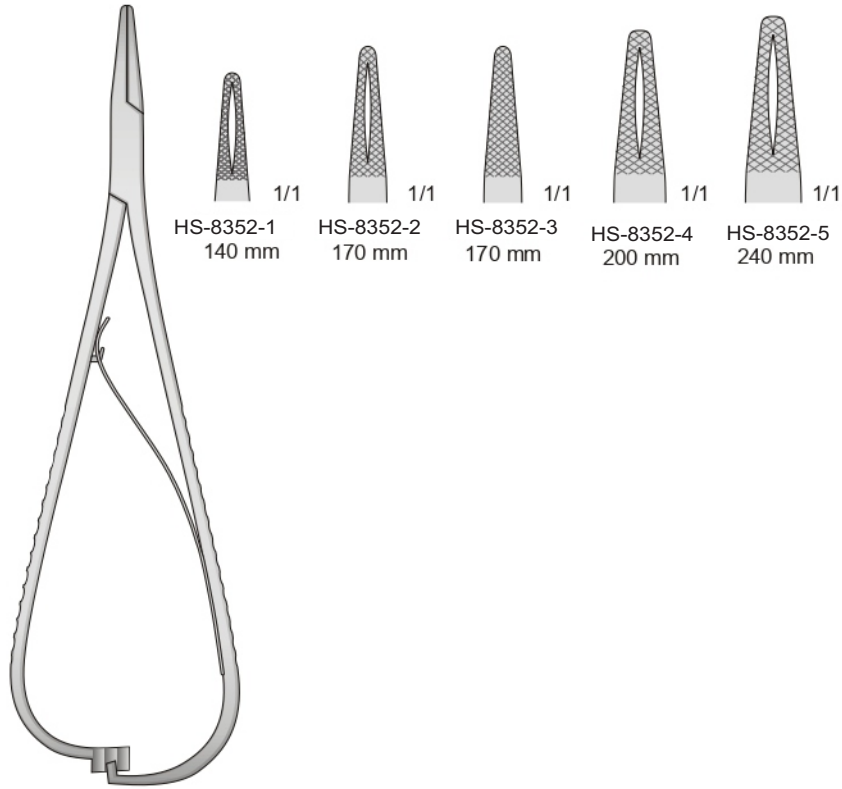

MATHIEU
HS-8352

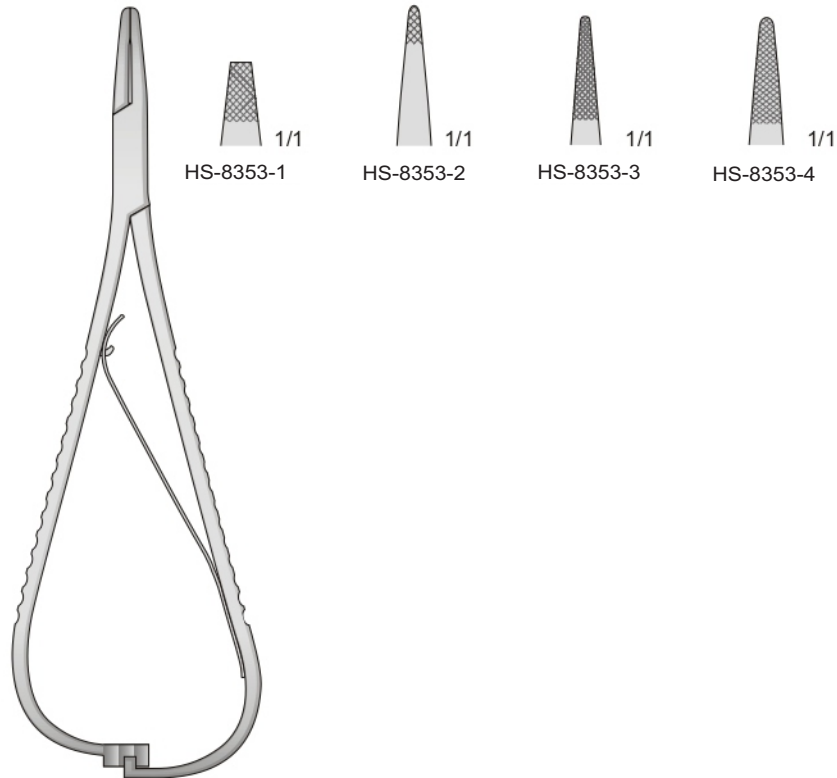

MATHIEU
HS-8353
140 mm

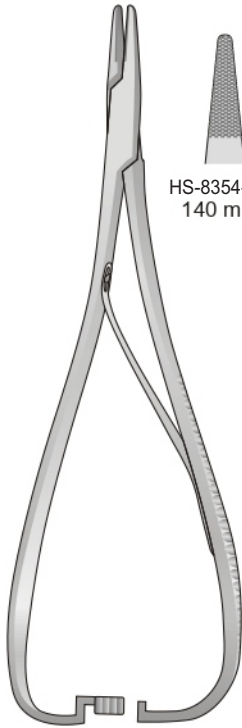

MATHIEU
HS-8354

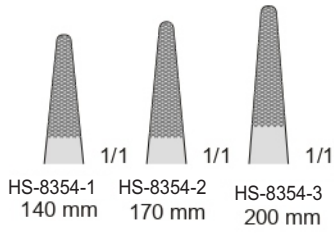

HS-8355
140 mm

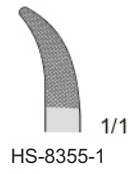

STILLE
HS-8356
170 mm

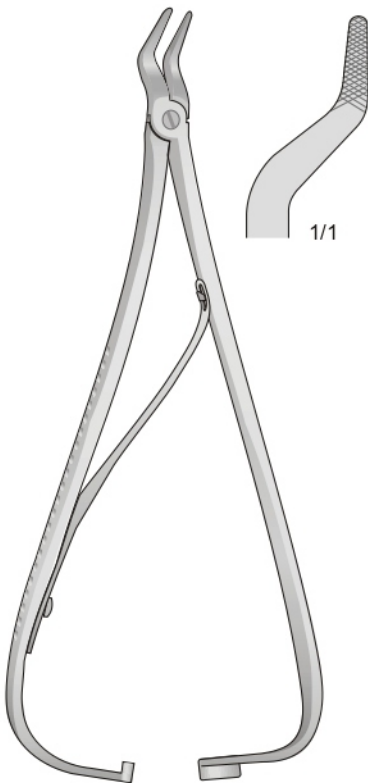
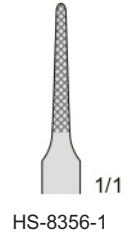

EISELBERG-MATHIEU
HS-8357
180 mm

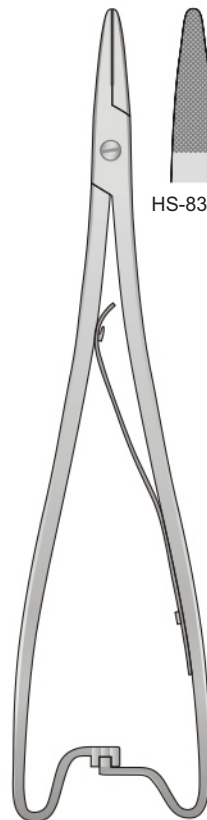
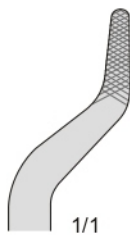

MATHIEU
HS-8358
200 mm

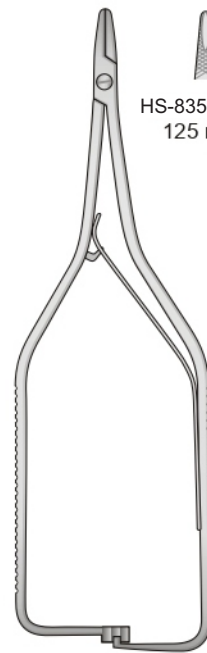
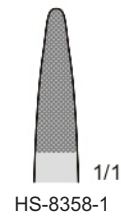

BOYNTON
HS-8359
125 mm

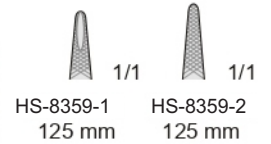

Portaghi con inserti al tungsteno - Needle Holders with tungsten-carbide inserts
Nadelhalter mit Hartmetalleinlagen - Porte aiguilles avec plaquettes en carbure de tungstène
Portaagujas con plaquitas de carburo de tungsteno

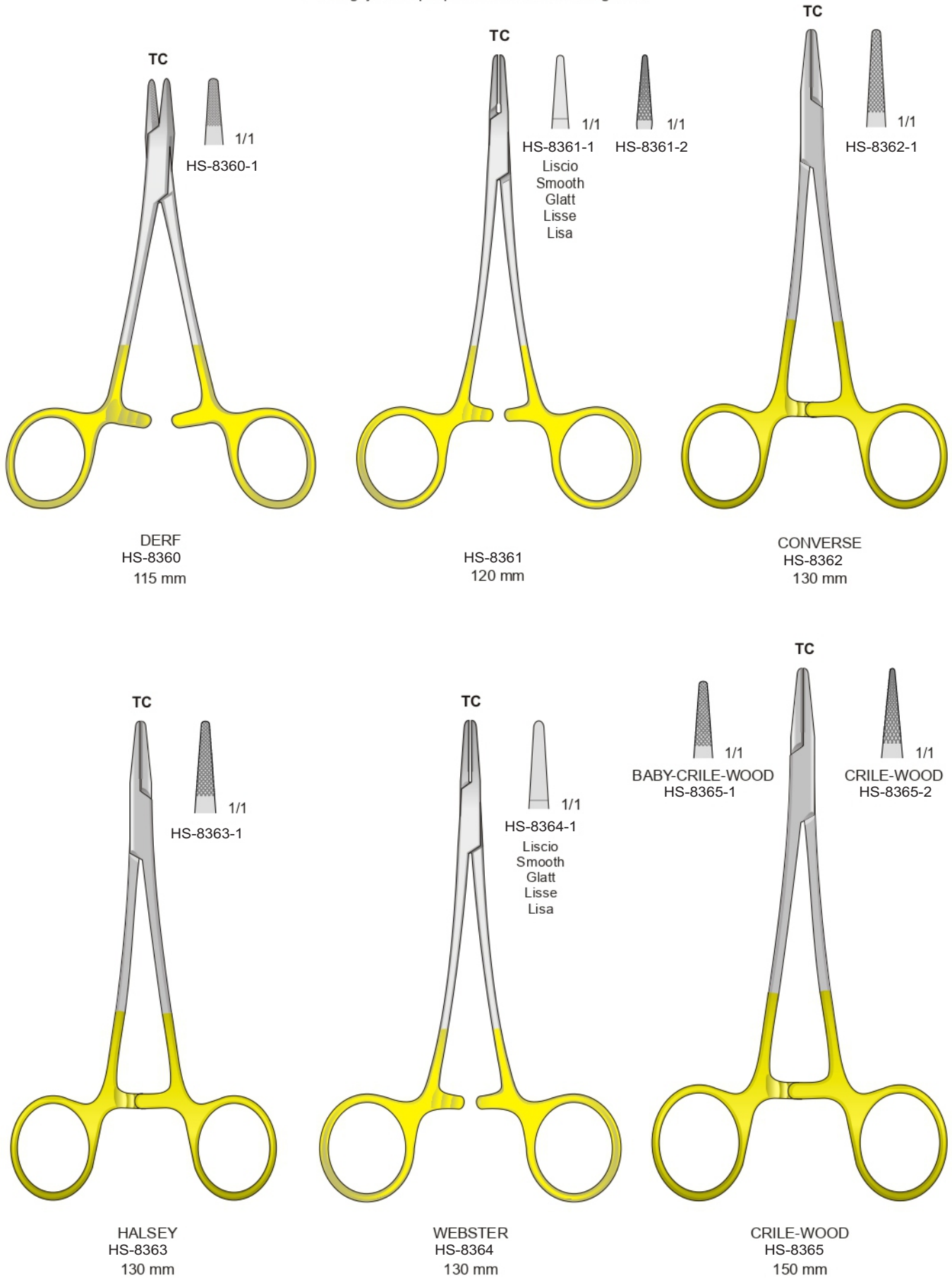



Needle Holders

Portaghi con inserti al tungsteno - Needle Holders with tungsten-carbide inserts
Nadelhalter mit Hartmetalleinlagen - Porte aiguilles avec plaquettes en carbure de tungstène
Portaagujas con plaquitas de carburo de tungsteno

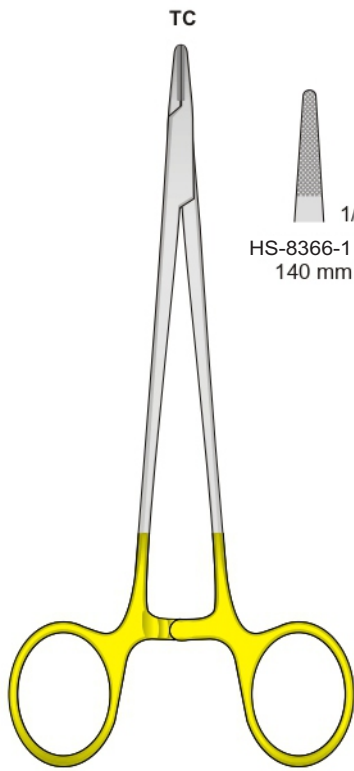

MAYO-HEGAR
HS-8366

TC

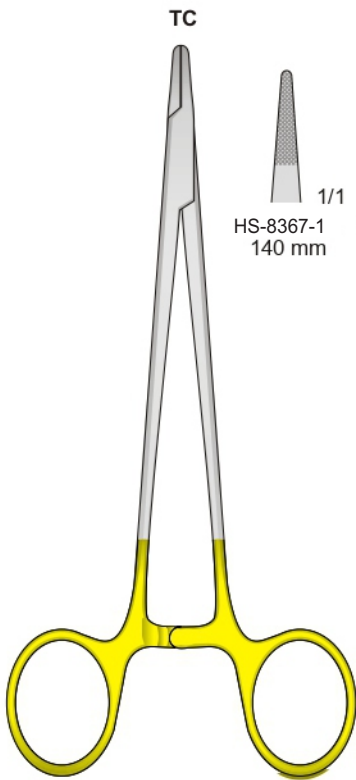
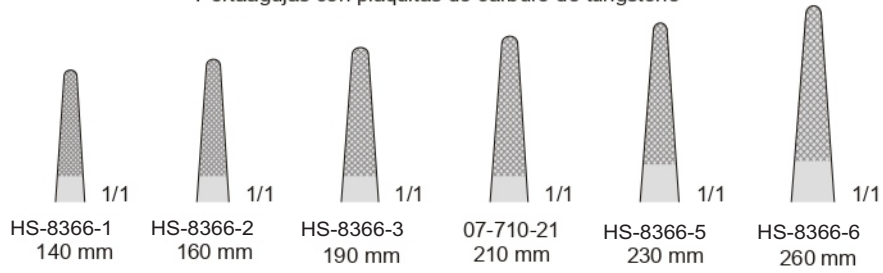

HS-8367
07-720

TC

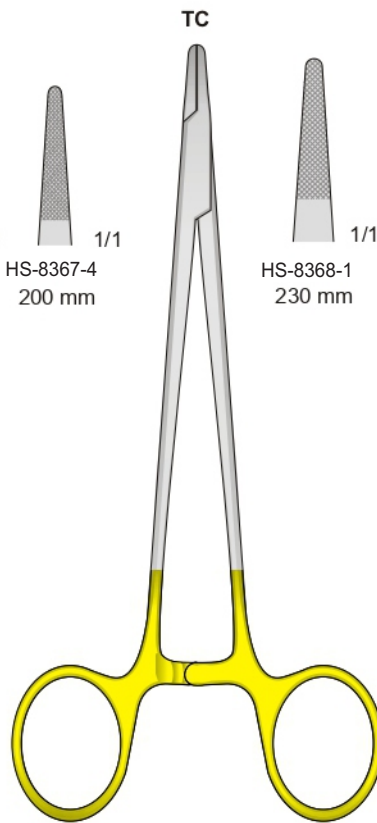
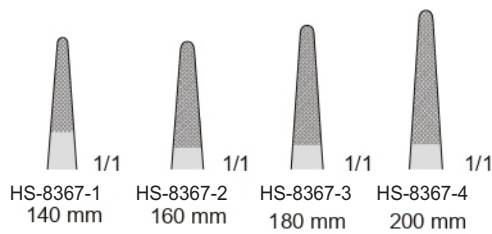

MAYO-HEGAR
HS-8368

TC

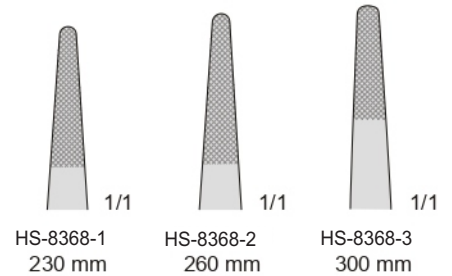

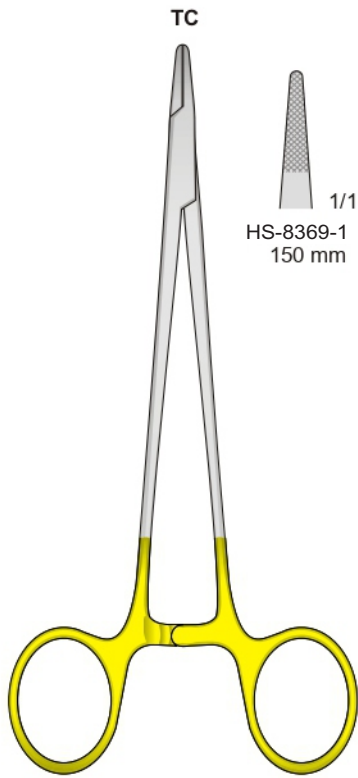

MAYO-HEGAR-FINO
HS-8369

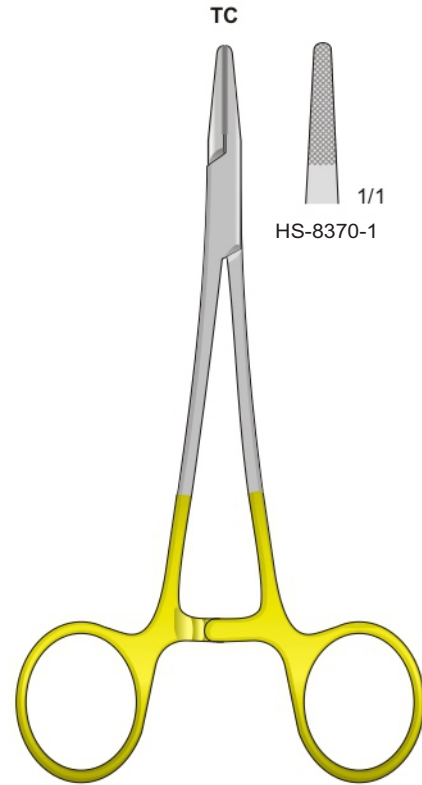

CRILE-WOOD
HS-8370
180 mm

Port'aghi, pinze per fili d'acciaio
Needle holder, wire forceps
Nadelhalter, Draht-Zangen
Porte-aiguilles, pinces à saisir
Porta agujas, pinzas para hilos

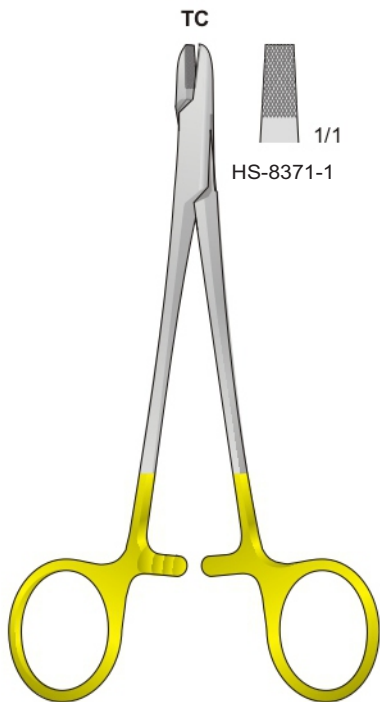

HS-8371
150 mm

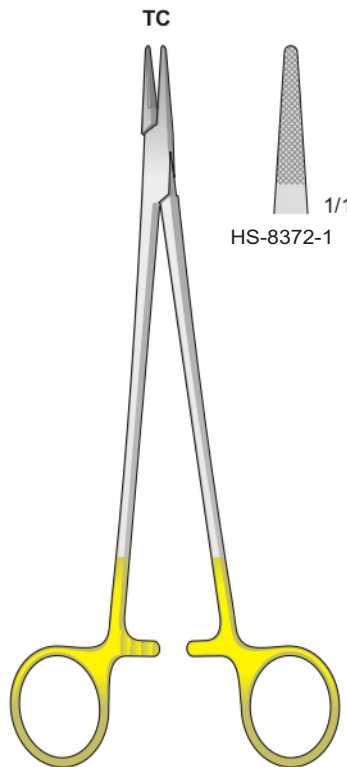

HEGAR-MAYO-SEELEY
HS-8372
200 mm

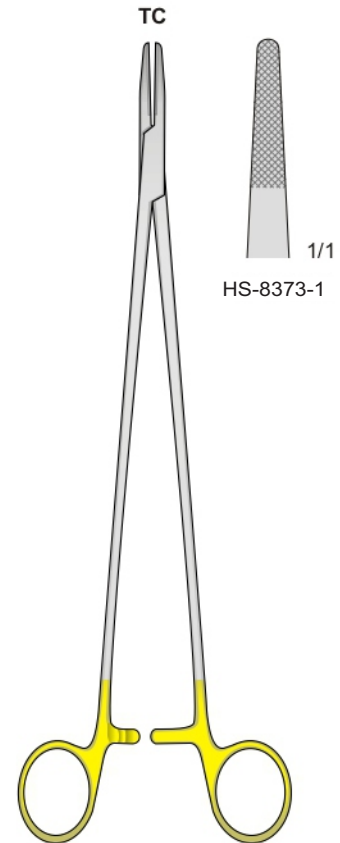

WANGENSTEEN
HS-8373
270 mm



Port'aghi con forbici - Needle holders with scissors - Nadelhalter mit Schere - Porte aiguilles avec ciseaux - Portaagujas con tijeras

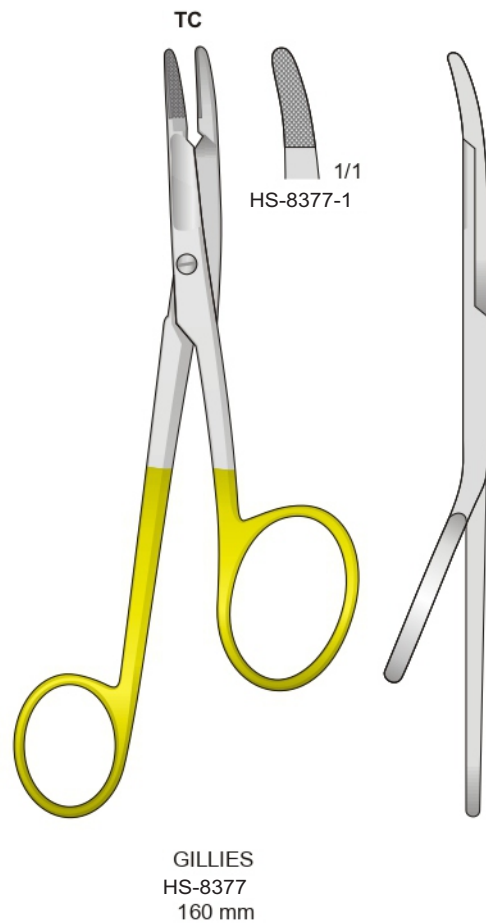
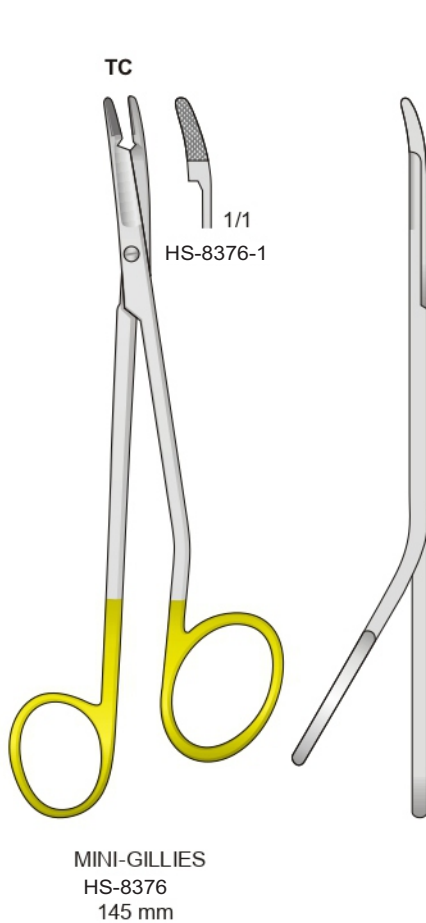
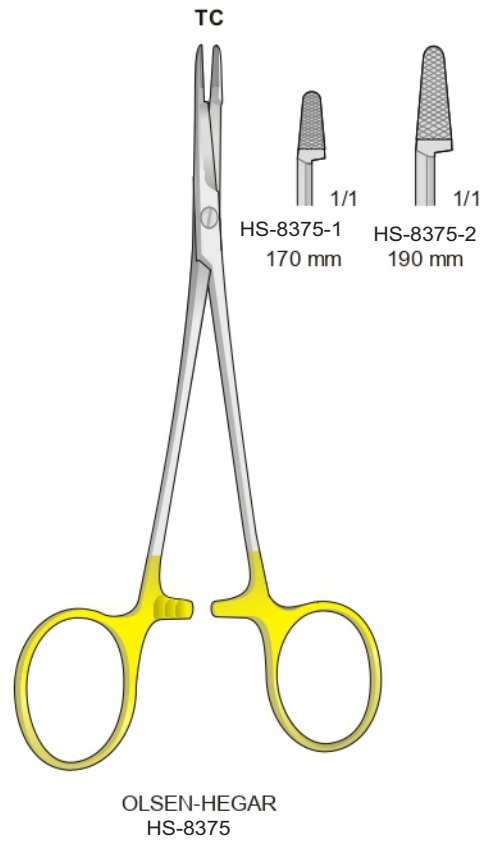
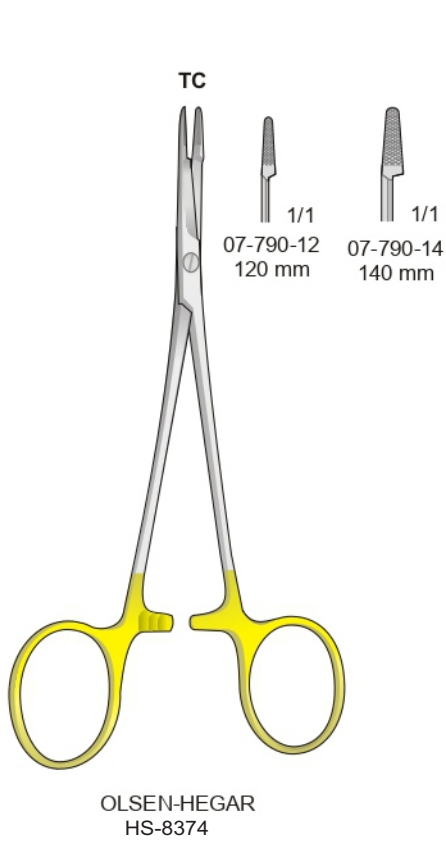



Portaghi con inserti al tungsteno - Needle Holders with tungsten-carbide inserts
Nadelhalter mit Hartmetalleinlagen - Porte aiguilles avec plaquettes en carbure de tungstène
Portaagujas con plaquitas de carburo de tungsteno

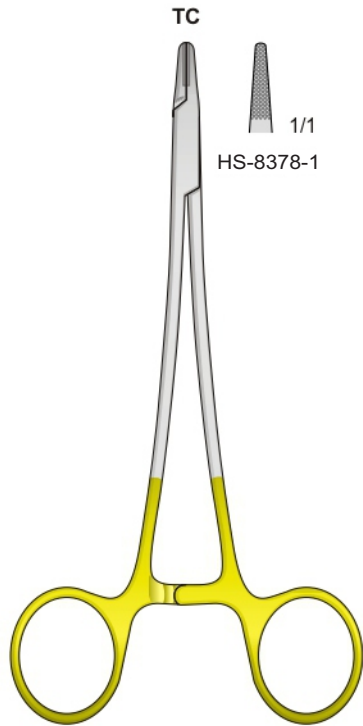

HS-8378
145 mm

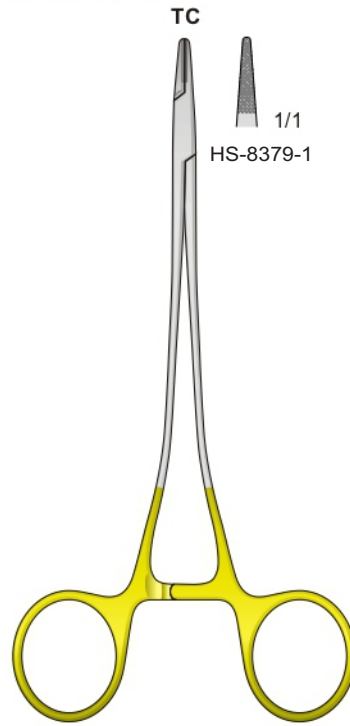

HS-8379
150 mm

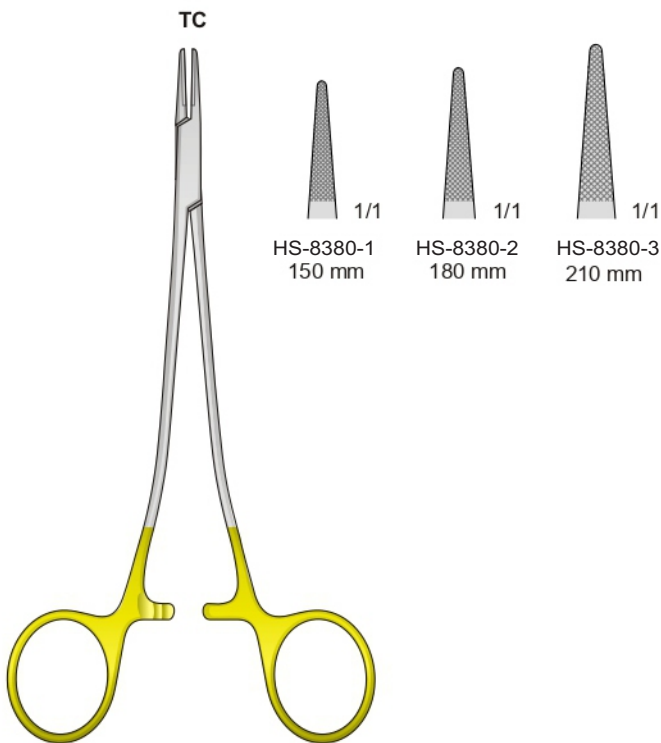

SAROT
HS-8380

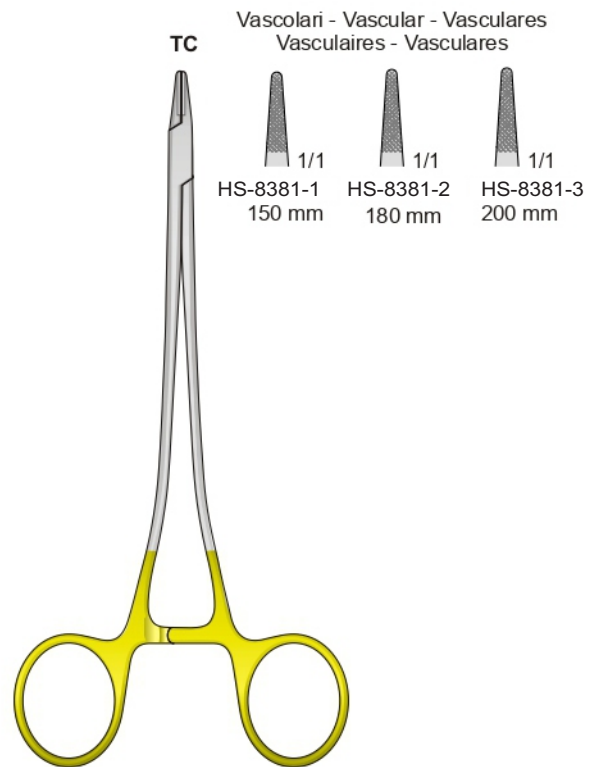

SWEDESH MOD.
HS-8381

Needle Holders

Portaghi con inserti al tungsteno - Needle Holders with tungsten-carbide inserts
 Nadelhalter mit Hartmetalleinlagen - Porte aiguilles avec plaquettes en carbure de tungstène
 Portaagujas con plaquitas de carburo de tungsteno

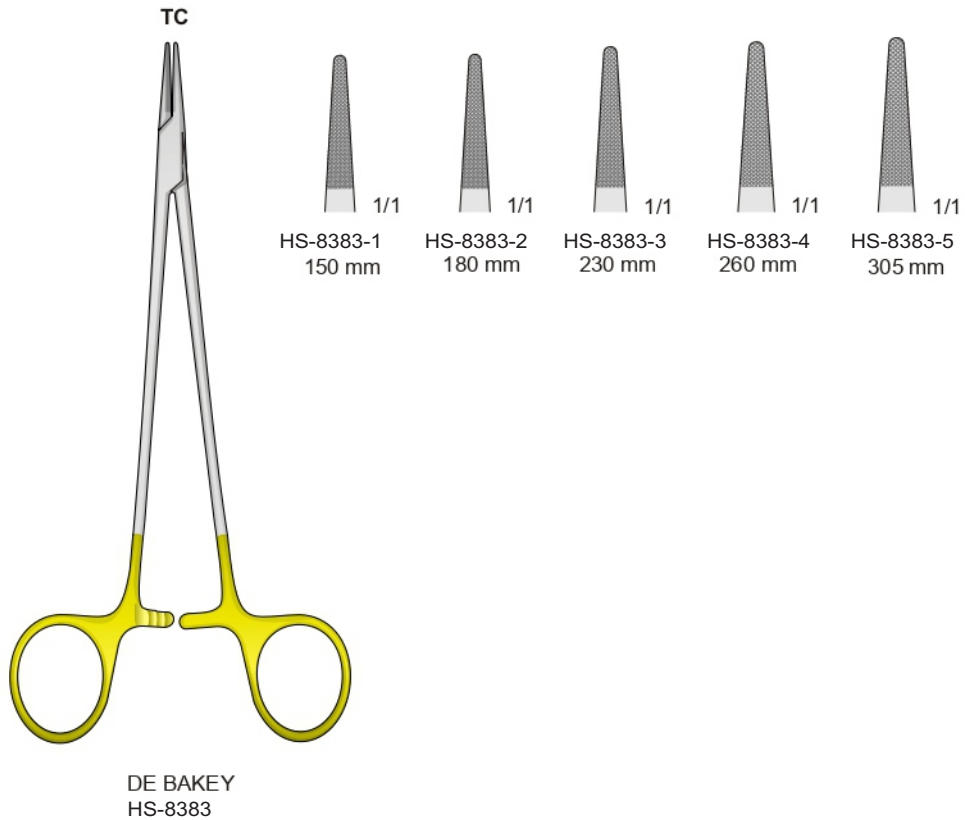
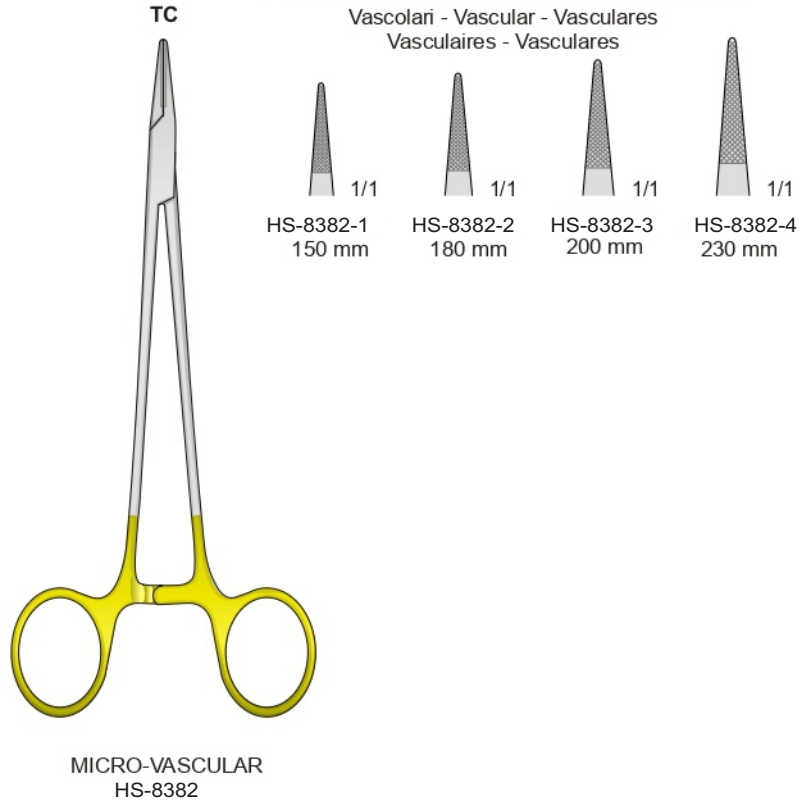

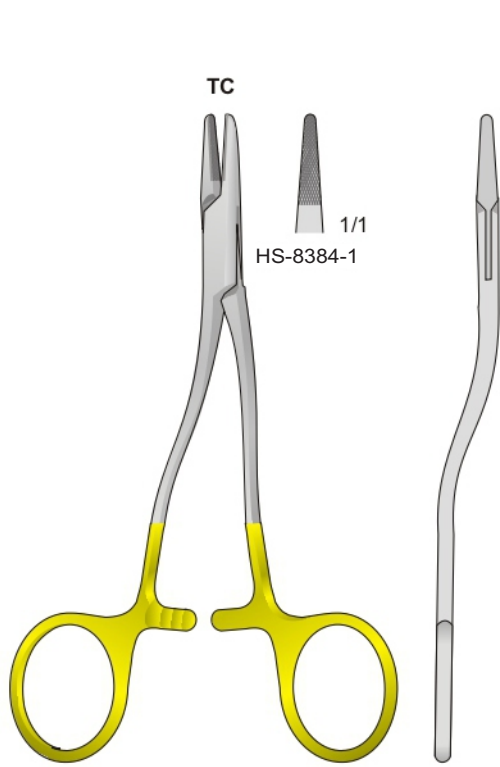

KILNER
HS-8384
130 mm

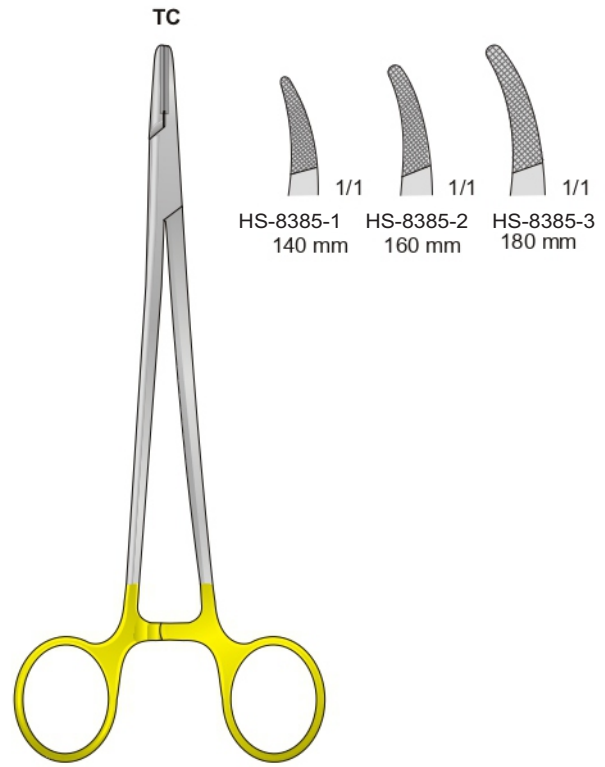

MAYO-HEGAR-HEANEY
HS-8385

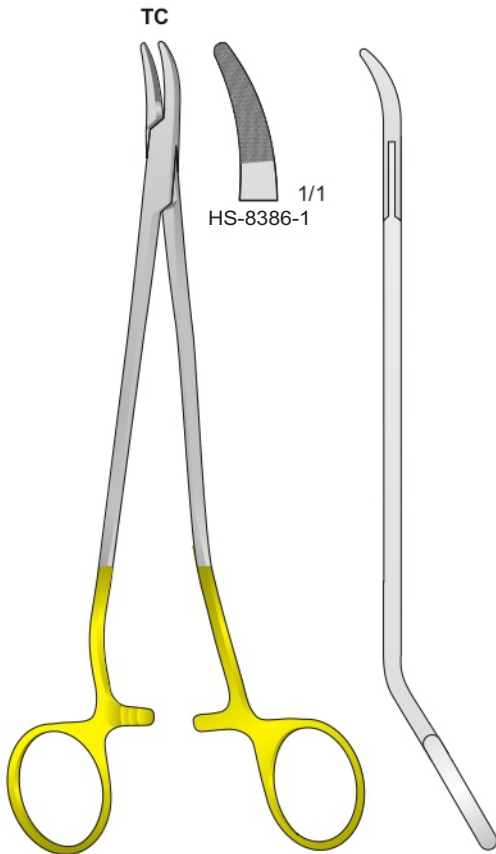

S-FORMING
HS-8386
200 mm

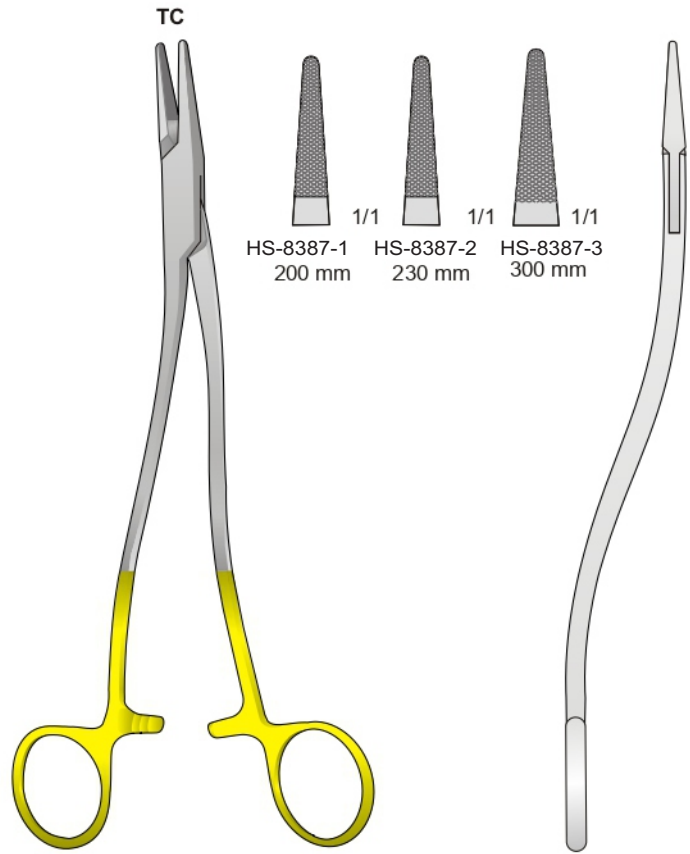

WERTHEIM
HS-8387



Portaghi con inserti al tungsteno - Needle Holders with tungsten-carbide inserts
Nadelhalter mit Hartmetalleinlagen - Porte aiguilles avec plaquettes en carbure de tungstène
Portaagujas con plaquitas de carburo de tungsteno

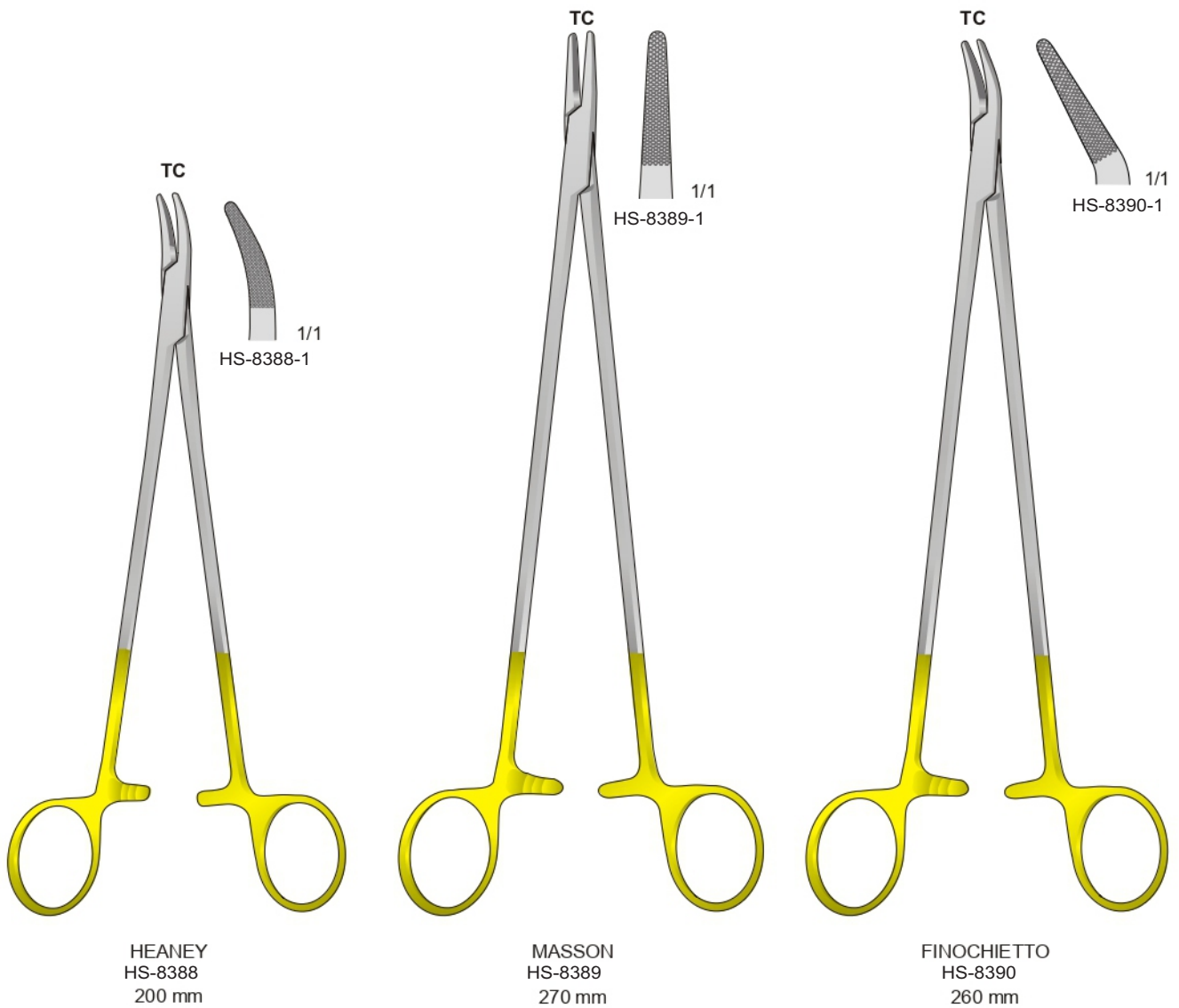

Portaghi con inserti al tungsteno - Needle Holders with tungsten-carbide inserts
Nadelhalter mit Hartmetalleinlagen - Porte aiguilles avec plaquettes en carbure de tungstène
Portaagujas con plaquitas de carburo de tungsteno

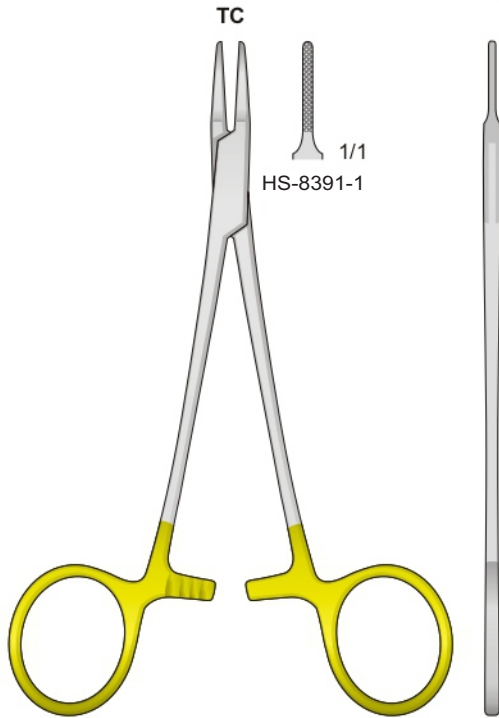

MICRO-RYDER
HS-8391
140 mm

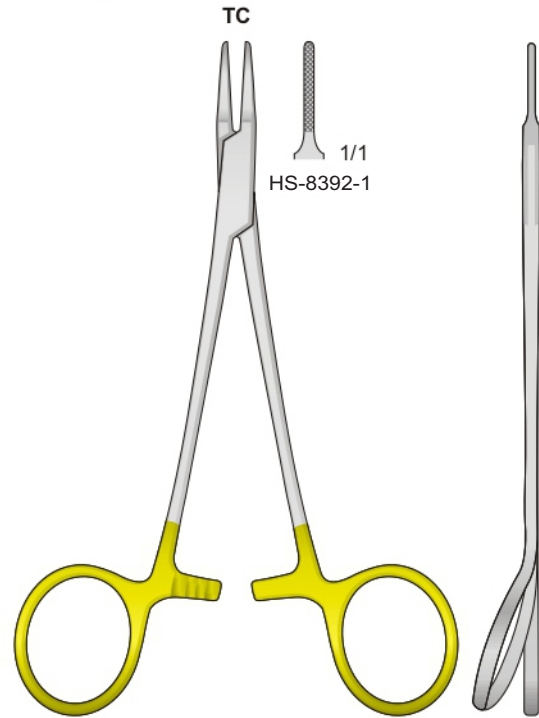

HS-8392
140 mm

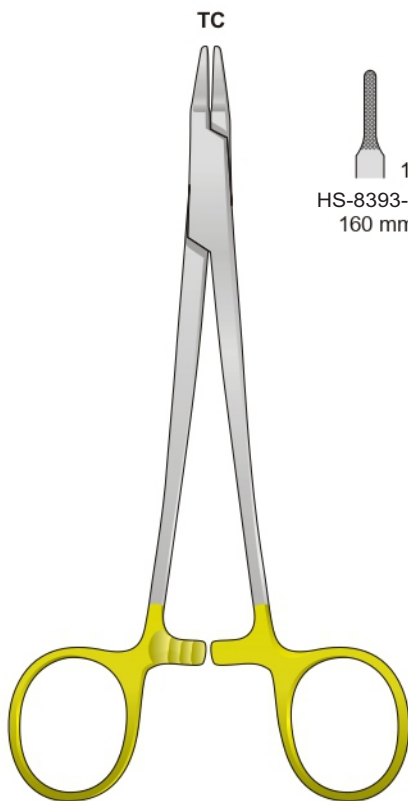

RYDER
HS-8393

TC
HS-8393-1 1/1 160 mm
HS-8393-2 1/1 180 mm
HS-8393-3 1/1 200 mm



Needle Holders

Portaghi con inserti al tungsteno - Needle Holders with tungsten-carbide inserts
Nadelhalter mit Hartmetalleinlagen - Porte aiguilles avec plaquettes en carbure de tungstène
Portaagujas con plaquitas de carburo de tungsteno

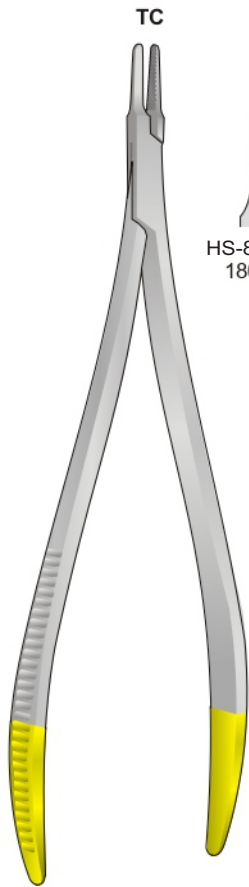

LANGENBECK-RYDER
HS-8394

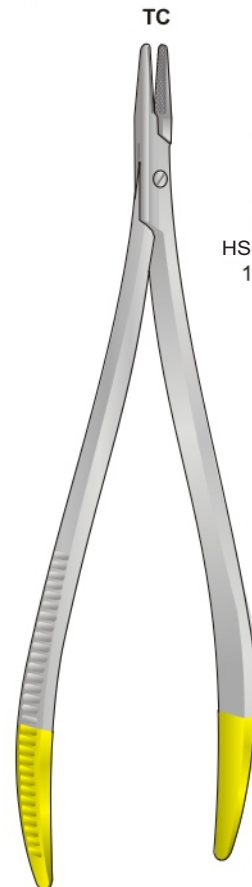
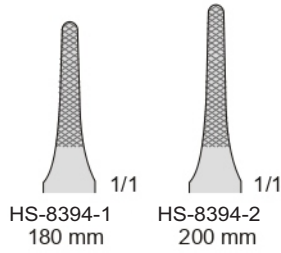

LANGENBECK
HS-8395

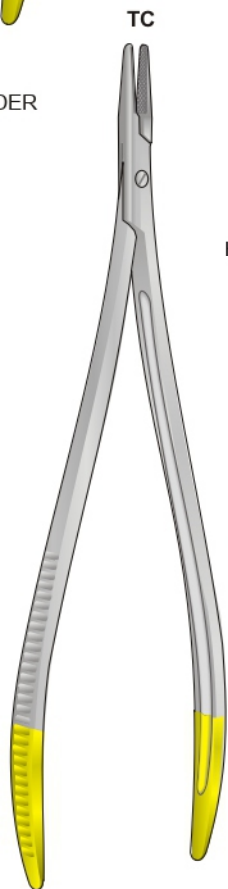
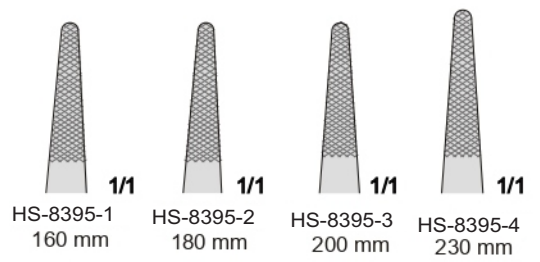

TÖNNIS
HS-8396

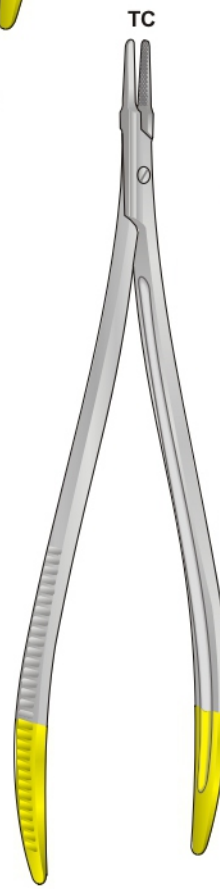
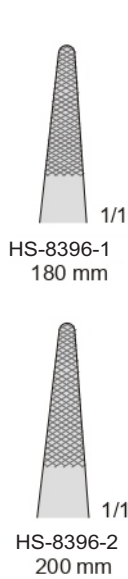

TÖNNIS-RYDER
HS-8397

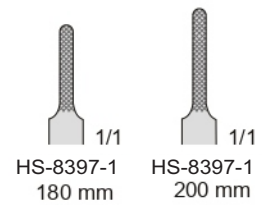

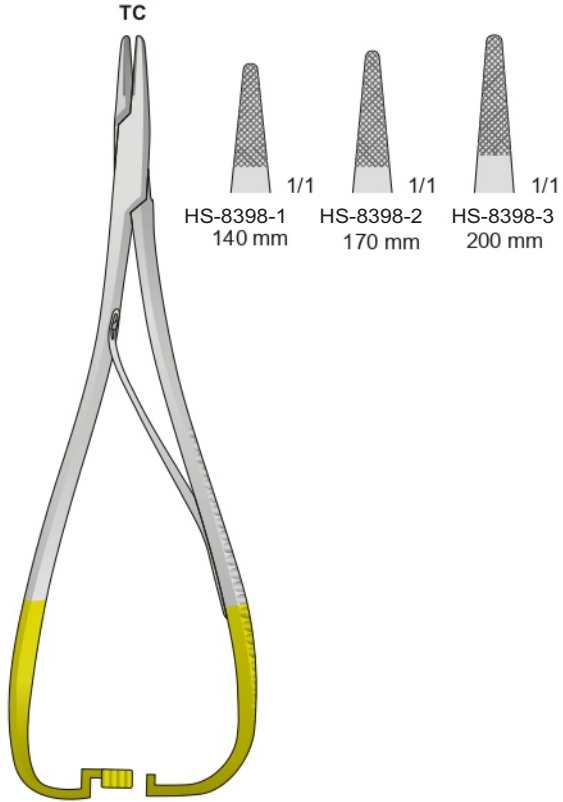

MATHIEU
HS-8398

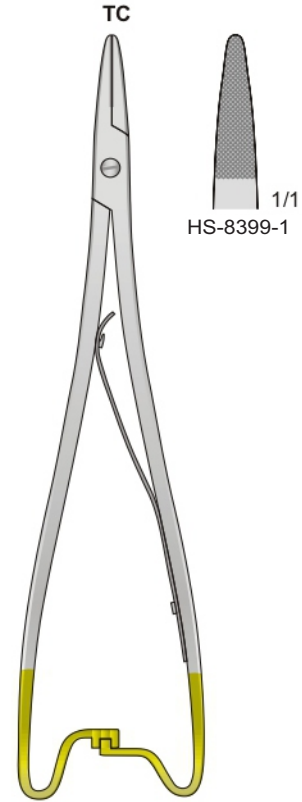

MATHIEU
HS-8399
200 mm

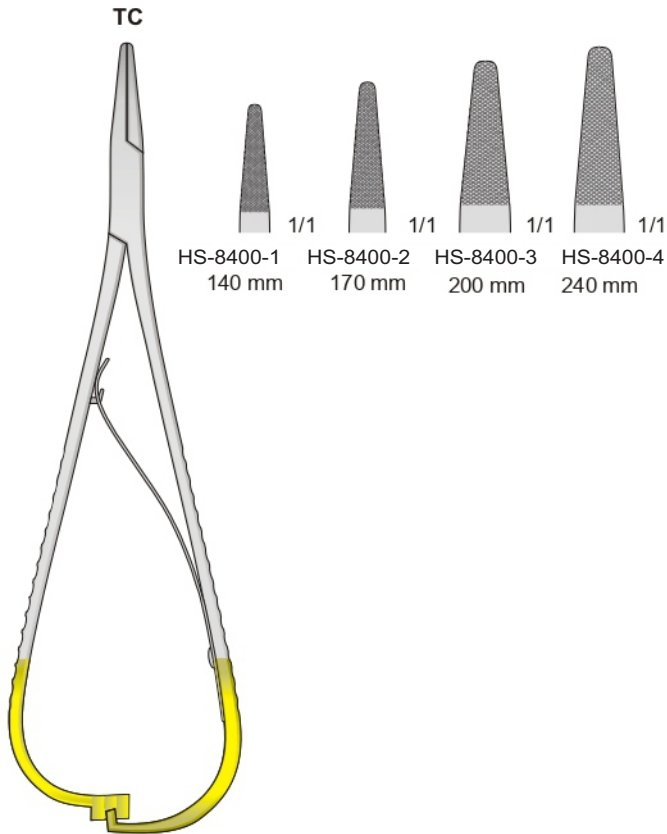

MATHIEU
HS-8400



HS-8401
200 mm

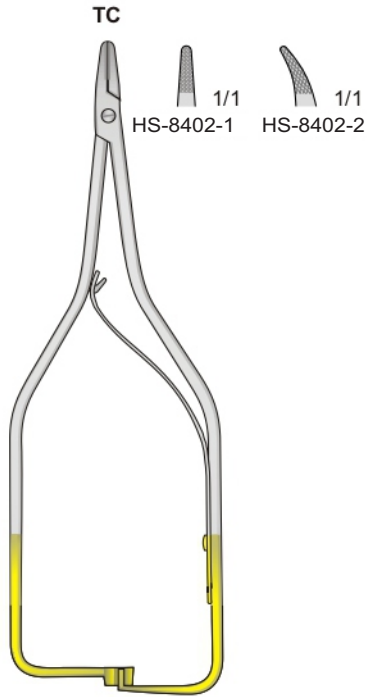

BOYNTON
HS-8402
120 mm

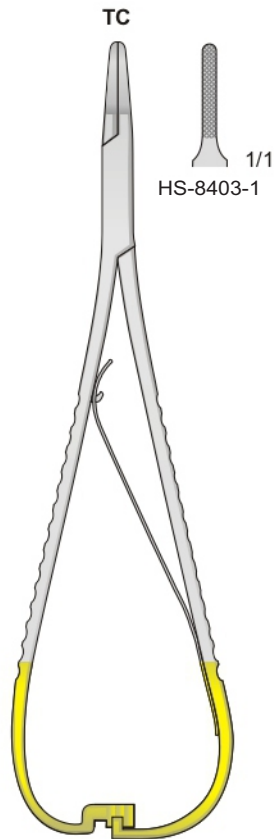

LICHTENBERG
HS-8403
175 mm

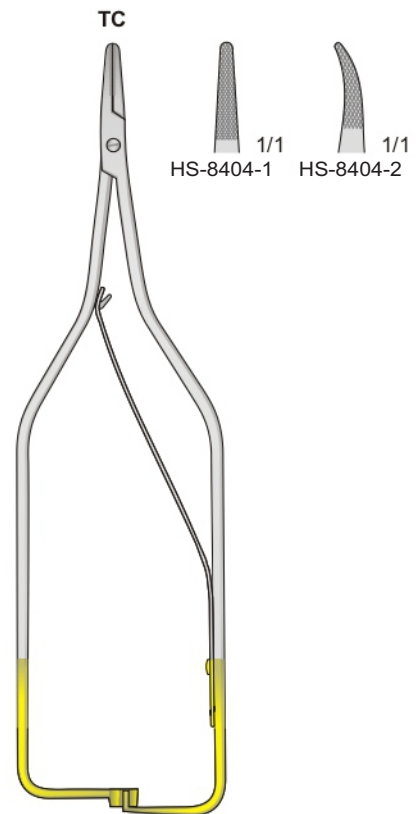

ARRUGA
HS-8404
160 mm



Ligature Needle

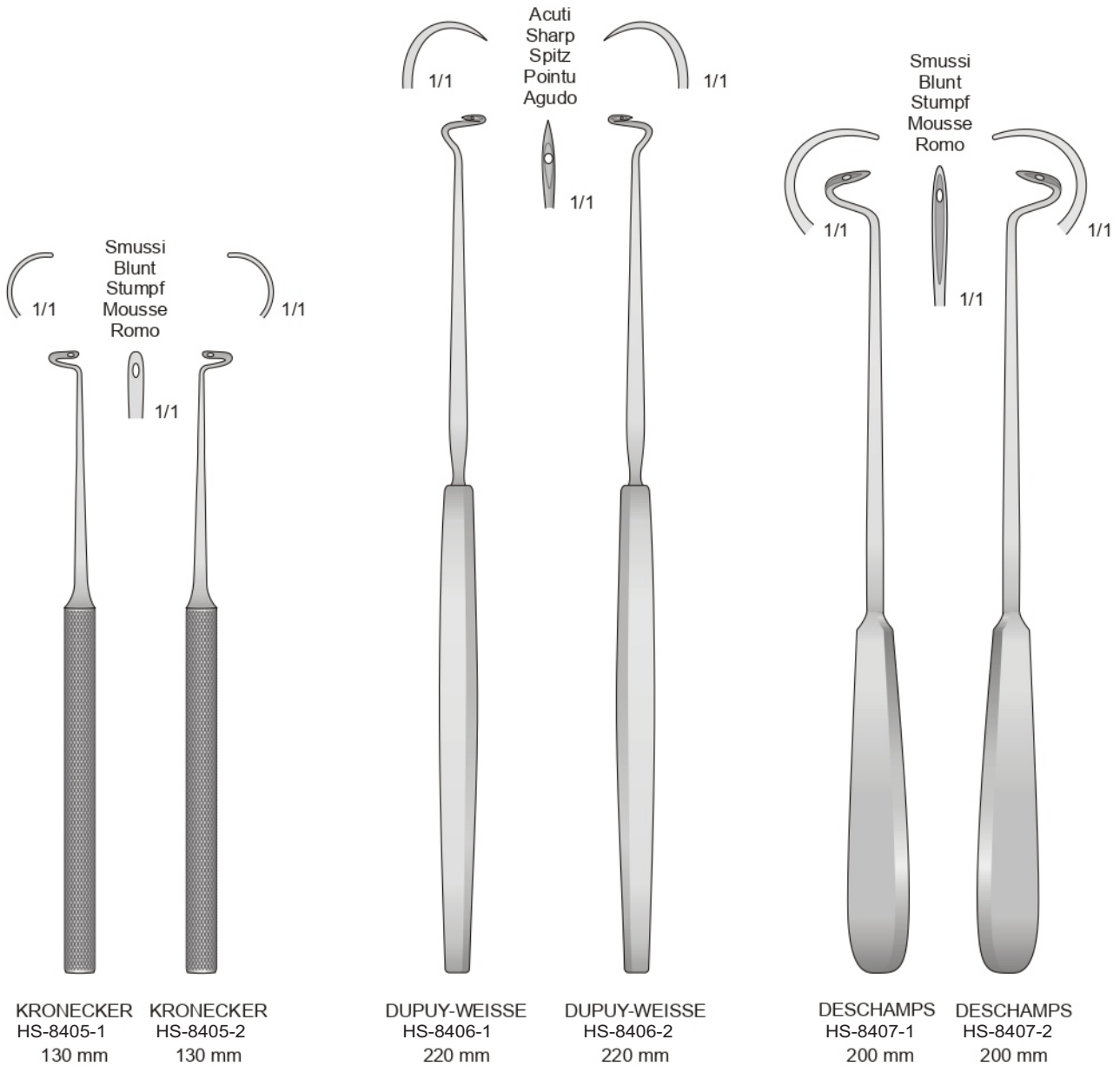

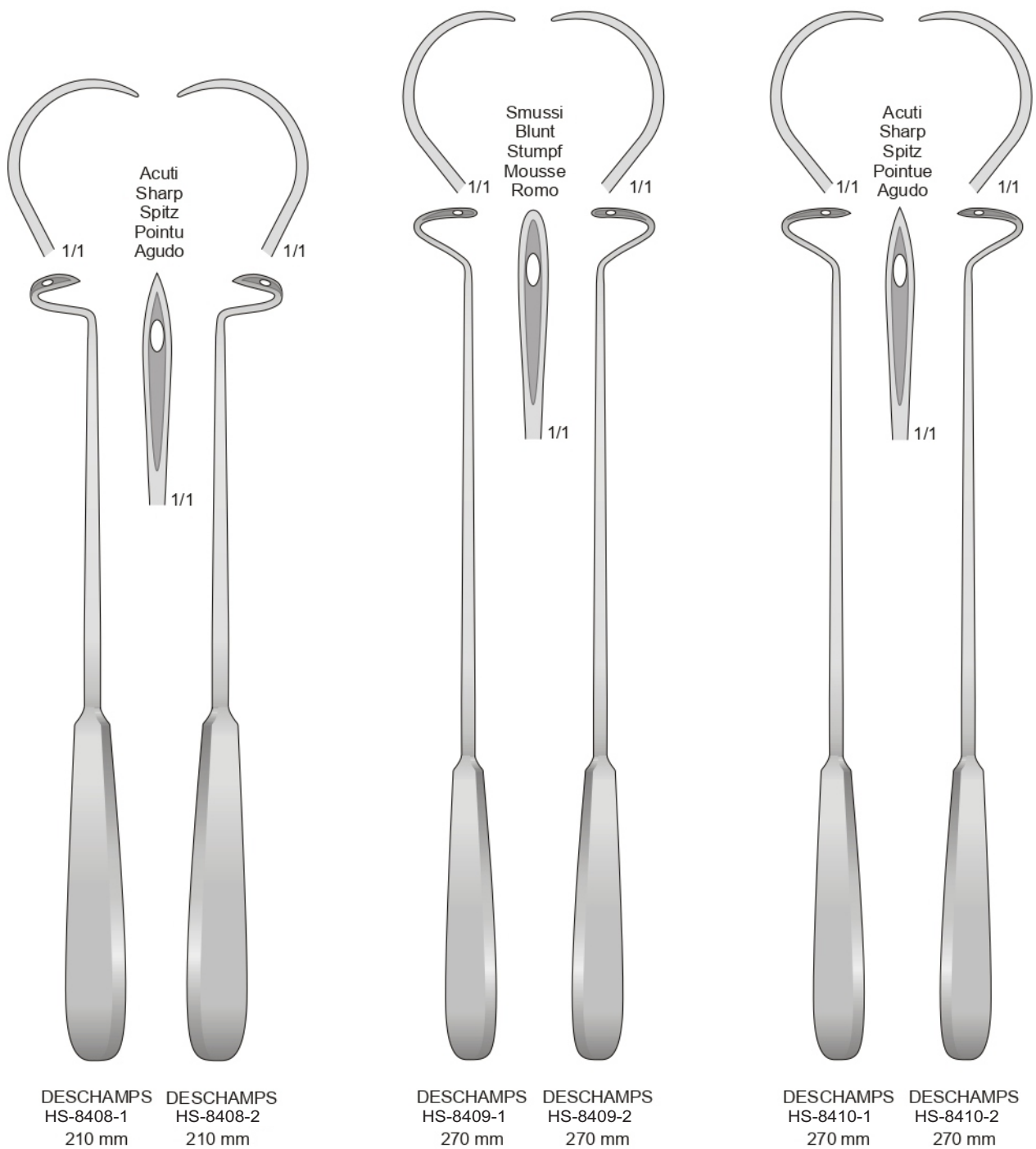

Ligature Needle

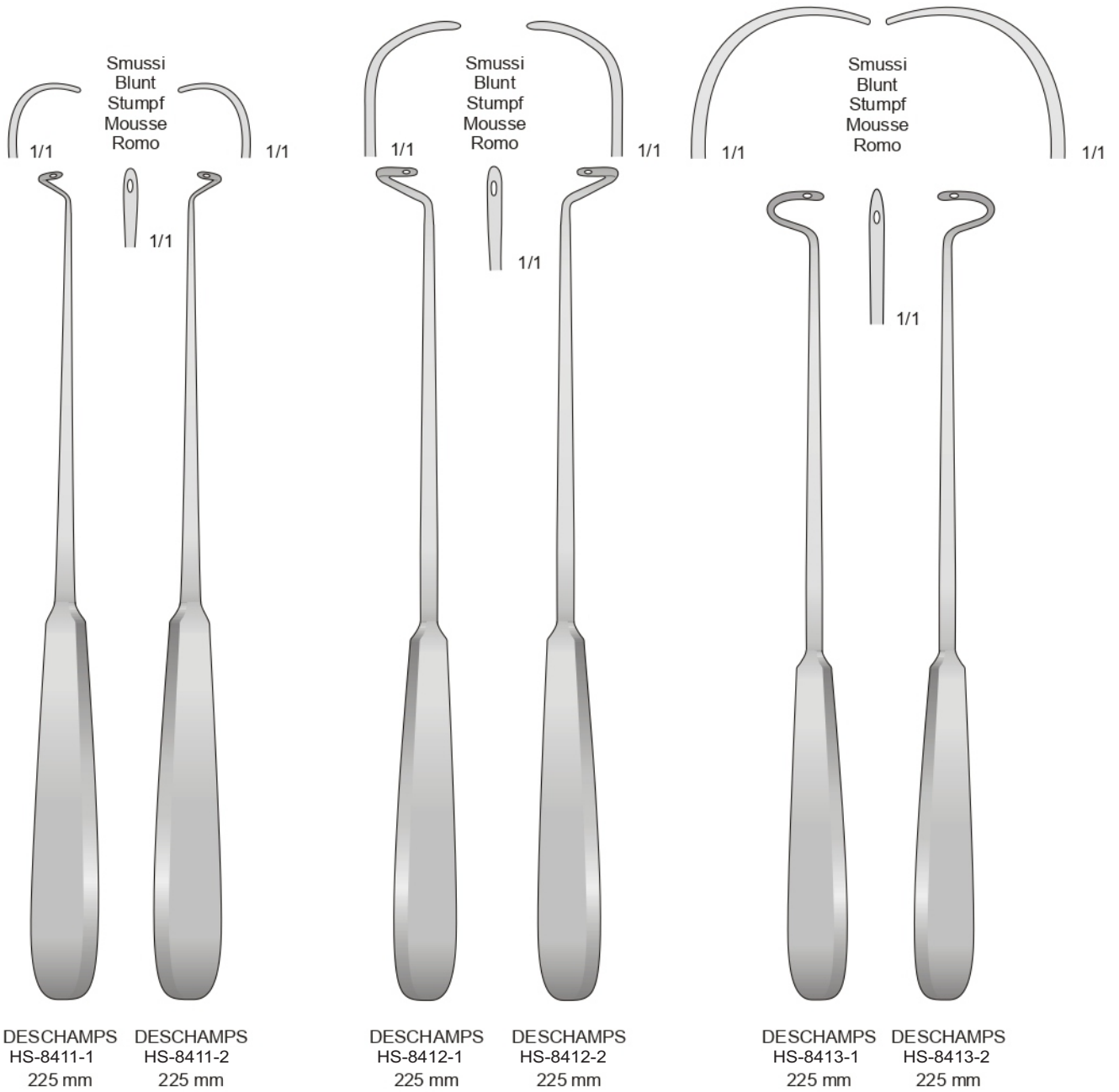



Ligature Needle

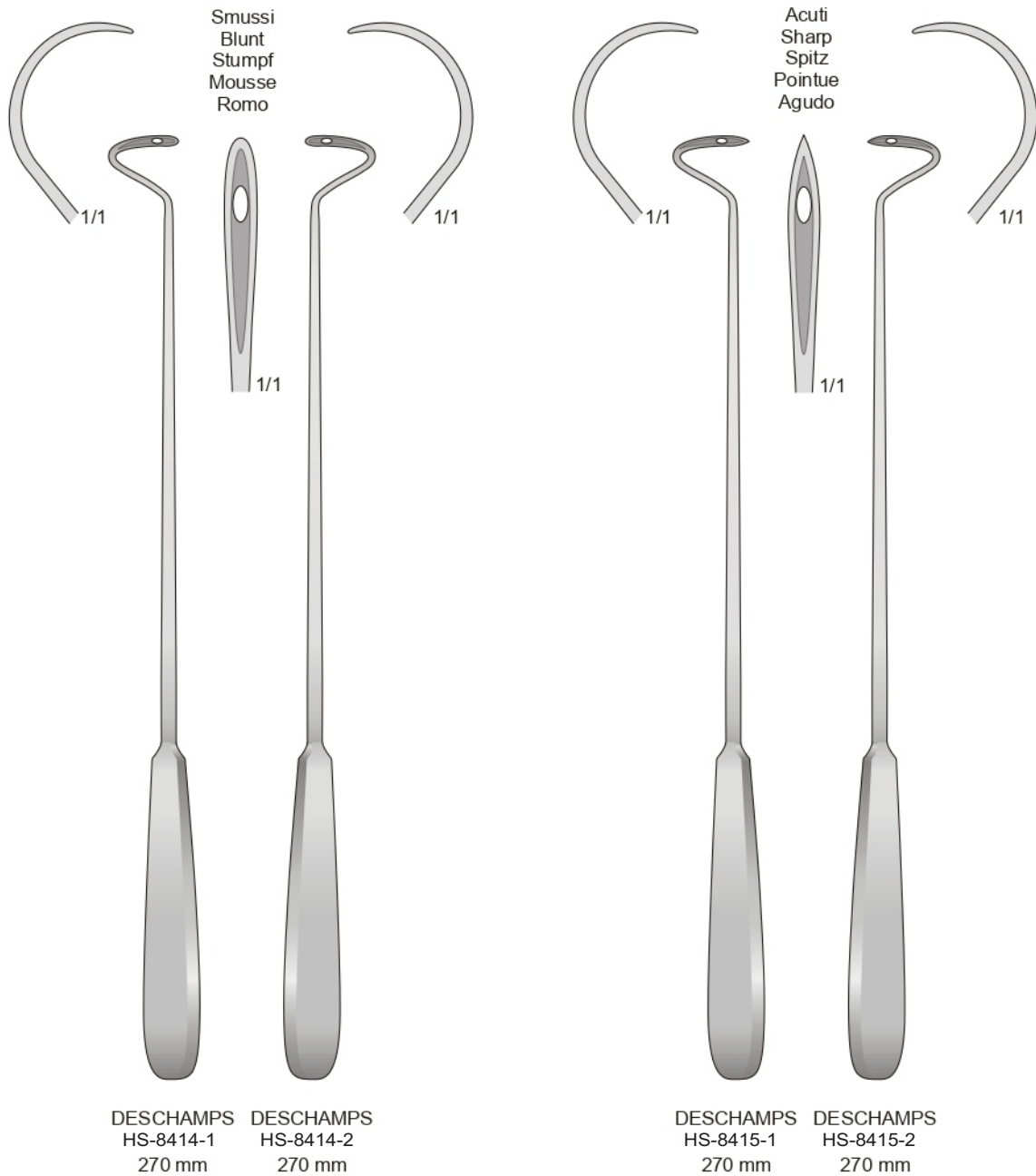



DESCHAMPS HS-8416-1 240 mm
DESCHAMPS HS-8416-2 240 mm

DESCHAMPS HS-8417-1 280 mm
DESCHAMPS HS-8417-2 280 mm

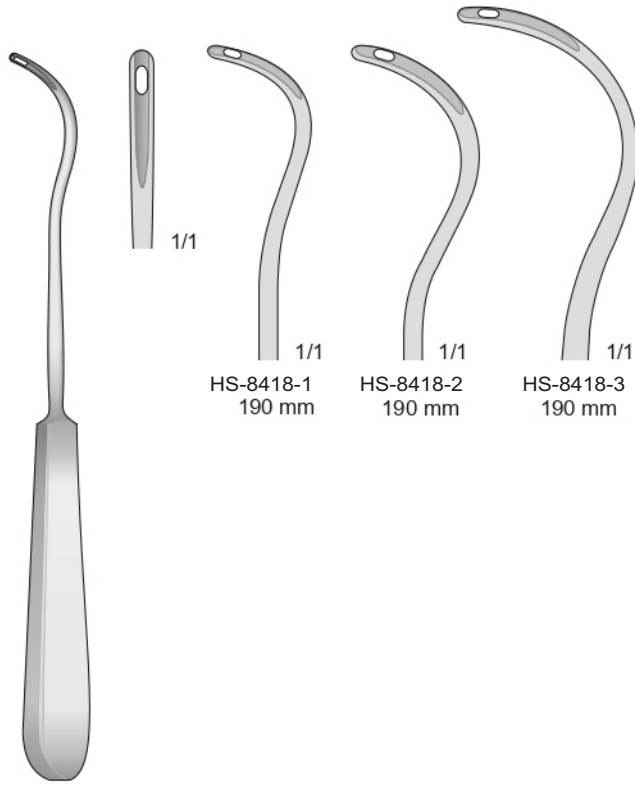

HS-8418-1
190 mm

HS-8418-2
190 mm

HS-8418-3
190 mm

Malleabile
Flexible
Biegsam
Souple
Maleable

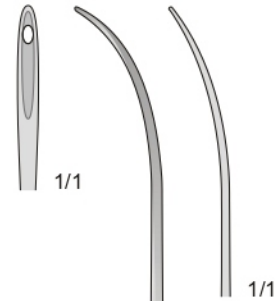

KOCHER
HS-8418
190 mm

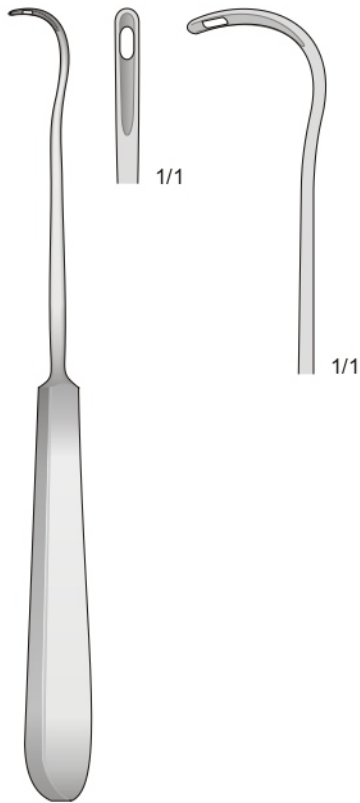

COOPER
HS-8419
200 mm

COOPER
HS-8420
190 mm

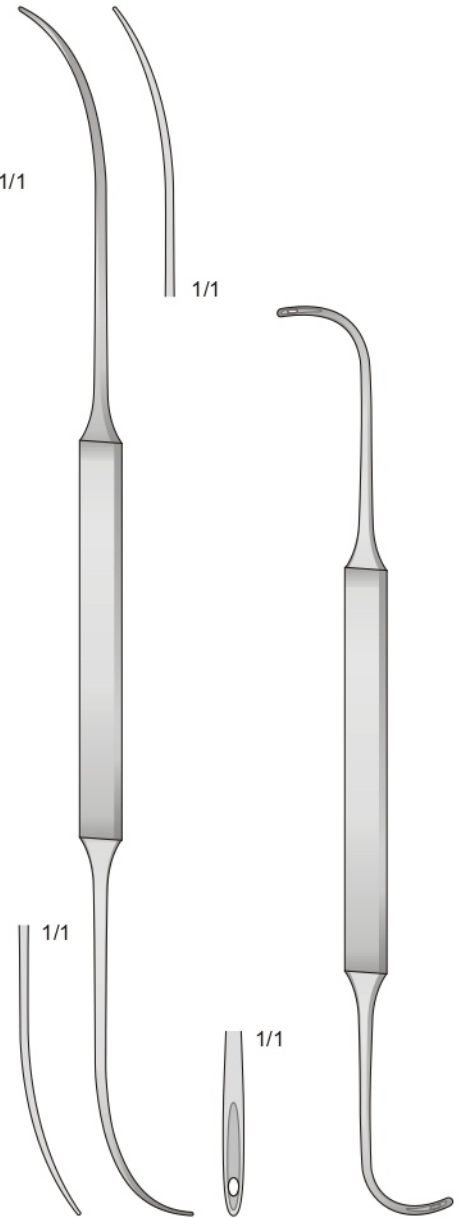

SCHMIEDEN-DICK
HS-8421
320 mm

SCHMIEDEN
HS-8422
210 mm

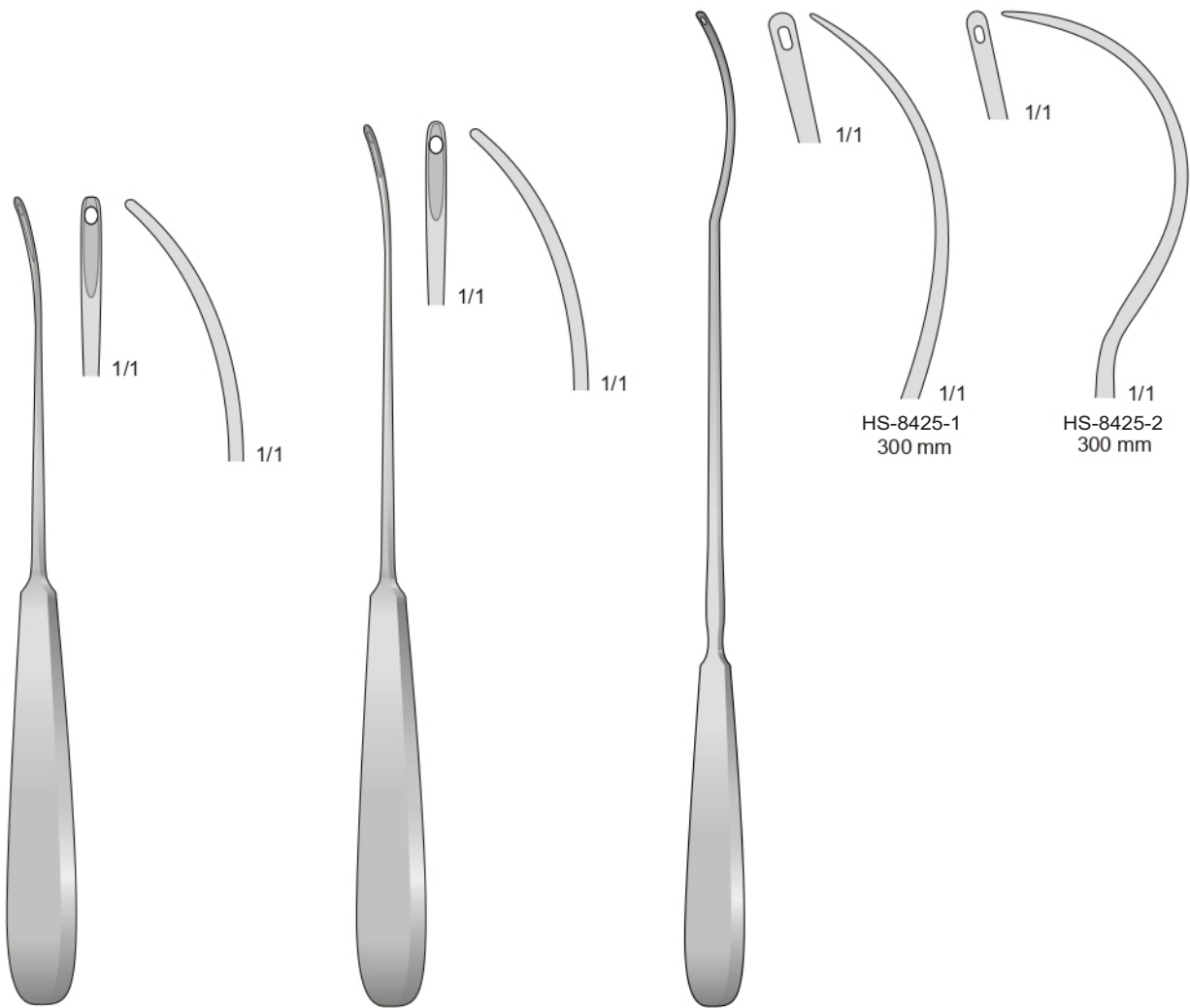

HS-8423
200 mm

HS-8424
230 mm

BRUNNER
HS-8425
300 mm

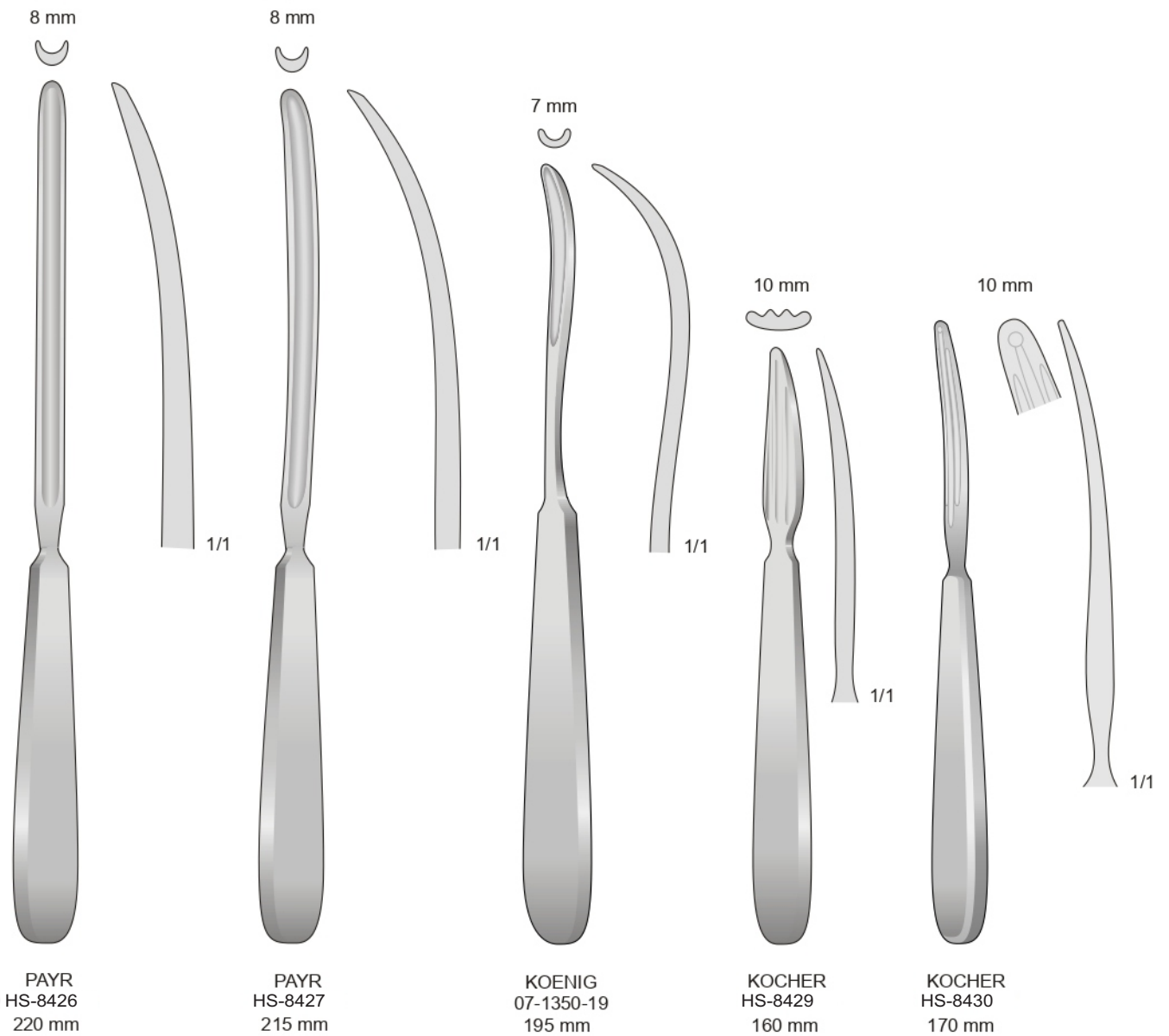

Char. 8	= 2,75 mm
Char 10	= 3,3 mm
Char 12	= 4 mm
Char 14	= 4,6 mm
Char 16	= 5,3 mm
Char 18	= 6 mm



Punta a coltello
Messerspitze gebogen
Knife tip curved



Punta a coltello
Messerspitze gebogen
Knife tip curved



Punta a lancetta
Lanzettenspitze gebogen
Lancet tip curved



Punta Trocar
Dreikantspitze gebogen
Trocar tip curved

Charr.

8	HS-8431-1
10	HS-8431-2
12	HS-8431-3
14	HS-8431-4
16	HS-8431-5
18	HS-8431-6

HS-8432-1
HS-8432-2
HS-8432-3
HS-8432-4
HS-8432-5
HS-8432-6

HS-8433-1
HS-8433-2
HS-8433-3
HS-8433-4
HS-8433-5
HS-8433-6

HS-8434-1
HS-8434-2
HS-8434-3
HS-8434-4
HS-8434-5
HS-8434-6



1/1

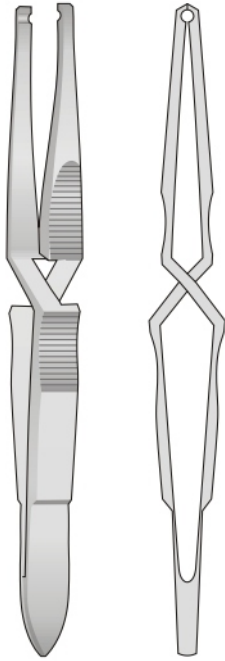

HEGENBARTH
HS-8435
125 mm

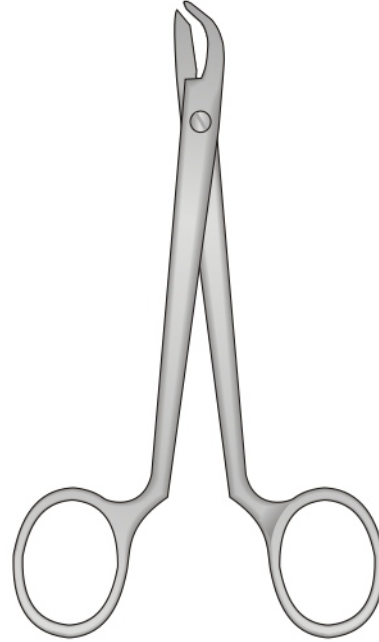

COLLIN
HS-8436
135 mm

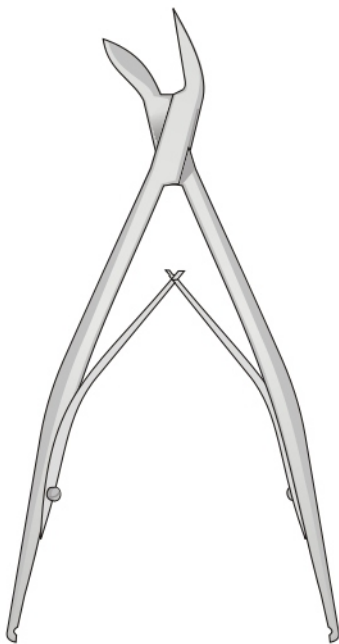

MICHEL
HS-8437
130 mm

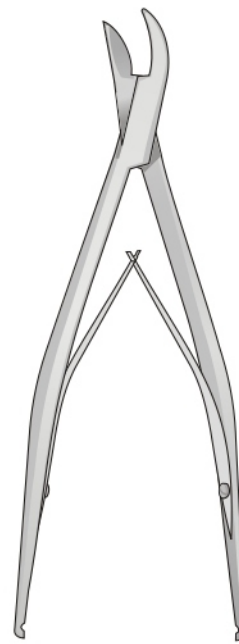

MICHEL
HS-8438
120 mm



Health Fast Surgical

Surgical Manufacturer Company



+92 (342) 880 9017



+92 (342) 880 9017



info@healthfastsurgical.com



www.healthfastsurgical.com



Dogra Khurd, P.O Harrar Sialkot-51310 Pakistan.



ISO
9001:2008

