

Surgical

INSTRUMENTS CATALOGUE



***Mallet
Osteotome
Bone Chisel***



Health Fast Surgical
Surgical Manufacturer Company

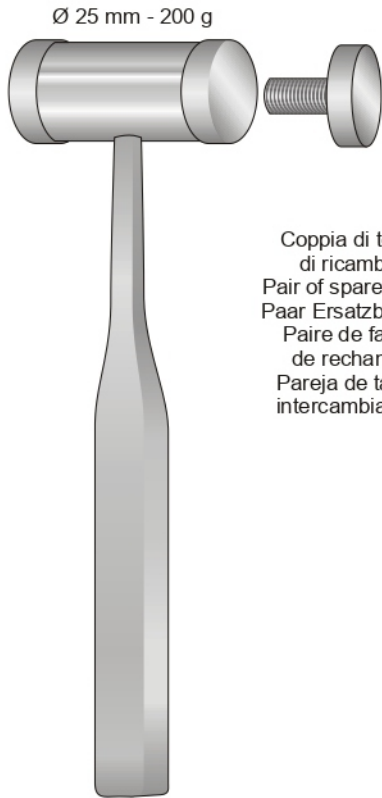

Coppia di teste di ricambio
Pair of spare faces
Paar Ersatzbacken
Paire de faces de rechange
Pareja de tapas intercambiables

MEAD
HS-8001
200 mm

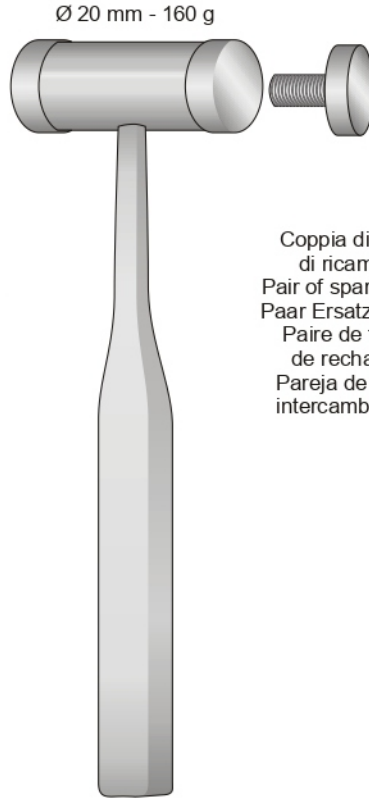

Coppia di teste di ricambio
Pair of spare faces
Paar Ersatzbacken
Paire de faces de rechange
Pareja de tapas intercambiables

MEAD
HS-8002
190 mm

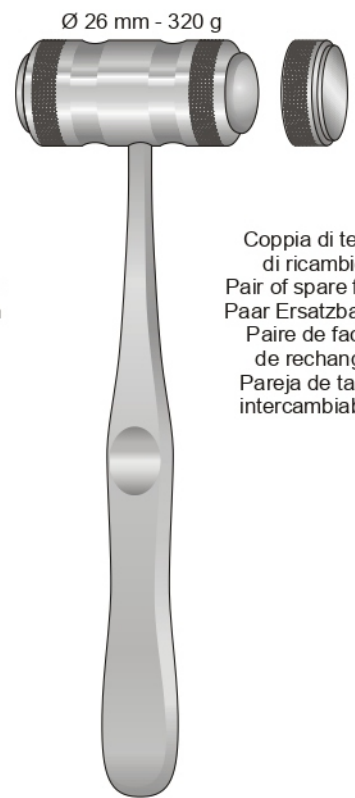

Coppia di teste di ricambio
Pair of spare faces
Paar Ersatzbacken
Paire de faces de rechange
Pareja de tapas intercambiables

MEAD
HS-8003
190 mm

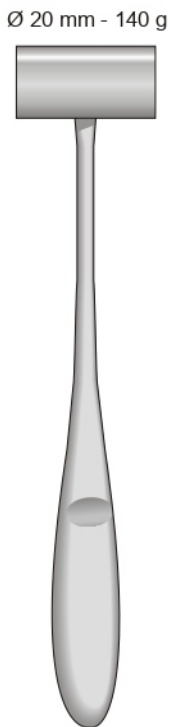

HS-8004
165 mm

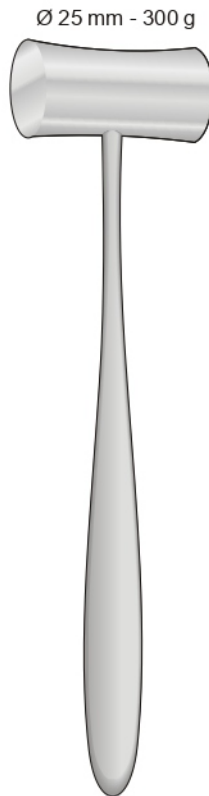

LUCAE
HS-8005
190 mm

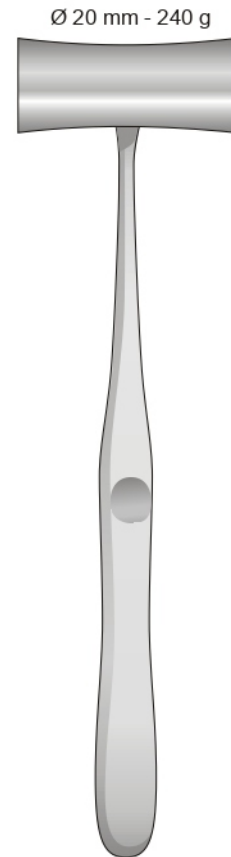

WILLIGER
HS-8006
240 mm



1 Lato piatto - 1 Lato convesso
1 Side flat - 1 Side convex
1 Seite flach - 1 Seite convex
1 Face plate - 1 Face convexe
1 Parte plana - 1 Parte convexa

Ø 30 mm - 240 g



COTTLE
HS-8007
185 mm

Ø 30 mm - 300 g



BERGMANN
HS-8008
235 mm

Ø 45 mm - 300 g



BERGMANN
HS-8009
245 mm



HS-8010
240 mm

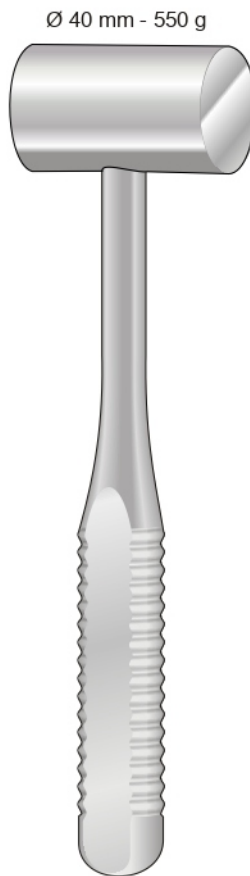

OMBREDANNE
HS-8011
240 mm



HEAT
HS-8012
185 mm

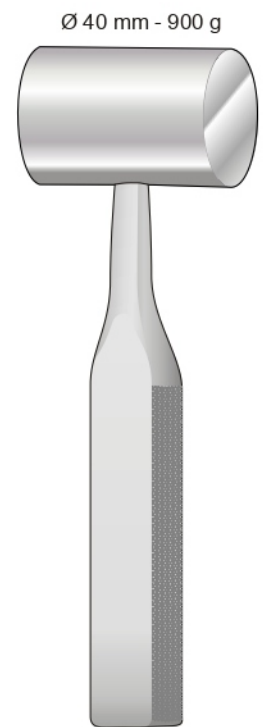

HS-8013
190 mm

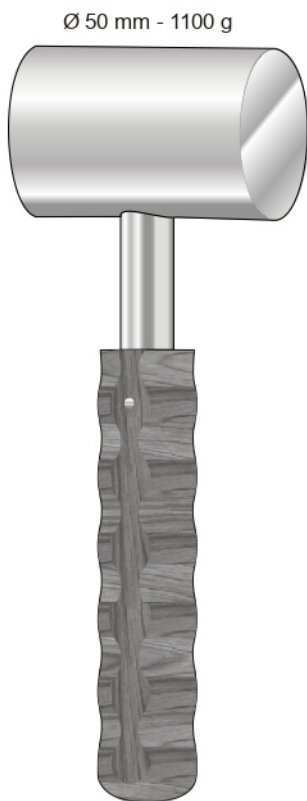

HS-8014
200 mm



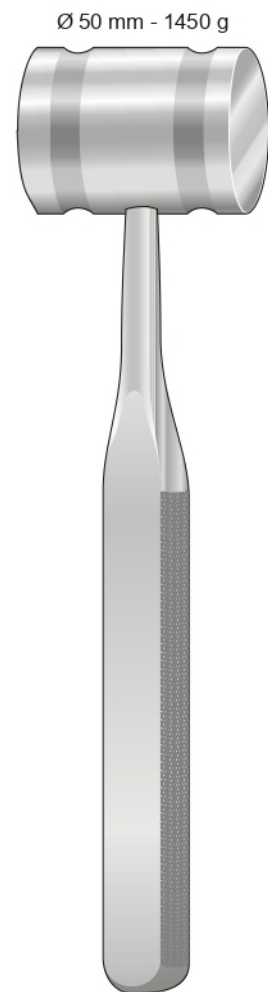

HS-8015
260 mm



HS-8016
270 mm



-  HS-8017-1
Ø3 mm
-  HS-8017-2
Ø5 mm
-  HS-8017-3
Ø8 mm

CASPAR
HS-8017
200 mm

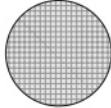
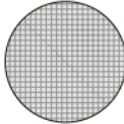

-  HS-8018-1
Ø12 mm
-  HS-8018-2
Ø14 mm
-  HS-8018-3
Ø16 mm

HS-8018
200 mm



-  HS-8019-1
3x8 mm
-  HS-8019-2
4x10 mm
-  HS-8019-3
5x15 mm
-  HS-8019-4
6x20 mm

SYPERT
HS-8019
290 mm

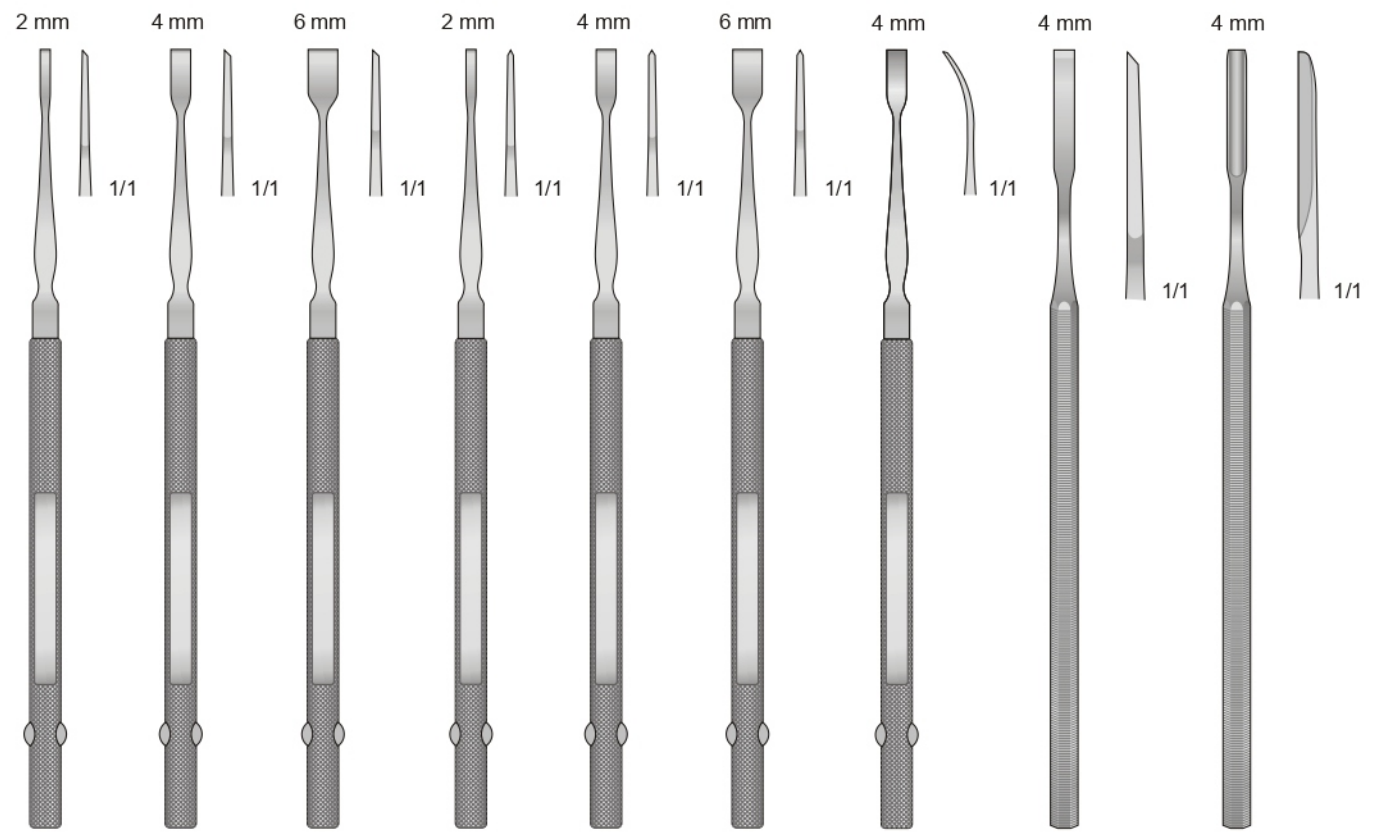
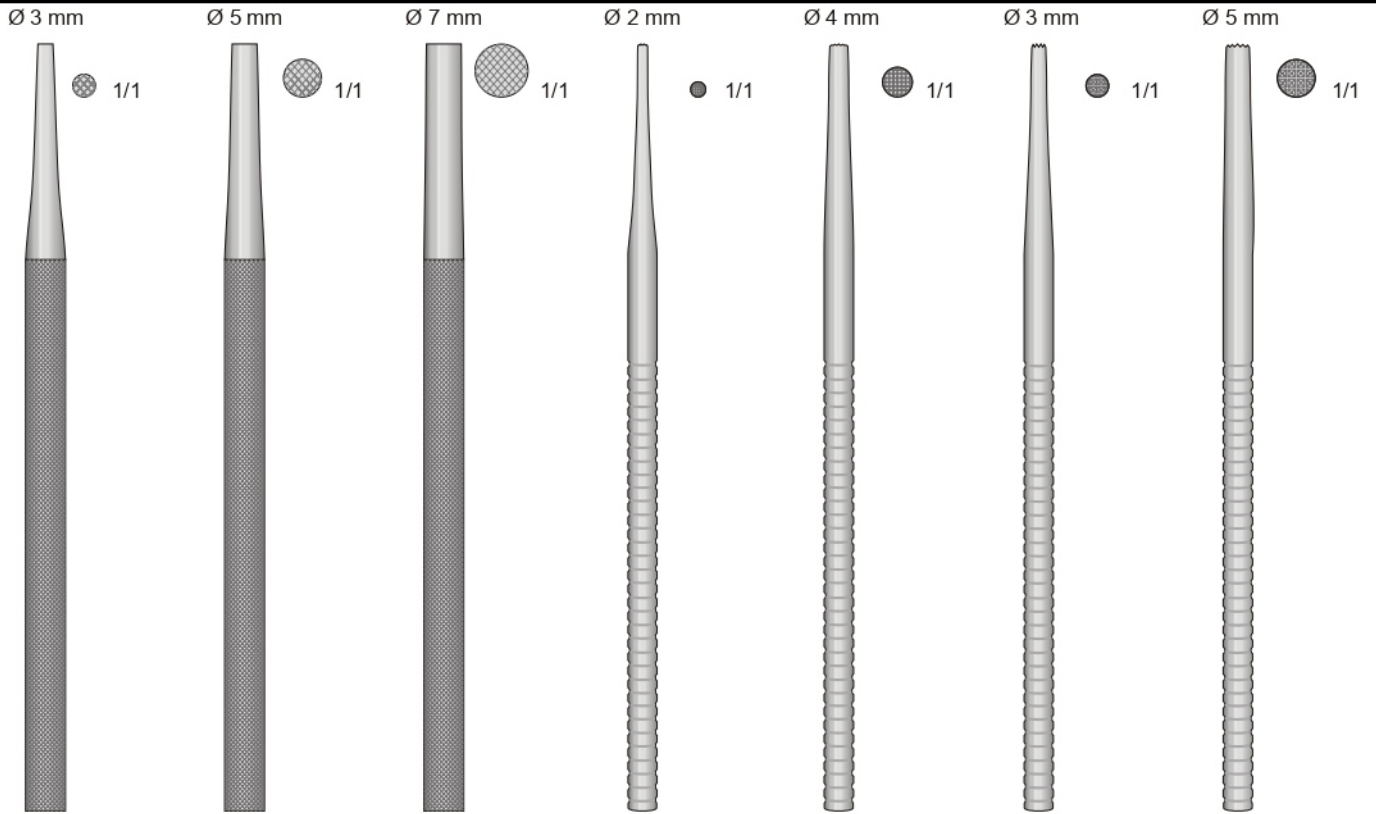



Osteotomes - Gouges

Osteotomi - Osteotomes
Osteotome - Ostéotomes - Osteótomos

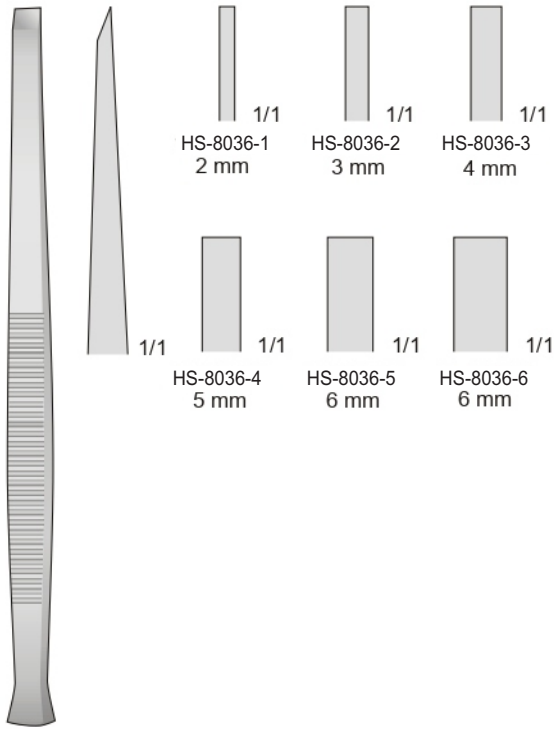

PARTSCH
HS-8036
140 mm

Sgorbie - Gouges
Hohlmeissel - Gouges - Gubias

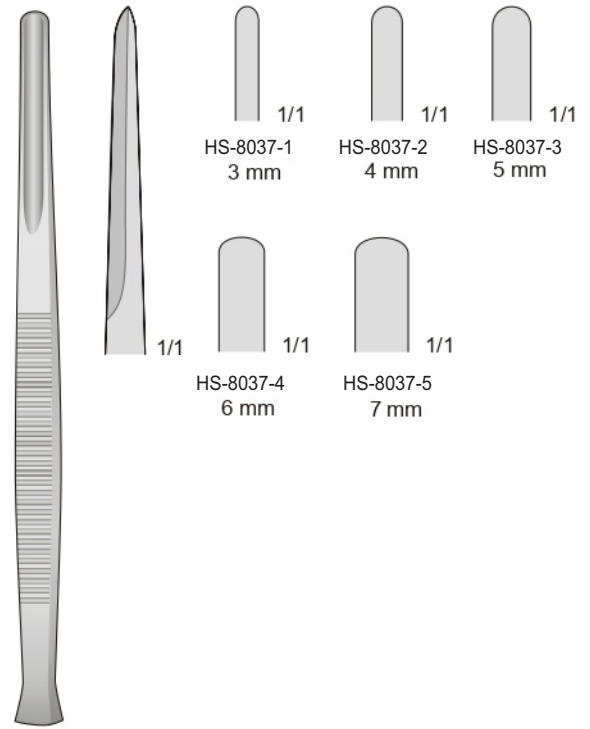

PARTSCH
HS-8037
140 mm

Osteotomi - Osteotomes
Osteotome - Ostéotomes - Osteótomos

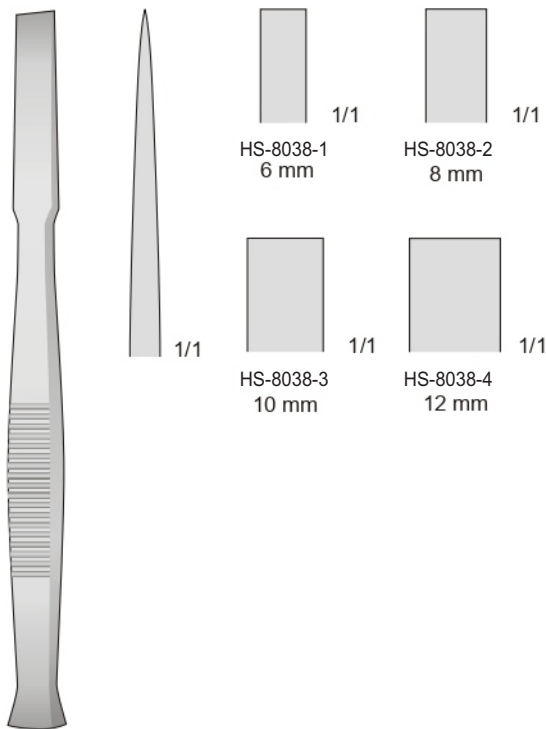

HS-8038
140 mm

Sgorbie - Gouges
Hohlmeissel - Gouges - Gubias

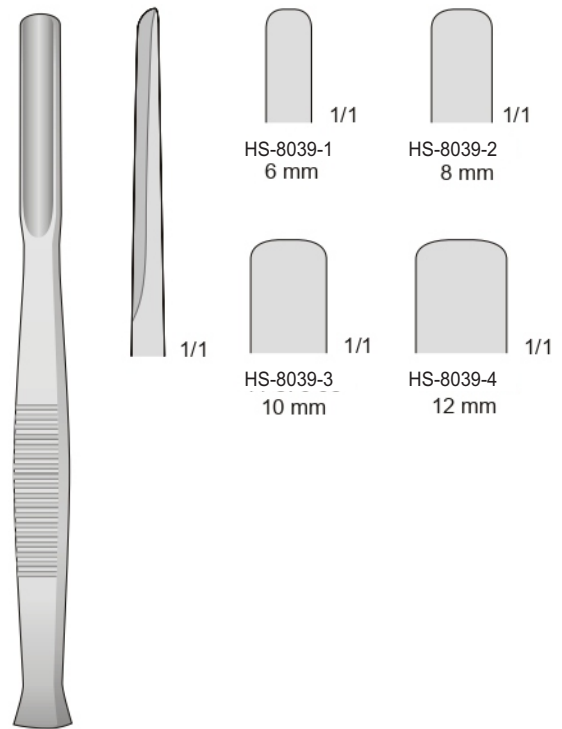

HS-8039
140 mm

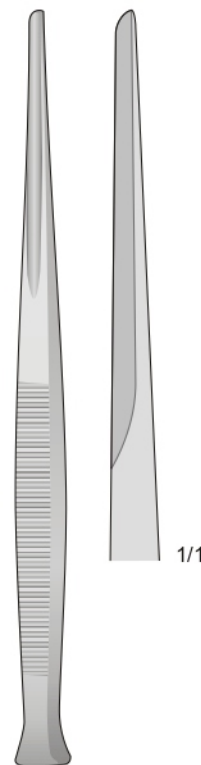
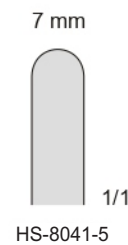
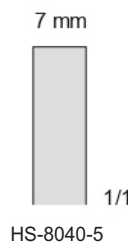
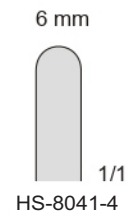
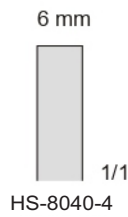
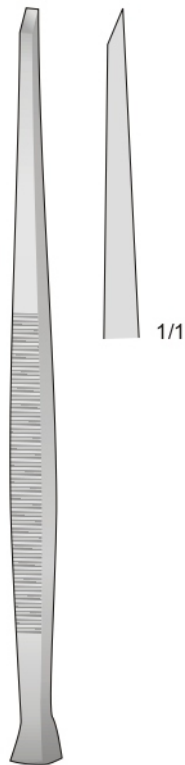
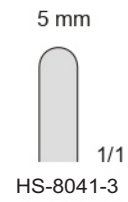
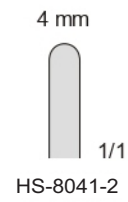
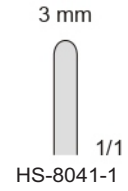
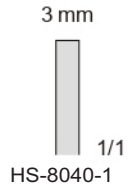

PARTSCH
 HS-8040
 170 mm

PARTSCH
 HS-8041
 170 mm

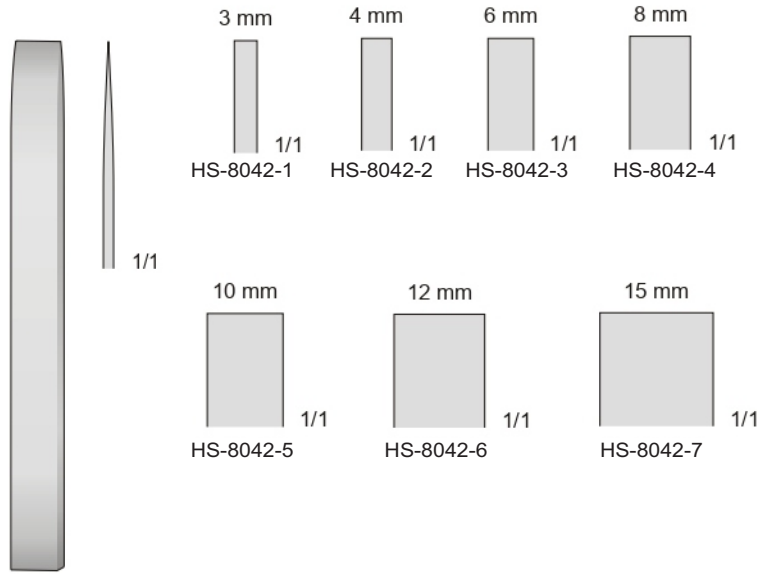

MINI-LAMBOTTE
HS-8042
125 mm

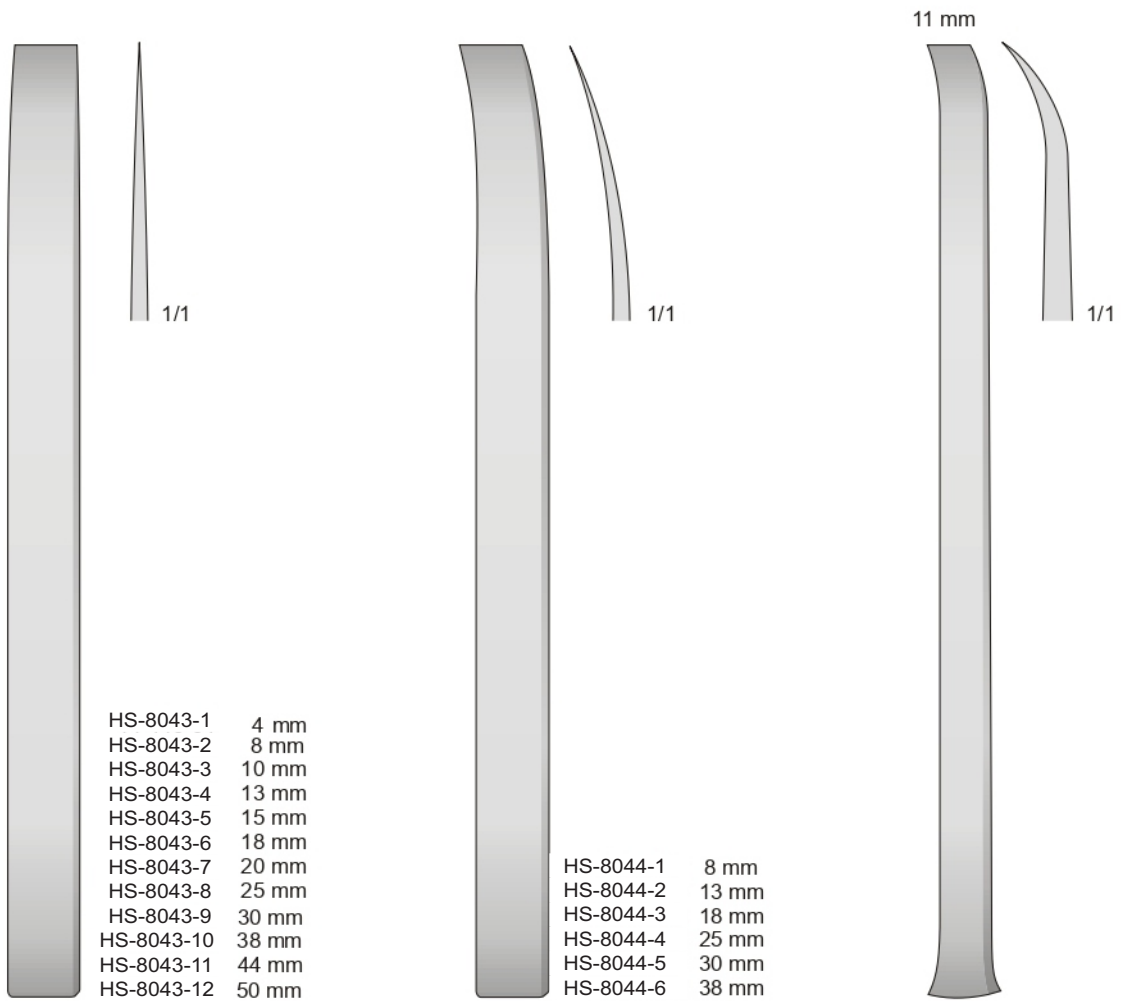

LAMBOTTE
HS-8043
250 mm

LAMBOTTE
HS-8044
250 mm

OBWEGESER
HS-8045
235 mm

Osteotomes

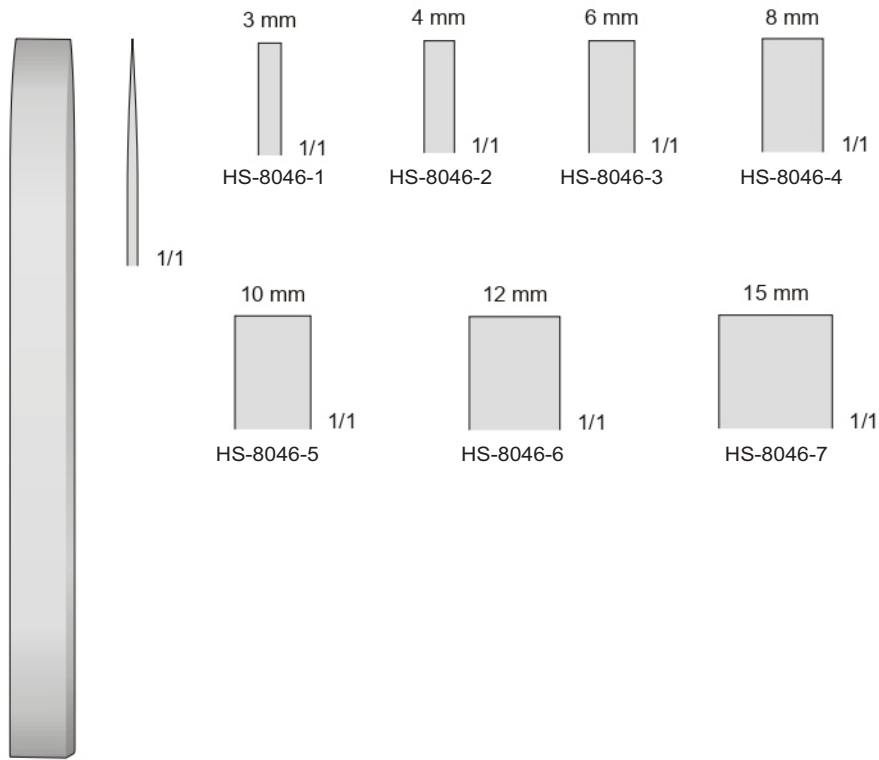

MINI-LAMBOTTE
HS-8046
170 mm

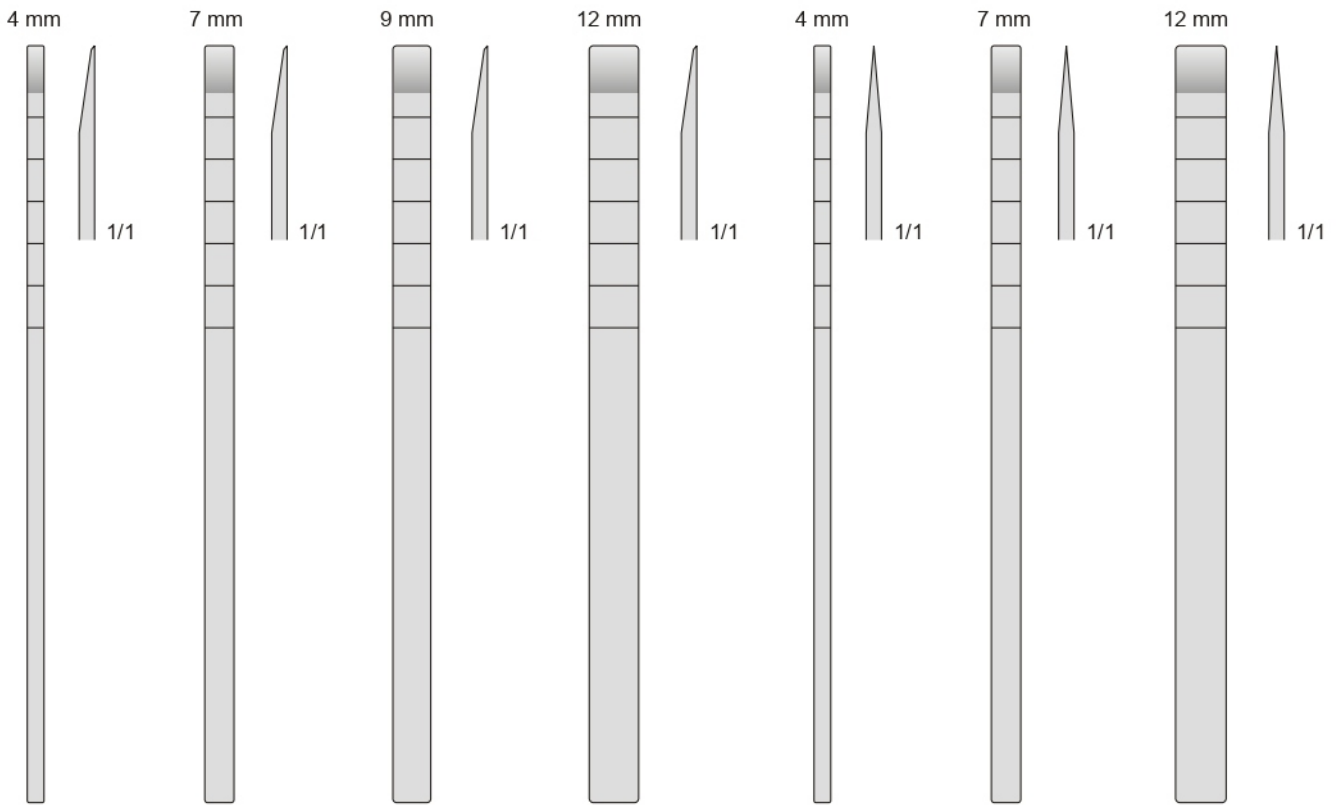

COTTLE
HS-8047-1
180 mm

COTTLE
HS-8047-2
180 mm

COTTLE
HS-8047-3
180 mm

COTTLE
HS-8047-4
180 mm

COTTLE
HS-8047-5
180 mm

COTTLE
HS-8047-6
180 mm

COTTLE
HS-8047-7
180 mm

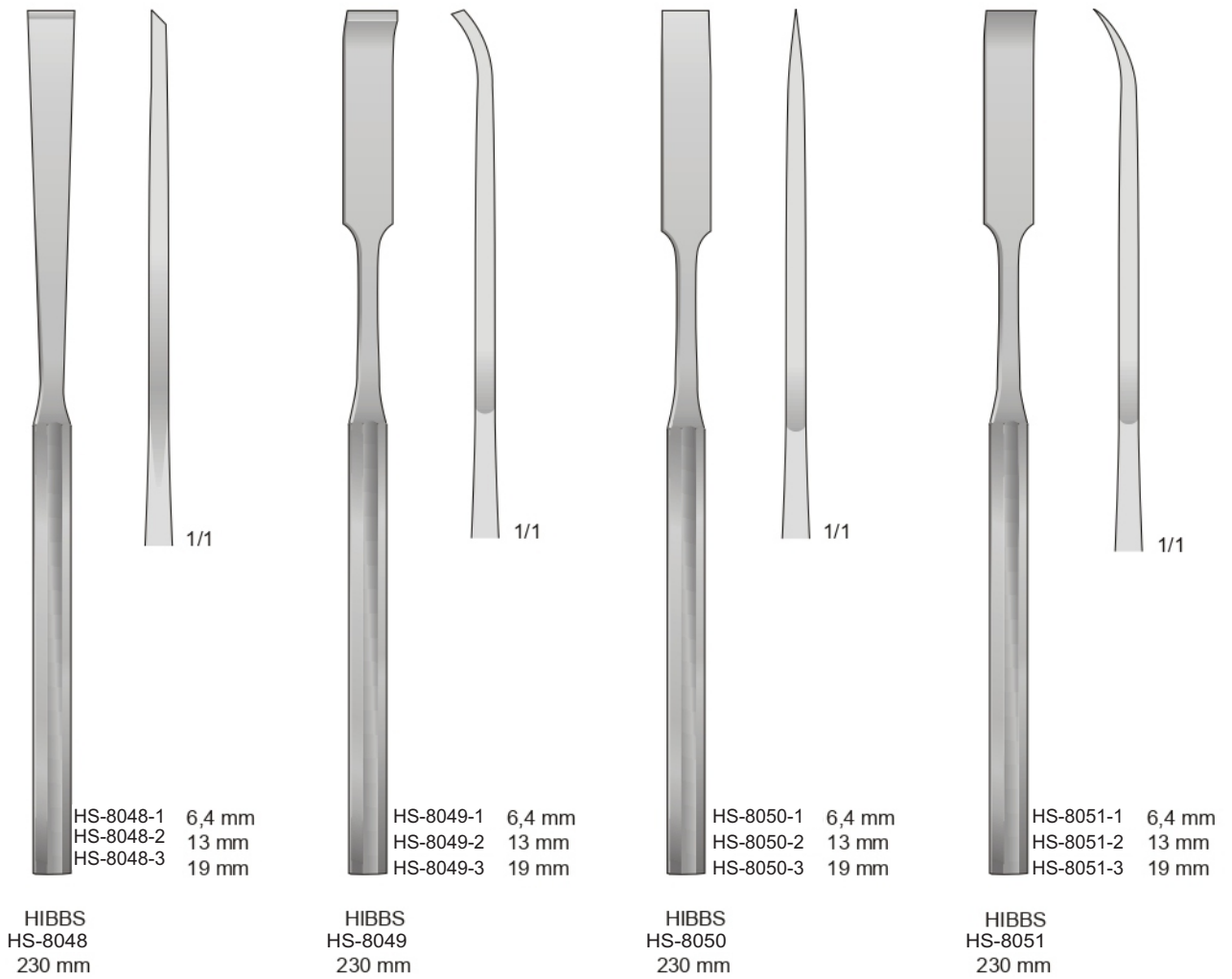



HS-8052
180 mm

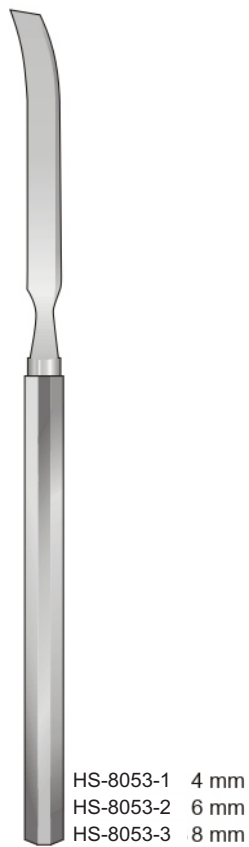

HS-8053
180 mm

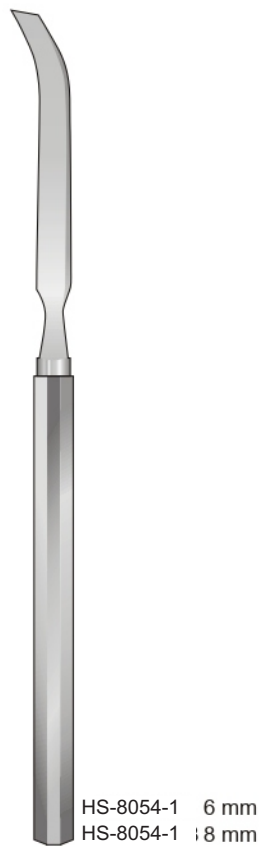

HS-8054
180 mm

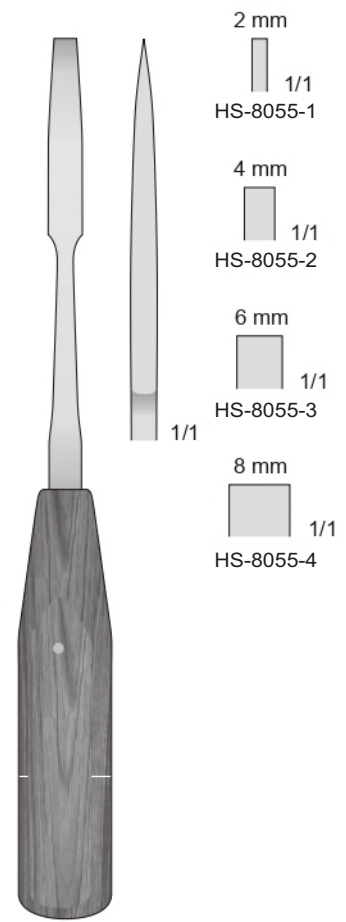

MINI-LEXER
HS-8055
200 mm

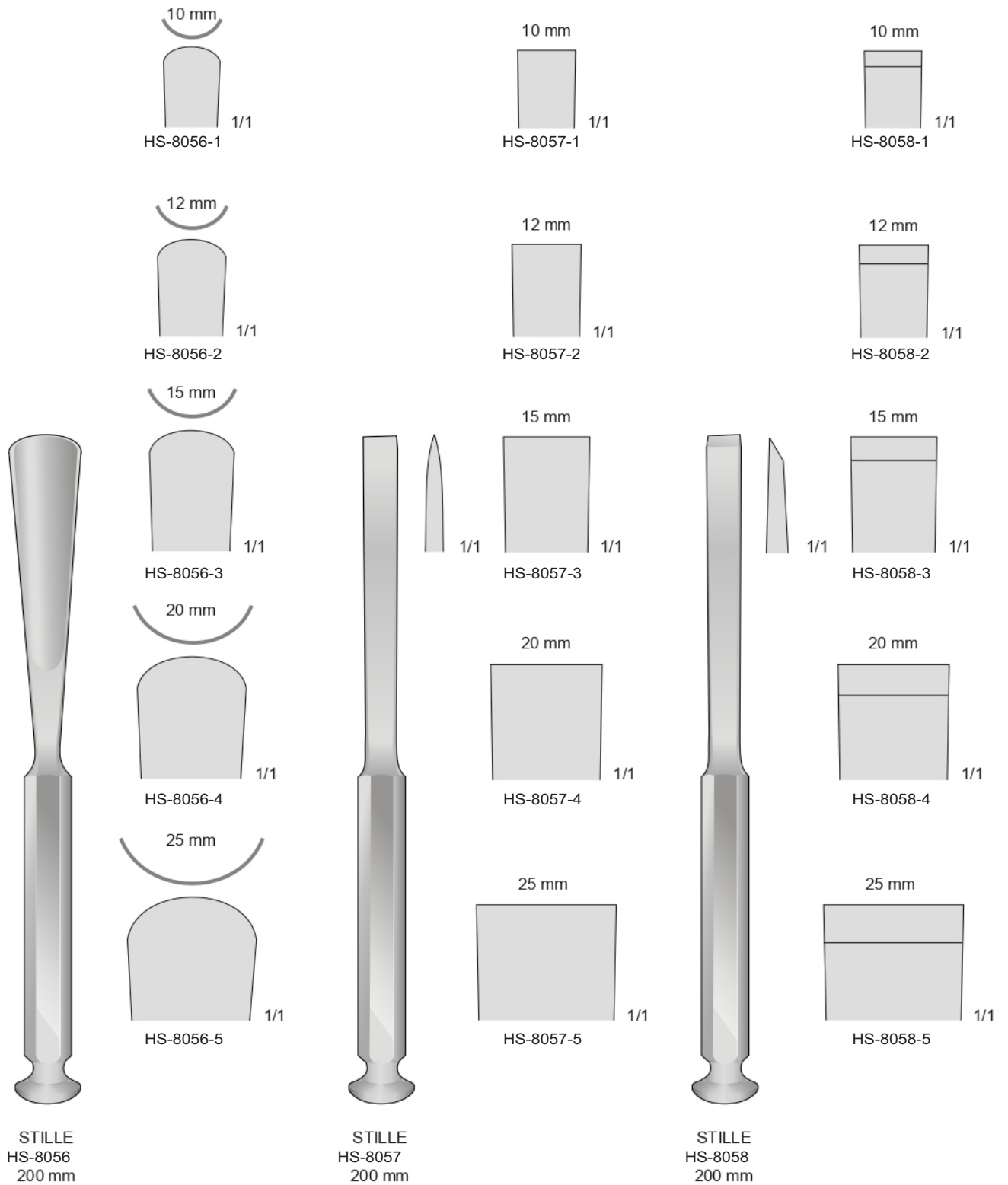

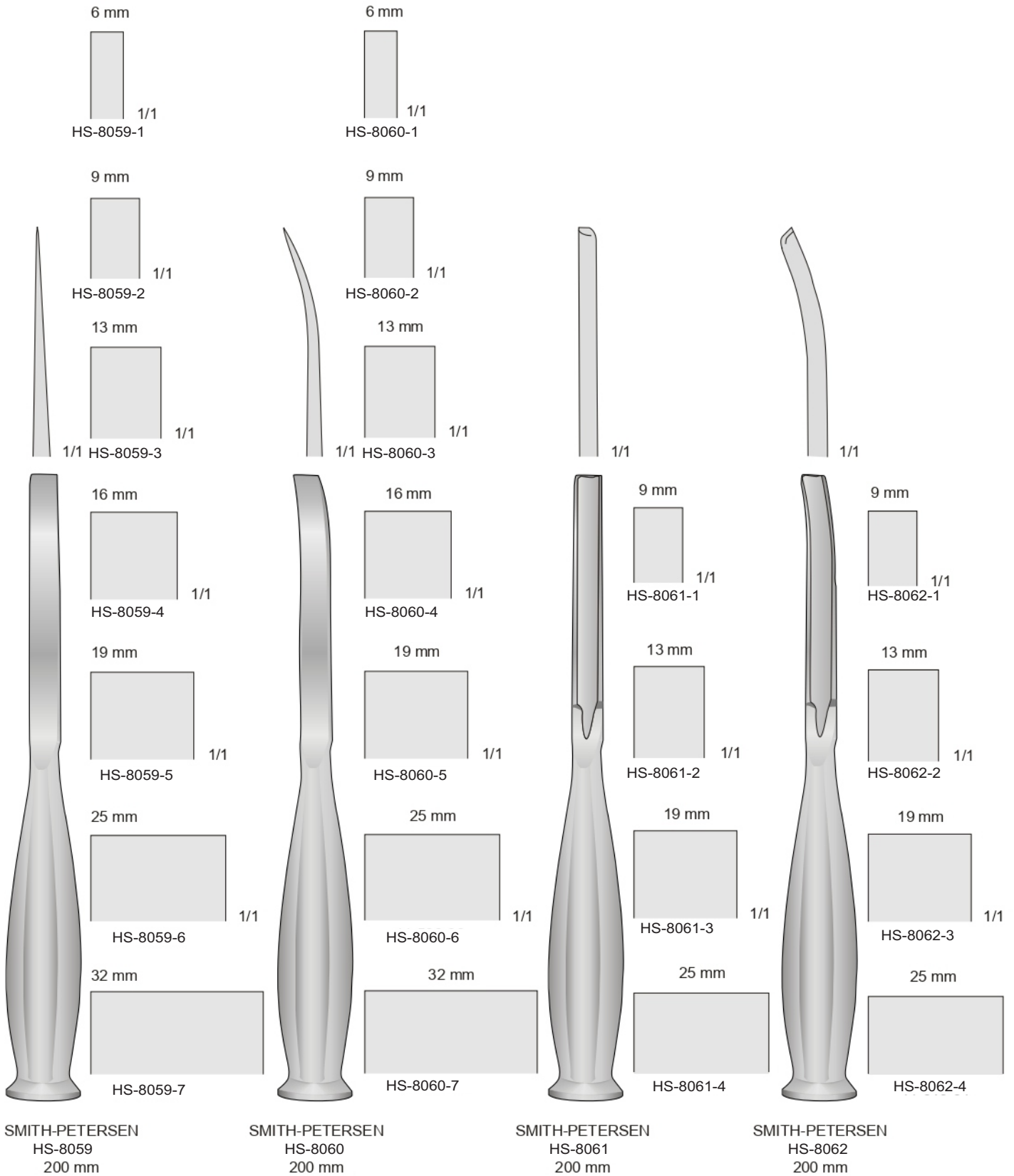

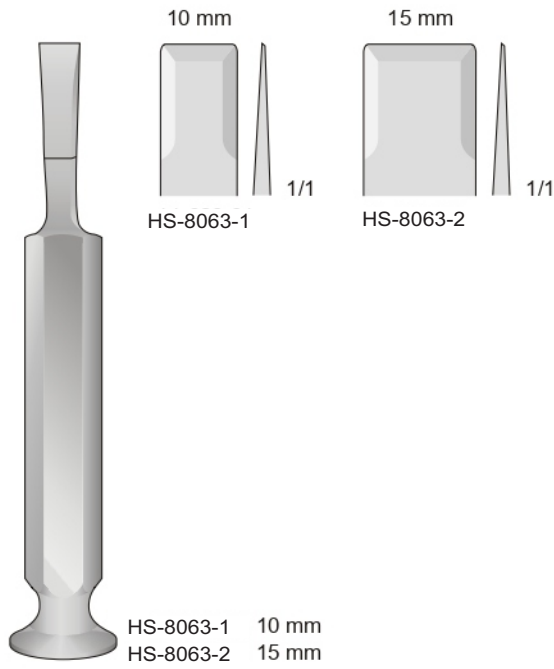

TESSIER
HS-8063
160 mm

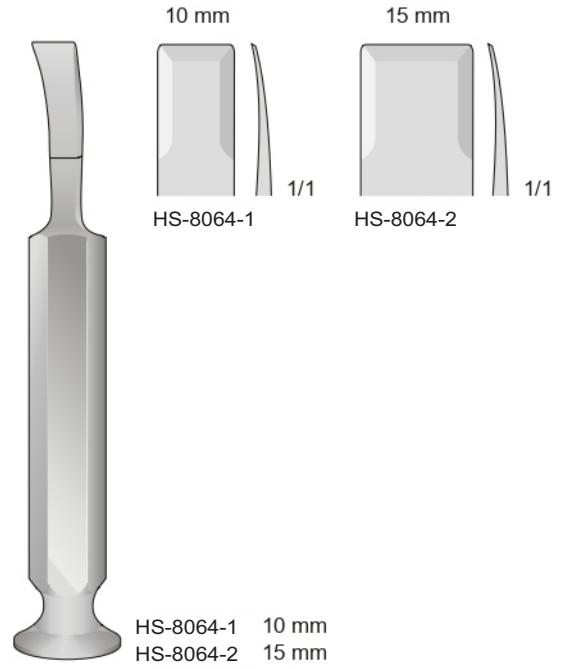

TESSIER
HS-8064
160 mm

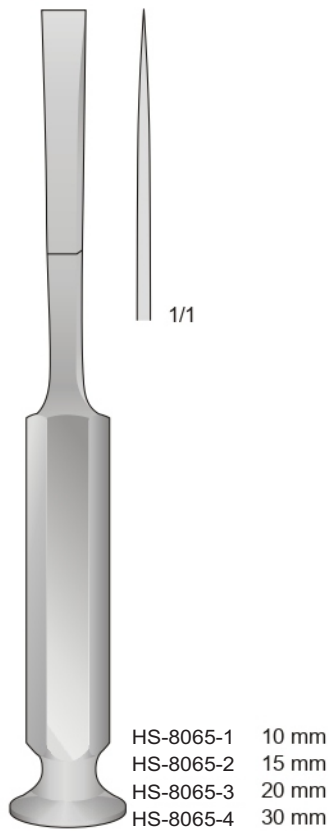

TESSIER
HS-8065
200 mm

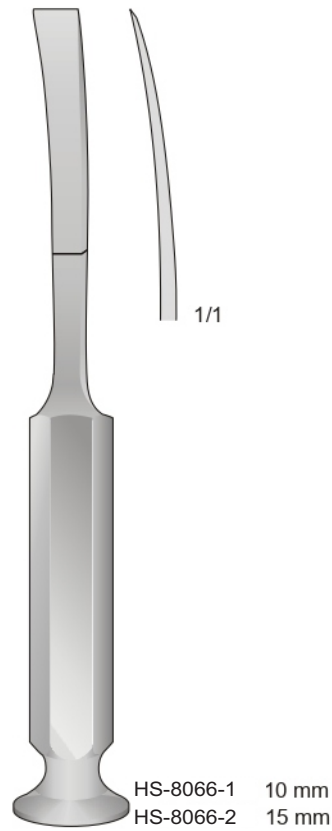

TESSIER
HS-8066
200 mm

Set completo di Set complete with Komplettsset mit Set complet avec Set completo con		
1 Manico portalamo in ferrozell	4 Lame Fig. 1-2-3-4	1 Chiave ferma lama
1 With Ferrozell handle	4 Blades Fig. 1-2-3-4	-
1 Mit Ferrozellgriff	4 Klingen Fig. 1-2-3-4	-
1 Avec poignée en Ferrozell	4 Lames Fig. 1-2-3-4	-
1 Con mango de Ferrozell	4 Hojas Fig. 1-2-3-4	-



HS-8067
190 mm

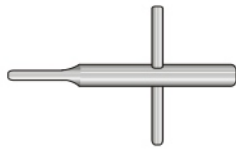

HS-8068
90 mm

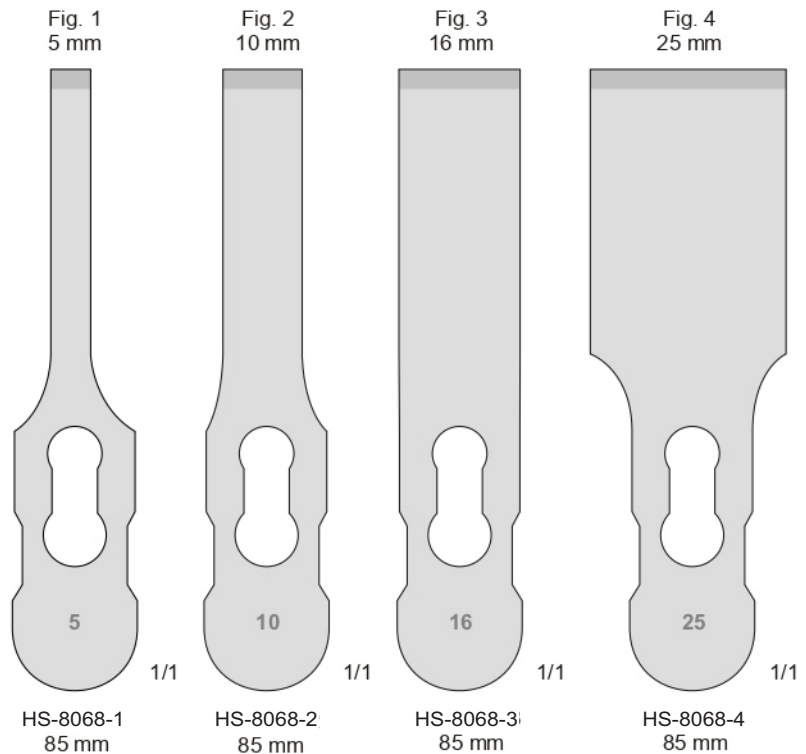

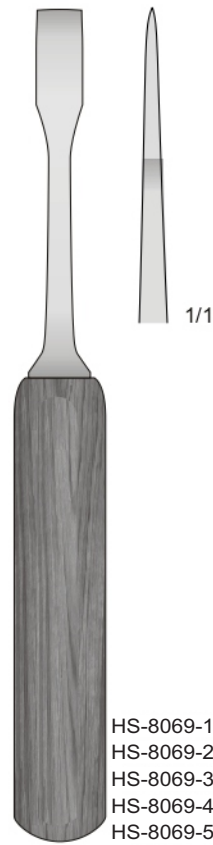

- HS-8069-1 4 mm
- HS-8069-2 6 mm
- HS-8069-3 8 mm
- HS-8069-4 10 mm
- HS-8069-5 12 mm

MINI-LEXER
HS-8069
180 mm



- HS-8070-1 4 mm
- HS-8070-2 6 mm
- HS-8070-3 8 mm
- HS-8070-4 10 mm
- HS-8070-5 12 mm

MINI-LEXER
HS-8070
180 mm

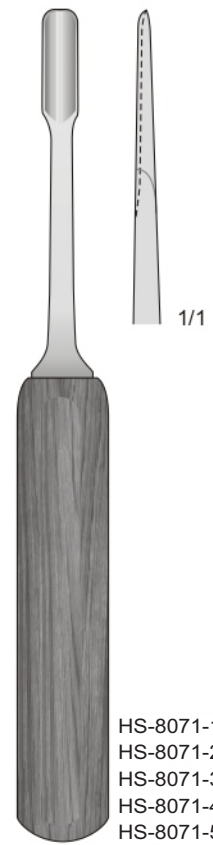

- HS-8071-1 4 mm
- HS-8071-2 6 mm
- HS-8071-3 8 mm
- HS-8071-4 10 mm
- HS-8071-5 12 mm

LEXER
HS-8071
180 mm

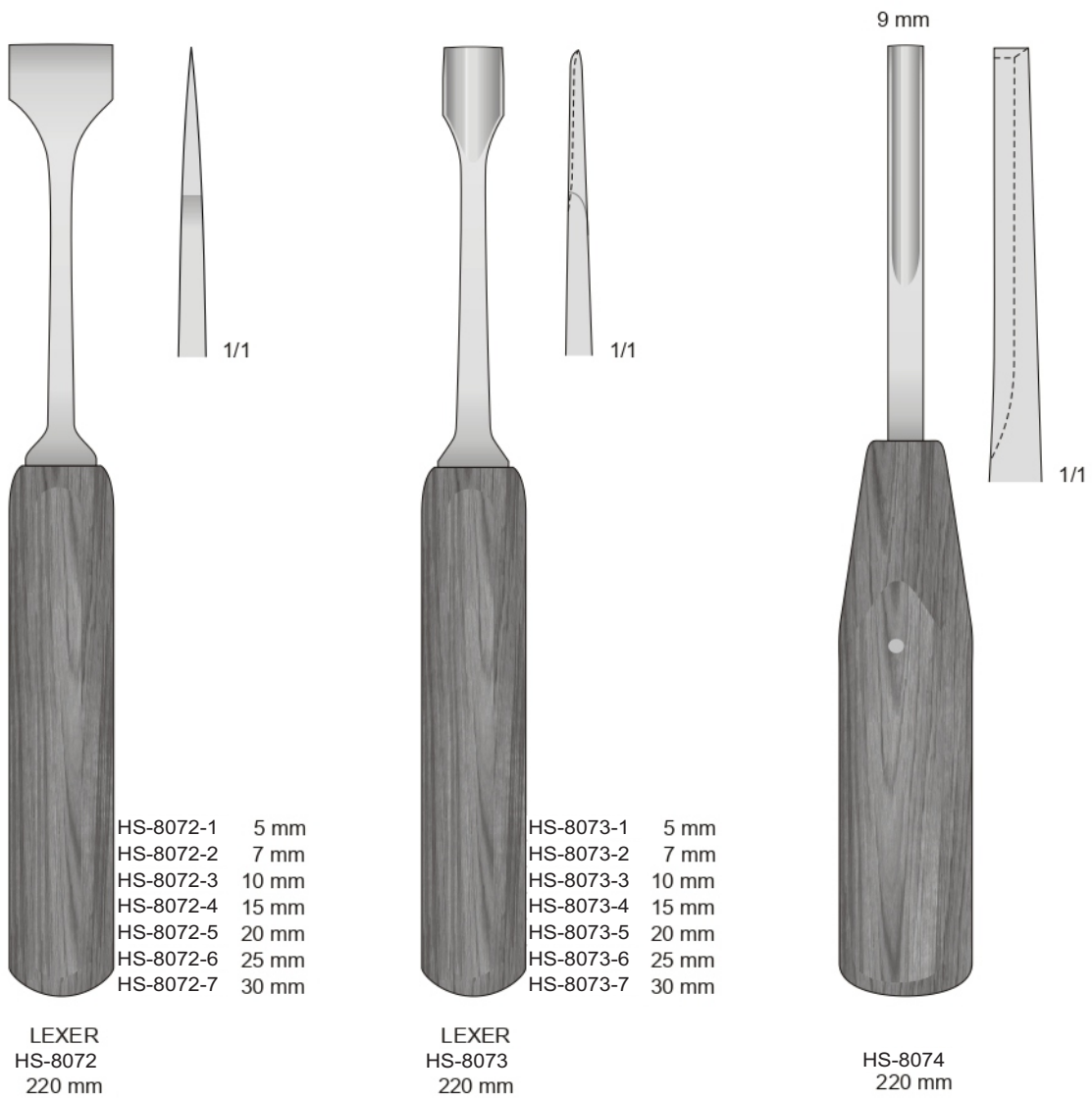

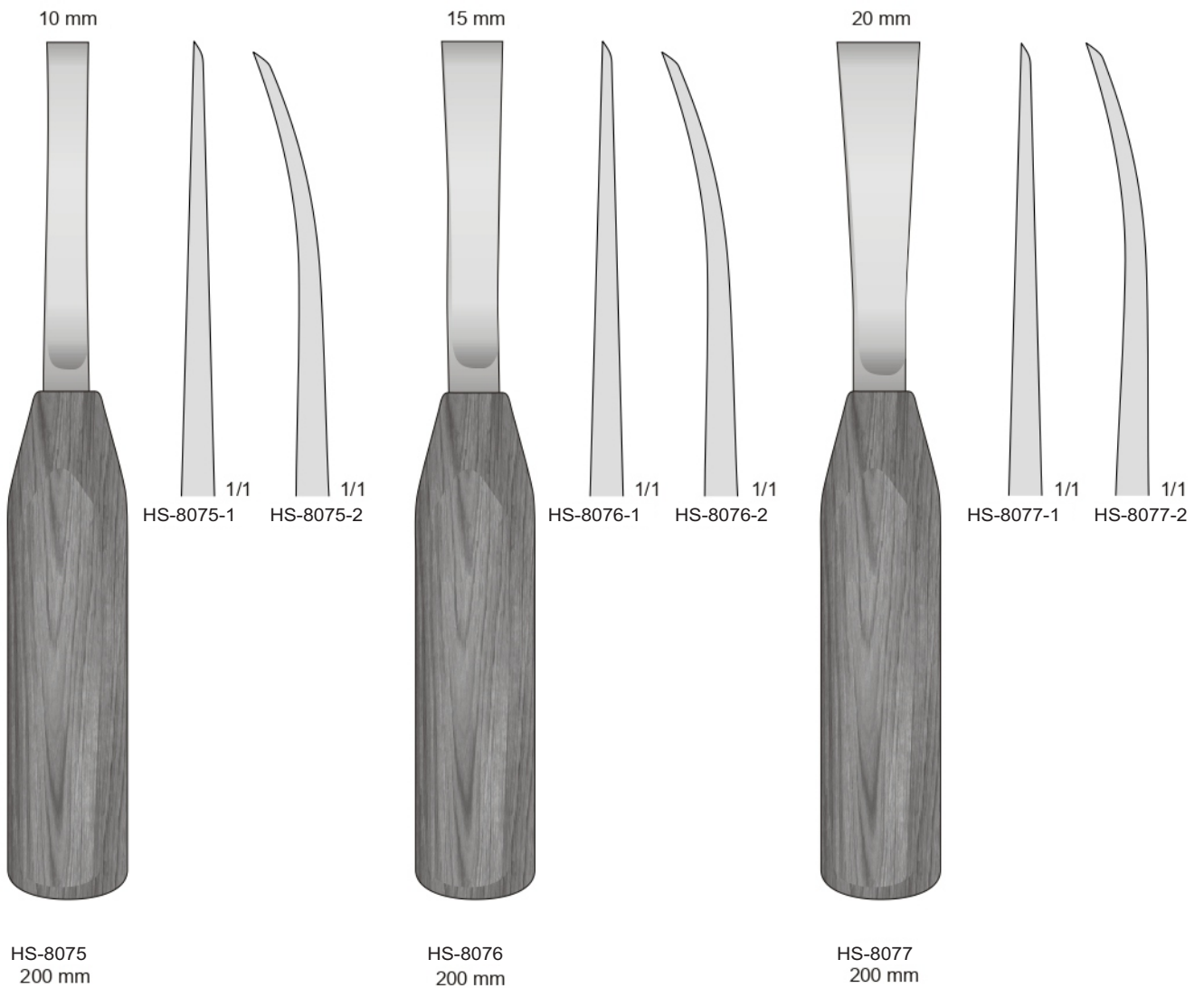



Sgorbie - Gouges
Hohlmeissel - Gouges - Gubias

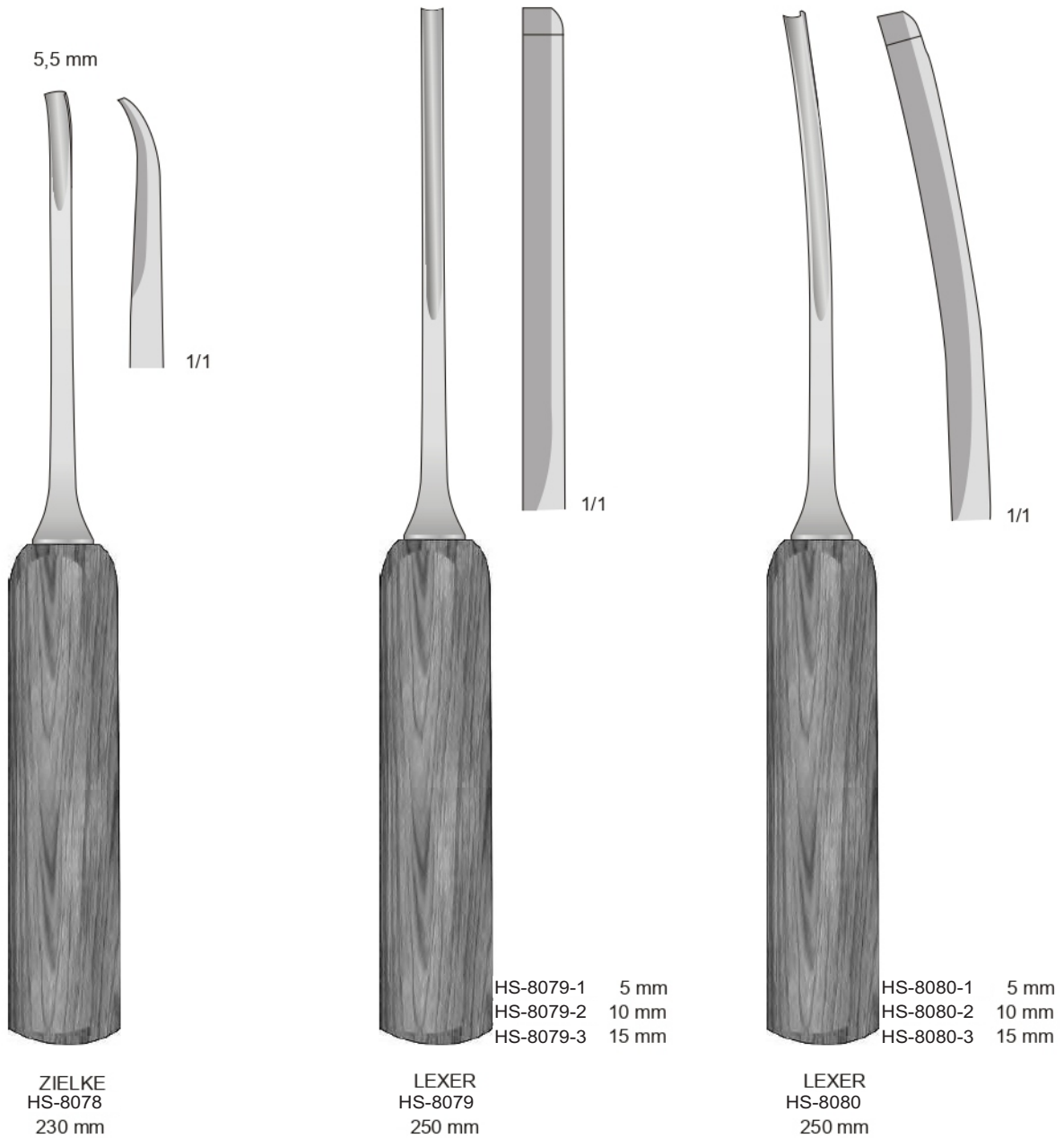

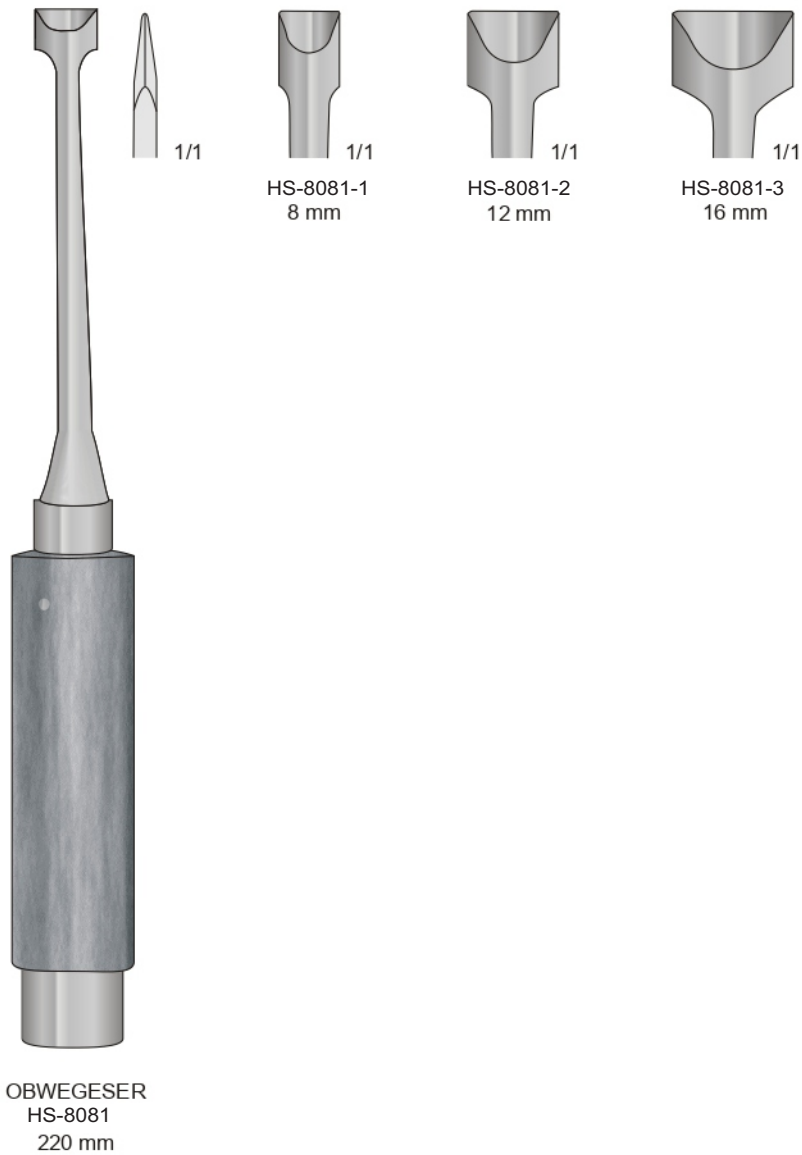

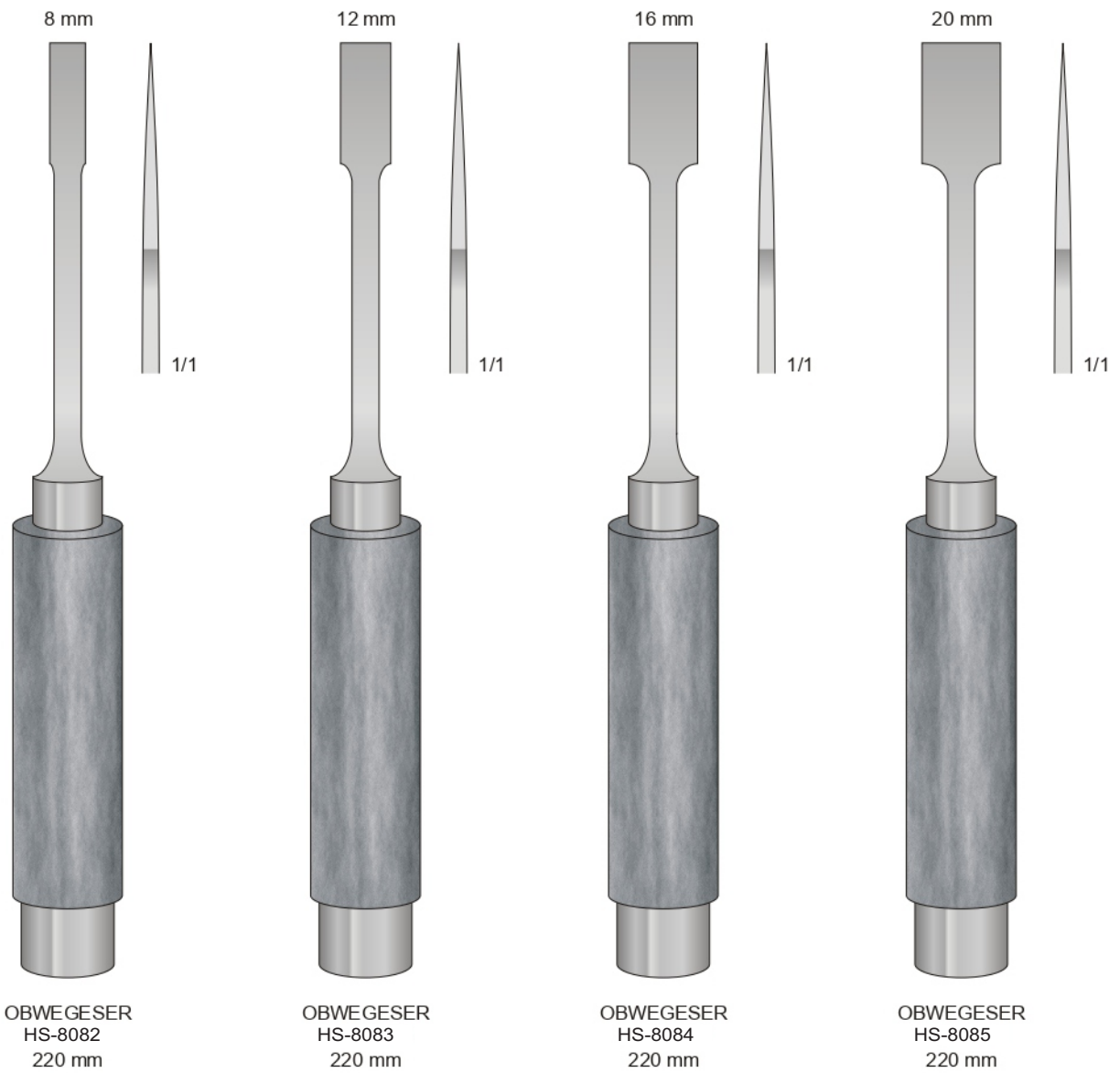



Health Fast Surgical

Surgical Manufacturer Company



+92 (342) 880 9017



+92 (342) 880 9017



info@healthfastsurgical.com



www.healthfastsurgical.com



Dogra Khurd, P.O Harrar Sialkot-51310 Pakistan.



ISO
9001:2008

