

# Surgical

INSTRUMENTS CATALOGUE



**Health Fast Surgical**  
Surgical Manufacturer Company

[www.healthfastsurgical.com](http://www.healthfastsurgical.com)

***Hemostatic Forceps***  
***Towel Clamps***

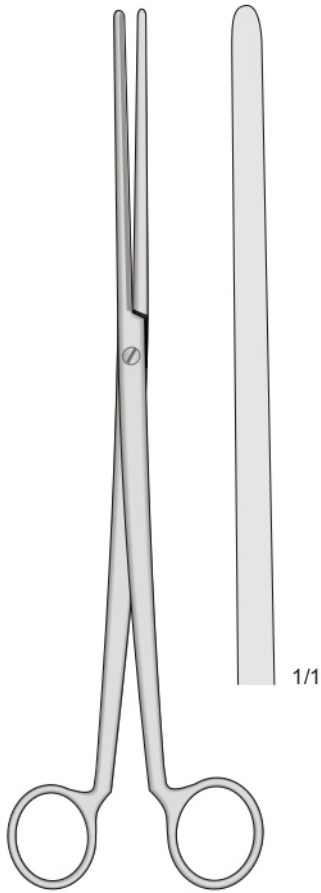

COLLIN  
HS-7601  
260 mm

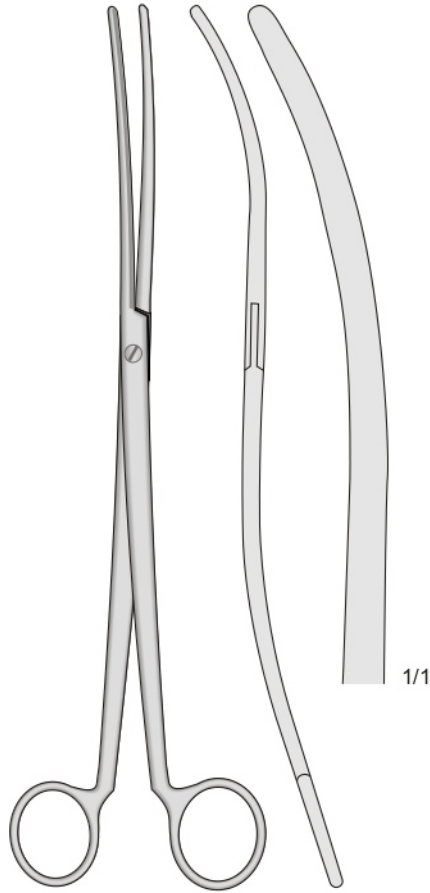

COLLIN  
HS-7602  
260 mm

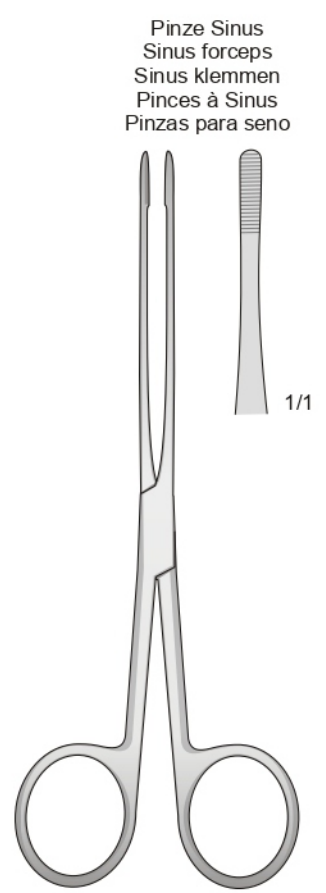

LISTER  
HS-7603  
150 mm

Pinze Sinus  
Sinus forceps  
Sinus klemmen  
Pincès à Sinus  
Pinzas para seno

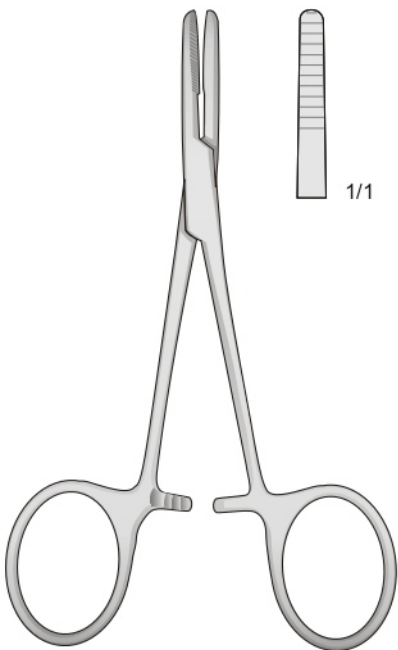

TERRIER  
HS-7604  
130 mm

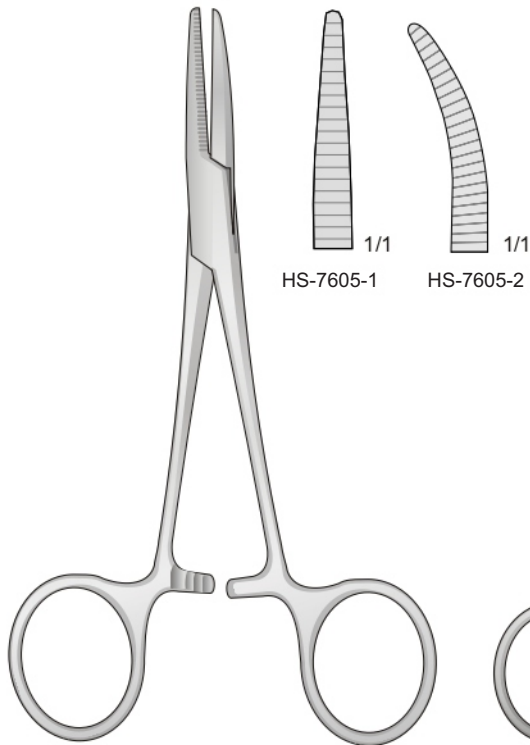

JONES  
HS-7605  
150 mm

HS-7605-1

HS-7605-2

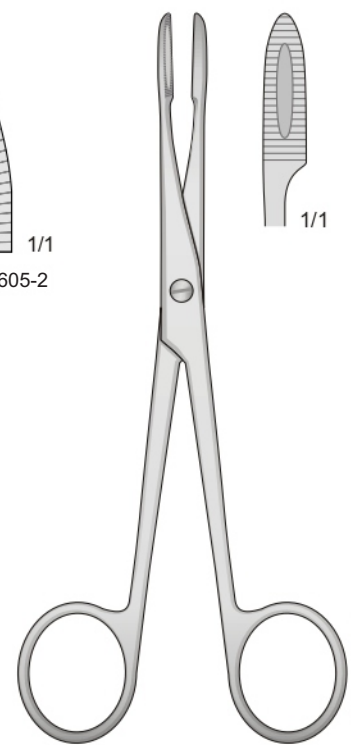

GROSS  
HS-7606-1 - 130 mm  
HS-7606-2 - 160 mm

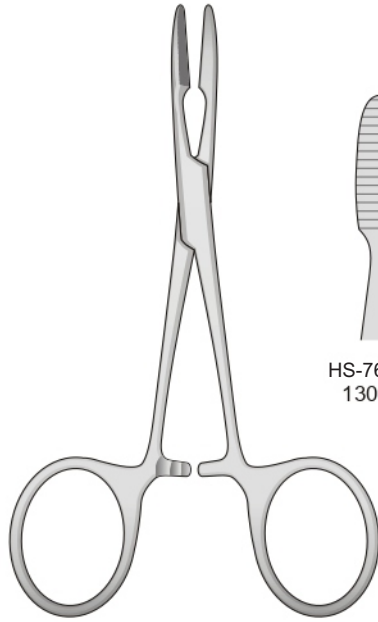

PEAN-MURPHY  
HS-7607

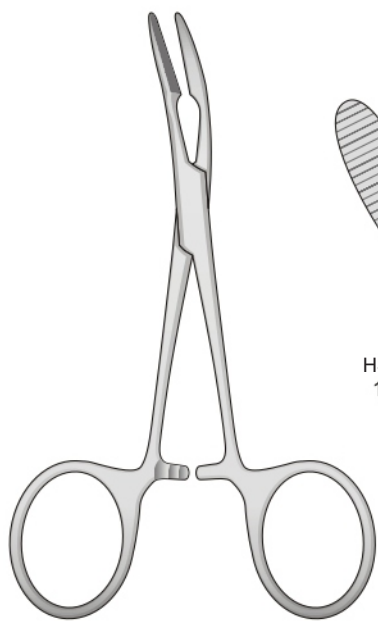
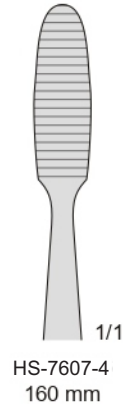
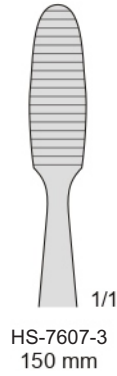
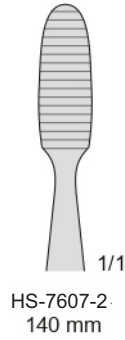
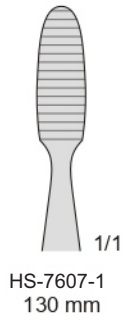

PEAN-MURPHY  
HS-7608

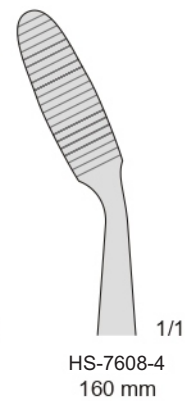
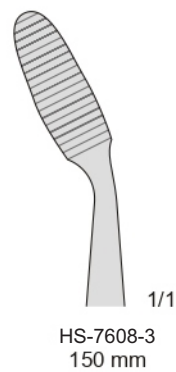
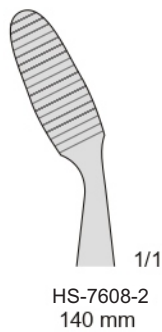
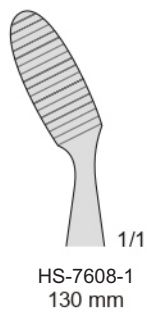

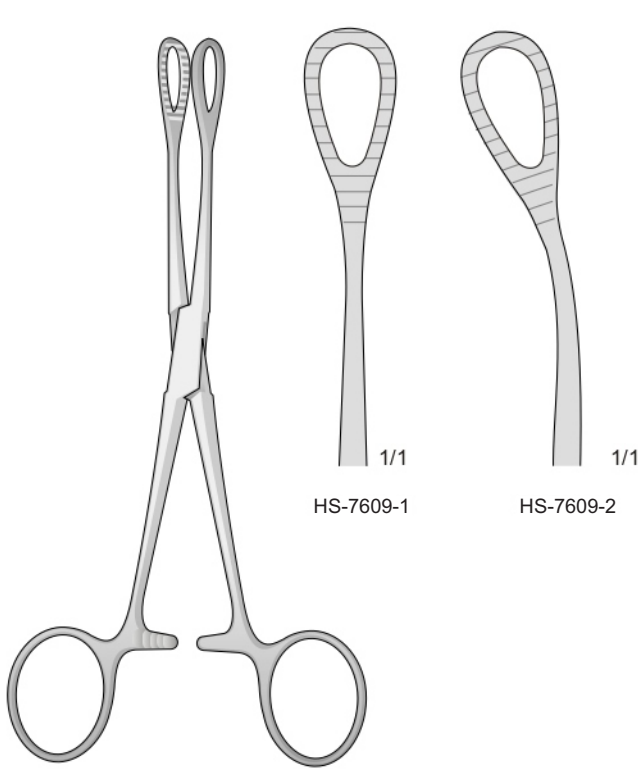

FOERSTER-BALLENGER  
HS-7609  
180 mm

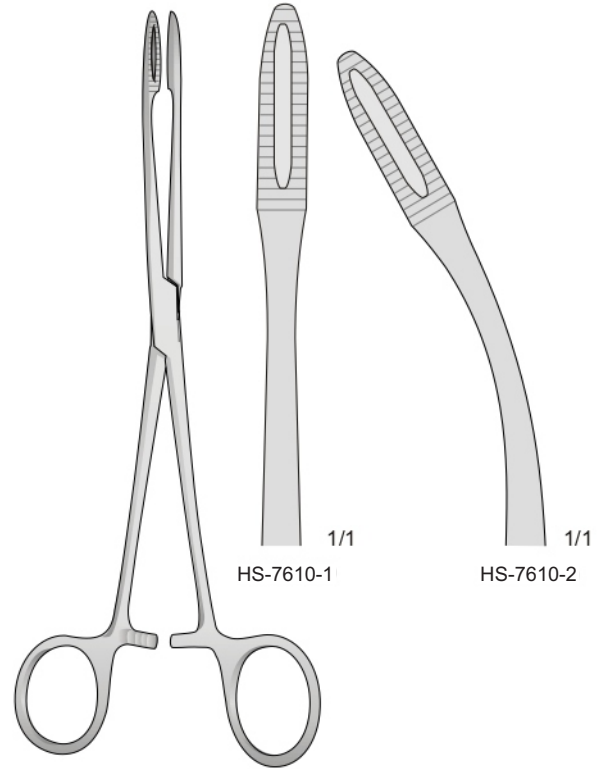

GROSS  
HS-7610  
200 mm

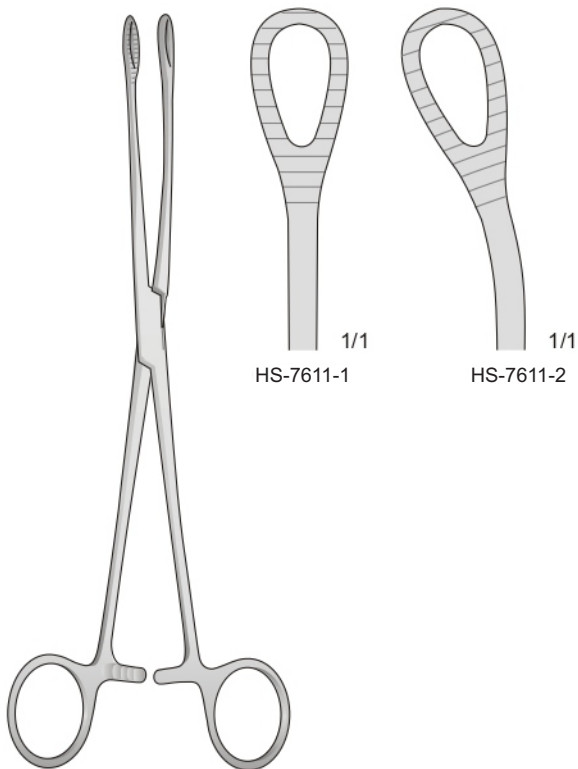

FOERSTER-BALLENGER  
HS-7611  
240 mm

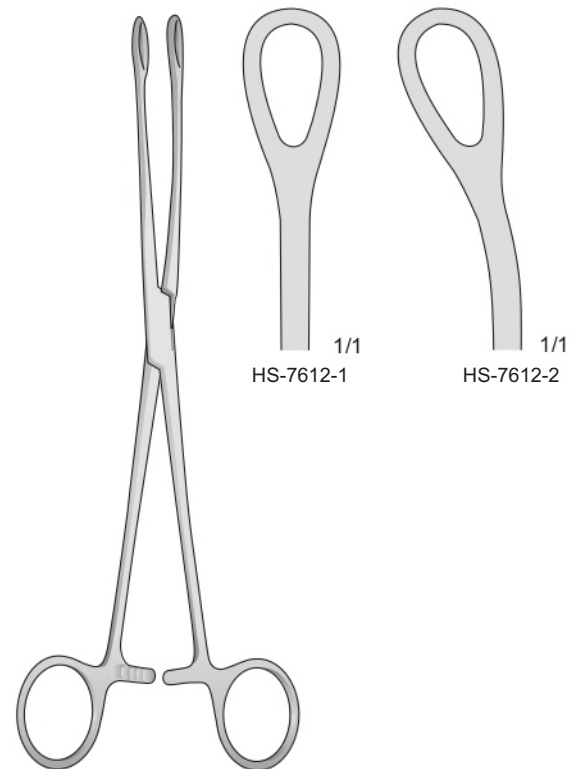

FOERSTER-BALLENGER  
HS-7612  
240 mm



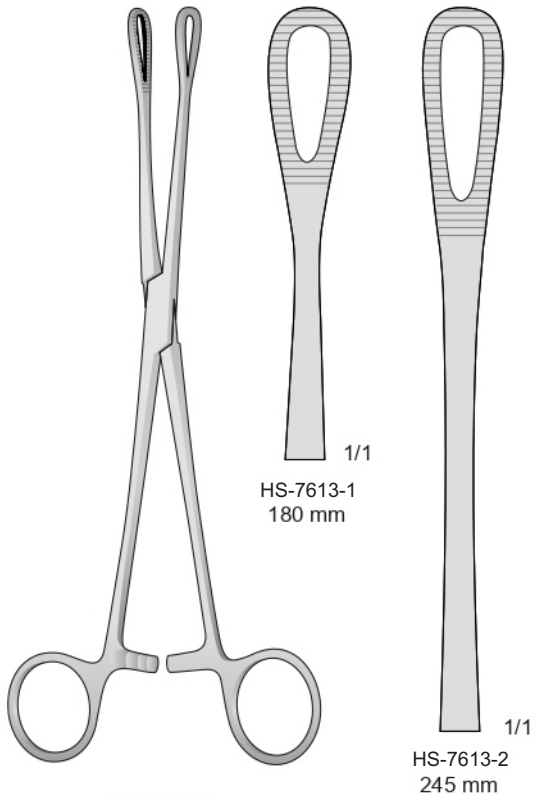

RAMPLEY  
HS-7613

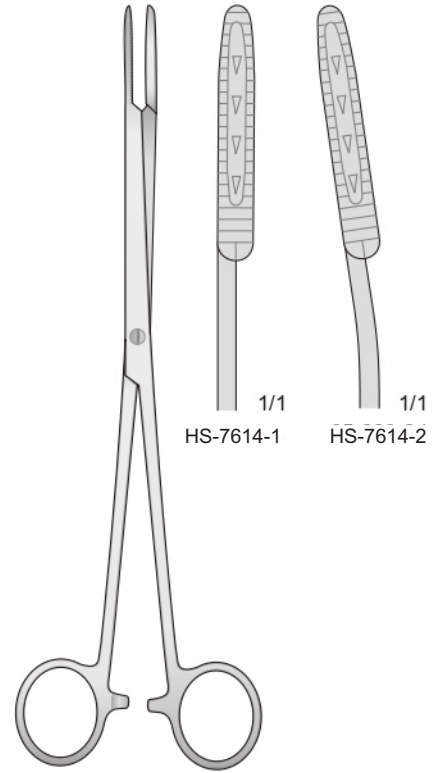

MAIER  
HS-7614  
245 mm

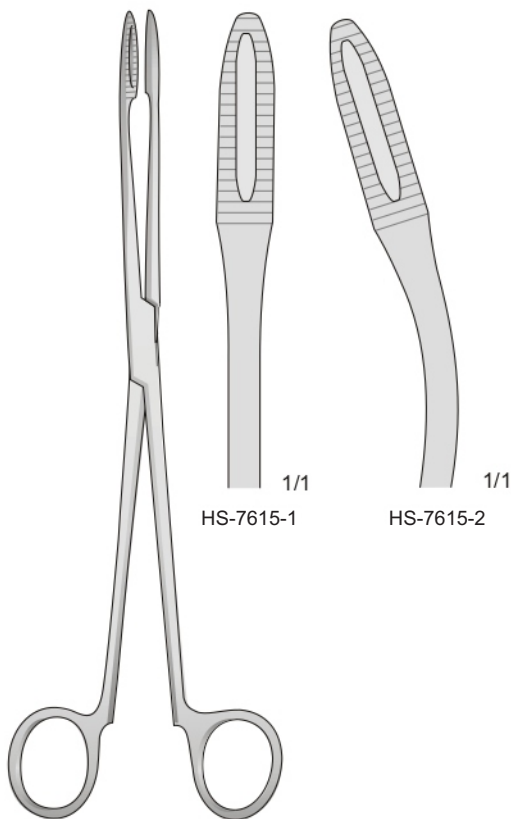

MAIER  
HS-7615  
265 mm

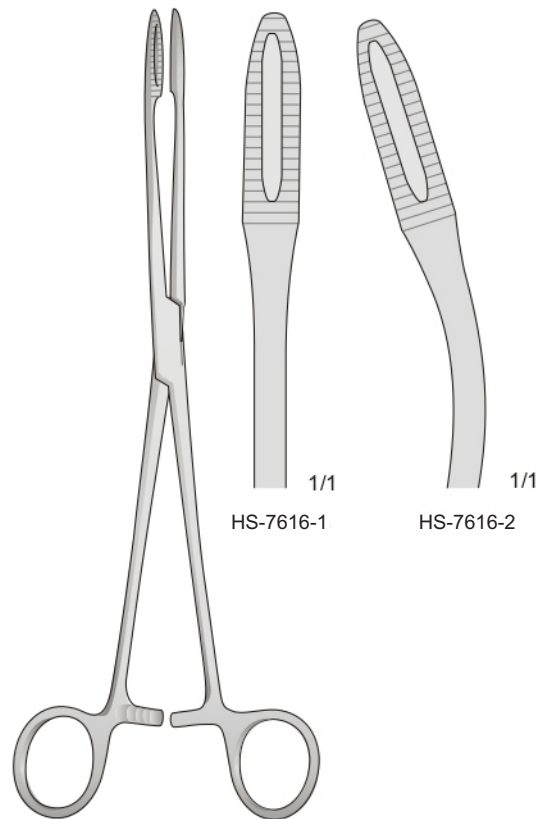

MAIER  
HS-7616  
265 mm



**Tongue Forceps**

Gommini di ricambio 2 pezzi - Pair, Rubber jaws, only  
 Paar, Gummipolster, Allein - Paire, mors en caotchouc, seuls  
 Par, Bocas de goma, sueltas

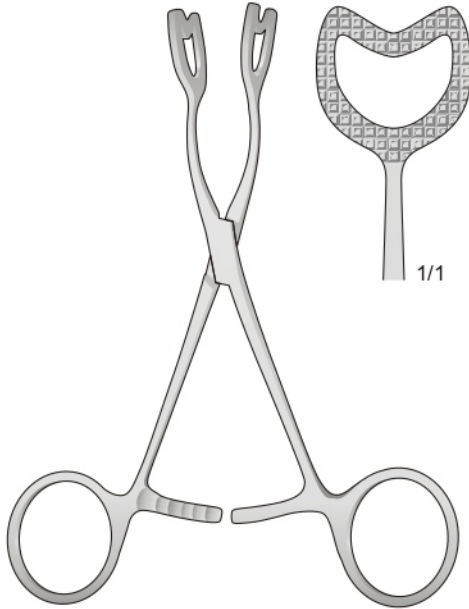

HS-7617  
140 mm

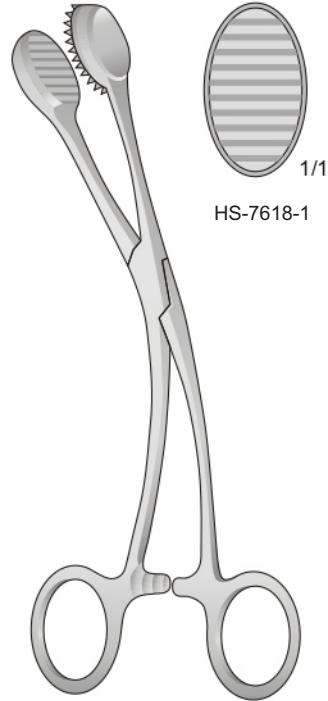

YOUNG  
HS-7618  
160 mm

Gommini di ricambio 2 pezzi - Pair, Rubber jaws, only  
 Paar, Gummipolster, Allein - Paire, mors en caotchouc, seuls  
 Par, Bocas de goma, sueltas

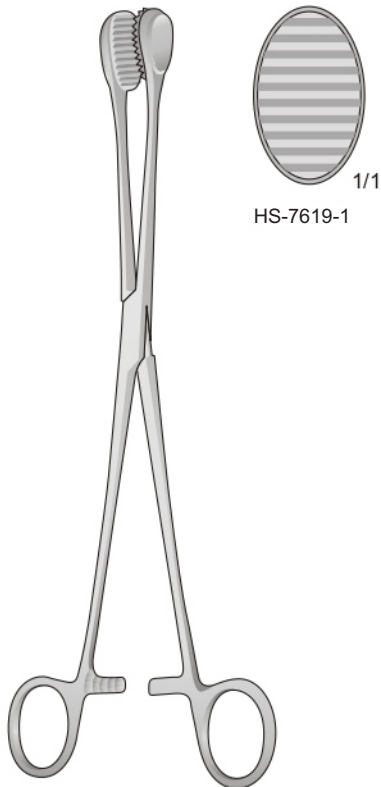

CHILD  
HS-7619  
240 mm

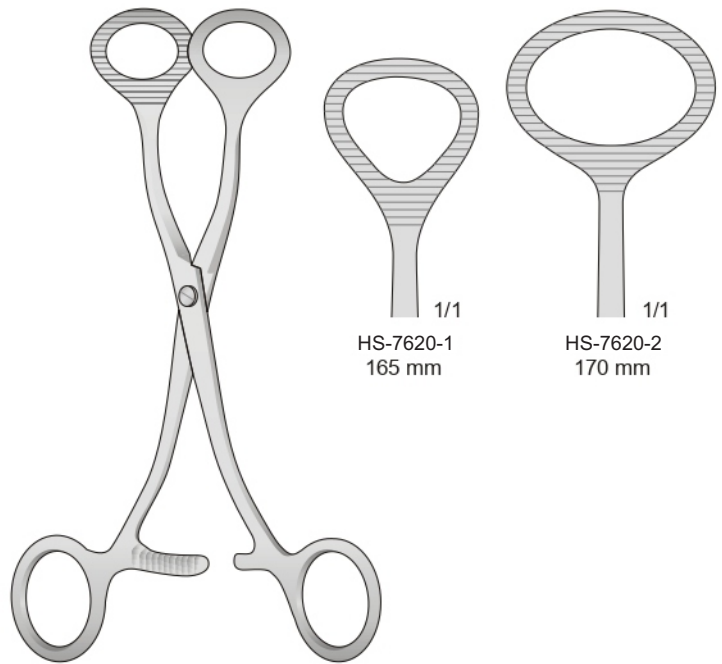

COLLIN  
HS-7620



**Artery Forceps**

Pinza per batuffoli e tamponi  
Cotton swab-sponge holding forceps  
Tupfer-Schwammzangen - Pincés à tampons et éponges  
Pinzas para tampones porta esponjas

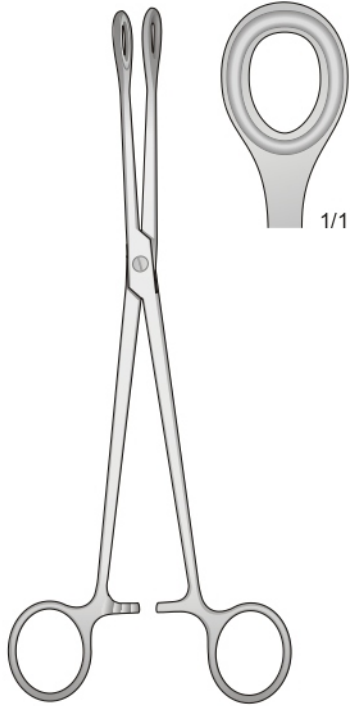

HS-7621  
230 mm

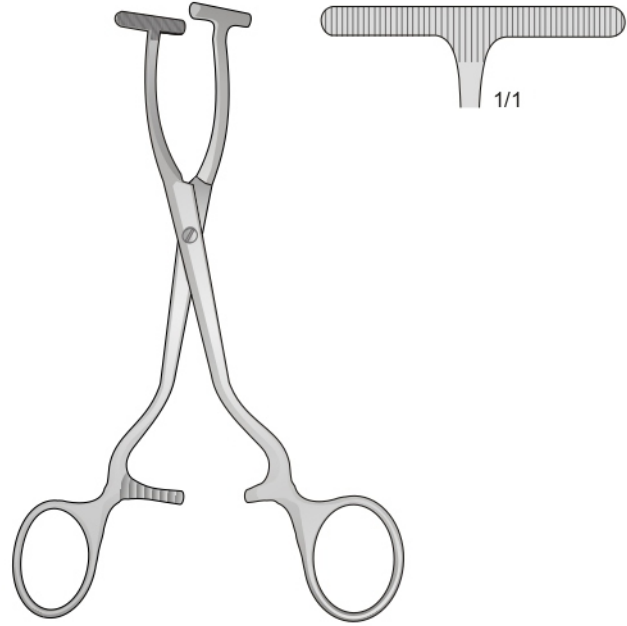

HS-7622  
150 mm

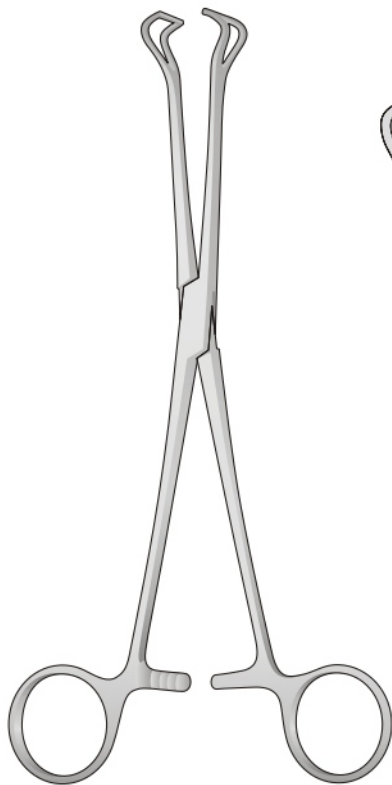

HS-7623  
05-400

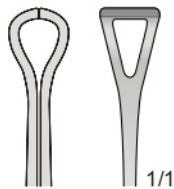

HS-7623-1  
155 mm

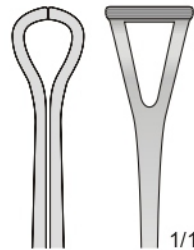

HS-7623-2  
180 mm

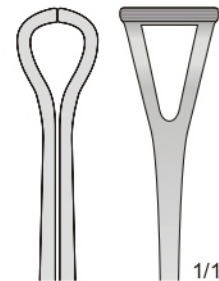

HS-7623-3  
240 mm



**Gum and Tissue Forceps**

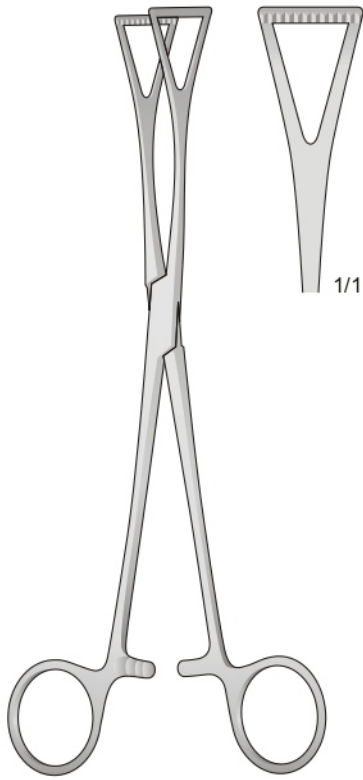

DUVAL  
HS-7624  
185 mm

4 x 5 denti  
4 x 5 teeth  
4 x 5 zähne  
4 x 5 dents  
4 x 5 dientes

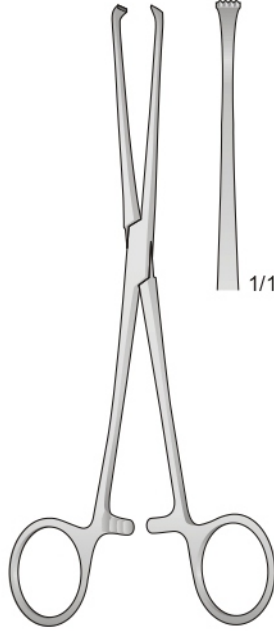



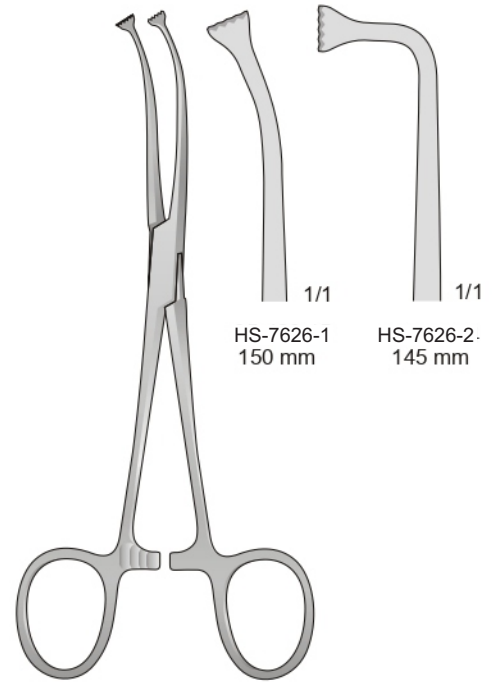

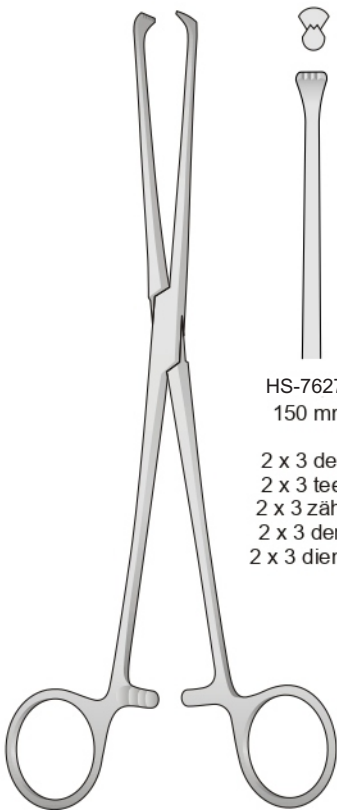

BABY-ALLIS  
HS-7625  
130 mm



ALLIS  
HS-7626



ALLIS  
HS-7627

|   |   |   |   |   |   |   |
|---|---|---|---|---|---|---|
|  |  |  |  |  |  |  |
| 1/1   | 1/1   | 1/1   | 1/1   | 1/1   | 1/1   | 1/1   |
| HS-7627-1<br>150 mm   | HS-7627-2<br>150 mm   | HS-7627-3<br>150 mm   | HS-7627-4<br>160 mm   | HS-7627-5<br>200 mm   | HS-7627-6<br>220 mm   | HS-7627-7<br>250 mm   |
| 2 x 3 denti<br>2 x 3 teeth<br>2 x 3 zähne<br>2 x 3 dents<br>2 x 3 dientes           | 3 x 4 denti<br>3 x 4 teeth<br>3 x 4 zähne<br>3 x 4 dents<br>3 x 4 dientes           | 4 x 5 denti<br>4 x 5 teeth<br>4 x 5 zähne<br>4 x 5 dents<br>4 x 5 dientes           | 5 x 6 denti<br>5 x 6 teeth<br>5 x 6 zähne<br>5 x 6 dents<br>5 x 6 dientes           | 5 x 6 denti<br>5 x 6 teeth<br>5 x 6 zähne<br>5 x 6 dents<br>5 x 6 dientes             | 5 x 6 denti<br>5 x 6 teeth<br>5 x 6 zähne<br>5 x 6 dents<br>5 x 6 dientes             | 5 x 6 denti<br>5 x 6 teeth<br>5 x 6 zähne<br>5 x 6 dents<br>5 x 6 dientes             |



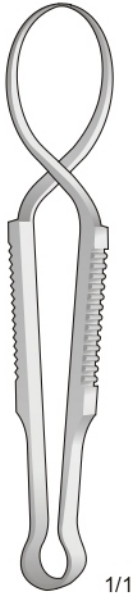

SCHAEDDEL  
 HS-7628  
 85 mm

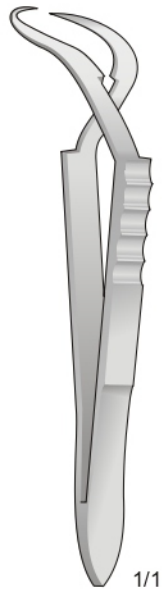

JONES  
 HS-7629  
 90 mm

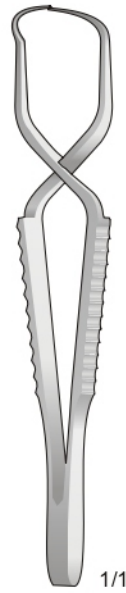

FAURE  
 HS-7630  
 85 mm

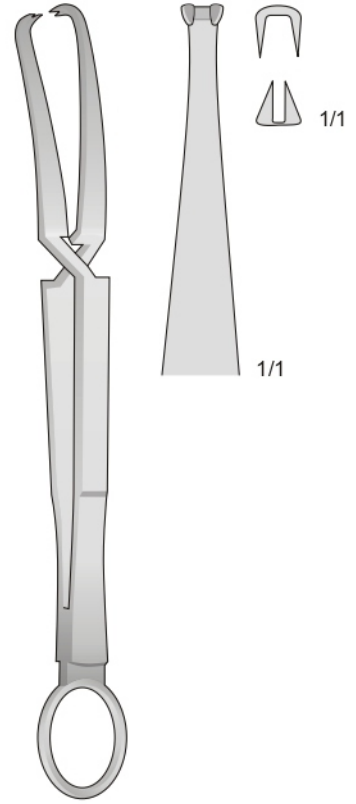

DOYEN  
 HS-7631  
 180 mm

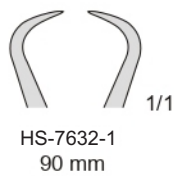
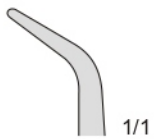

HS-7632-1  
 90 mm

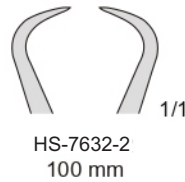

HS-7632-2  
 100 mm

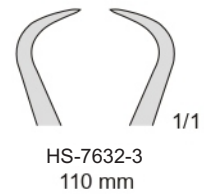

HS-7632-3  
 110 mm

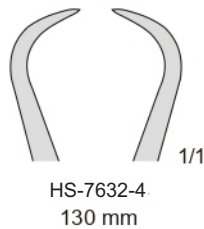

HS-7632-4  
 130 mm

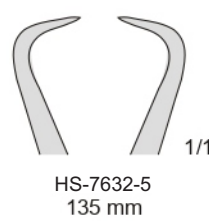

HS-7632-5  
 135 mm

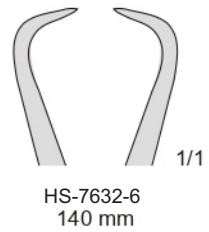

HS-7632-6  
 140 mm

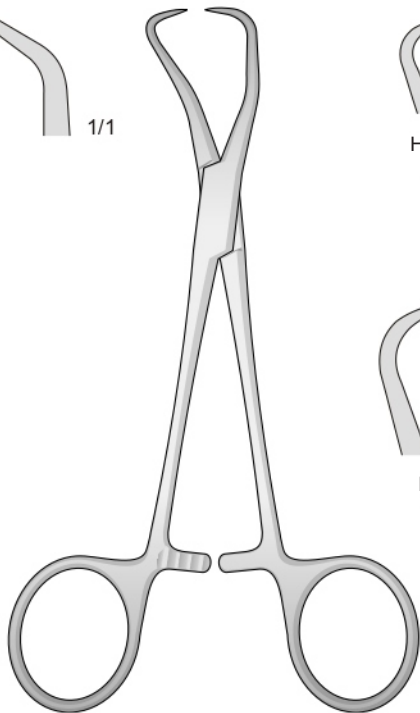

BACKHAUS  
 HS-7632

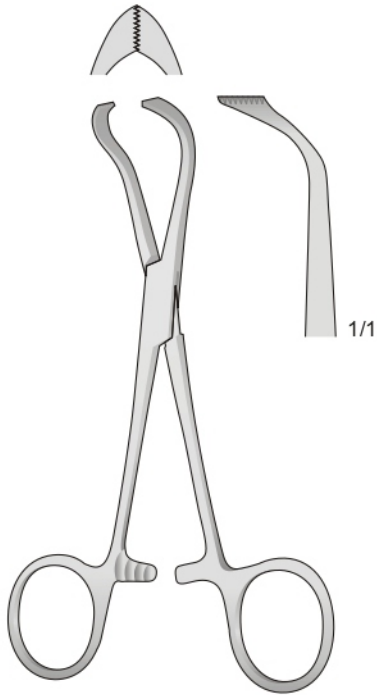

LORNA  
 HS-7633  
 100 mm

Per teli di carta  
 For paper cloths  
 Für Papiertücher  
 Pour Champs en papier

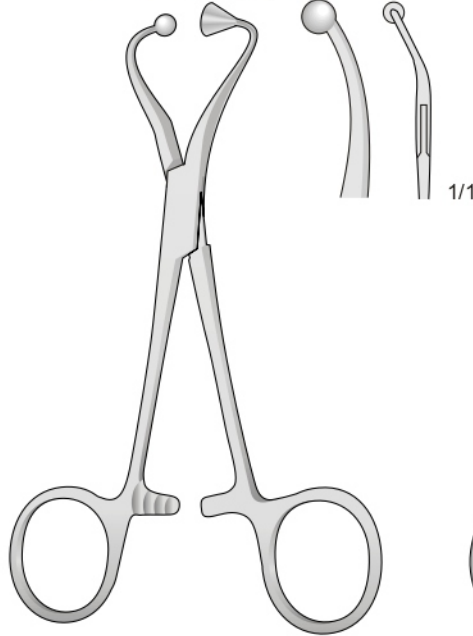

HS-7634  
 115 mm

Per teli di carta  
 For paper cloths  
 Für Papiertücher  
 Pour Champs en papier

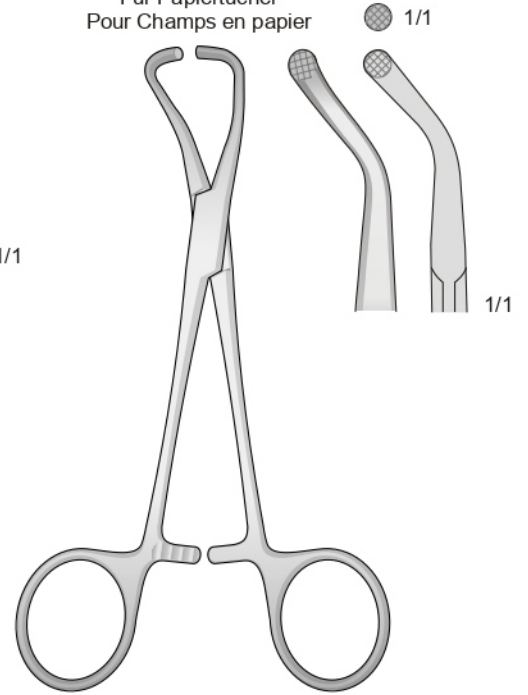

HS-7635  
 130 mm

Per teli di carta  
 For paper cloths  
 Für Papiertücher  
 Pour Champs en papier

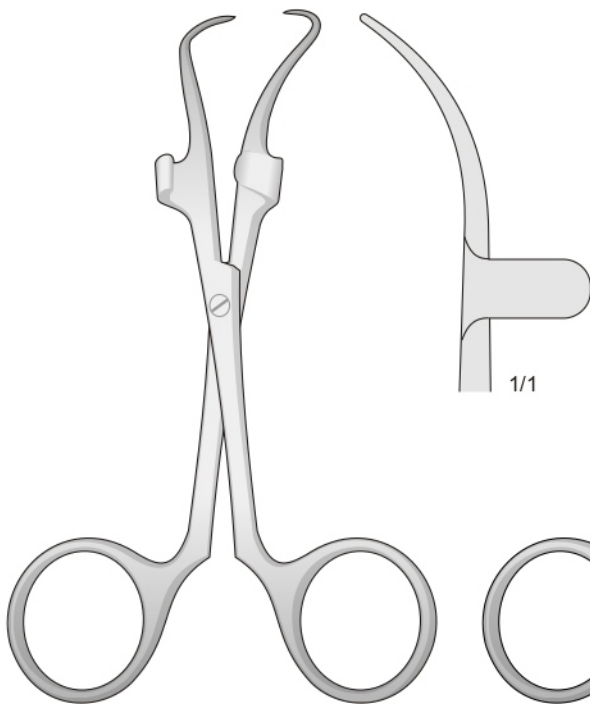

ROBIN  
 HS-7636  
 140 mm

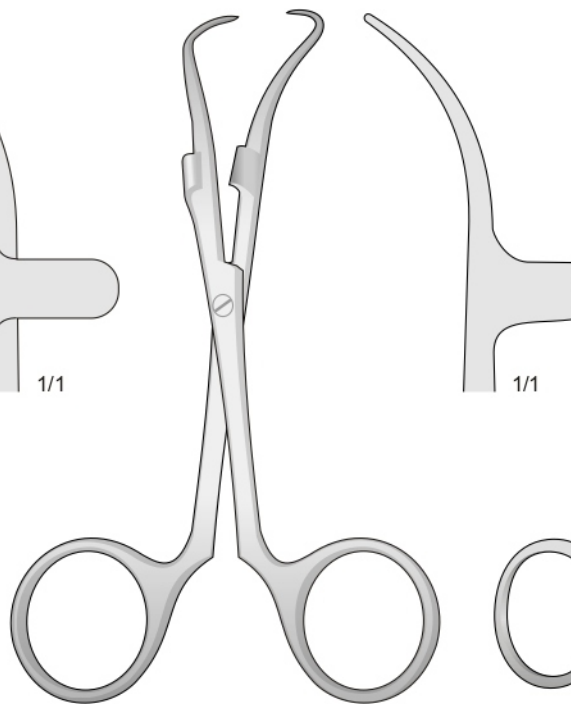

ROBIN  
 HS-7637  
 140 mm

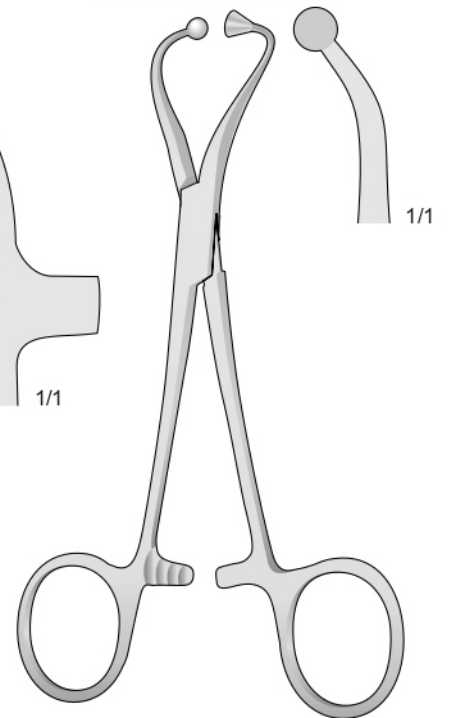

HS-7638  
 140 mm



**Towel Clamps**

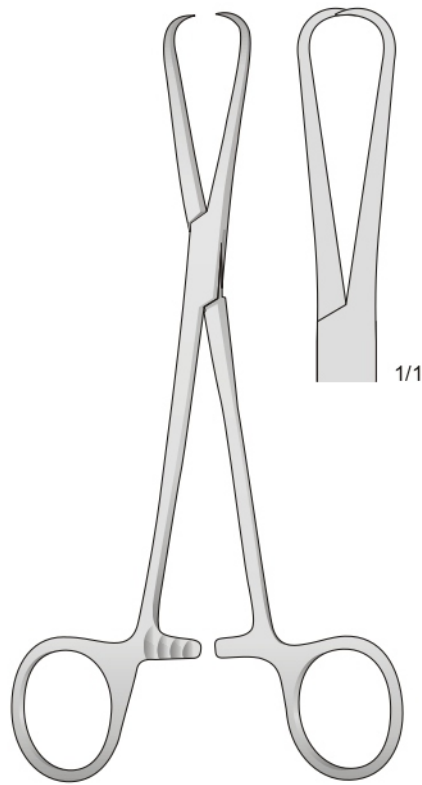

BERNHARD  
HS-7639  
165 mm

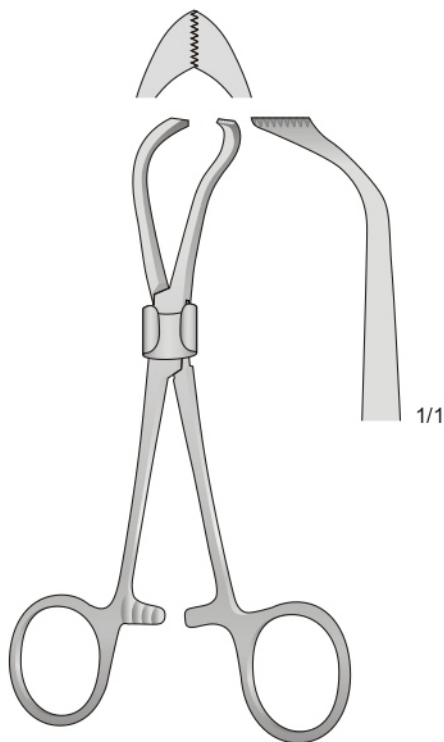

HS-7639-1 Ø 9 mm HS-7639-3 Ø 12 mm  
HS-7639-2 Ø 14 mm HS-7639-4 Ø 17 mm  
100 mm

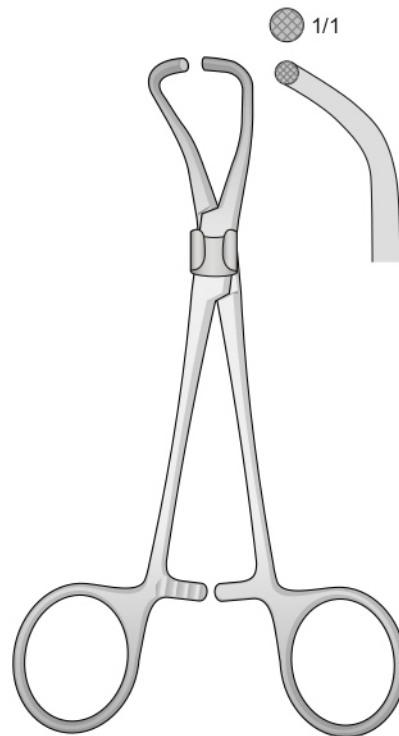

HS-7640-1 Ø 9 mm HS-7640-3 Ø 12 mm  
HS-7640-2 Ø 14 mm HS-7640-4 Ø 17 mm  
130 mm  
HS-7640

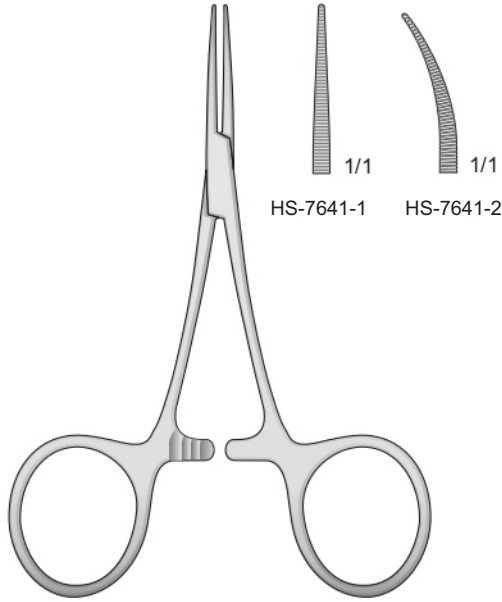

HARTMANN-BABY-MOSQUITO  
HS-7641  
95 mm

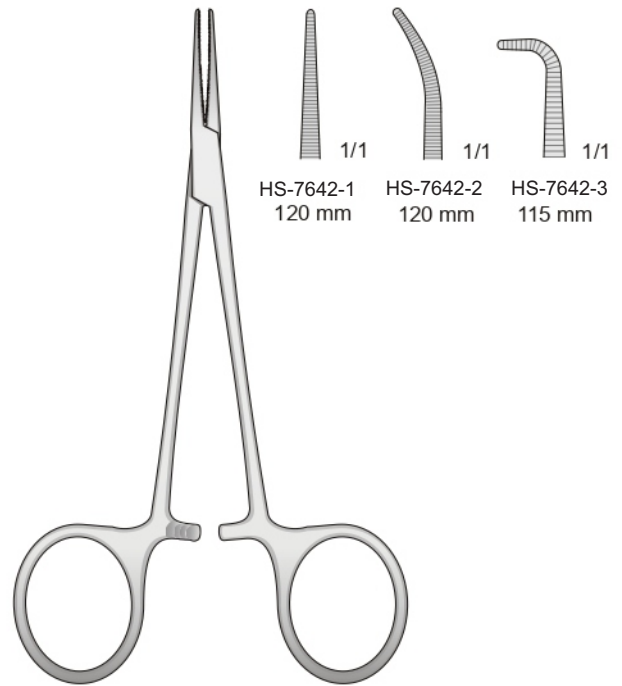

MICRO-HALSTED  
HS-7642

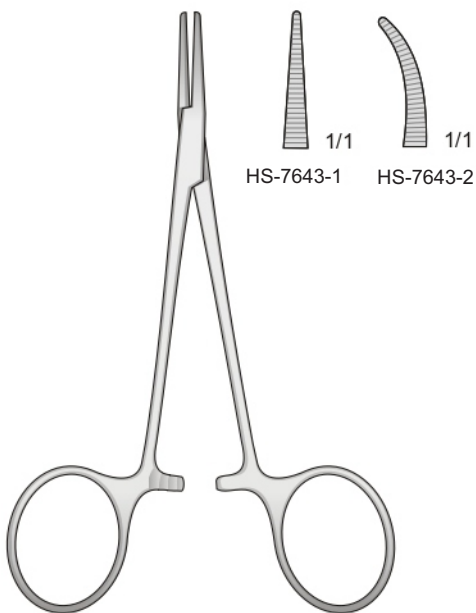

HALSTED-MOSQUITO  
HS-7643  
120 mm

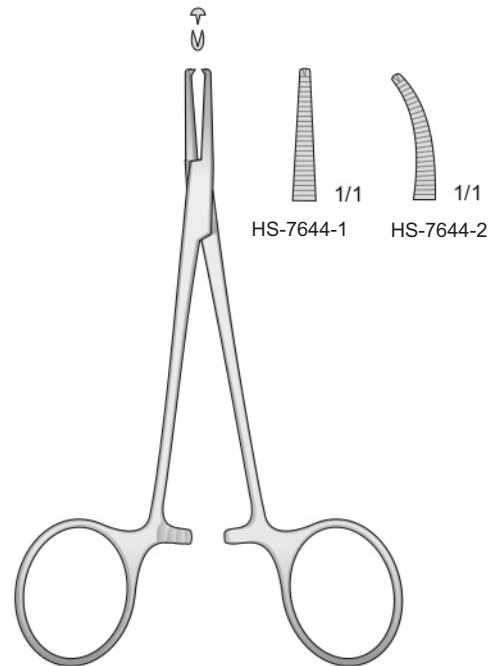

HALSTED-MOSQUITO  
HS-7644  
120 mm



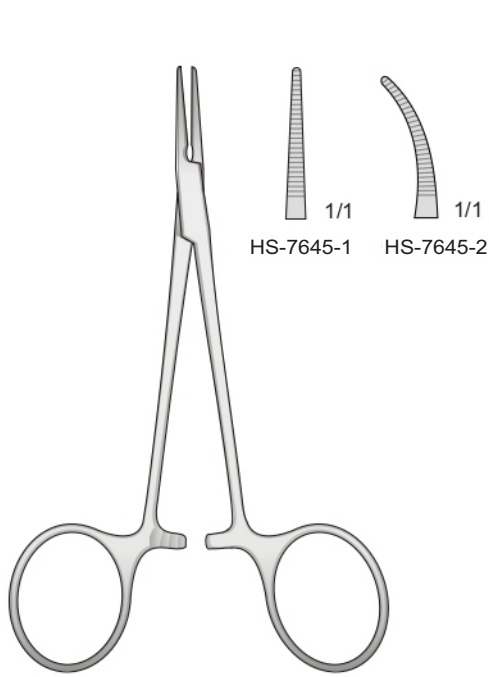

HALSTED  
HS-7645  
125 mm

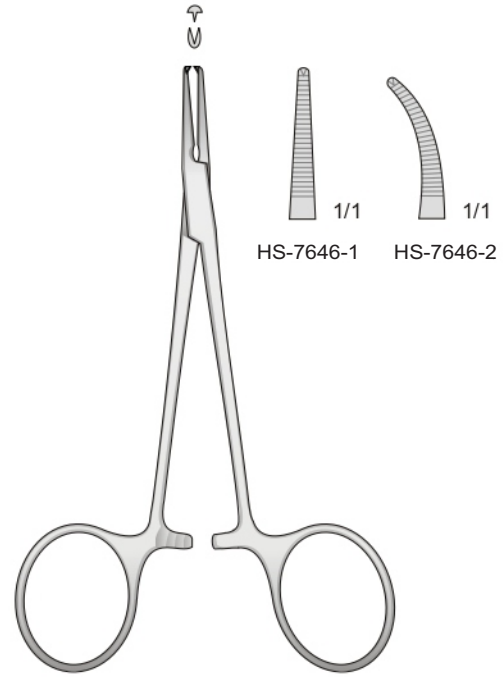

HALSTED  
HS-7646  
125 mm

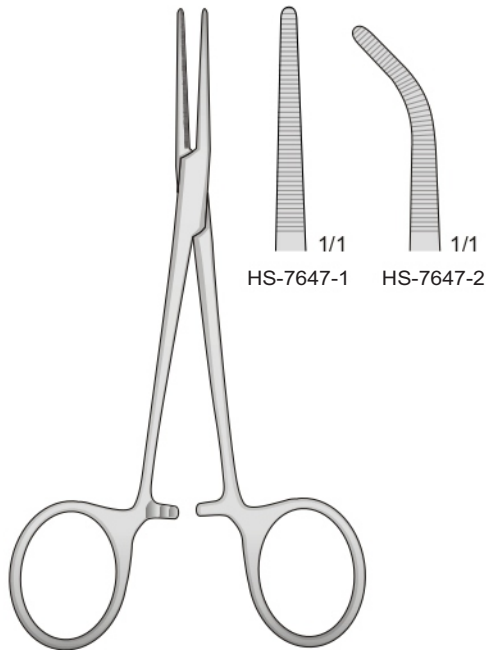

GIDEF  
05-710  
140 mm

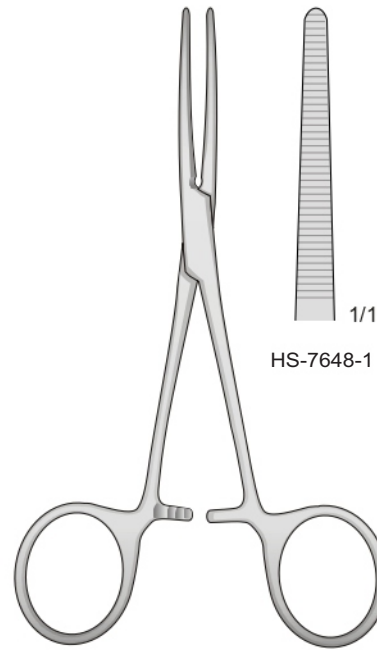

PEAN  
HS-7648  
140 mm

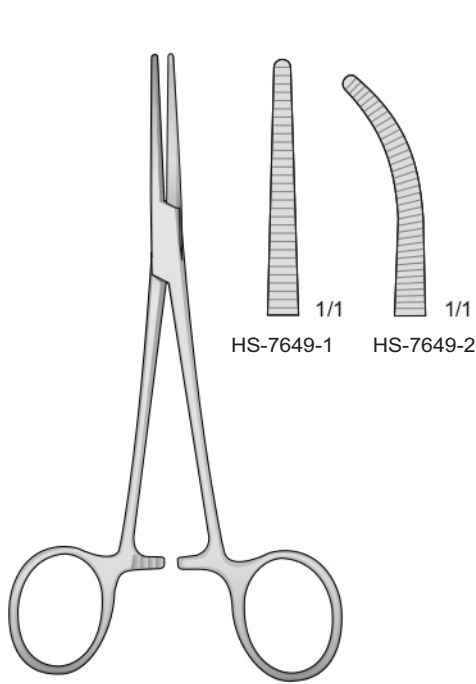

CRILE  
HS-7649  
140 mm

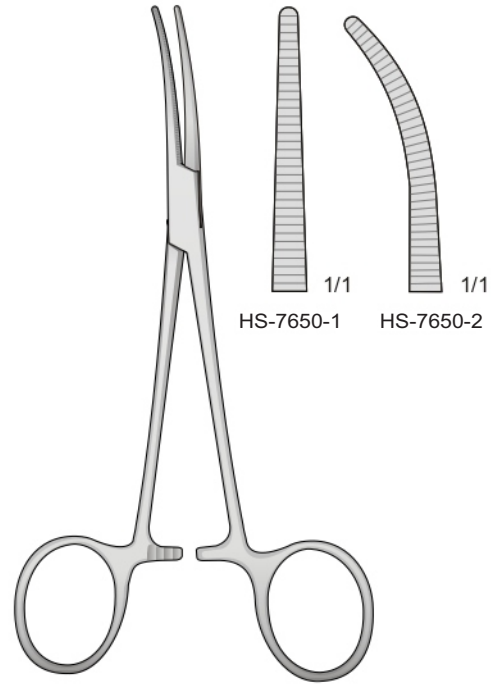

CRILE  
HS-7650  
160 mm

Curve sul lato  
Curved to side  
Seitwärts gebogen  
Courbes latérales  
Curvas laterales

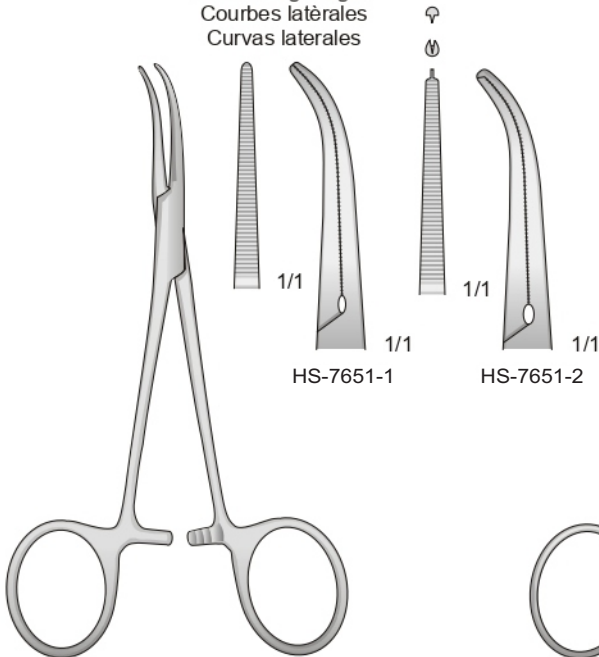

DANDY  
HS-7651  
140 mm

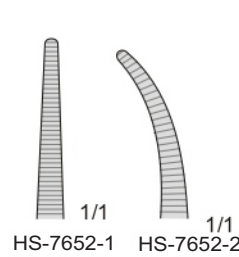

LERICHE  
HS-7652  
150 mm

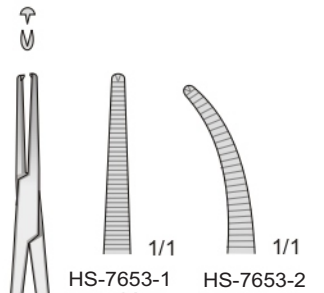

LERICHE  
HS-7653  
150 mm

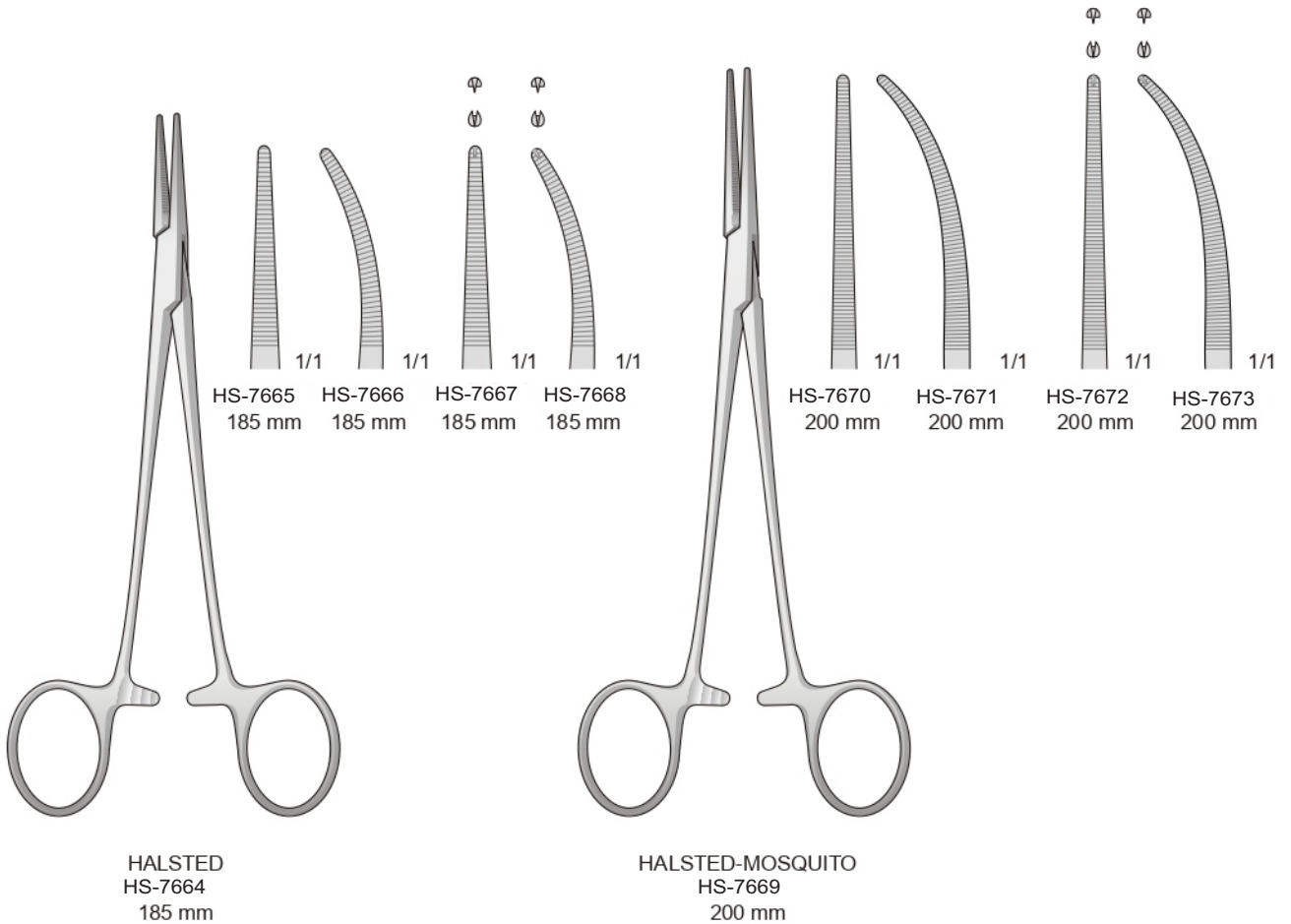
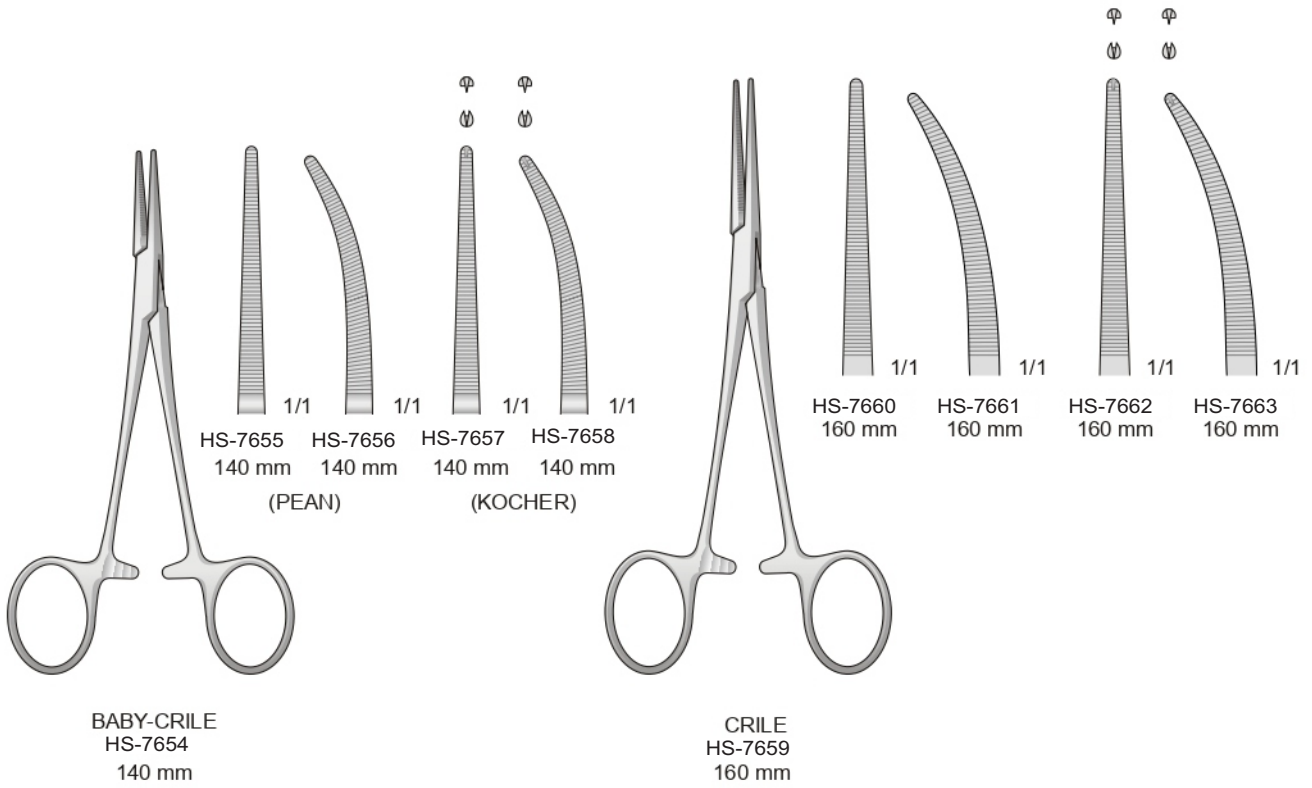

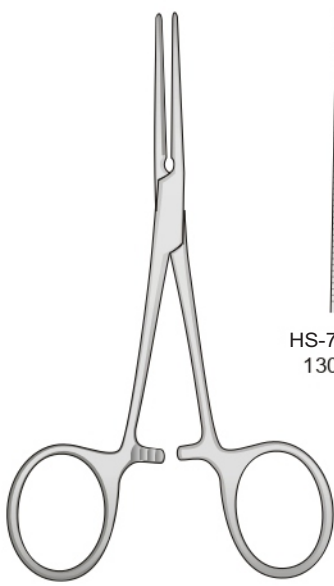

PEAN  
HS-7674

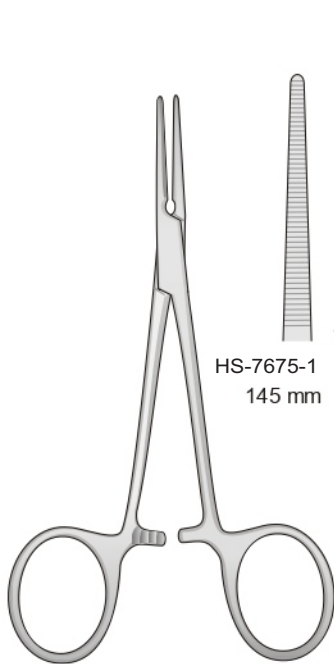
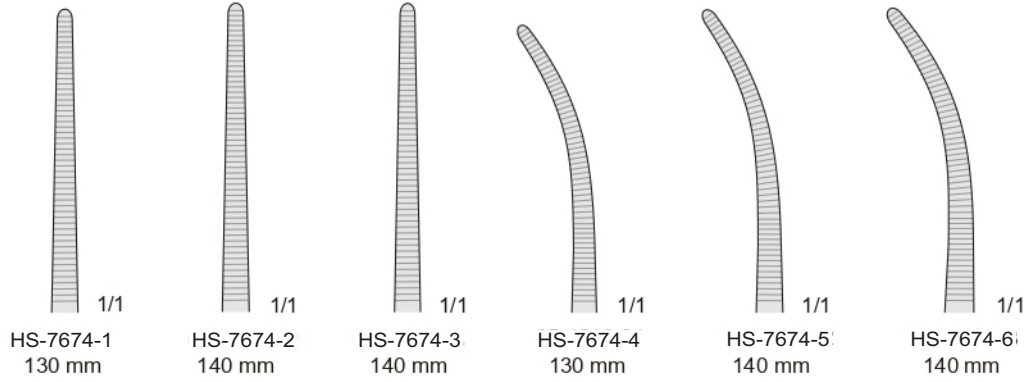

PEAN  
HS-7675

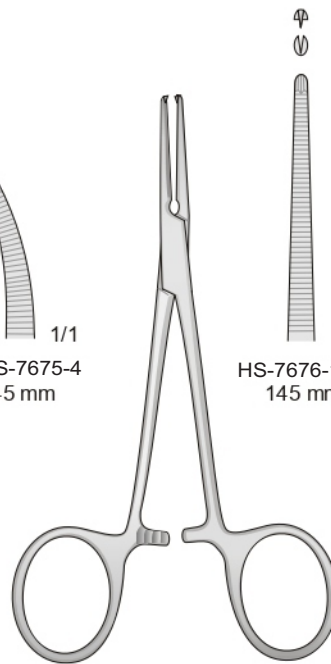
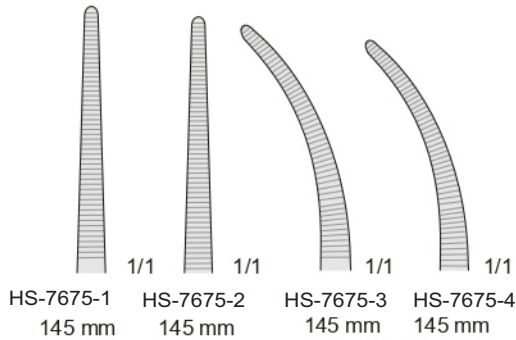

KOCHER  
HS-7676

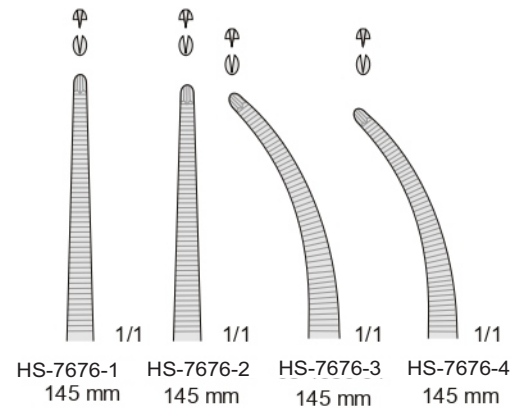



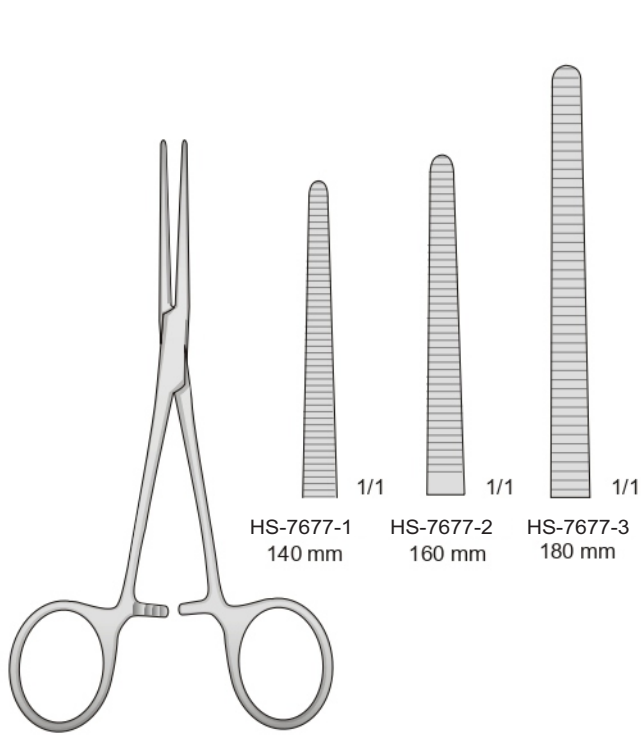

ROCHESTER-PEAN  
HS-7677

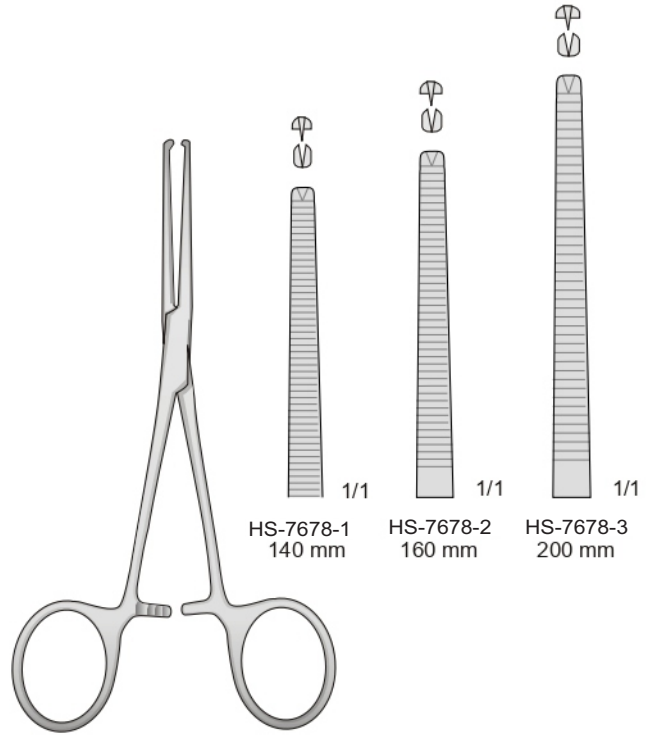

KOCHER-OCHSNER  
HS-7678

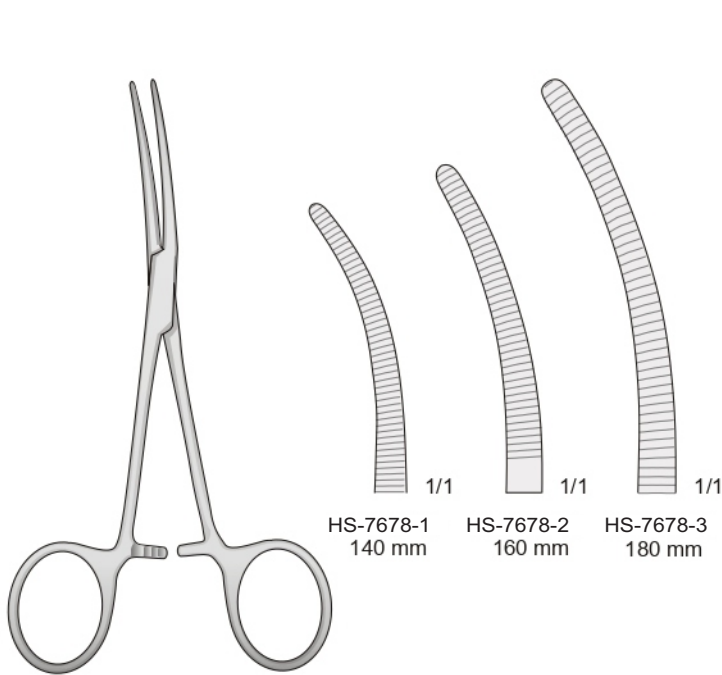

ROCHESTER-PEAN  
HS-7678

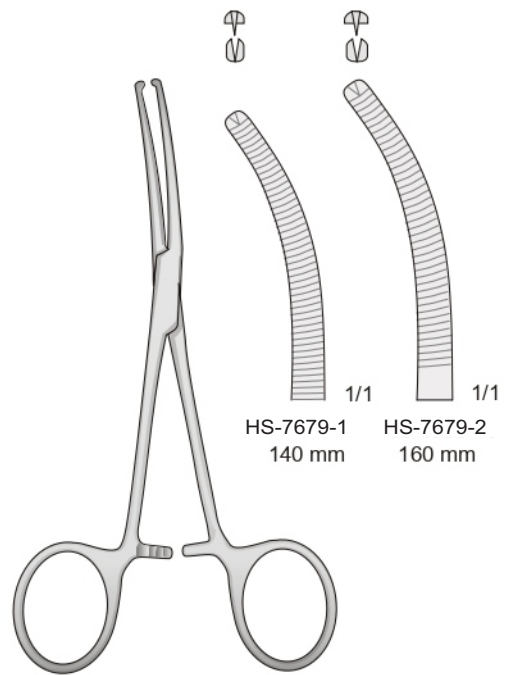

KOCHER-OCHSNER  
HS-7679

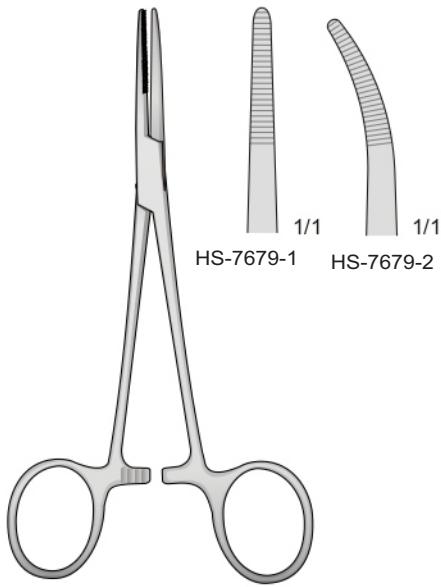

**KELLY**  
HS-7679  
140 mm

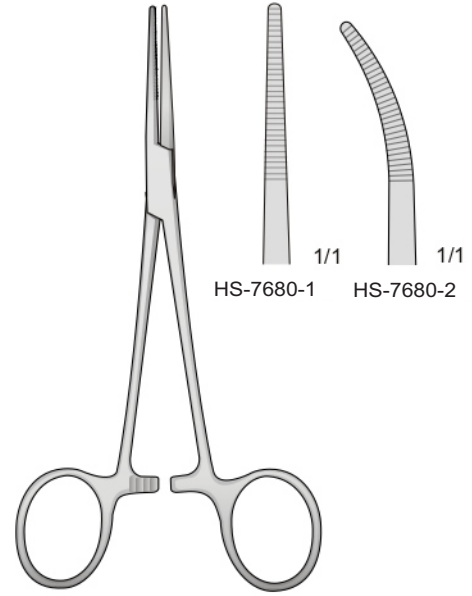

**KELLY**  
HS-7680  
140 mm

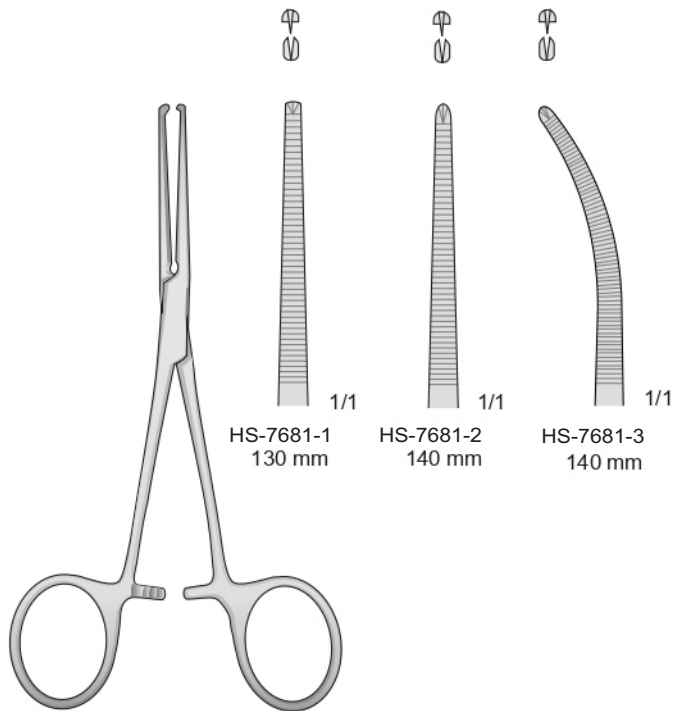

**KOCHER**  
HS-7681

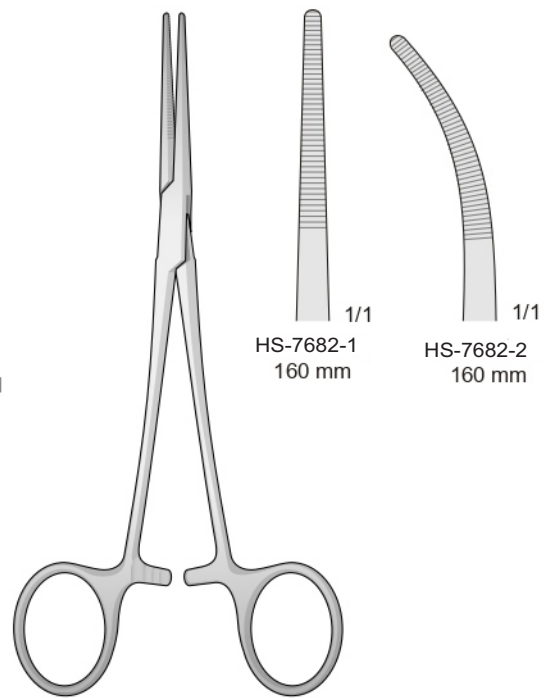

**RANKIN**  
HS-7682

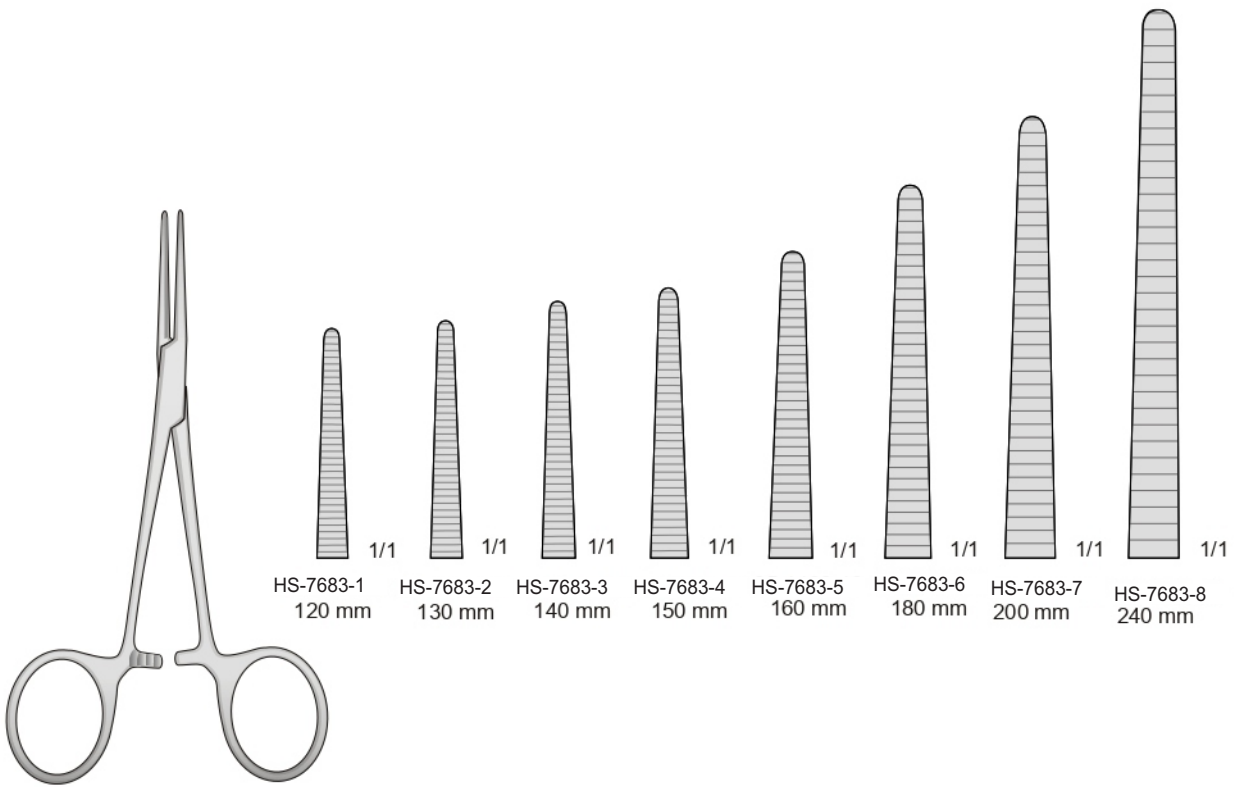

PEAN  
HS-7683

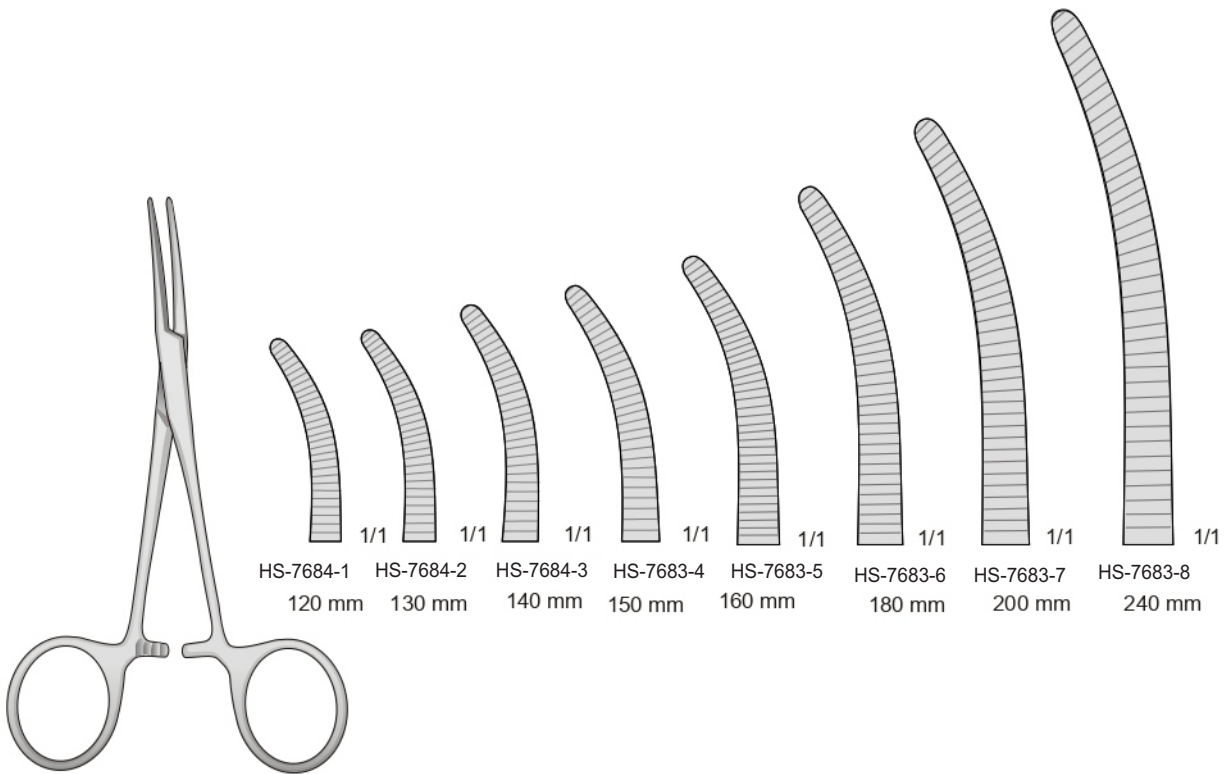

PEAN  
HS-7684

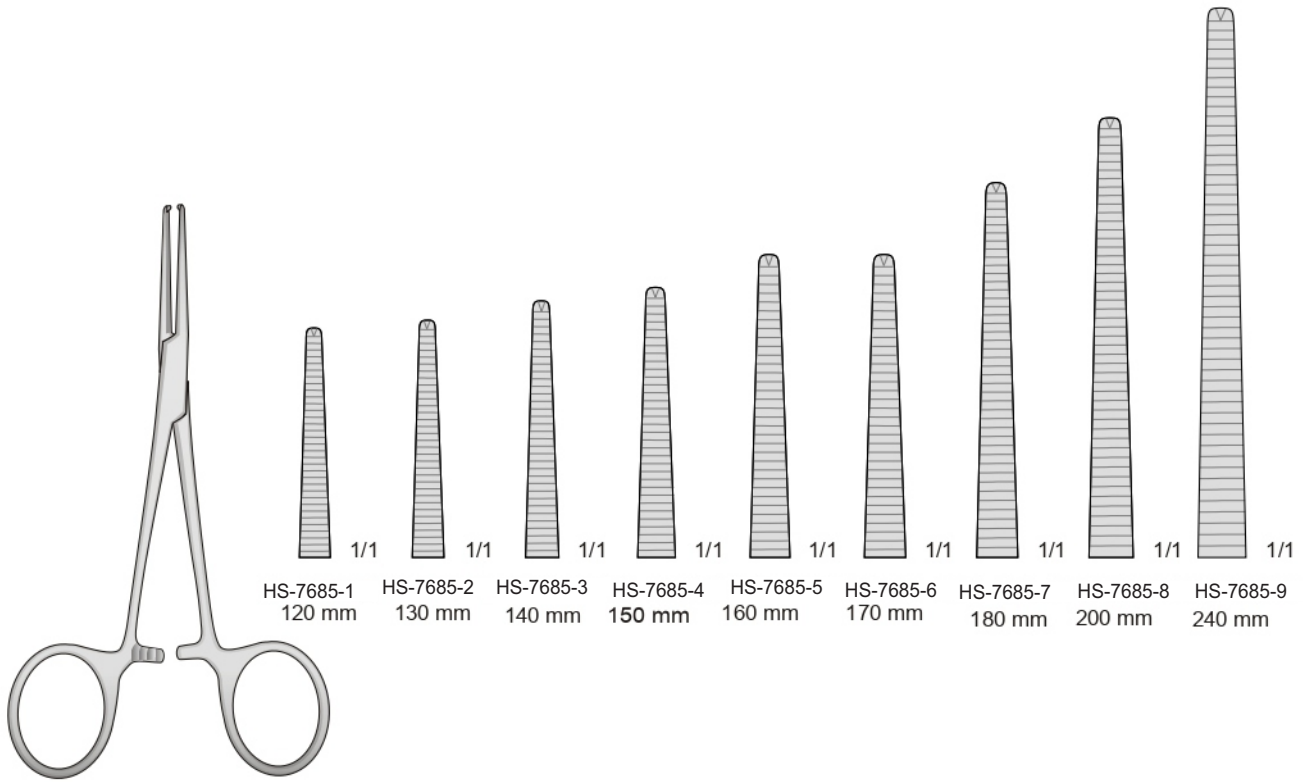

KOCHER  
HS-7685

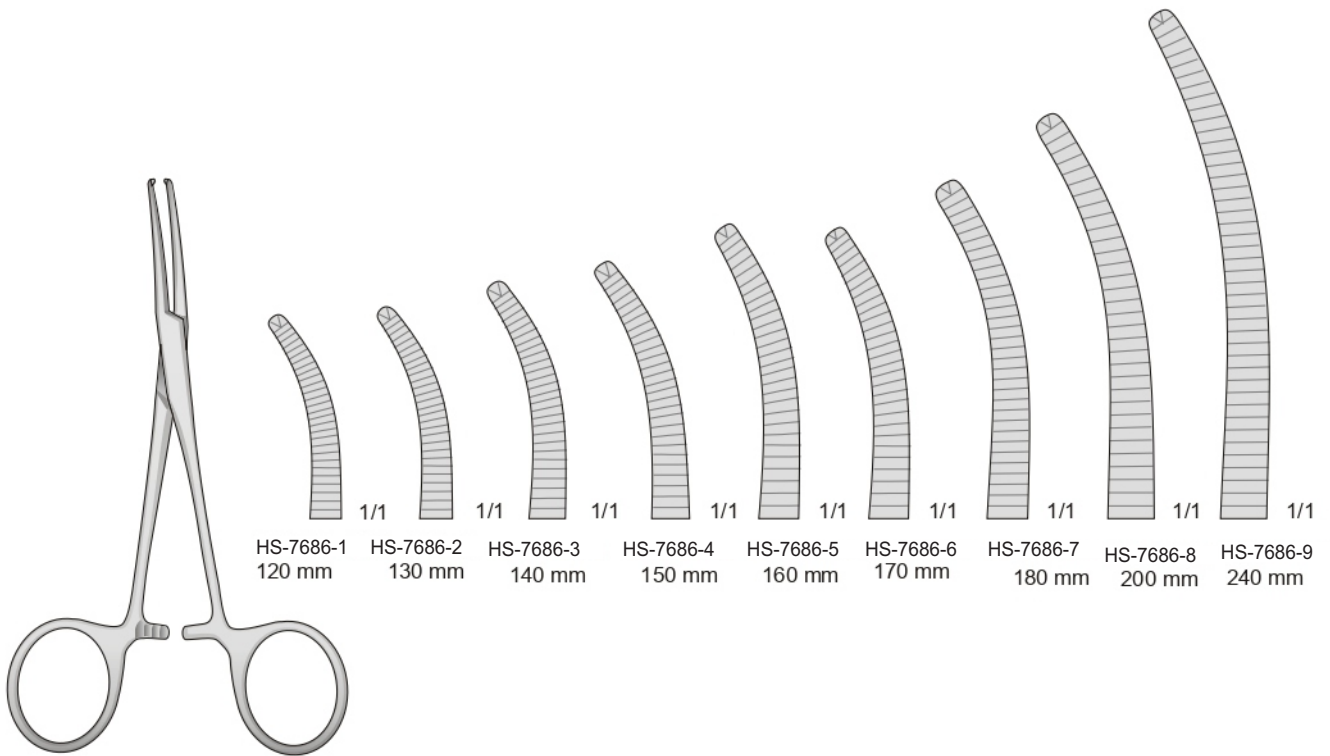

KOCHER  
HS-7686



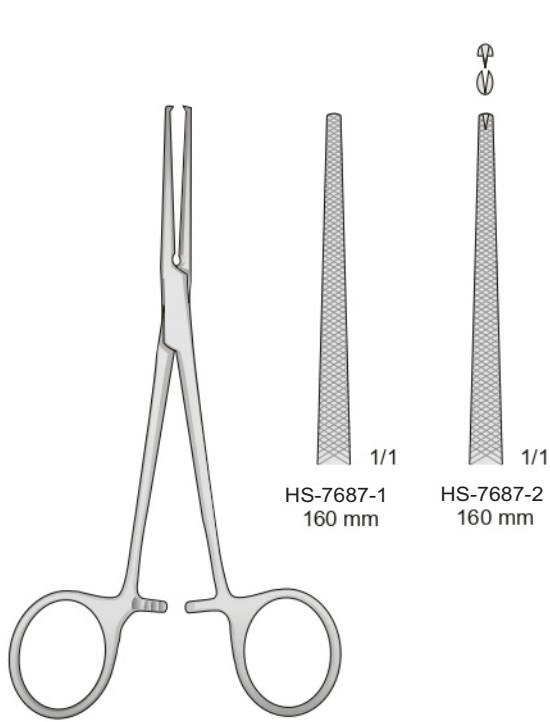

DIXON-LOVELACE  
HS-7687

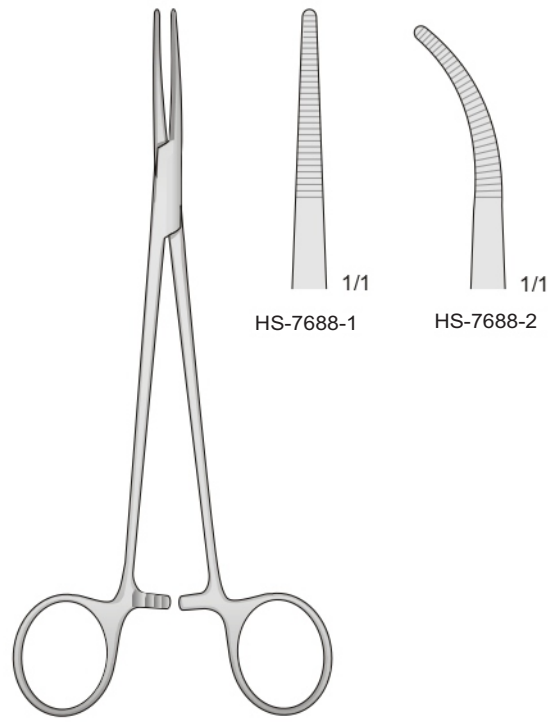

BIRKETT  
HS-7688  
180 mm

Pinza per peritoneo - Peritoneal clamps forceps  
Pritoneum klemmen - Pincés-camps pour les péritoine  
Pinzas-clamps para peritoneo

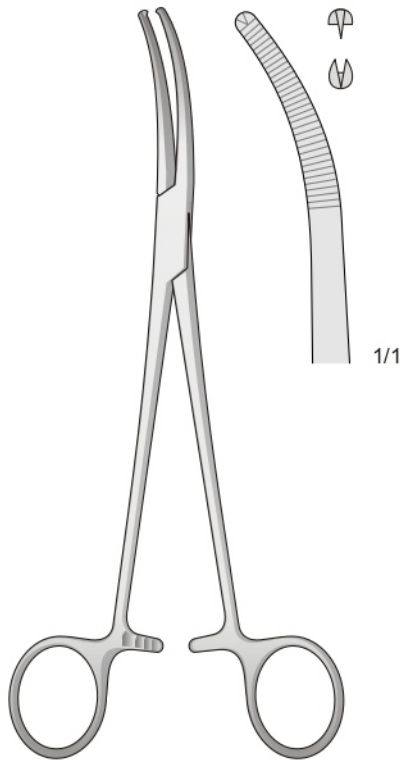

MIKULICZ  
HS-7689  
190 mm

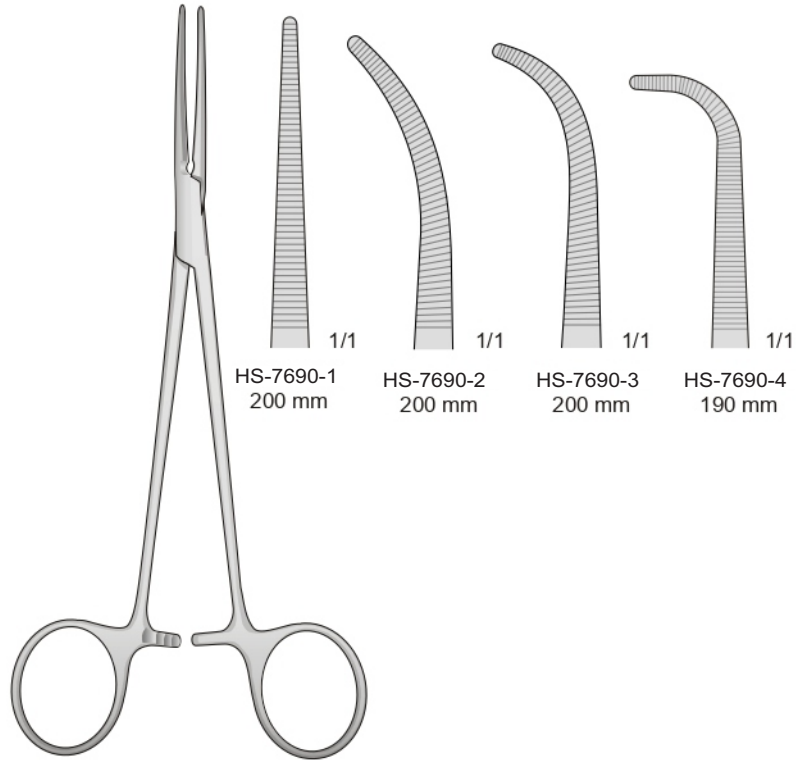

HEISS  
HS-7690

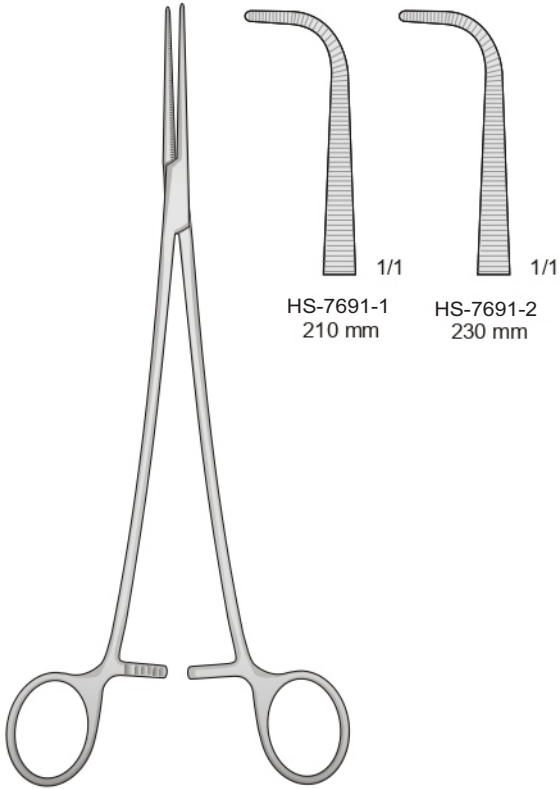

BENGOLEA  
HS-7691

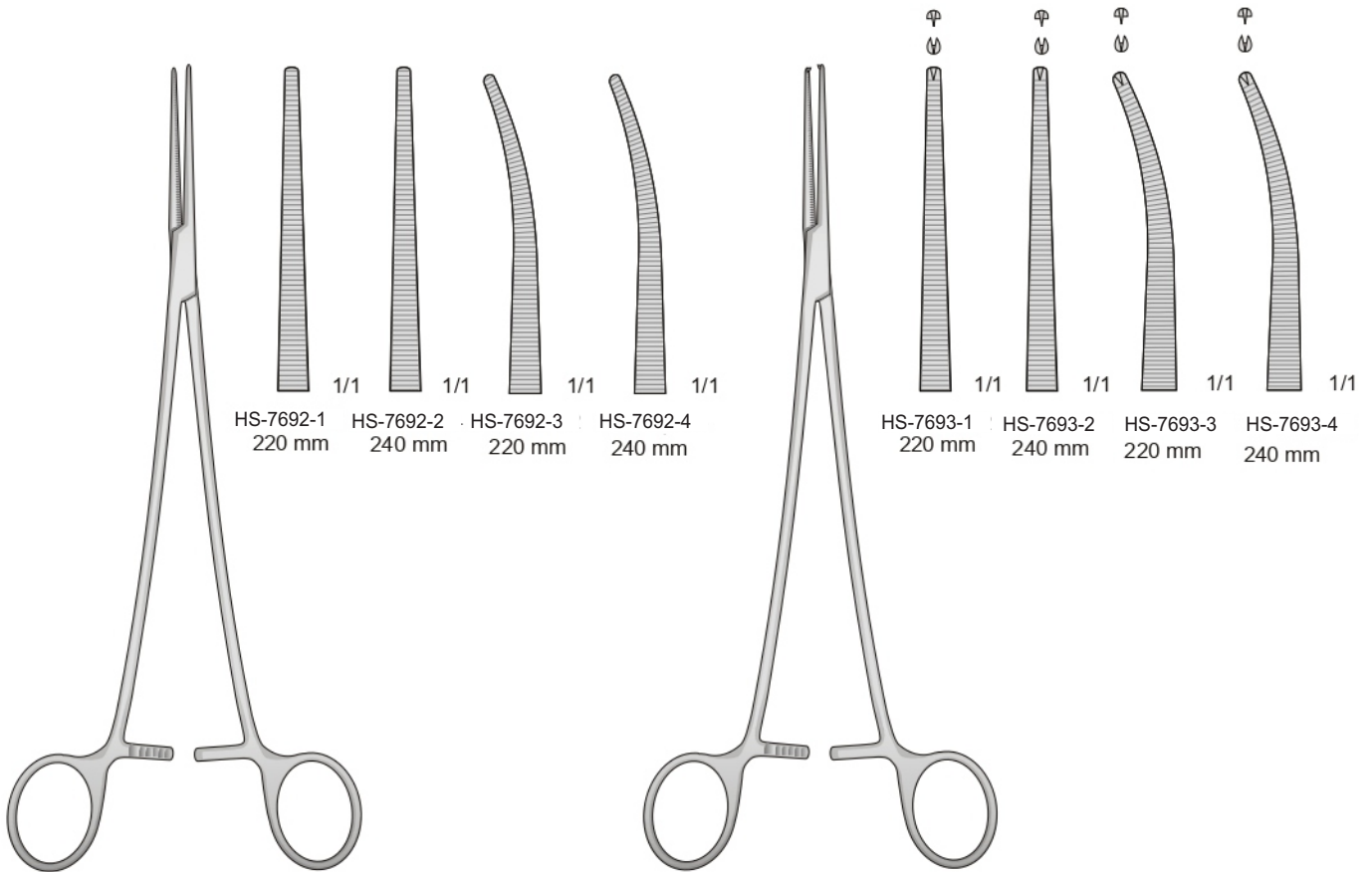

BENGOLEA  
HS-7692

BENGOLEA  
HS-7693

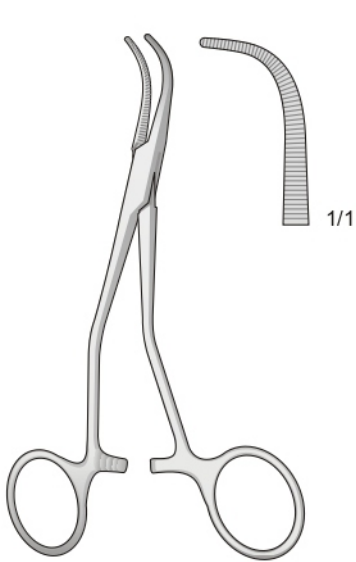

HS-7694  
130 mm

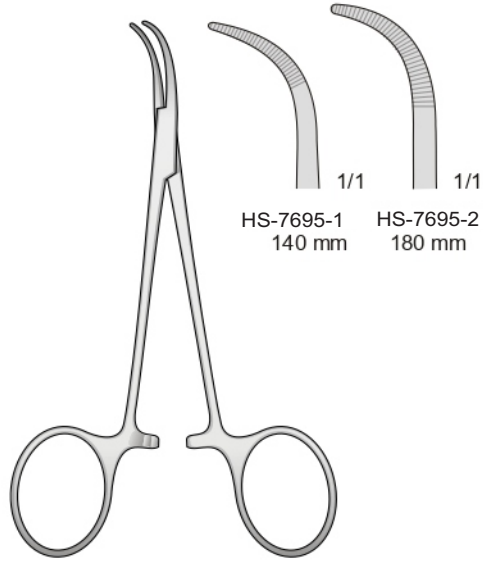

BABY-MIXTER  
HS-7695

HS-7695-1  
140 mm

HS-7695-2  
180 mm

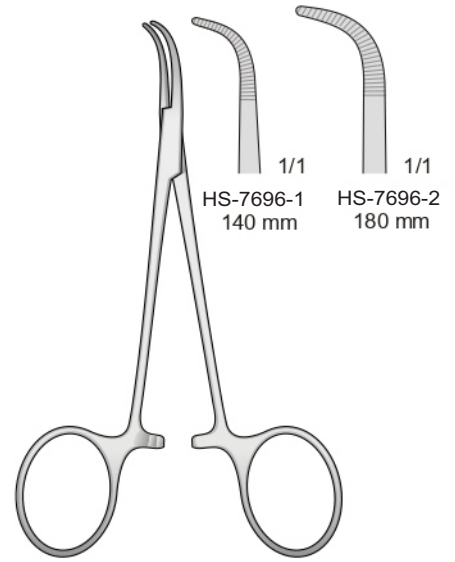

BABY-ADSON  
HS-7696

HS-7696-1  
140 mm

HS-7696-2  
180 mm

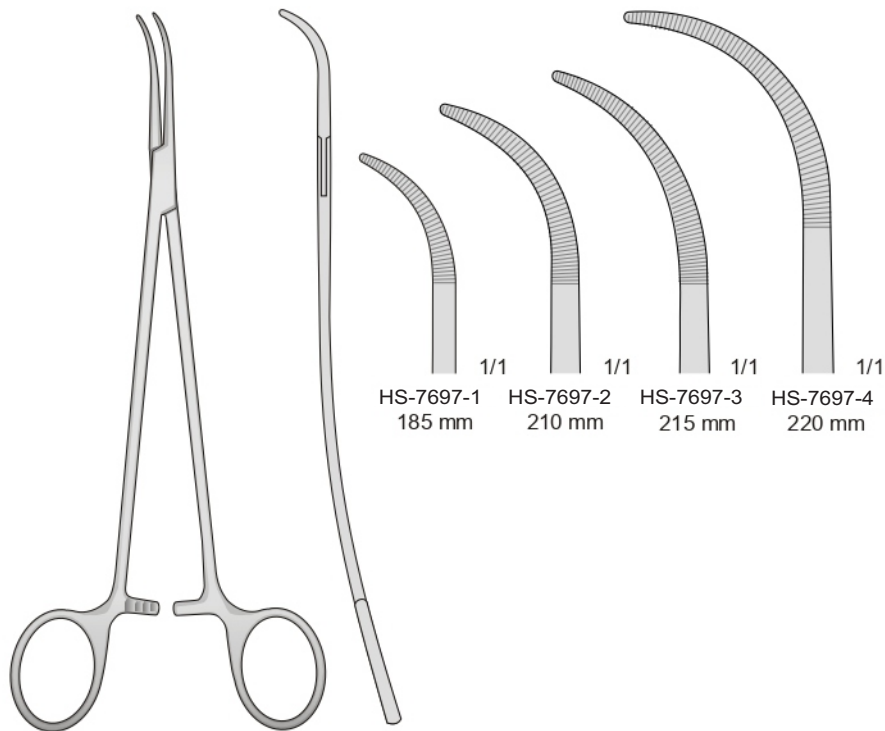

HS-7697

HS-7697-1  
185 mm

HS-7697-2  
210 mm

HS-7697-3  
215 mm

HS-7697-4  
220 mm

Passafili

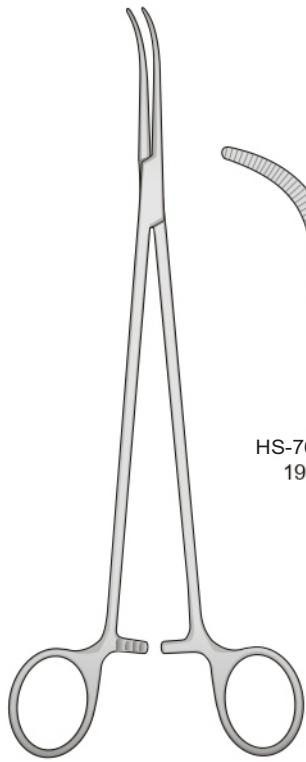

OVERHOLT-GEISSENDORFER  
HS-7698

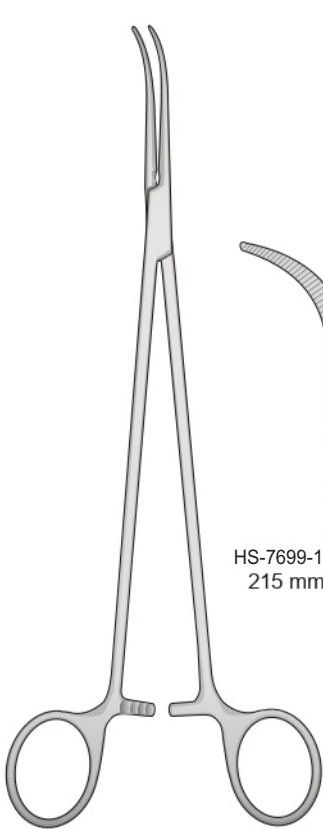
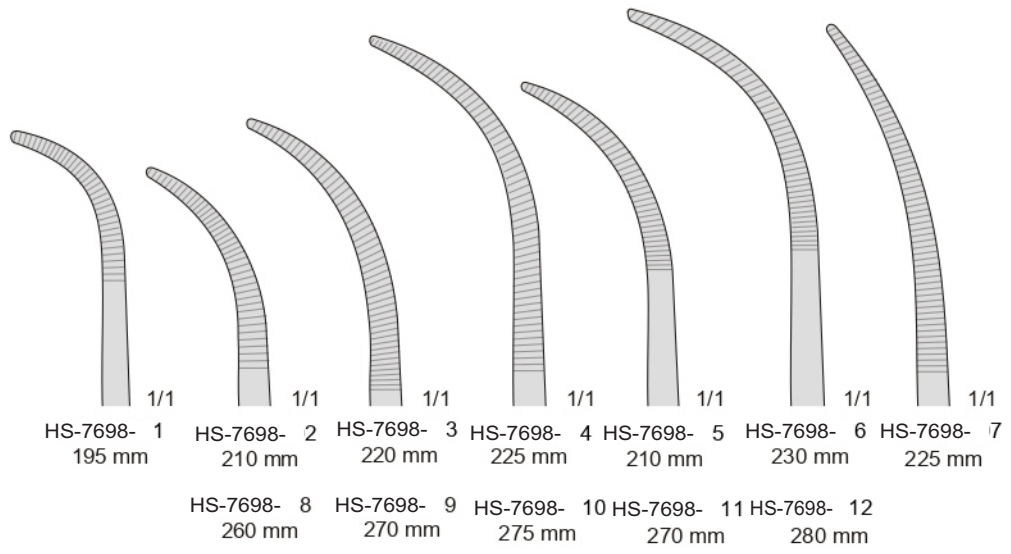

OVERHOLT  
HS-7699

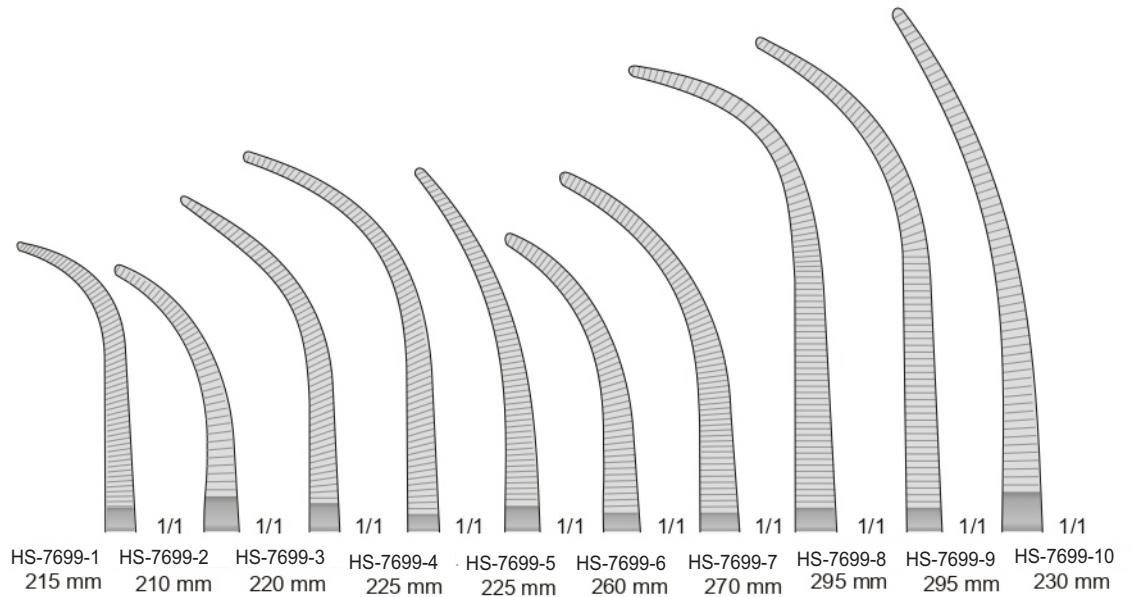

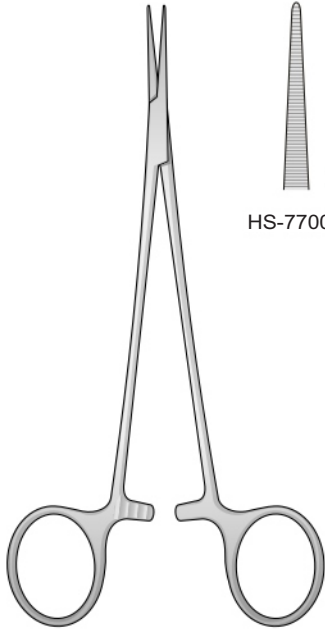

HS-7700  
 160 mm

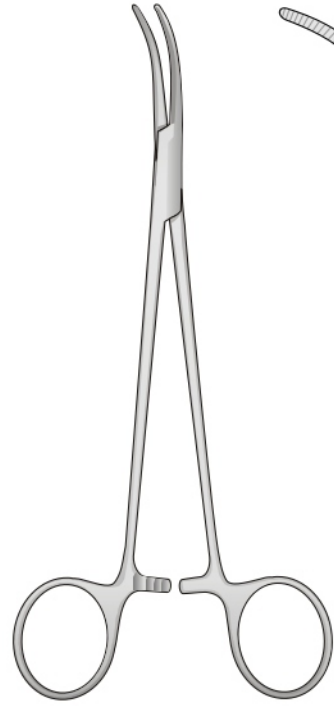
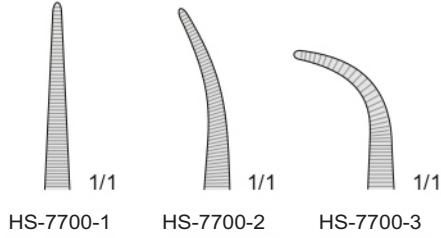

ROCHESTER-PEAN  
 HS-7701  
 180 mm

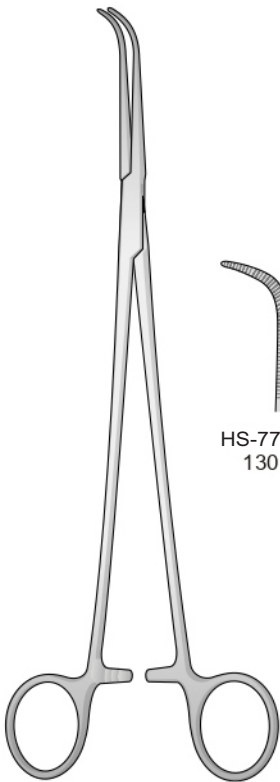
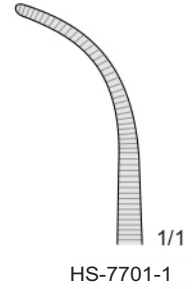

GEMINI  
 HS-7702

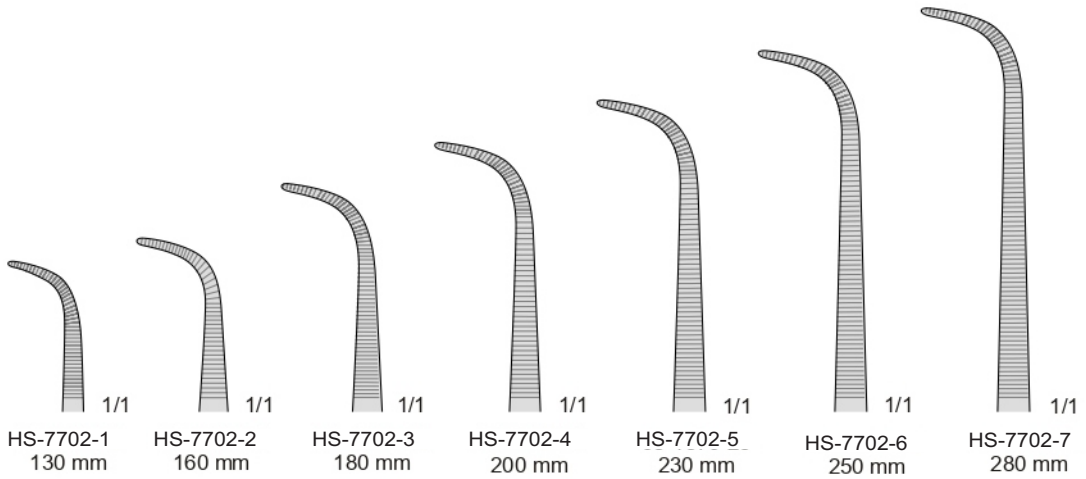



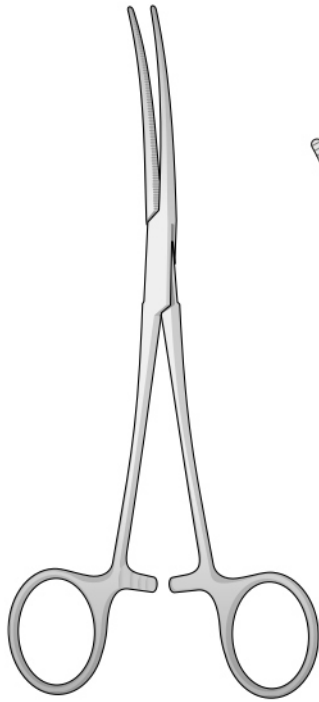

CRAFOORD  
HS-7703

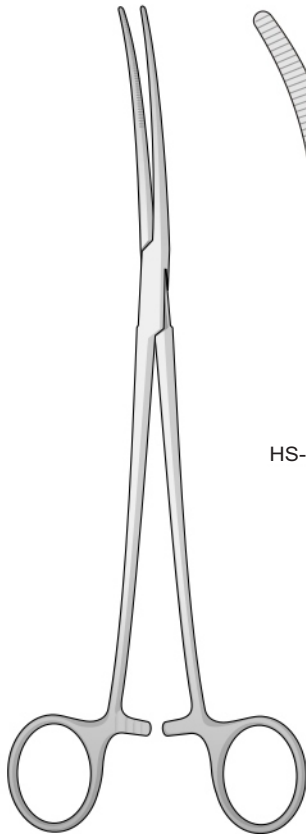
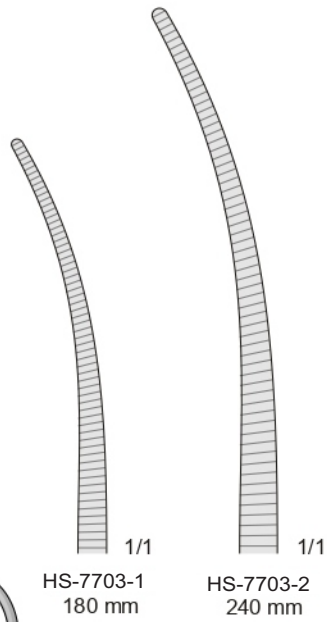

RUMEL  
HS-7704  
240 mm

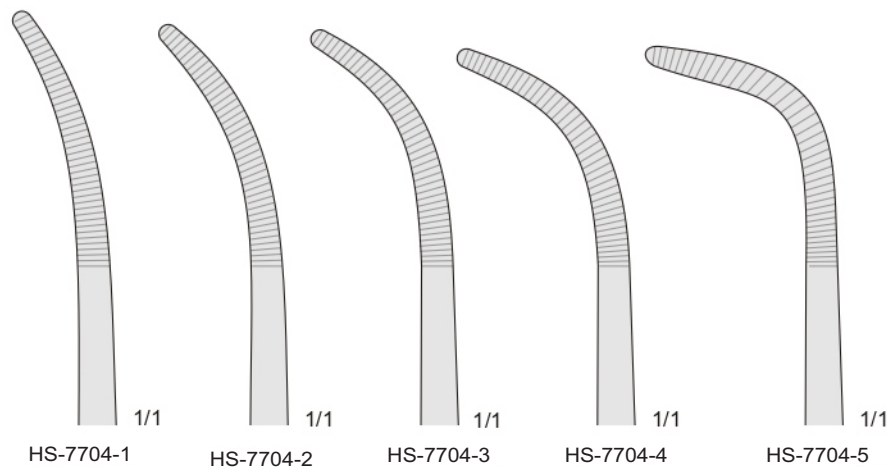

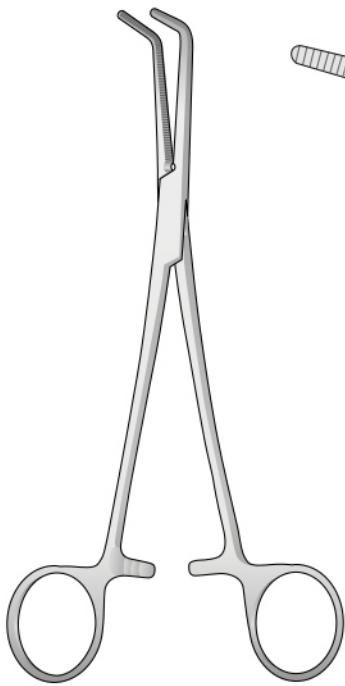

MIXTER  
 HS-7705

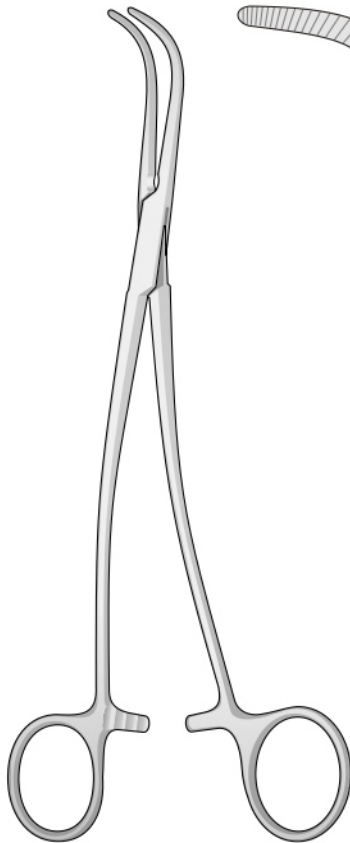
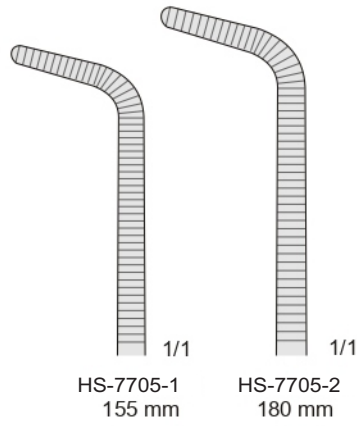

GRAY  
 HS-7706  
 220 mm

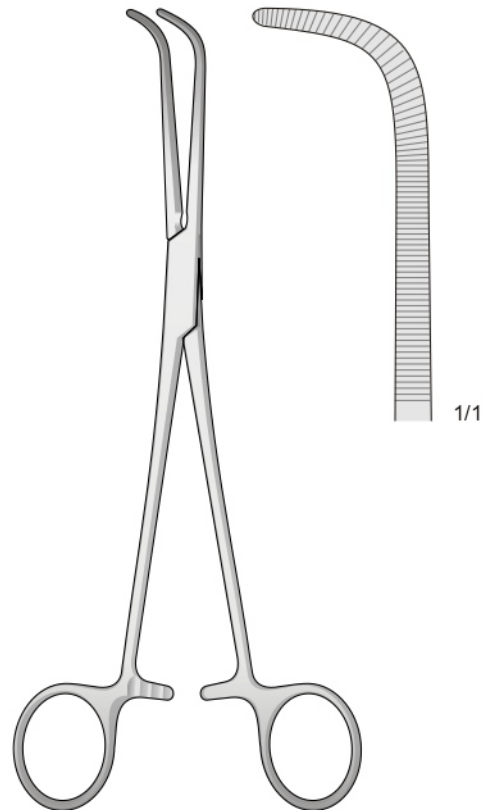
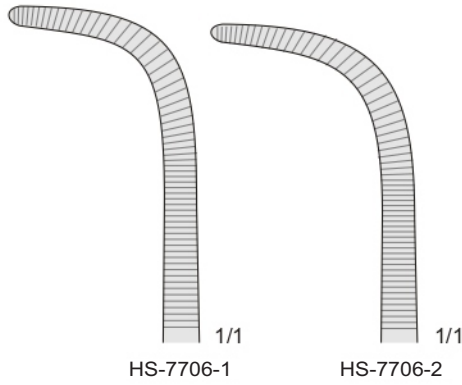

WIKSTROEM  
 HS-7707  
 205 mm



Pinze per tonsille  
Tonsil forceps  
Tonsillenklemmen  
Pincés pour amygdales  
Pinzas para amígdalas

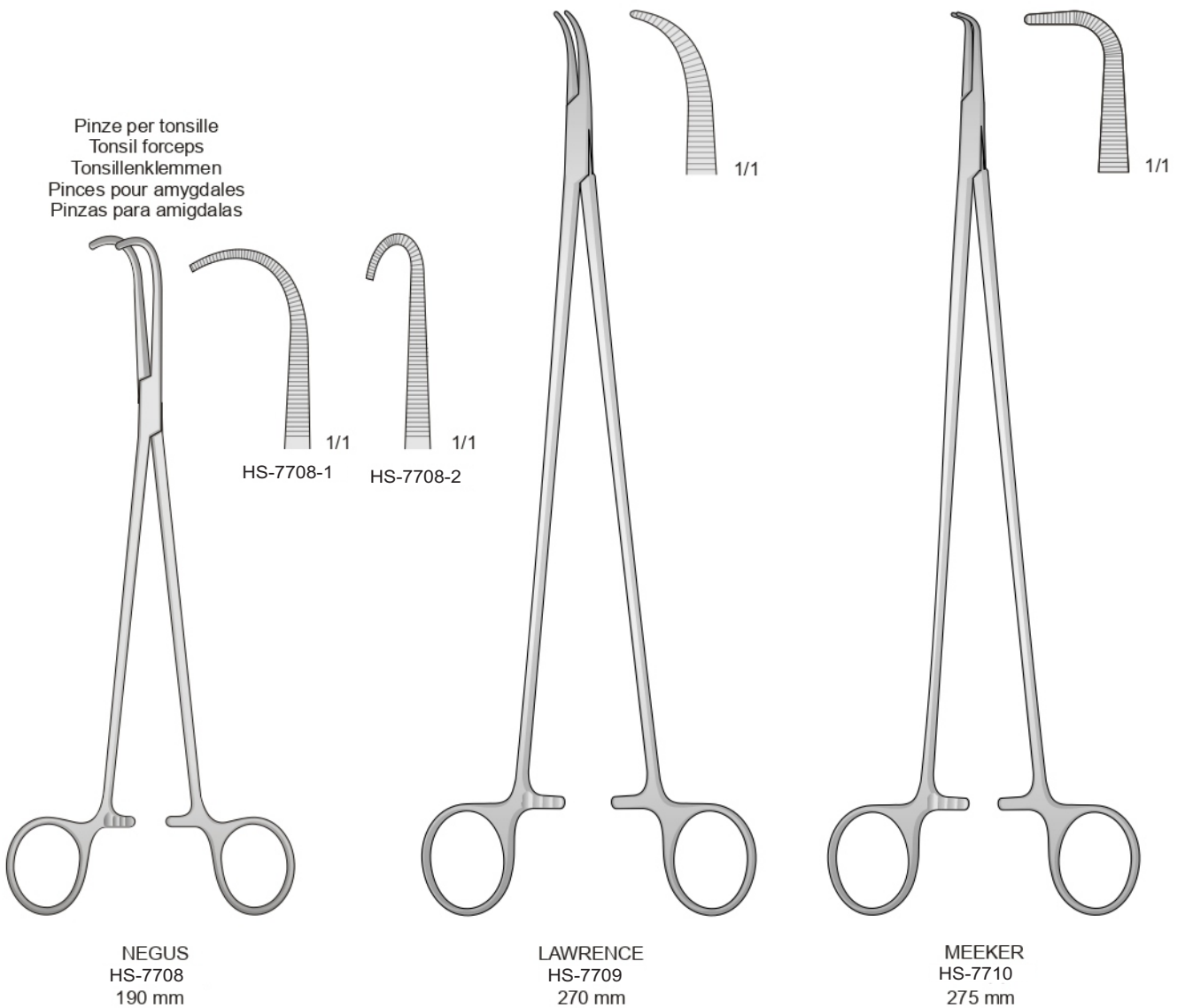



**Hemostatic Forceps**

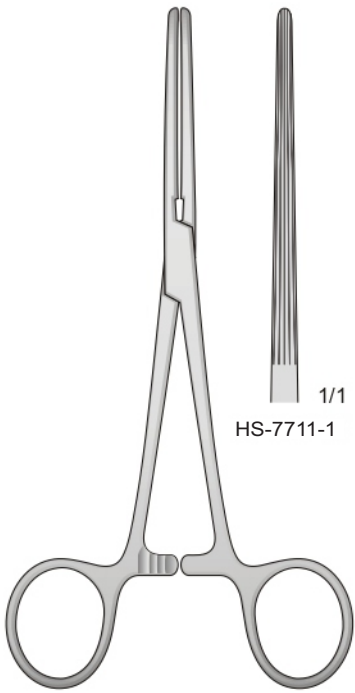

BAINBRIDGE  
HS-7711  
150 mm

HS-7711-1  
1/1



HS-7711-2  
1/1

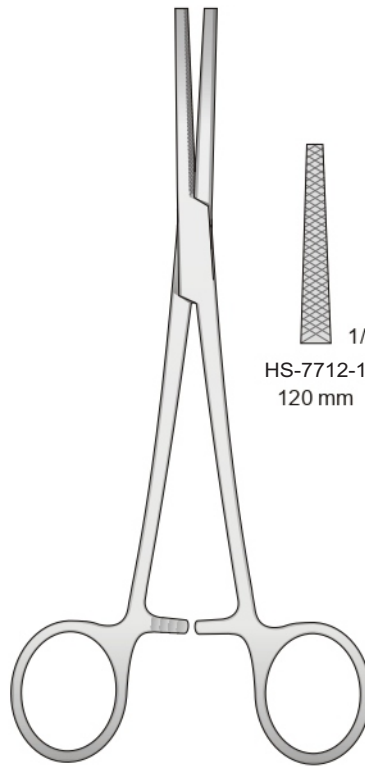

HS-7712

HS-7712-1  
120 mm  
1/1



HS-7712-2  
180 mm  
1/1



HS-7712-3  
200 mm  
1/1



Angiotribe - Druckklemmen  
Angiotribes - Pinzas-clamps para presión progresiva

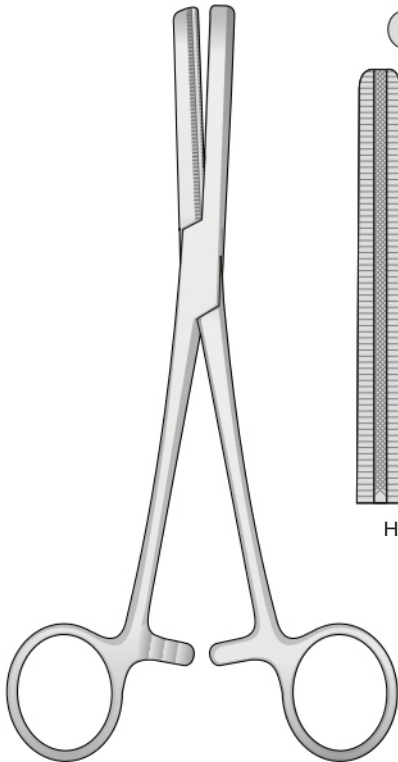

FERGUSSON  
HS-7713

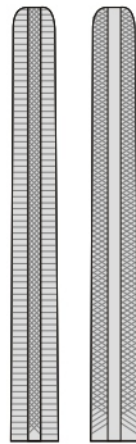

HS-7713-1  
200 mm  
1/1

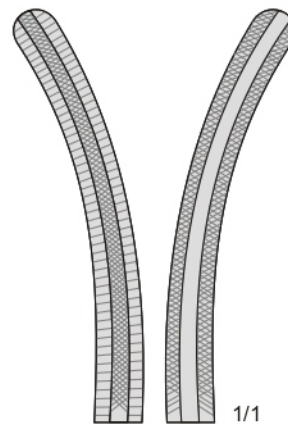

HS-7713-2  
200 mm  
1/1

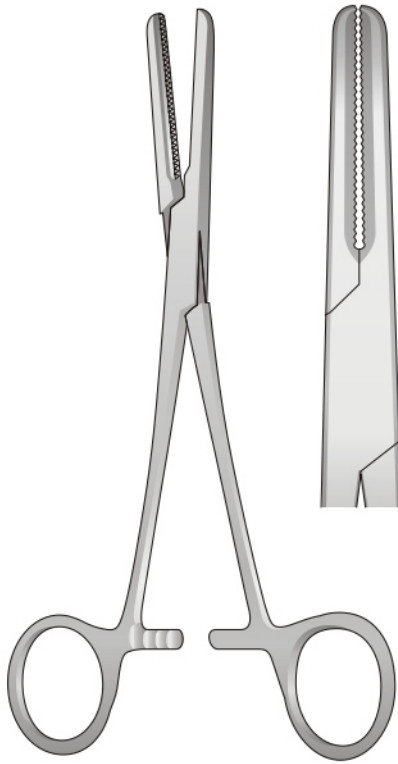

HS-7714

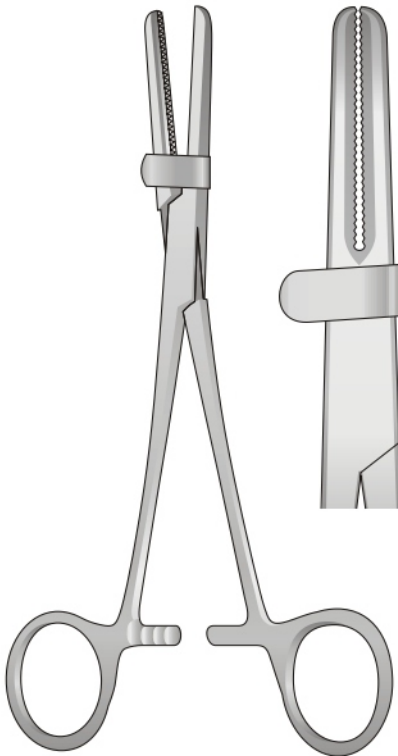
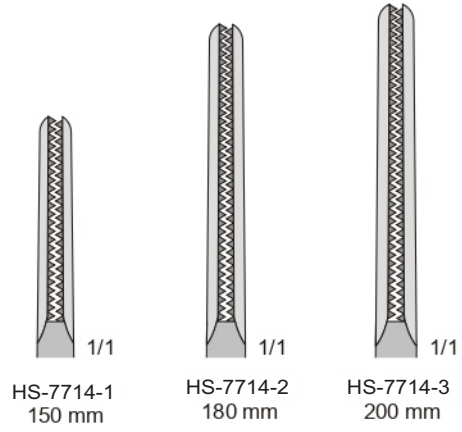

HS-7714

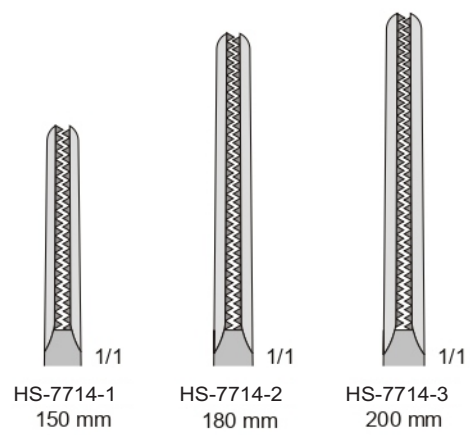

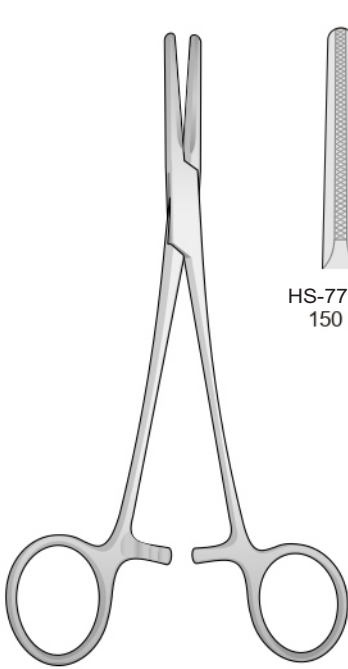

05-1540

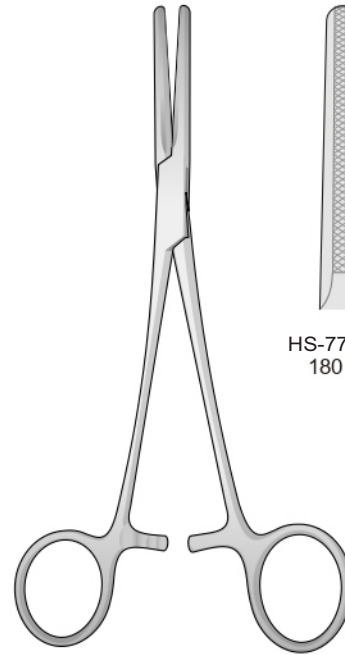
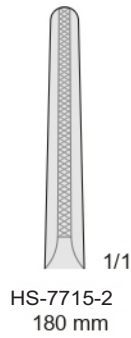
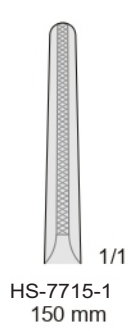

HS-7716  
 180 mm

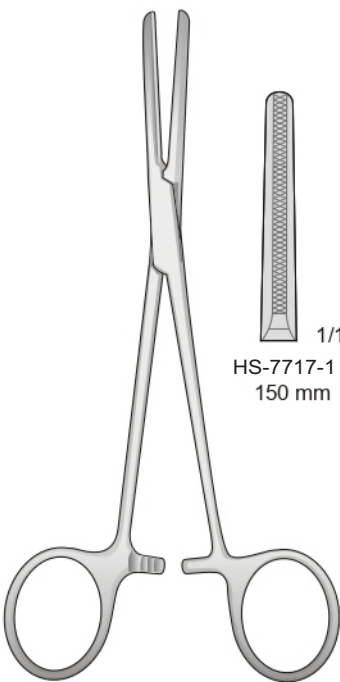
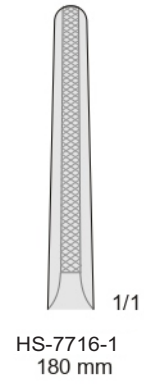

HS-7717

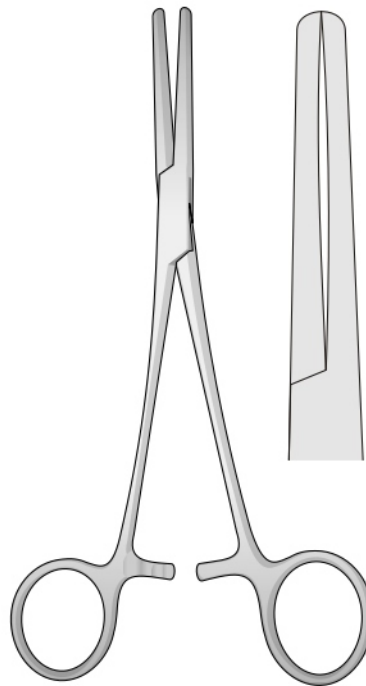
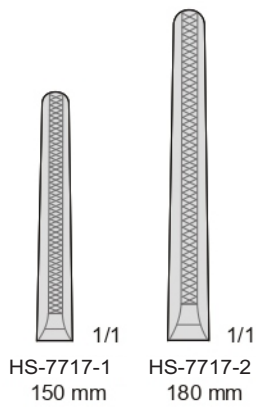

HS-7718

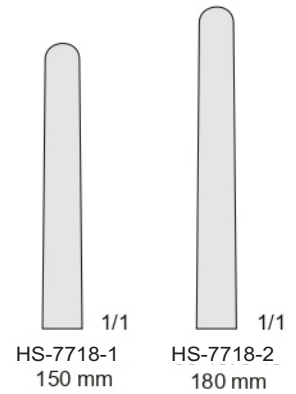



**Manufacturer & Exporter  
Of Surgical, Dental & Beauty Instruments.**



# Health Fast Surgical

Surgical Manufacturer Company

+92 (342) 880 9017

+92 (342) 880 9017

info@healthfastsurgical.com

www.healthfastsurgical.com

Dogra Khurd, P.O Harrar Sialkot-51310 Pakistan.



ISO  
9001:2008

