

SURGICAL INSTRUMENTS CATALOGUE

Gynecology
Urology

www.healthfastsurgical.com



Health Fast Surgical
Surgical Manufacturer Company

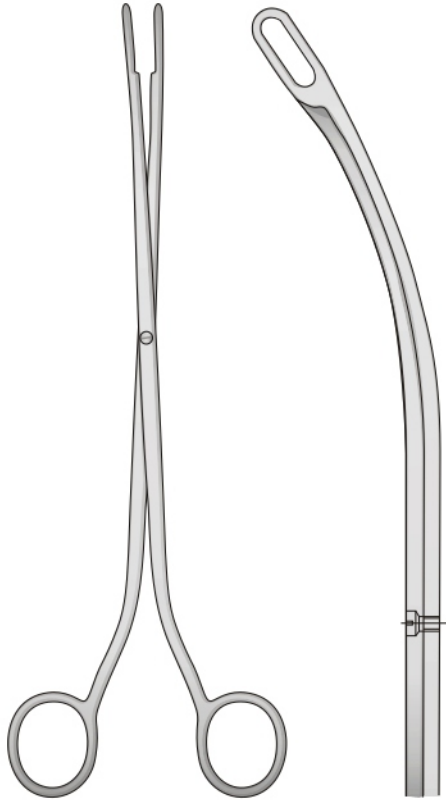

DESJARDINS

HS-7001
225 mm

Fig. 1



HS-7001-1

Fig. 3



HS-7001-2

Fig. 2



HS-7001-3

Fig. 4



HS-7001-4

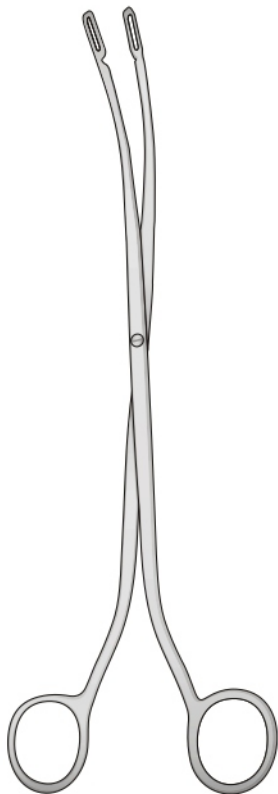

RANDALL

HS-7002
225 mm

Fig. 1



HS-7002-1

Fig. 3



HS-7002-2

Fig. 2



HS-7002-3

Fig. 4



HS-7002-4



Per uomini
For men
Für Männer
Pour hommes
Para hombres

Charr.	
HS-7003-1	8
HS-7003-2	10
HS-7003-3	12
HS-7003-4	14
HS-7003-5	16
HS-7003-6	18
HS-7003-7	20

Ø 2,7 mm

Ø 3 mm

Per donne
For woman
Für Frauen
Pour femmes
Para mujeres

Charr.	
HS-7004-1	6
HS-7004-2	8
HS-7004-3	10
HS-7004-4	12
HS-7004-5	14
HS-7004-6	16
HS-7004-7	18

Ø 1,2 mm

Ø 3 mm

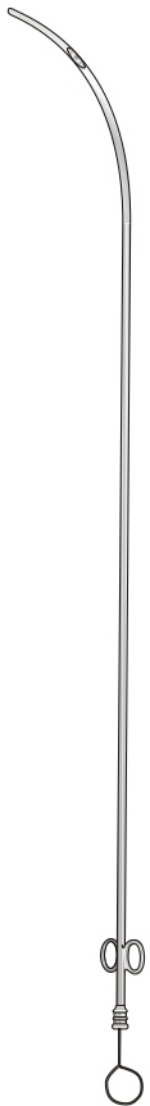

HS-7003
290 mm



HS-7004
160 mm

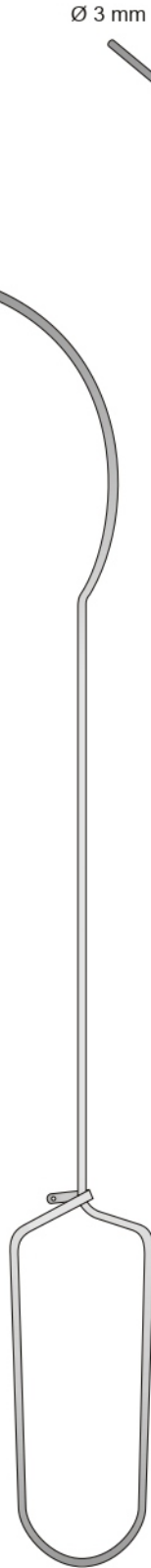

GUYON
HS-7005
365 mm

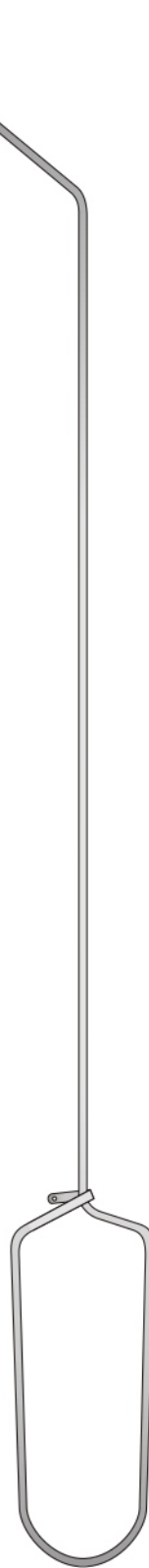

BENIQUE
HS-7006
410 mm

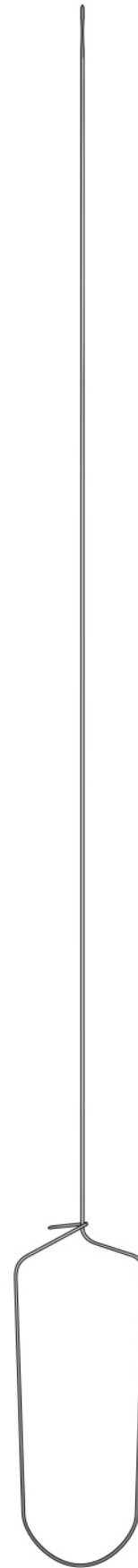

HS-7007
460 mm

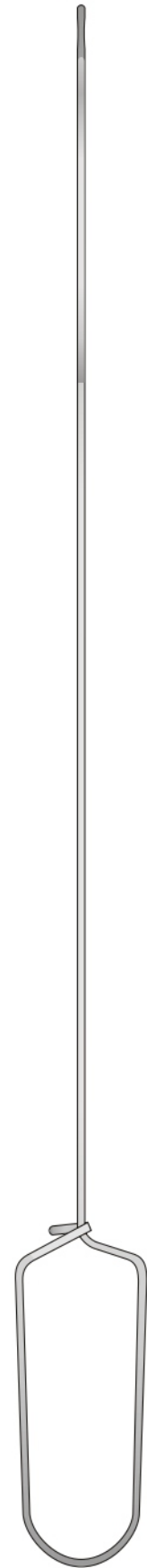

HS-7008
460 mm



- HS-7009-1 - 190 mm - Ø 3 mm
- HS-7009-2 - 190 mm - Ø 4 mm
- HS-7009-3 - 190 mm - Ø 5 mm
- HS-7009-4 - 190 mm - Ø 6 mm
- HS-7009-5 - 190 mm - Ø 7 mm
- HS-7009-6 - 190 mm - Ø 8 mm
- HS-7009-7 - 190 mm - Ø 9 mm
- HS-7009-8 - 190 mm - Ø 10 mm
- HS-7009-9 - 190 mm - Ø 11 mm

- HS-7010-1 - 300 mm - Ø 1 mm
- HS-7010-2 - 300 mm - Ø 2 mm
- HS-7010-3 - 300 mm - Ø 3 mm
- HS-7010-4 - 300 mm - Ø 4 mm
- HS-7010-5 - 300 mm - Ø 5 mm
- HS-7010-6 - 300 mm - Ø 6 mm
- HS-7010-7 - 300 mm - Ø 7 mm
- HS-7010-8 - 300 mm - Ø 8 mm
- HS-7010-9 - 300 mm - Ø 9 mm
- HS-7010-10 - 300 mm - Ø 10 mm
- HS-7010-11 - 300 mm - Ø 11 mm
- HS-7010-12 - 300 mm - Ø 12 mm
- HS-7010-13 - 300 mm - Ø 13 mm

HS-7009
Set completo di 9 pezzi
con custodia

HS-7010
Set completo di
13 pezzi

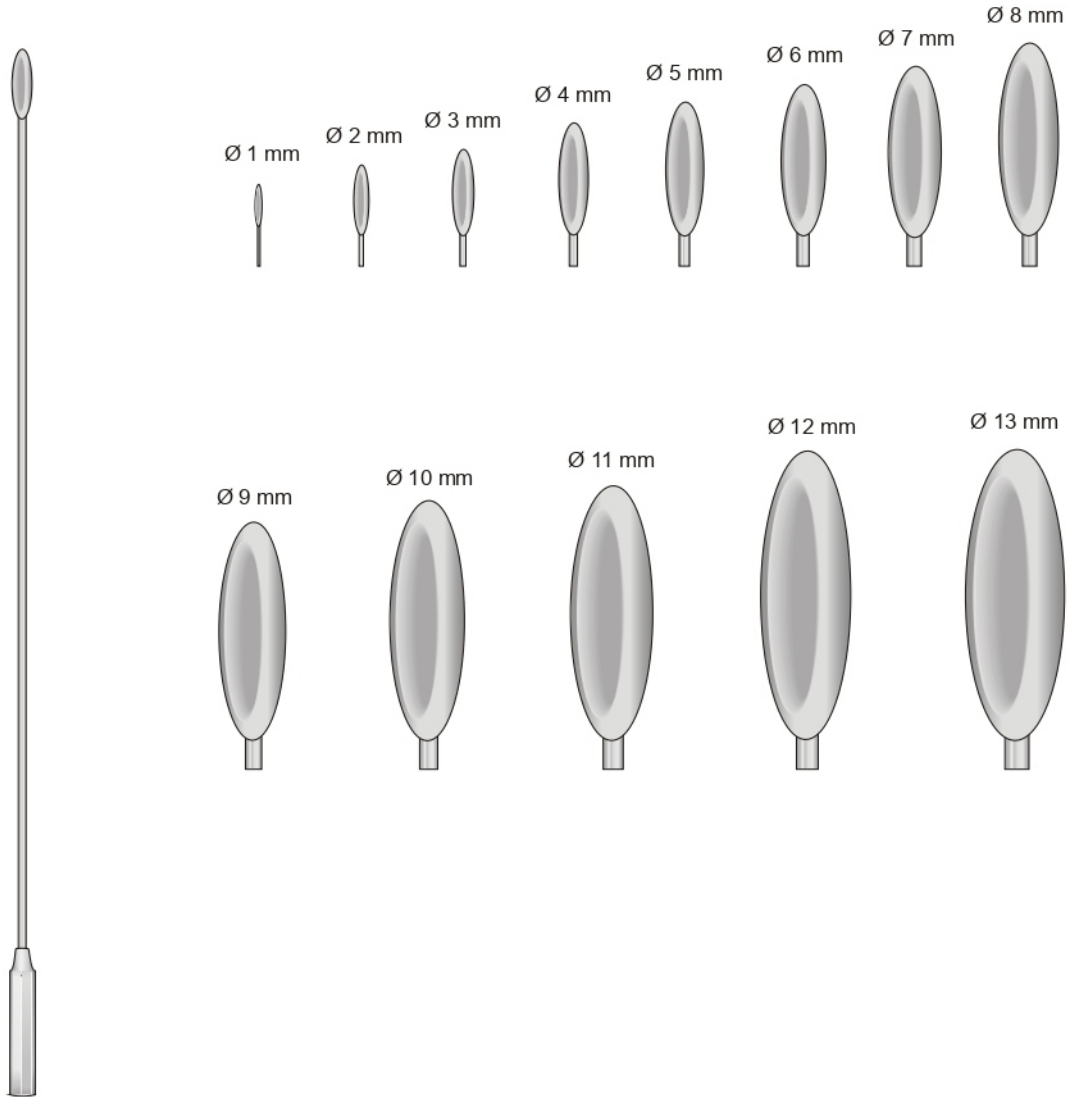

BAKES
HS-7009



DITTEL
HS-7011
220 mm

Charr.

HS-7011-1	8
HS-7011-2	9
HS-7011-3	10
HS-7011-4	11
HS-7011-5	12
HS-7011-6	14
HS-7011-7	16
HS-7011-8	18
HS-7011-9	20
HS-7011-10	22
HS-7011-11	24
HS-7011-12	25
HS-7011-13	26
HS-7011-14	27
HS-7011-15	28
HS-7011-16	29
HS-7011-17	30

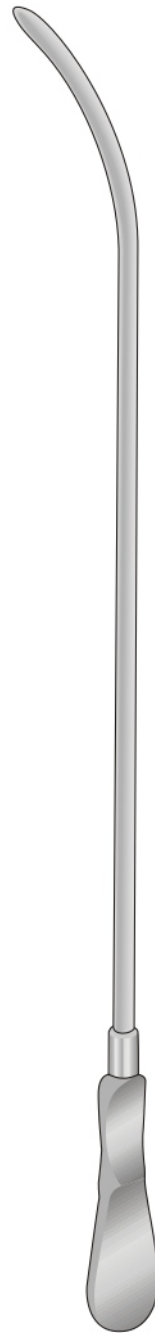

DITTEL
HS-7012
345 mm

Charr.

HS-7012-1	8
HS-7012-2	9
HS-7012-3	10
HS-7012-4	11
HS-7012-5	12
HS-7012-6	13
HS-7012-7	14
HS-7012-8	15
HS-7012-9	16
HS-7012-10	17
HS-7012-11	18
HS-7012-12	19
HS-7012-13	20
HS-7012-14	21
HS-7012-15	22
HS-7012-16	23
HS-7012-17	24
HS-7012-18	25
HS-7012-19	26
HS-7012-20	27
HS-7012-21	28
HS-7012-22	29
HS-7012-23	30



HS-7013-1 - Ø 10 mm  1/1

HS-7013-2 - Ø 9 mm  1/1

HS-7013-3 - Ø 8 mm  1/1

HS-7013-4 - Ø 7 mm  1/1

HS-7013-5 - Ø 6 mm  1/1

HS-7013-6 - Ø 5 mm  1/1

HS-7013-7 - Ø 4 mm  1/1

HS-7013-8 - Ø 3 mm  1/1

HS-7013
190 mm



Sonde per dotto biliare, Elastiche
Gall Stone Probes, Elastic
Gallensteinsonden, Federnd
Explorateurs pour calculs biliaires, Élastiques
Exploradores para cálculos biliaires, Elásticos

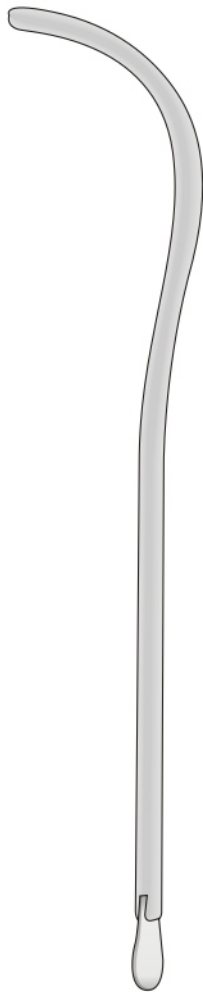

GUYON
HS-7014
255 mm

	Ben.	Charr.
HS-7014-1	24	12
HS-7014-2	26	13
HS-7014-3	28	14
HS-7014-4	30	15
HS-7014-5	32	16
HS-7014-6	34	17
HS-7014-7	36	18
HS-7014-8	38	19
HS-7014-9	40	20
HS-7014-10	42	21
HS-7014-11	44	22
HS-7014-12	46	23
HS-7014-13	48	24
HS-7014-14	50	25
HS-7014-15	52	26
HS-7014-16	54	27
HS-7014-17	56	28
HS-7014-18	58	29
HS-7014-19	60	30



DESJARDINS
HS-7015
280 mm

Ø 4,3 mm



1/1

HS-7015-1

Ø 6,0 mm



1/1

HS-7015-2

Ø 7,0 mm



1/1

HS-7015-3

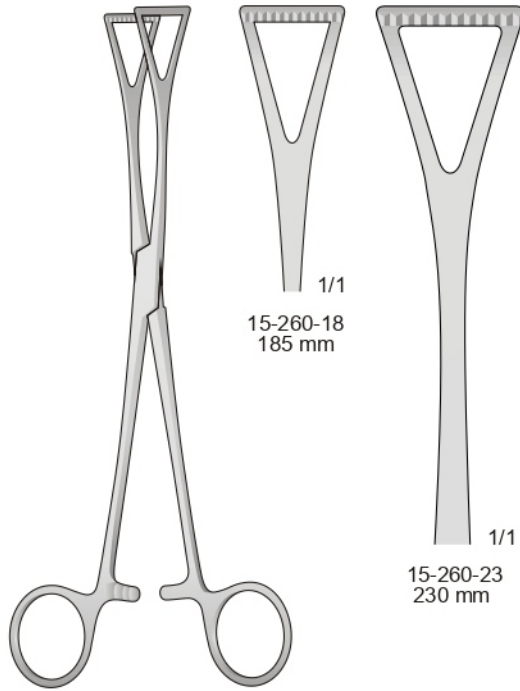

DUVAL
HS-7016

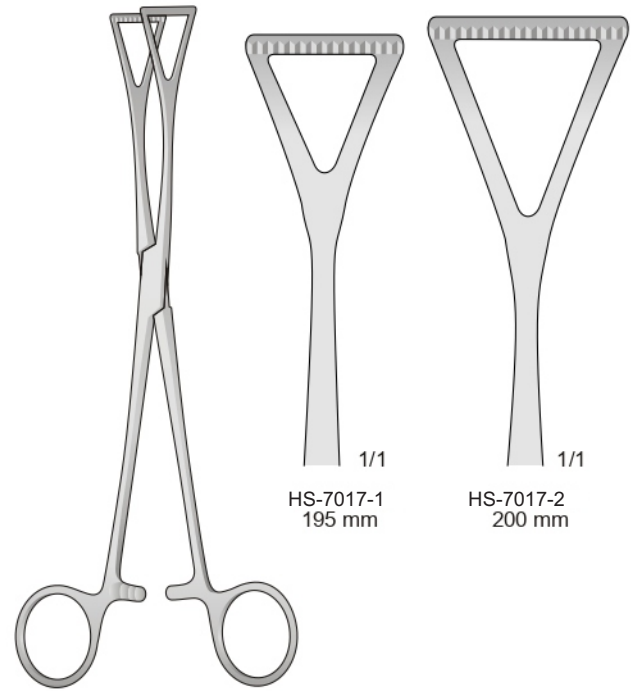

DUVAL-COLLIN
HS-7017

Pinze per peduncoli renali - Kidney pedicle clamp forceps - Nierenstielklemmen
Pincas-clamps pour pédicules rénaux - Pinzas-clamps para pedúnculos renales

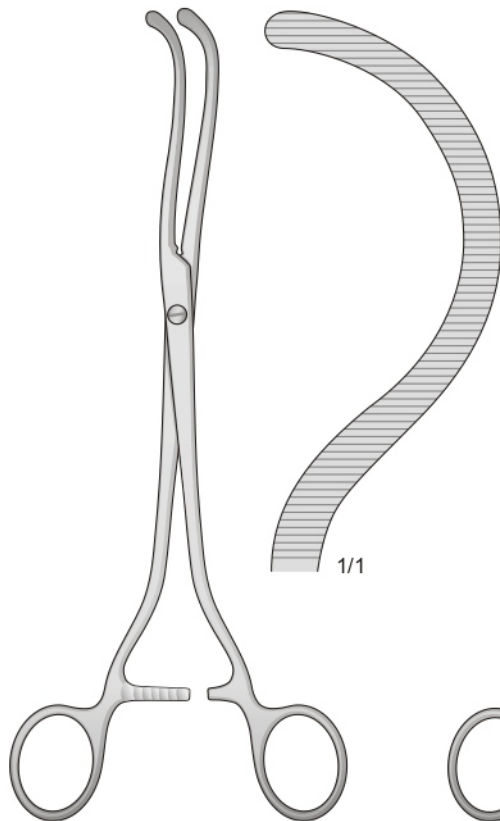

BRAUN
HS-7018
245 mm

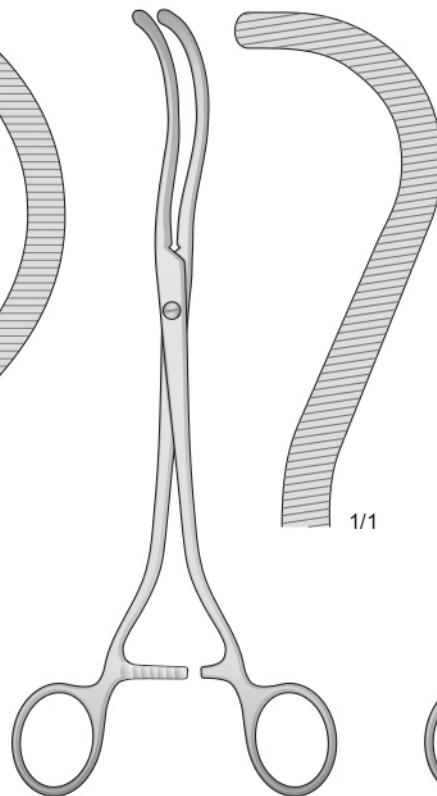

GUYON
15-290-23
235 mm

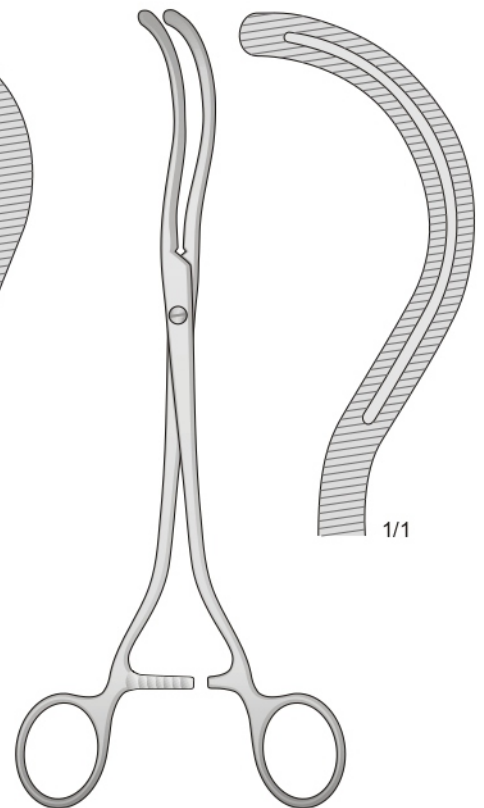

STILLE
HS-7020
240 mm

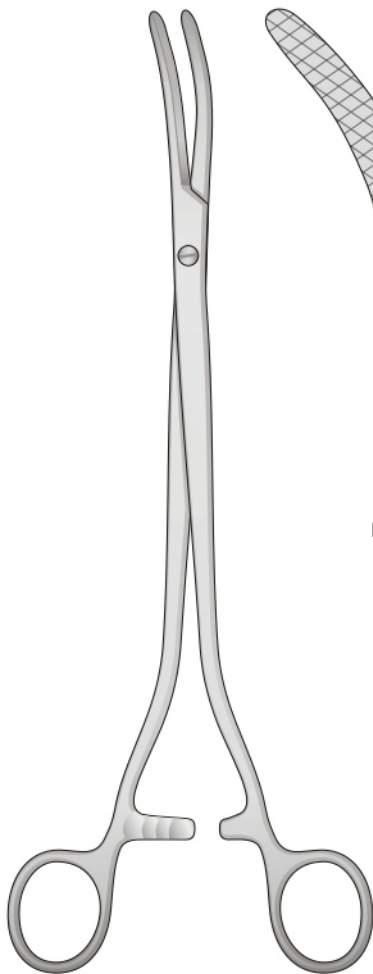

1/1
HS-7021-1

WERTHEIM
HS-7021
260 mm

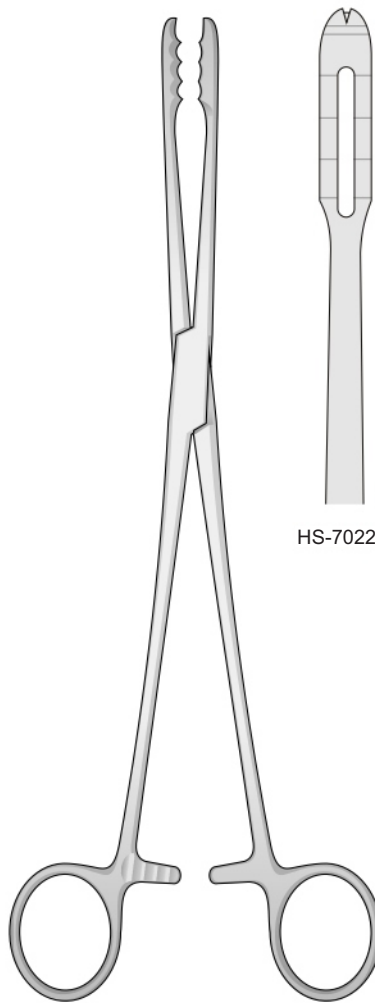

1/1
HS-7022-1

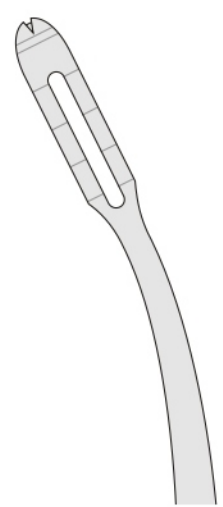

1/1
HS-7022-2

HS-7022
265 mm

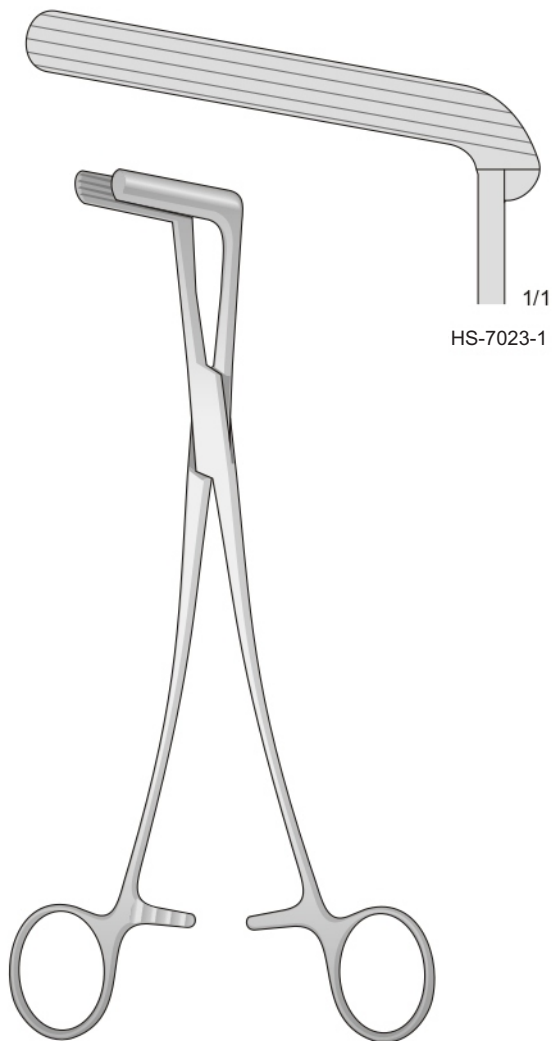

WERTHEIM
HS-7023
235 mm

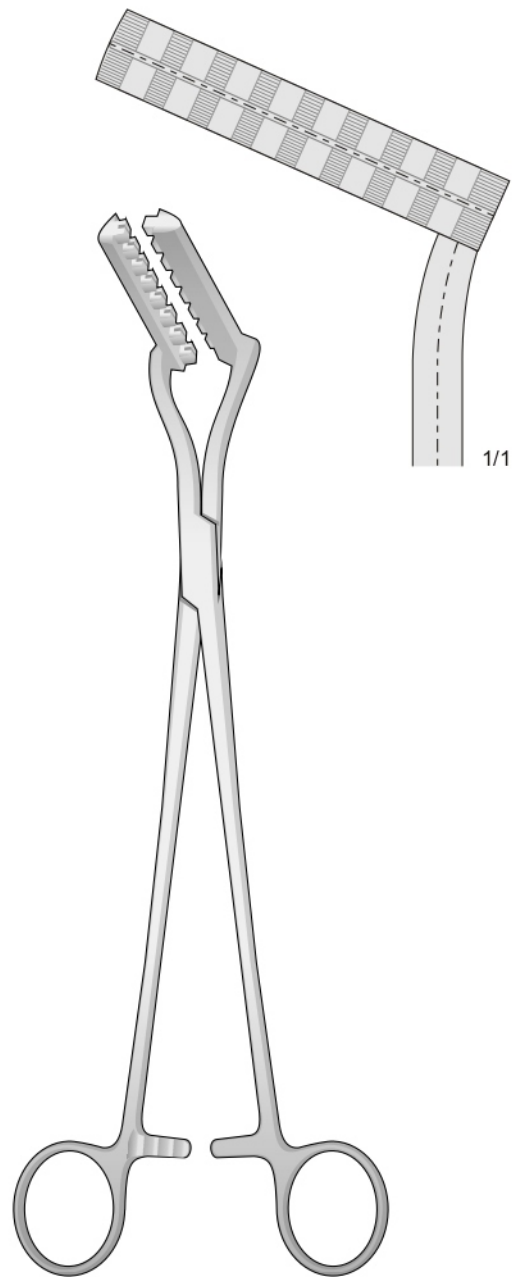

HS-7024
280 mm

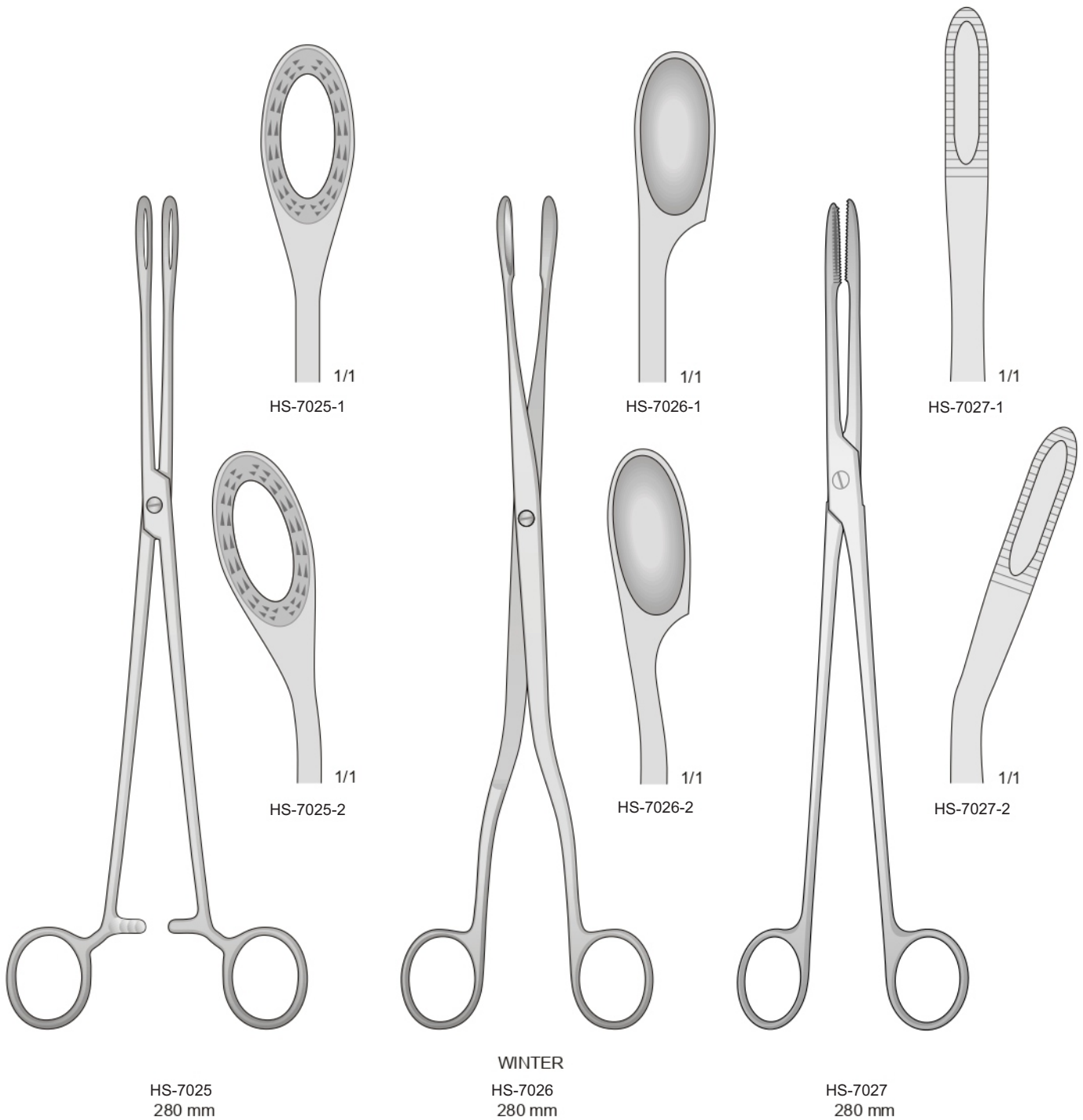



Artery Forceps

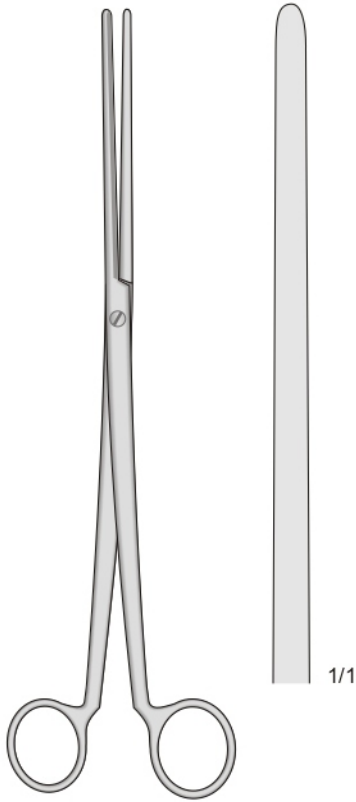

COLLIN
HS-7028
260 mm

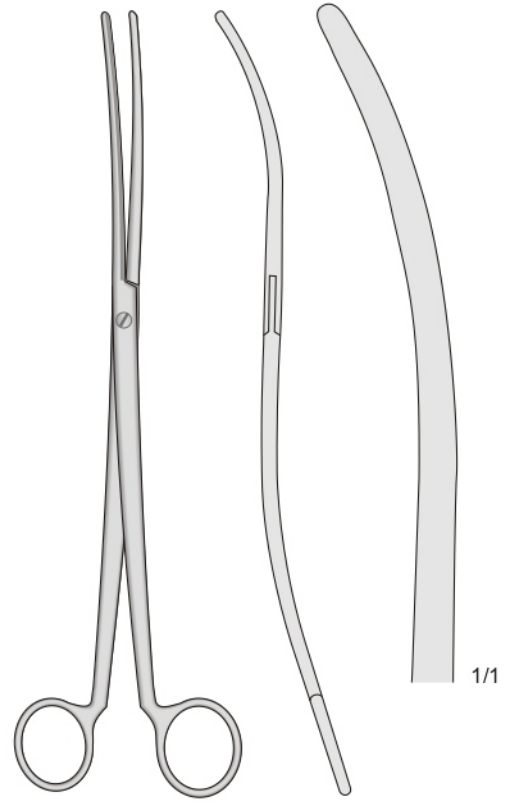

COLLIN
HS-7029
260 mm

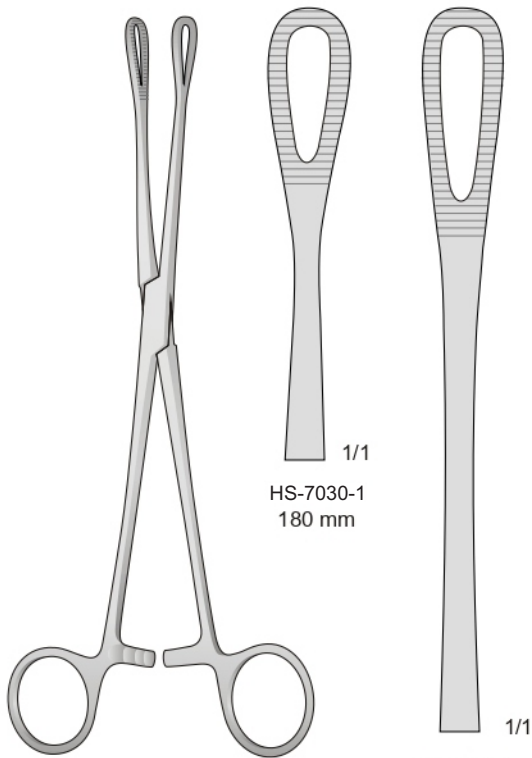

RAMPLEY
HS-7030

HS-7030-1
180 mm

HS-7030-2
245 mm

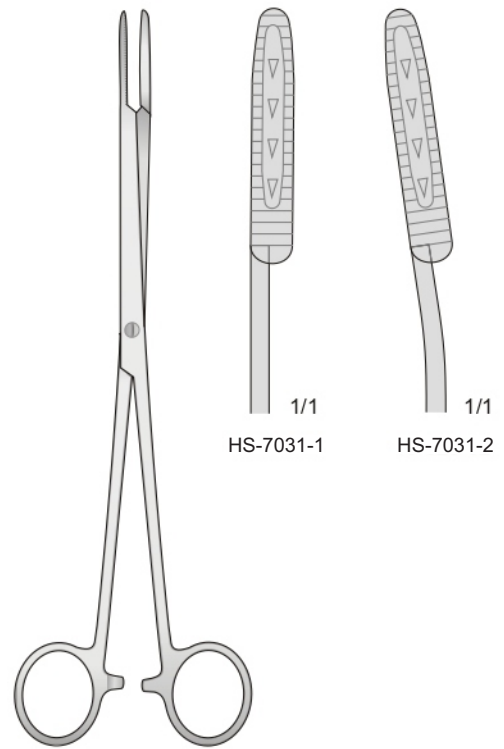

MAIER
HS-7031
245 mm

HS-7031-1

HS-7031-2



HS-7032
 Set 2 pezzi - Set 2 pieces
 Set 2 stück - Set 2 pièces
 Set 2 piezos
 70 x 40 mm
 70 x 33 mm

HS-7032-2 - 70 x 33 mm
 170 mm

KALLMORGEN
 HS-7032-1 - 70 x 40 mm
 170 mm

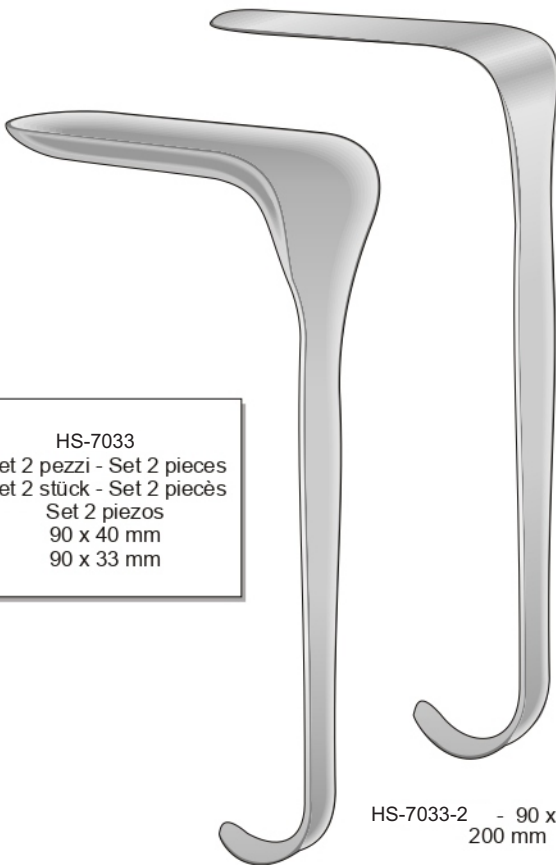

HS-7033
 Set 2 pezzi - Set 2 pieces
 Set 2 stück - Set 2 pièces
 Set 2 piezos
 90 x 40 mm
 90 x 33 mm

HS-7033-2 - 90 x 33 mm
 200 mm

KALLMORGEN
 HS-7033-1 - 90 x 40 mm
 200 mm

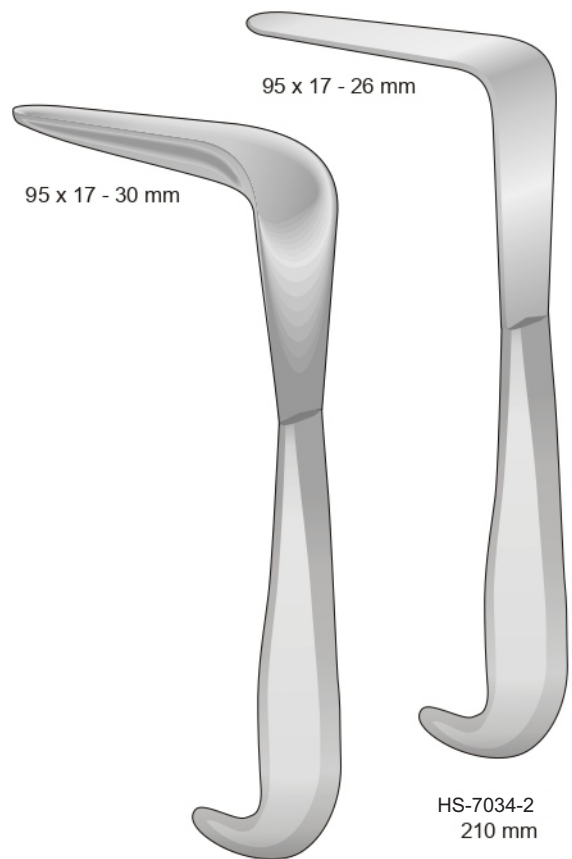

95 x 17 - 26 mm

95 x 17 - 30 mm

HS-7034-2
 210 mm

MATHIEU
 HS-7034-1
 210 mm

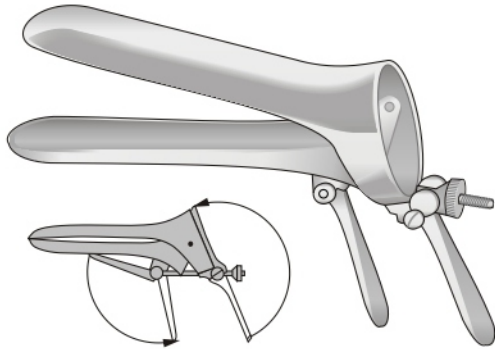

CUSCO
 HS-7035-1 Fig. 0 77x17 mm
 HS-7035-2 Fig. 1 75x33 mm
 HS-7035-3 Fig. 2 86x36 mm
 HS-7035-4 Fig. 3 97x36 mm

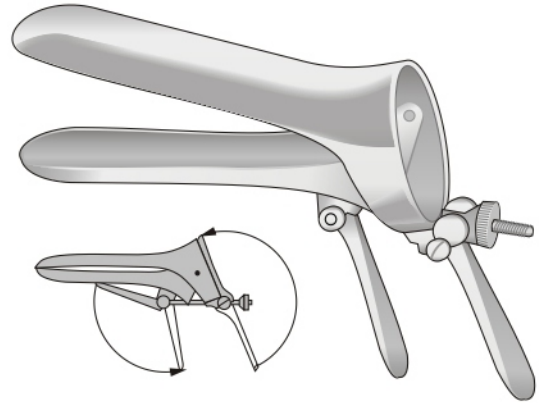

**CUSCO
SCHWEIZER MODELL**
 HS-7036-1 Fig.1 90x23 mm
 HS-7036-2 Fig.2 100x24 mm
 HS-7036-3 Fig.3 105x27 mm

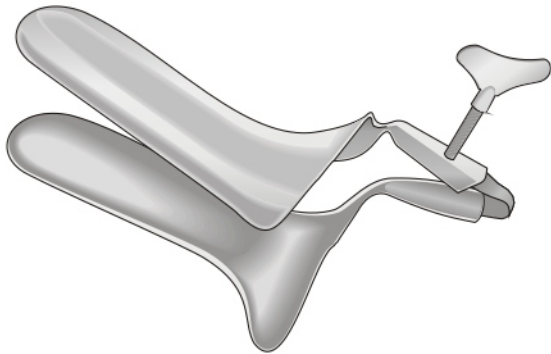

COLLIN-STANDARD
 HS-7037-1 Fig. 1 90x29 mm
 HS-7037-2 Fig. 2 95x35 mm
 HS-7037-3 Fig. 3 110x40 mm

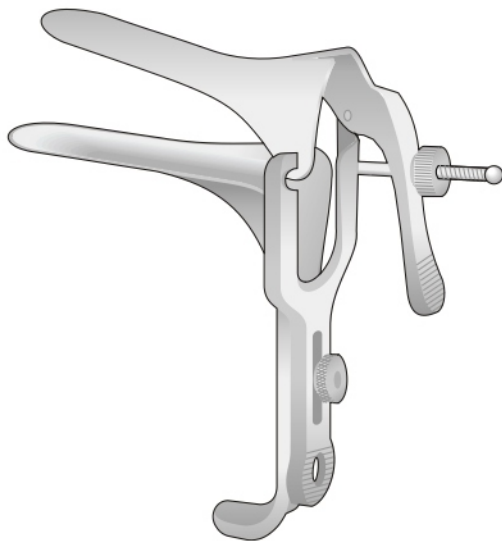

GRAVE
 HS-7038-1 75x20 mm
 HS-7038-2 95x30 mm
 HS-7038-3 105x33 mm

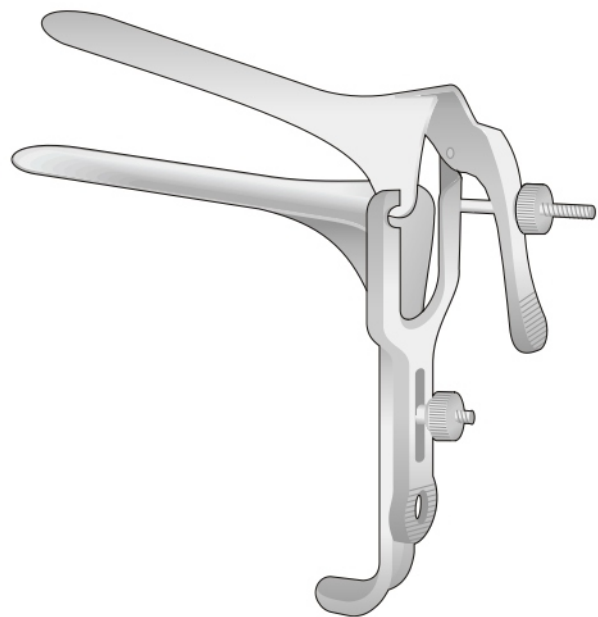

PEDERSON
 HS-7039-1 700x22 mm
 HS-7039-2 720x25 mm

Speculum
Spekula
Specula
Spéculums
Espéculos



KRISTELLER

- Fig. 1 HS-7040-1 - 70 x 27 mm
- Fig. 2 HS-7040-2 - 75 x 30 mm
- Fig. 3 HS-7040-3 - 90 x 36 mm

Valva
Halter
Retractors
Valves
Valvas



KRISTELLER

- Fig. 1 HS-7040-4 - 75 x 23 mm
- Fig. 2 HS-7040-5 - 80 x 26 mm
- Fig. 3 HS-7040-6 - 95 x 32 mm

Speculum + Valva
Specula + Retractor
Spekula + Halter
Spéculum + Valve
Espéculo + Valva



- Fig. 1 HS-7041-1
- Fig. 2 HS-7041-2
- Fig. 3 HS-7041-3

Speculum
Spekula
Specula
Spéculums
Espéculos



KRISTELLER

- Fig. 00 HS-7043-1 - 110 x 18 mm
- Fig. 0 HS-7043-2 - 110 x 21 mm
- Fig. 1 HS-7043-3 - 110 x 27 mm
- Fig. 2 HS-7043-4 - 110 x 30 mm
- Fig. 3 HS-7043-5 - 110 x 36 mm

Valva
Halter
Retractors
Valves
Valvas



KRISTELLER

- Fig. 00 HS-7043-6 - 115 x 14 mm
- Fig. 0 HS-7043-7 - 115 x 17 mm
- Fig. 1 HS-7043-8 - 115 x 23 mm
- Fig. 2 HS-7043-9 - 115 x 26 mm
- Fig. 3 HS-7043-10 - 115 x 32 mm

Speculum + Valva
Specula + Retractor
Spekula + Halter
Spéculum + Valve
Espéculo + Valva



- Fig. 00 HS-7044-1
- Fig. 0 HS-7044-2
- Fig. 1 HS-7044-3
- Fig. 2 HS-7044-4
- Fig. 3 HS-7044-5

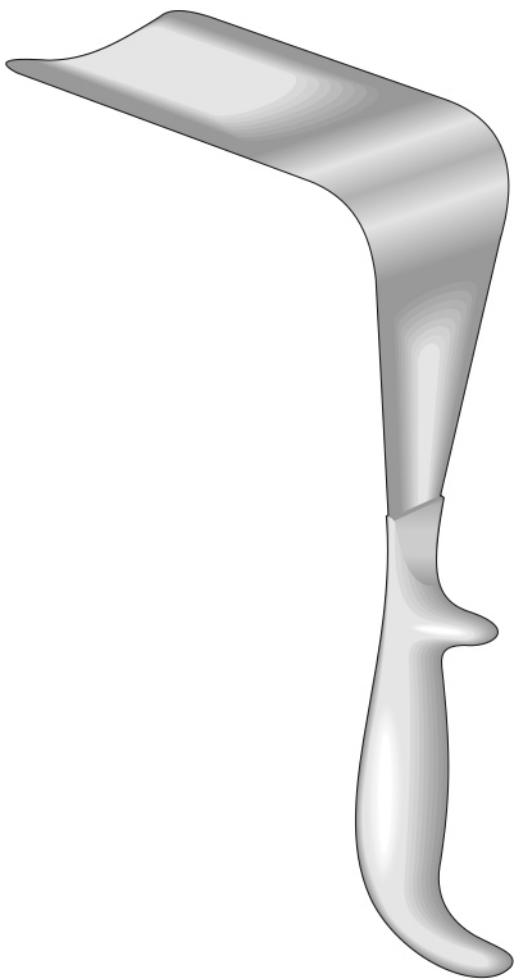

DOYEN
 HS-7045
 240 mm

- Fig. 1 HS-7045-1 - 60 x 35 mm
- Fig. 2 HS-7045-2 - 90 x 35 mm
- Fig. 3 HS-7045-3 - 120 x 35 mm

- Fig. 1 HS-7045-4 - 60 x 45 mm
- Fig. 2 HS-7045-5 - 90 x 45 mm
- Fig. 3 HS-7045-6 - 120 x 45 mm
- Fig. 4 HS-7045-7 - 160 x 45 mm

- Fig. 1 HS-7045-8 - 60 x 60 mm
- Fig. 2 HS-7045-9 - 90 x 60 mm
- Fig. 3 HS-7045-10 - 120 x 60 mm
- Fig. 4 HS-7045-11 - 160 x 60 mm



LANDAU
 HS-7046
 290 mm

- HS-7046-1 - 100 x 28 mm
- HS-7046-2 - 100 x 38 mm



BREISKY
 HS-7047-1 - 100 x 20 mm
 HS-7047-2 - 100 x 25 mm
 HS-7047-3 - 100 x 30 mm
 HS-7047-4 - 100 x 35 mm
 HS-7047-5 - 100 x 40 mm
 290 mm

BREISKY
 HS-7048-1 - 130 x 20 mm
 HS-7048-2 - 130 x 25 mm
 HS-7048-3 - 130 x 30 mm
 HS-7048-4 - 130 x 35 mm
 HS-7048-5 - 130 x 40 mm
 320 mm

BREISKY
 HS-7049 - 160 x 40 mm
 350 mm

BREISKY
 HS-7050 - 180 x 40 mm
 370 mm



Hegar Dilatatori - Hegar Dilatators - Hegar Dilatatore - Hegar Dilateur - Hegar Dilatadores

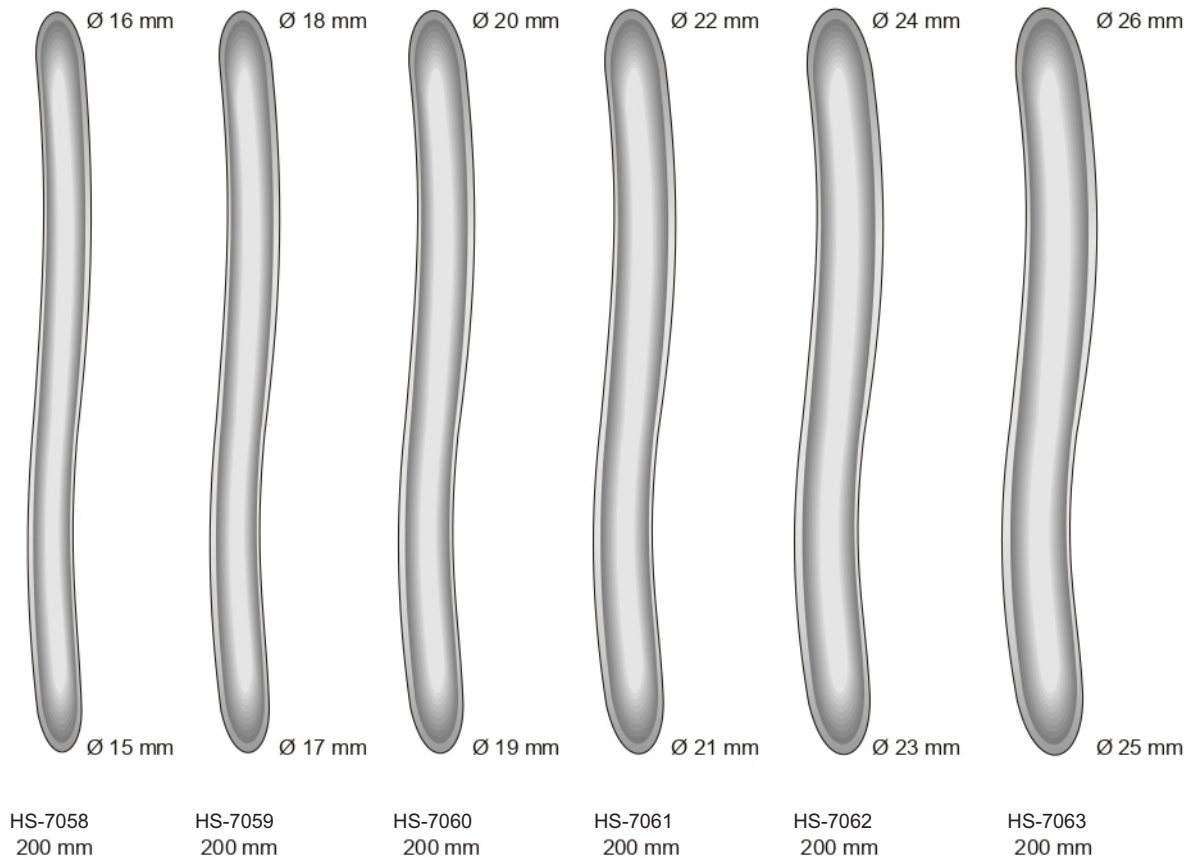
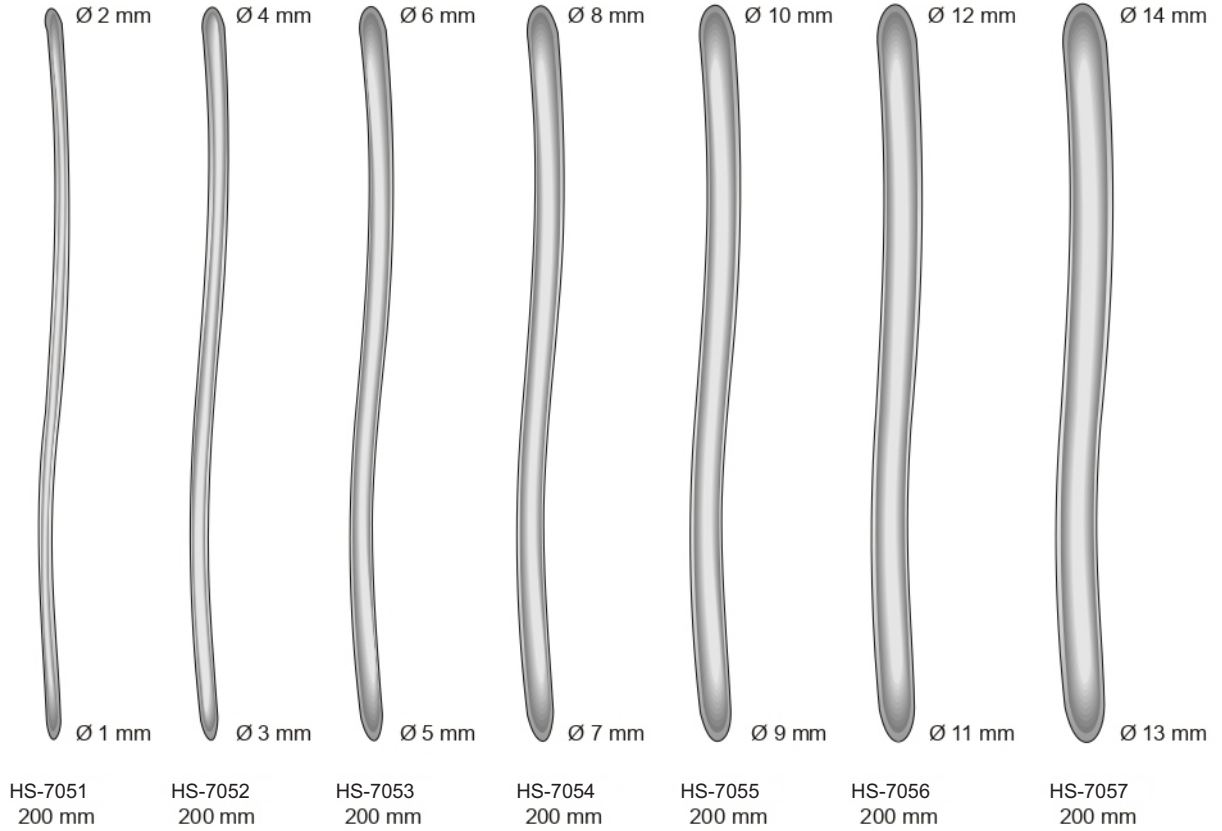

Set completo dilatatori 8 pezzi
 Set complete with 8 pieces
 Satz-Dilatator, komplett, 8 Stück
 Jeu complet avec 8 pieces
 Juego completo con 8 piezas

Pratt Dilatatori
 Pratt Dilatators
 Pratt Dilatatoren
 Pratt Dilatateur
 Pratt Dilatadores

La misura è in French
 Breite in French

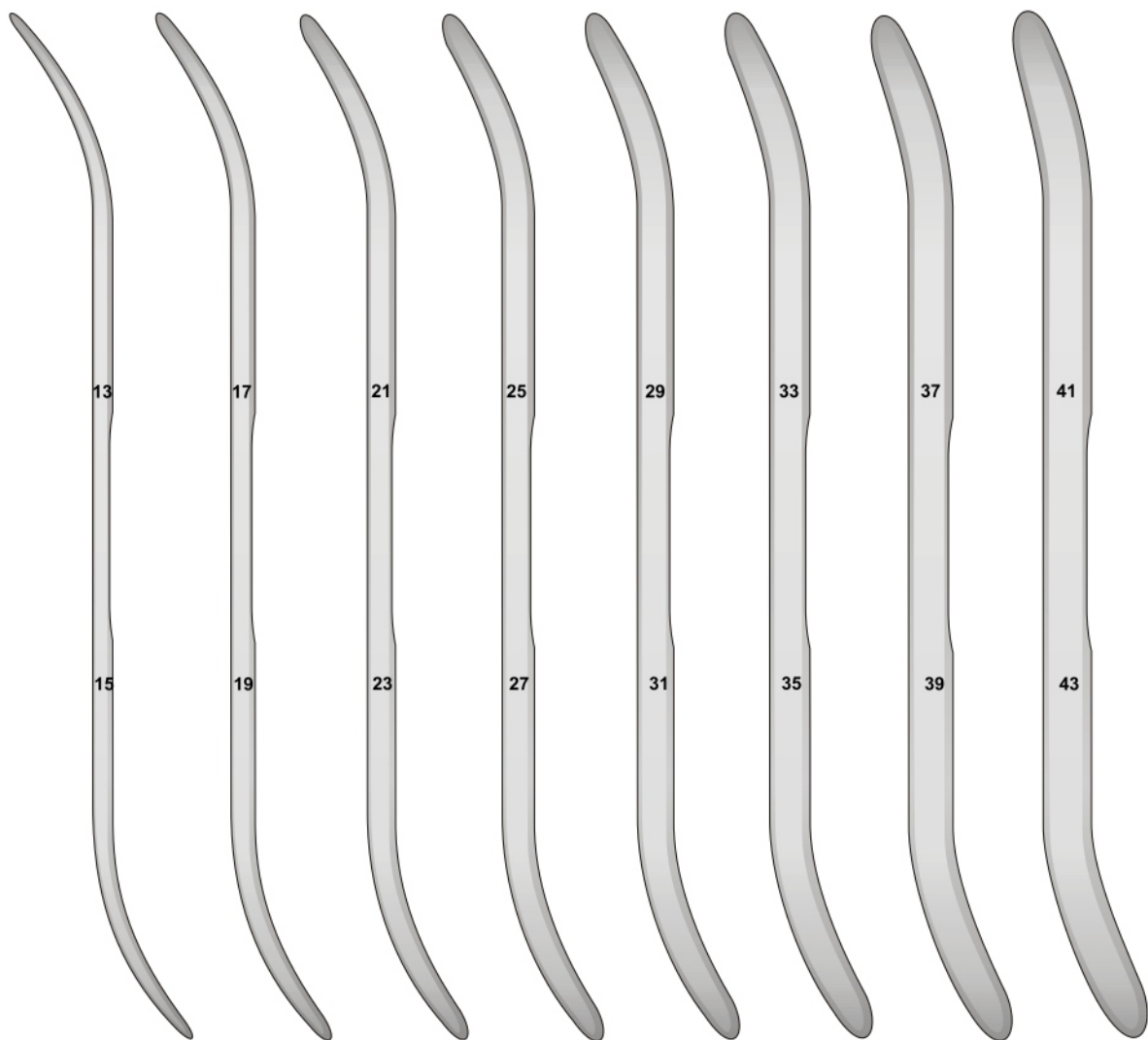

HS-7064	HS-7065	HS-7066	HS-7067	HS-7068	HS-7069	HS-7070	HS-7071
260 mm	260 mm	260 mm	260 mm	260 mm	260 mm	260 mm	260 mm



HS-7072 -01	1 mm	HS-7072 -14	14 mm	HS-7072 -29	1½ mm	HS-7072 -40	14½ mm
HS-7072 -02	2 mm	HS-7072 -15	15 mm	HS-7072 -30	2½ mm	HS-7072 -41	15½ mm
HS-7072 -03	3 mm	HS-7072 -16	16 mm	HS-7072 -31	3½ mm	HS-7072 -42	16½ mm
HS-7072 -04	4 mm	HS-7072 -17	17 mm	HS-7072 -32	4½ mm	HS-7072 -43	17½ mm
HS-7072 -05	5 mm	HS-7072 -18	18 mm	HS-7072 -33	5½ mm		
HS-7072 -06	6 mm	HS-7072 -19	19 mm	HS-7072 -34	6½ mm		
HS-7072 -07	7 mm	HS-7072 -20	20 mm	HS-7072 -35	7½ mm		
HS-7072 -08	8 mm	HS-7072 -21	21 mm	HS-7072 -36	8½ mm		
HS-7072 -09	9 mm	HS-7072 -22	22 mm	HS-7072 -37	9½ mm		
HS-7072 -10	10 mm	HS-7072 -23	23 mm	HS-7072 -38	10½ mm		
HS-7072 -11	11 mm	HS-7072 -24	24 mm	HS-7072 -39	11½ mm		
HS-7072 -12	12 mm	HS-7072 -25	25 mm		12½ mm		
HS-7072 -13	13 mm	HS-7072 -26	26 mm		13½ mm		

HEGAR
HS-7072
185 mm

Fig. 9/10
Ø 4,5/5,0 mm

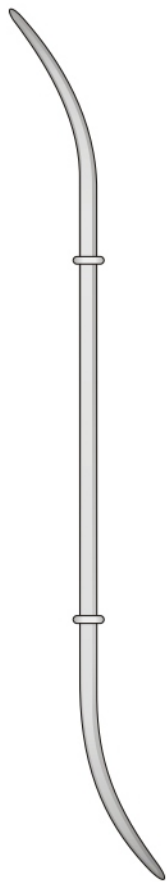

HANK

HS-7073-1
260 mm

Fig. 11/12
Ø 5,5/6,0 mm

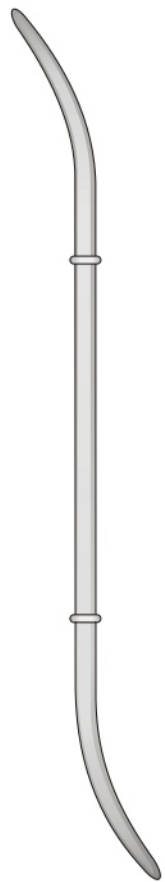

HANK

HS-7073-2
260 mm

Fig. 13/14
Ø 6,5/7,0 mm

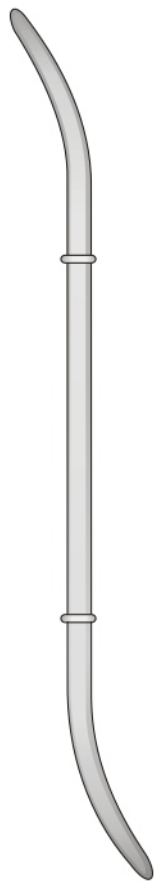

HANK

HS-7073-3
260 mm

Fig. 15/16
Ø 7,5/8,0 mm

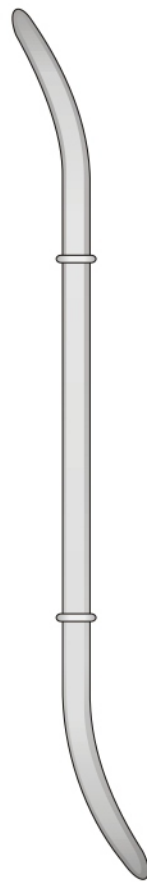

HANK

HS-7073-4
260 mm

Fig. 17/18
Ø 8,5/9,0 mm

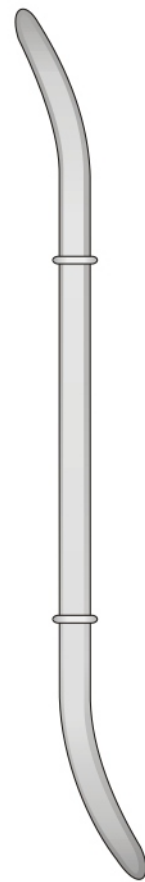

HANK

HS-7073-5
260 mm

Fig. 19/20
Ø 9,5/10 mm

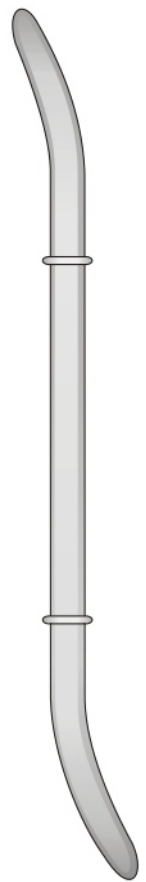

HANK

HS-7073-6
260 mm

Graduati in centimetri
Graduated in centimeters
Zentimetereinteilung
Gradué en centimètres
Graduado en centímetros

Malleabile
Malleable
Biagsam
Malléables
Maleables

Malleabile
Malleable
Biagsam
Malléables
Maleables

Rigido
Rigid
Fest
Rigides
Rigidos

Malleabile
Malleable
Biagsam
Malléables
Maleables

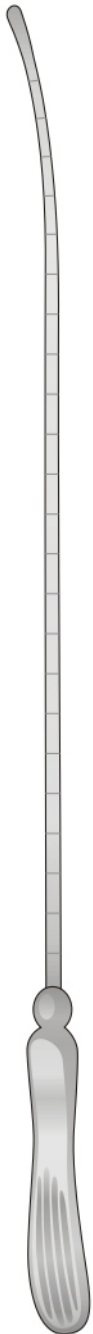

SIMS
HS-7074
320 mm

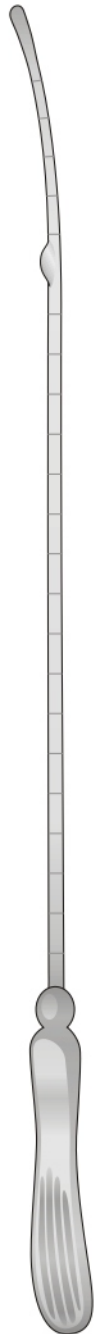

SIMPSON
HS-7075 Ø 3mm
320 mm

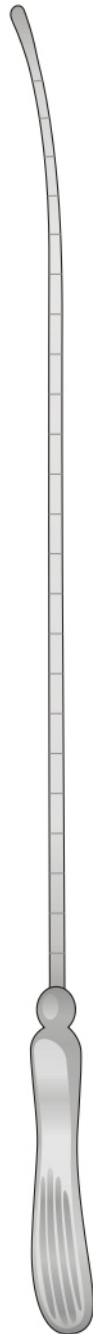

SIMS
HS-7076
320 mm



VALLEIX
HS-7077 Ø 4mm
265 mm



MARTIN
HS-7078 Ø 3mm
300 mm

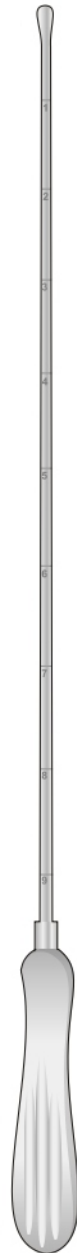

MAYO
HS-7079 Ø 5mm
330 mm

HS-7074-1
Ø 2 mm
HS-7074-2
Ø 3 mm
HS-7074-3
Ø 4 mm

HS-7076-1
Ø 3 mm
HS-7076-2
Ø 4 mm



Amniotomo per la
vescica amniotica
Amniotome for the
amnion bladder
Amniotom für die
Amnionblase
Amniotome pour la
vésicule amniotique
Amniótomo para la
vesícula amniótica

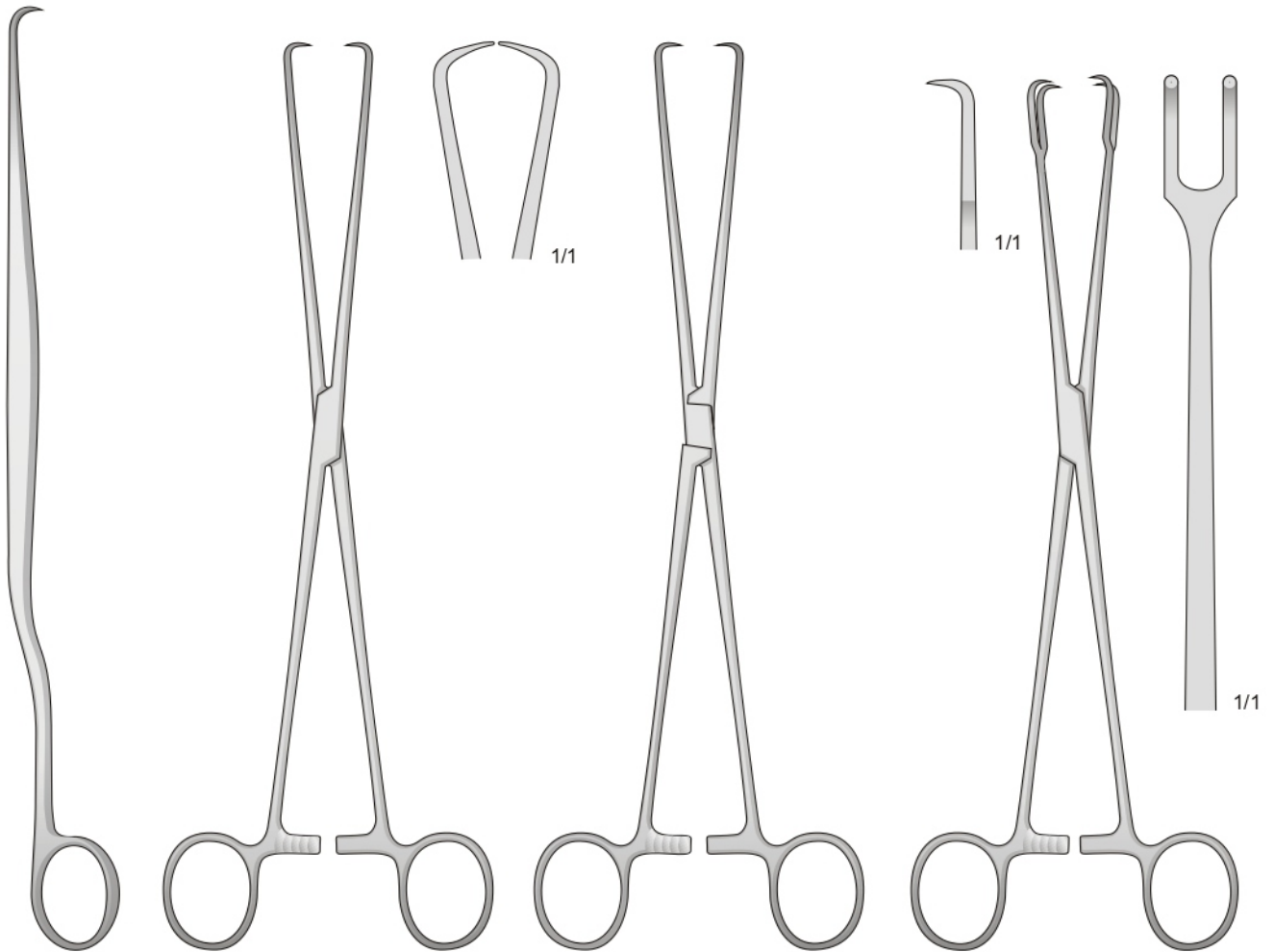

BEACHAM
HS-7080
260 mm

BRAUN
HS-7081
250 mm

POZZI
HS-7082
250 mm

SCHROEDER
HS-7083
240 mm

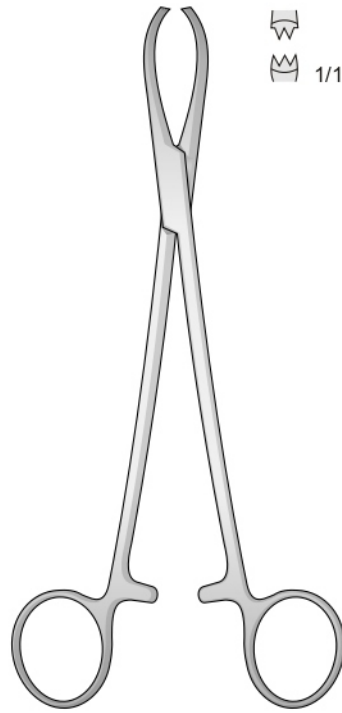

LITTLEWOOD

HS-7084
 185 mm

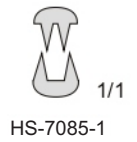
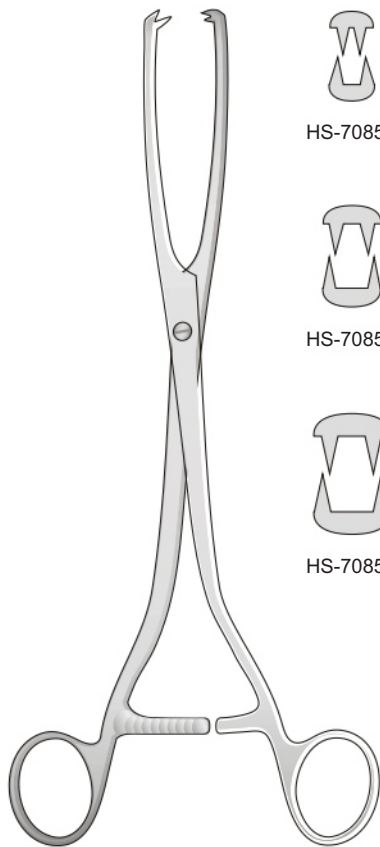

HS-7085-1



HS-7085-2

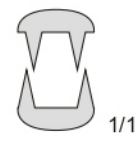

HS-7085-3

MUSEUX
 HS-7085
 240 mm

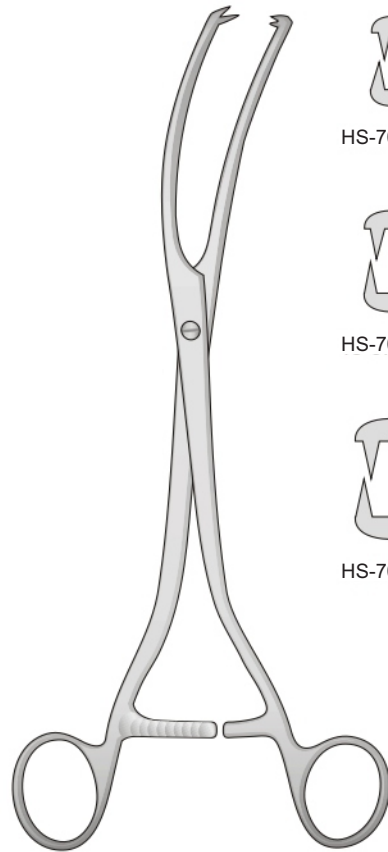

HS-7086-1



HS-7086-2

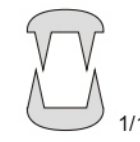

HS-7086-3

MUSEUX
 HS-7086
 240 mm

Pinzette per tube

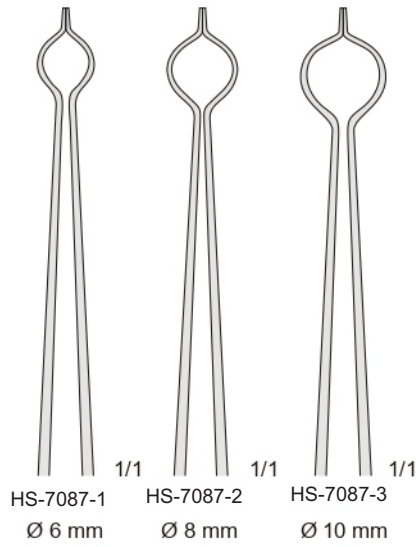

NEUBÜSER
 HS-7087
 200 mm

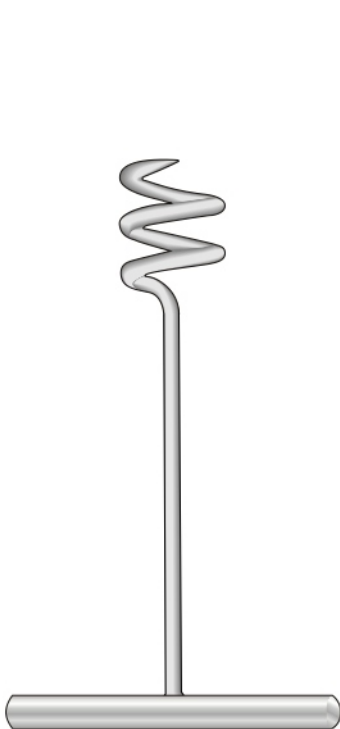

DOYEN
 HS-7088
 150 mm

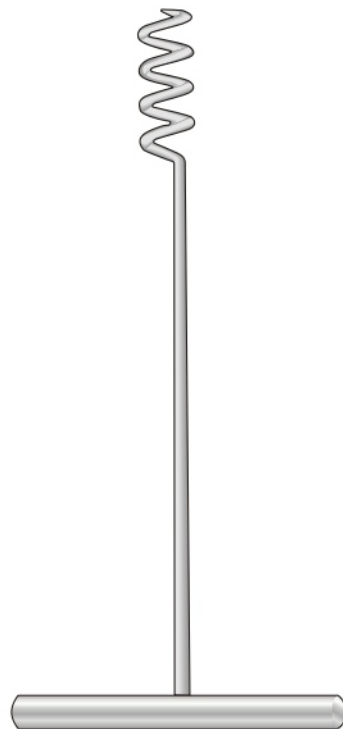

DOYEN
 HS-7089
 170 mm

Curette per biopsia endouterina
Endometrial Biopsy curette
Endometrium-Strichkürette
Curette pour biopsie intra-utérines
Cureta para biopsia endo-uterina

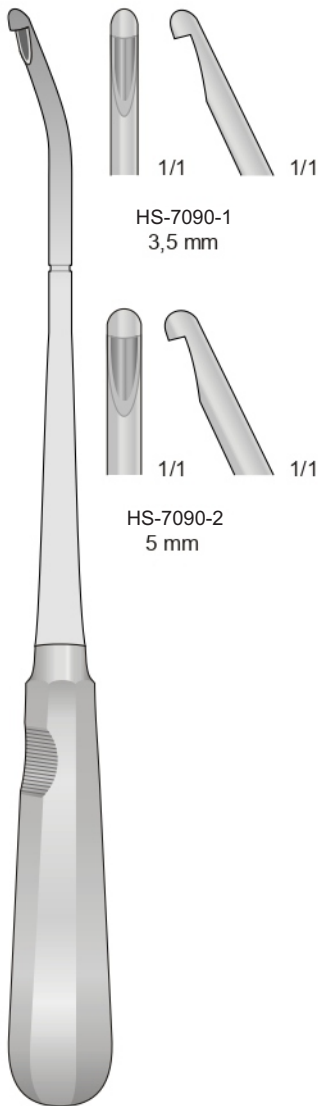

MÜNCHEN
HS-7090
270 mm



NOVAK
HS-7091
230 mm

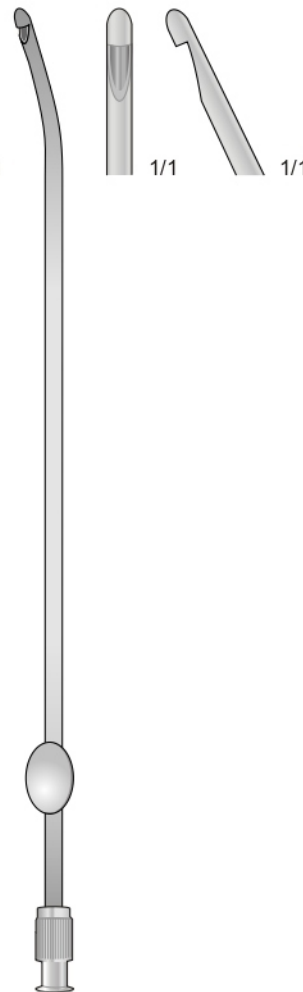

RANDALL
HS-7092
230 mm

Curette per biopsia endocervicale
Endocervical Biopsy Curettes
Endocervix-Biopsieküretten

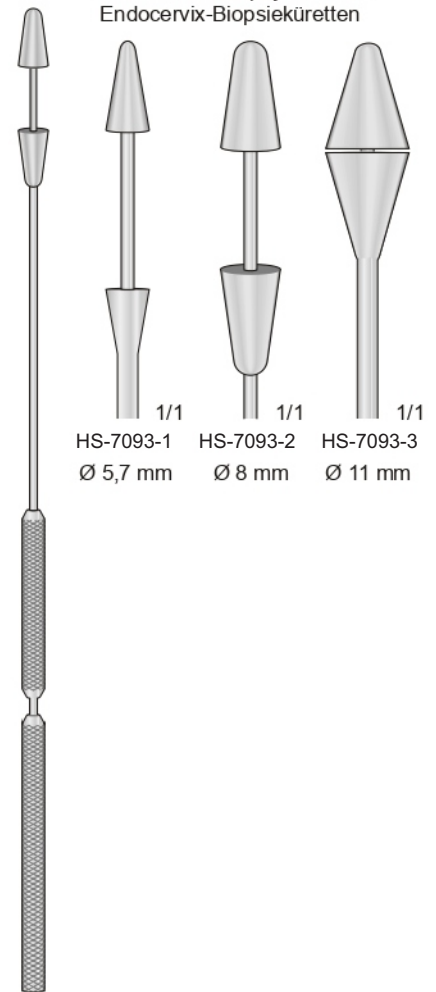

GUSBERG
HS-7093
240 mm

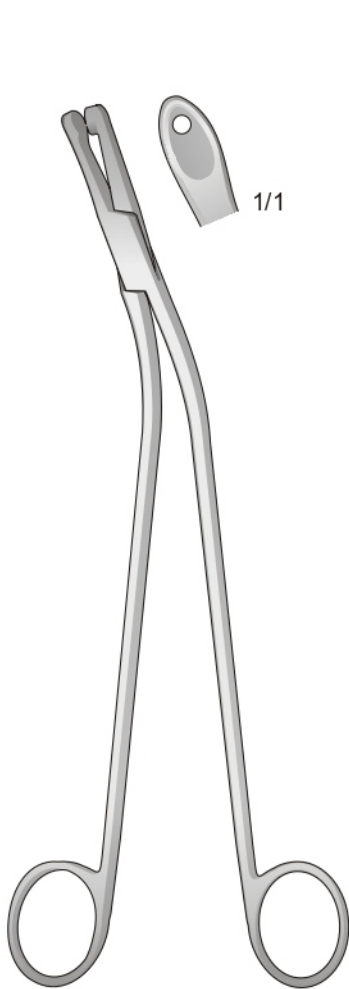

GELLHORN
HS-7094
230 mm

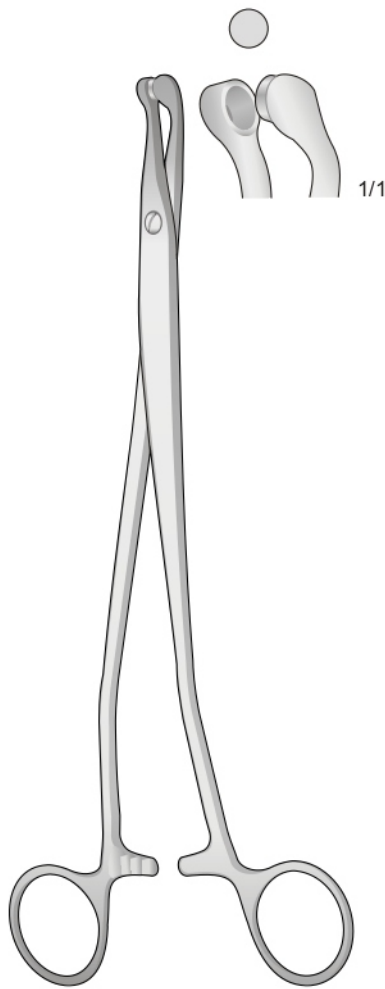

THOMS-GAYLOR
HS-7095
240 mm

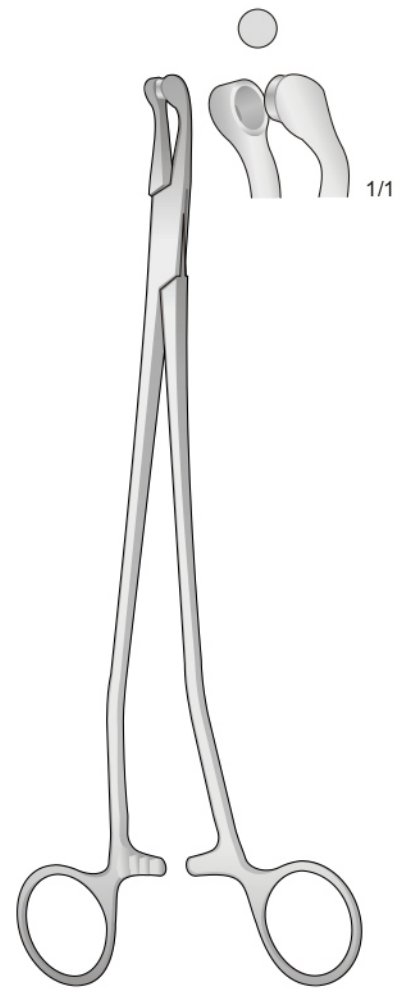

THOMS-GAYLOR
HS-7095-1 220 mm
HS-7095-2 240 mm

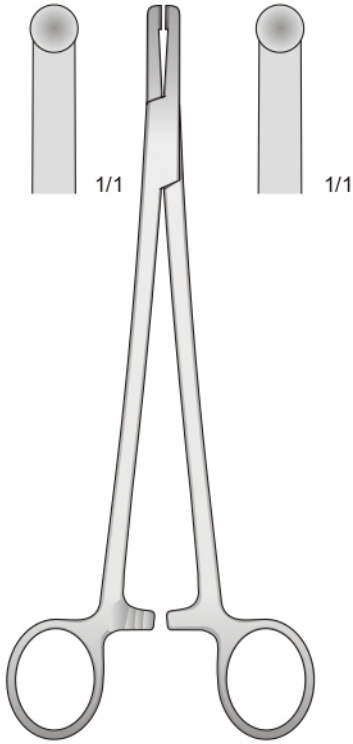

HS-7096
205 mm

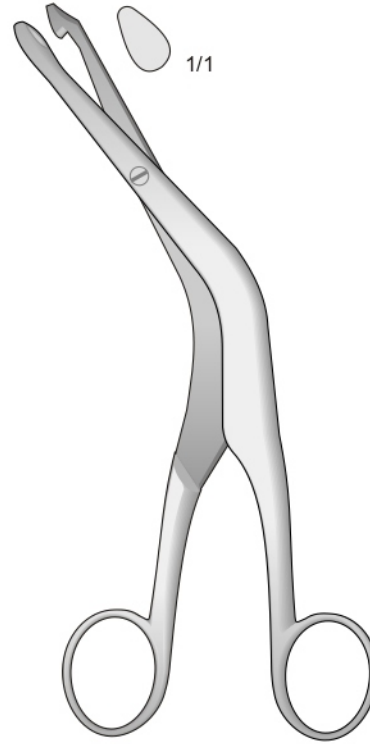

FAURE
HS-7097
210 mm

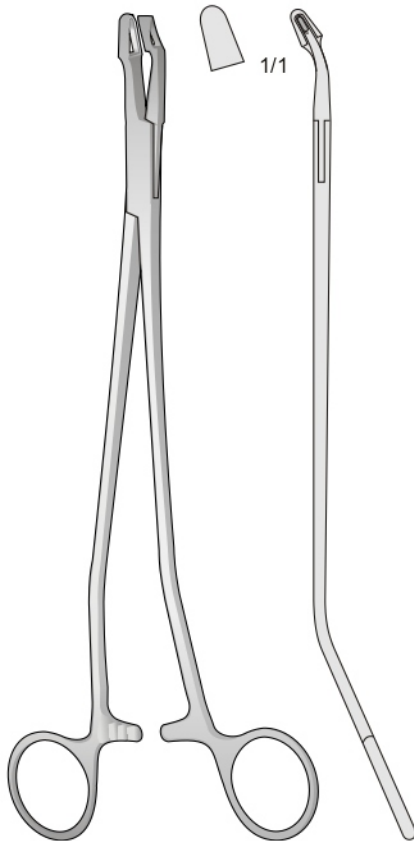

VAN DOREN
HS-7098
250 mm

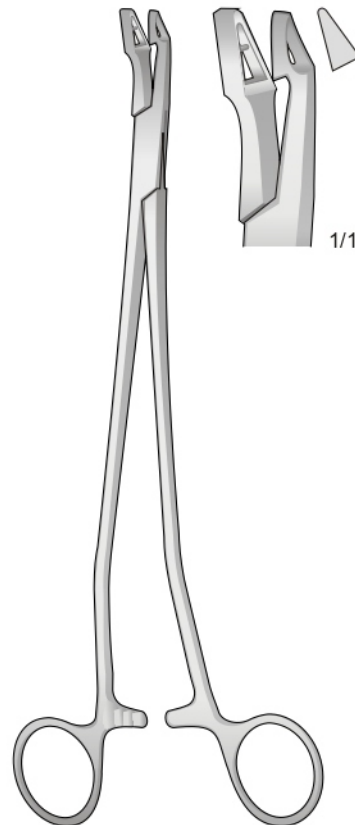

VAN DOREN
HS-7099
240 mm

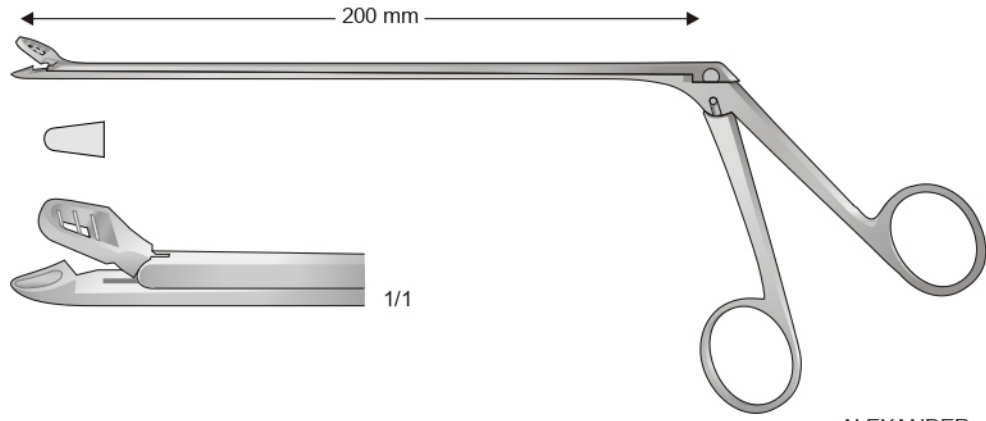

ALEXANDER
HS-7100

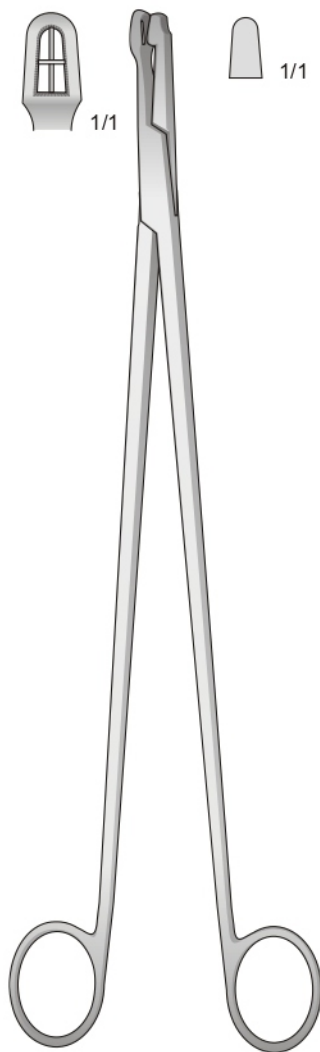

SCHUBERT
HS-7101-1 210 mm
HS-7101-2 290 mm

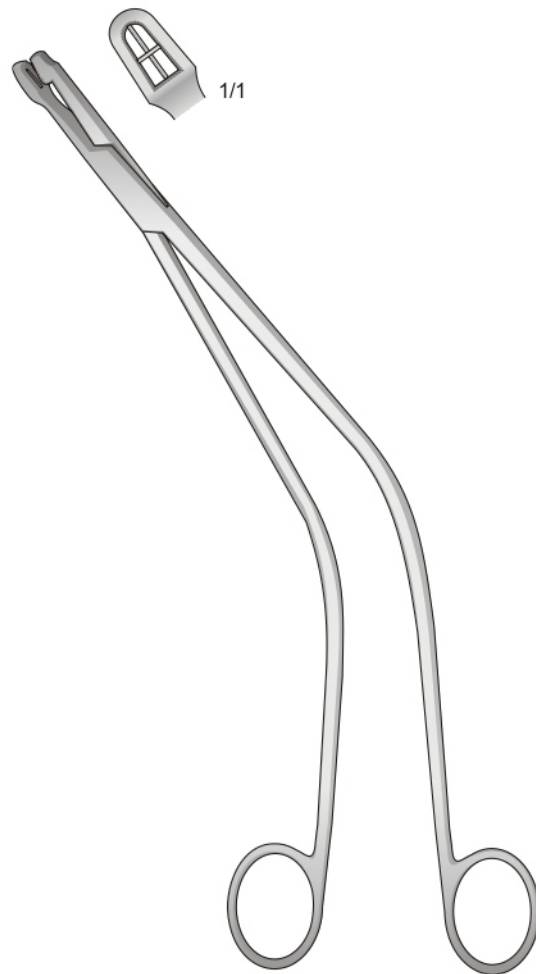

SCHUBERT
HS-7102
260 mm

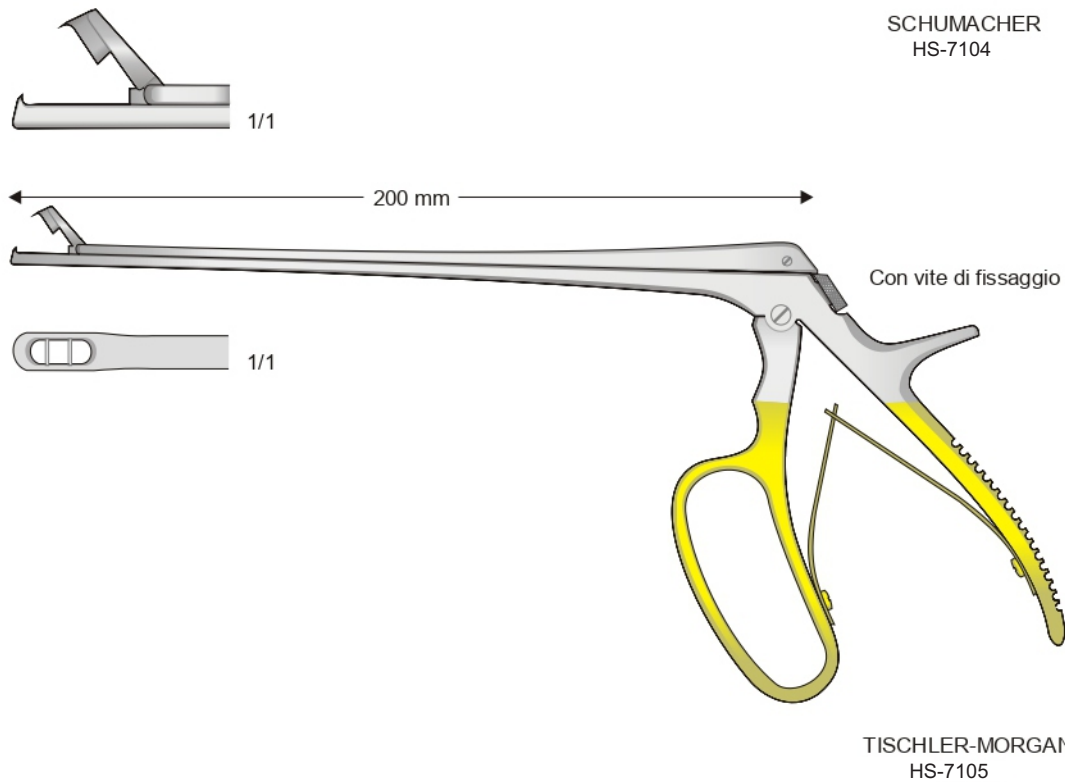
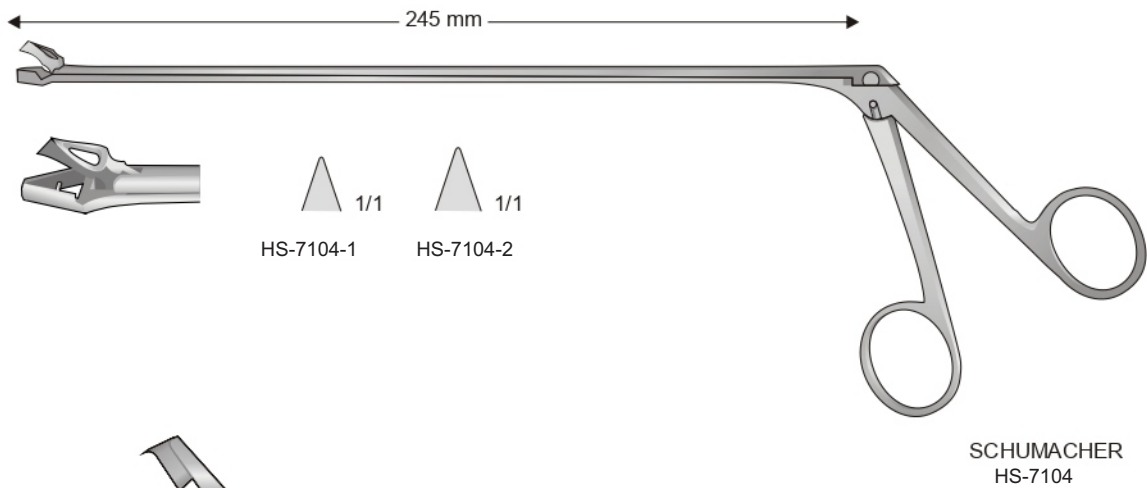
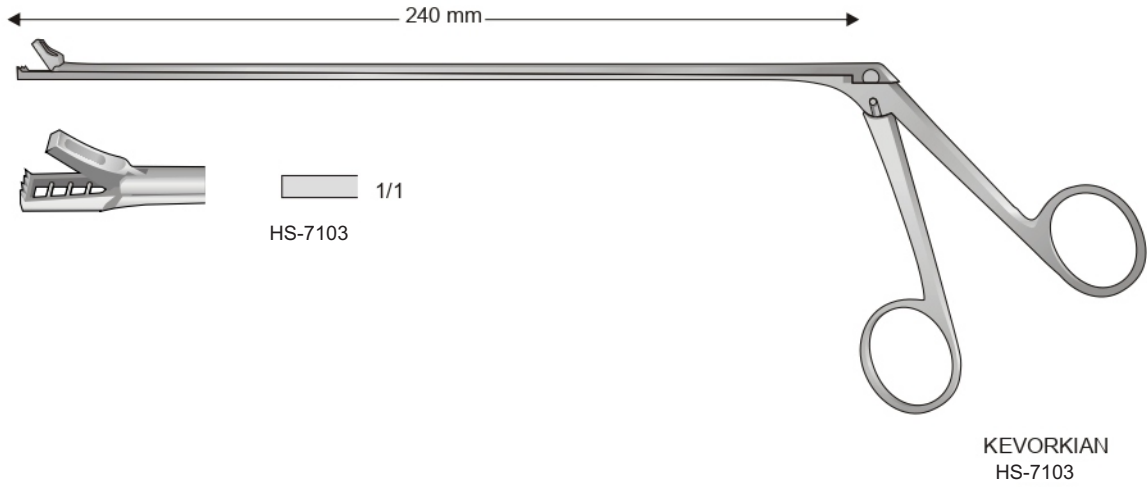

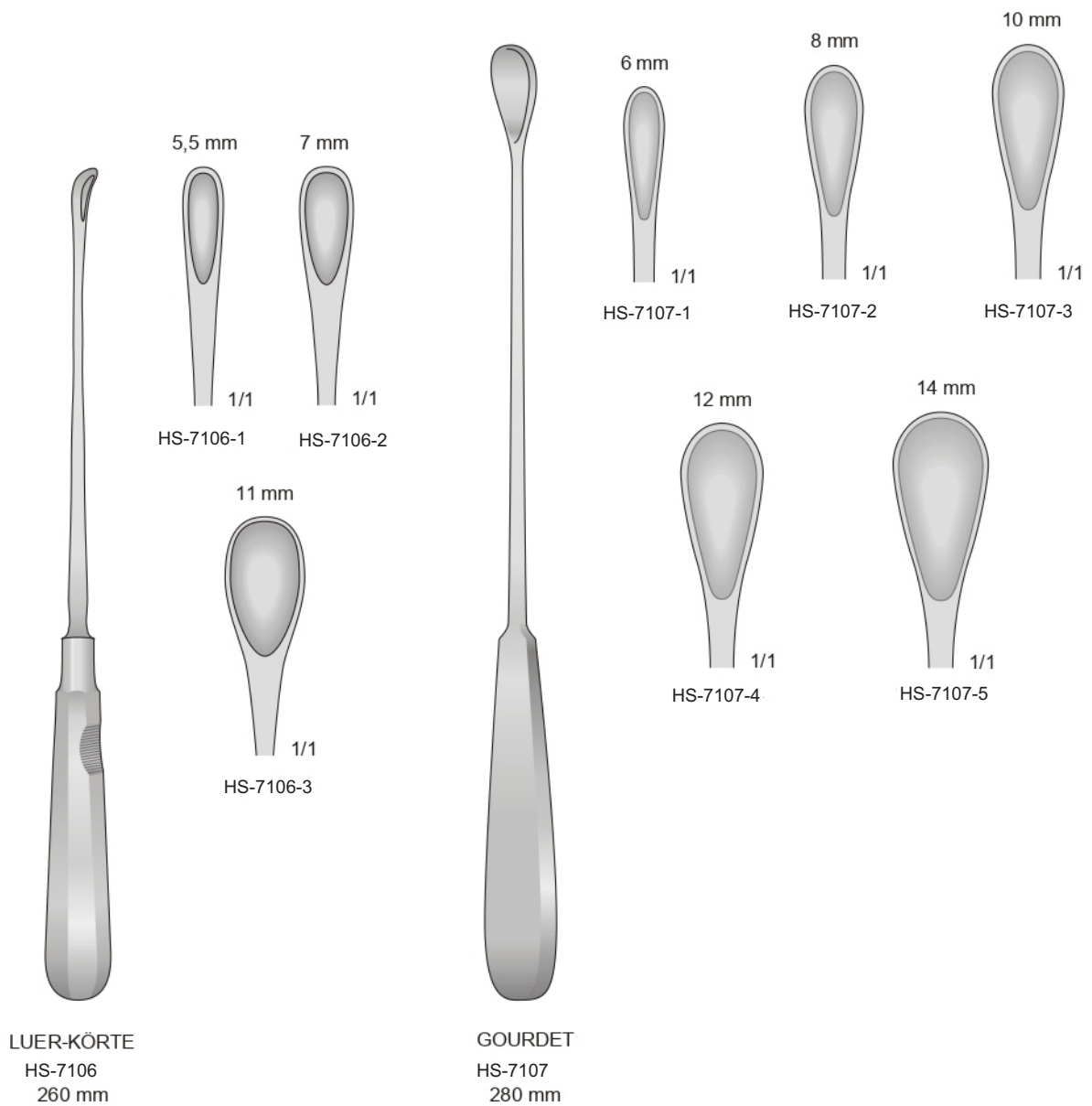

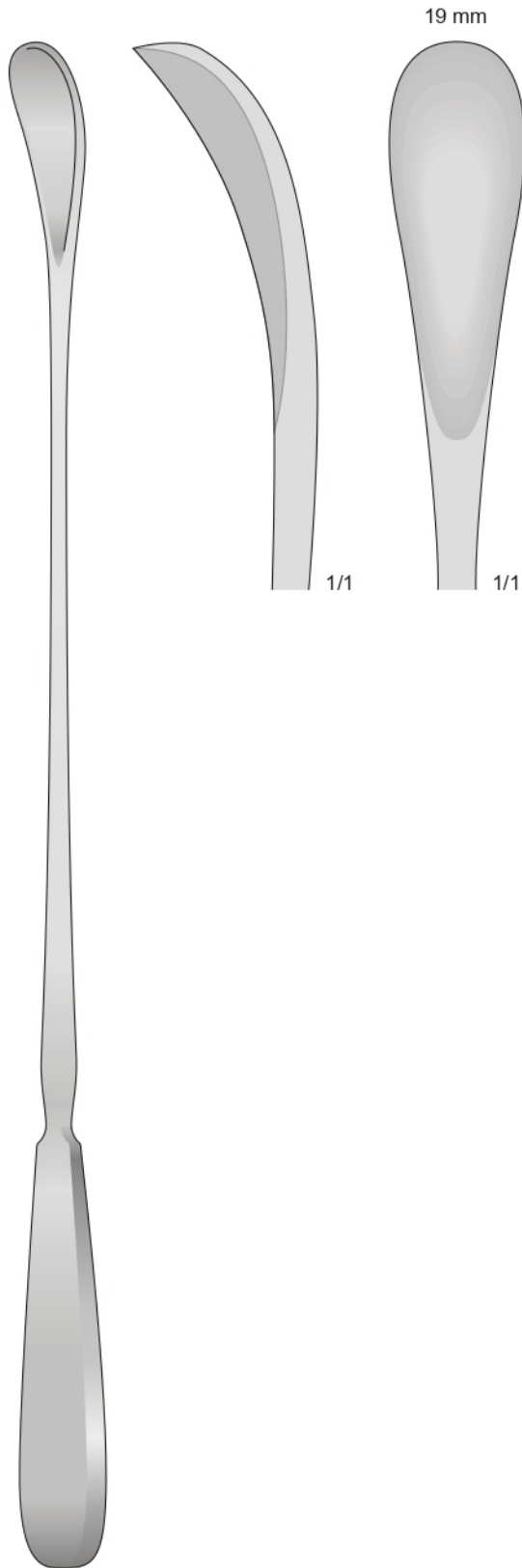

WALLICH
HS-7108
420 mm

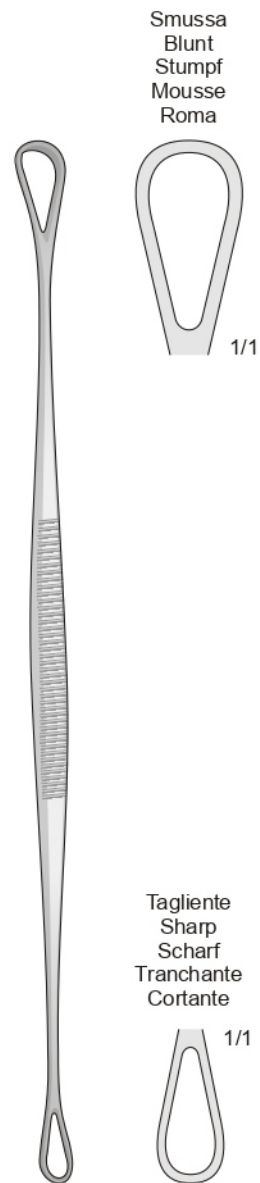

BLAKE
HS-7109
275 mm



Taglienti
Scharf
Scharf
Tranchantes
Cortantes

Smussa
Blunt
Stumpf
Mousse
Romas

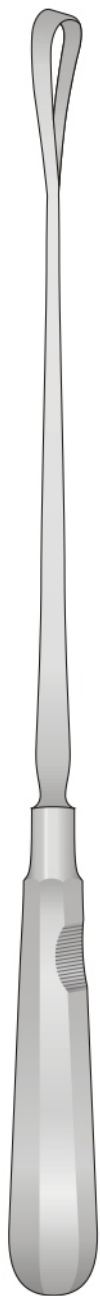

RECAMIER
HS-7110
310 mm

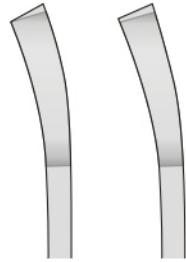
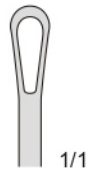

Fig. 1



1/1

Fig. 2



1/1

Fig. 3



1/1

Fig. 4



1/1

Fig. 5



1/1

Fig. 6

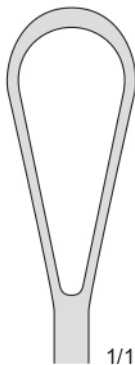

1/1

Fig. 7



1/1

Fig. 8



1/1

Fig.	Larghezza Width Breite	Taglienti-rigide Sharp-rigid Scharf-fest Tranchantes-rigides Cortantes-rigidas	Smusse-rigide Blunt-rigid Stumpf-fest Mousse-rigides Romas-rigidas
1	4 mm	HS-7110 -01	HS-7110 -09
2	6 mm	HS-7110 -02	HS-7110 -10
3	8 mm	HS-7110 -03	HS-7110 -11
4	10 mm	HS-7110 -04	HS-7110 -12
5	12 mm	HS-7110 -05	HS-7110 -13
6	14 mm	HS-7110 -06	HS-7110 -14
7	16 mm	HS-7110 -07	HS-7110 -15
8	18 mm	HS-7110 -08	HS-7110 -16



BUMM
HS-7111
310 mm

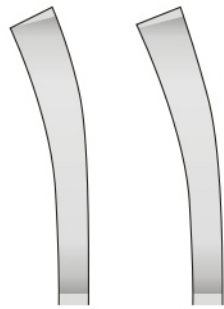

Tagliente
Scharp
Scharf
Tranchantes
Cortantes

Smussa
Blunt
Stumpf
Mousse
Romas

Malleabile
Malleable
Biegsam
Souples
Maleables

Fig. 3



Fig. 4



1/1

Fig.	Larghezza Width Breite	Taglienti Sharp Scharf Tranchantes Cortantes	Smusse Blunt Stumpf Mousse Romas
3	18 mm	HS-7111-1	HS-7111-3
4	20 mm	HS-7111-2	HS-7111-4



Fig.	Larghezza Breite Width	Smusse malleabili - Blunt malleable Stumpf biegsam - Mousse malléables Romas maleables
0	16 mm	HS-7112 -01
1	18 mm	HS-7112 -02
2	19,5 mm	HS-7112 -03
3	21,5 mm	HS-7112 -04
4	23,5 mm	HS-7112 -05
5	26 mm	HS-7112 -06
6	28,5 mm	HS-7112 -07

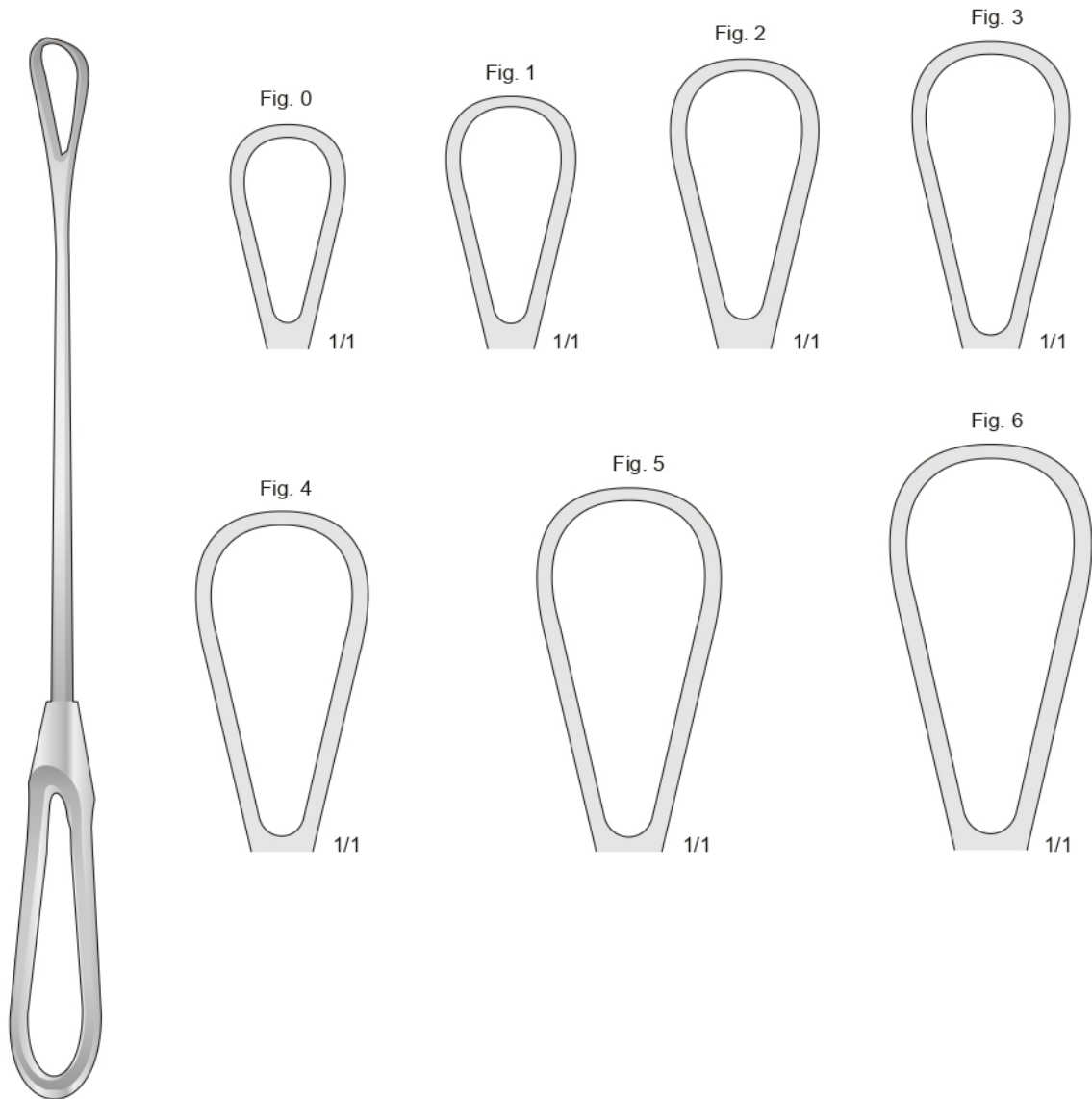

BUMM
HS-7112
290 mm

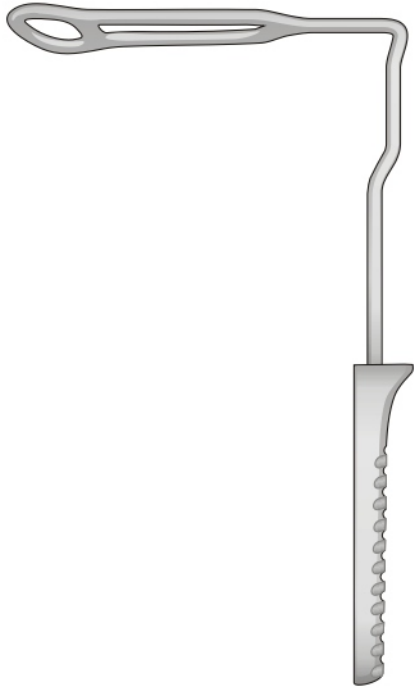

GENTOFT
HS-7113
210 mm

Set 2 pezzi
Set 2 pieces
Set 2 Stück
Set 2 pièces
Set 2 piezos
15-930

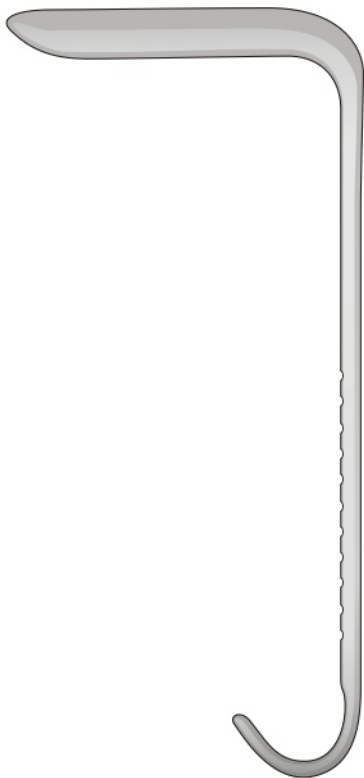

FENO
HS-7114
230 mm

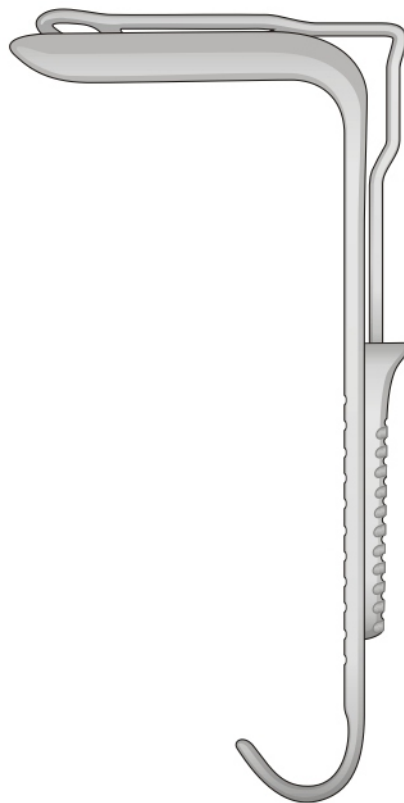

HS-7115
230 mm

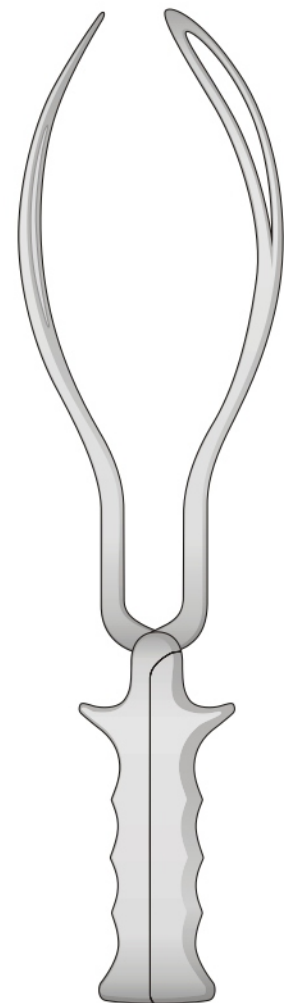

SIMPSON-BRAUN
HS-7116
365 mm

**Manufacturer & Exporter
Of Surgical, Dental & Beauty Instruments.**



Health Fast Surgical

Surgical Manufacturer Company

+92 (342) 880 9017

+92 (342) 880 9017

info@healthfastsurgical.com

www.healthfastsurgical.com

Dogra Khurd, P.O Harrar Sialkot-51310 Pakistan.



ISO
9001:2008

