

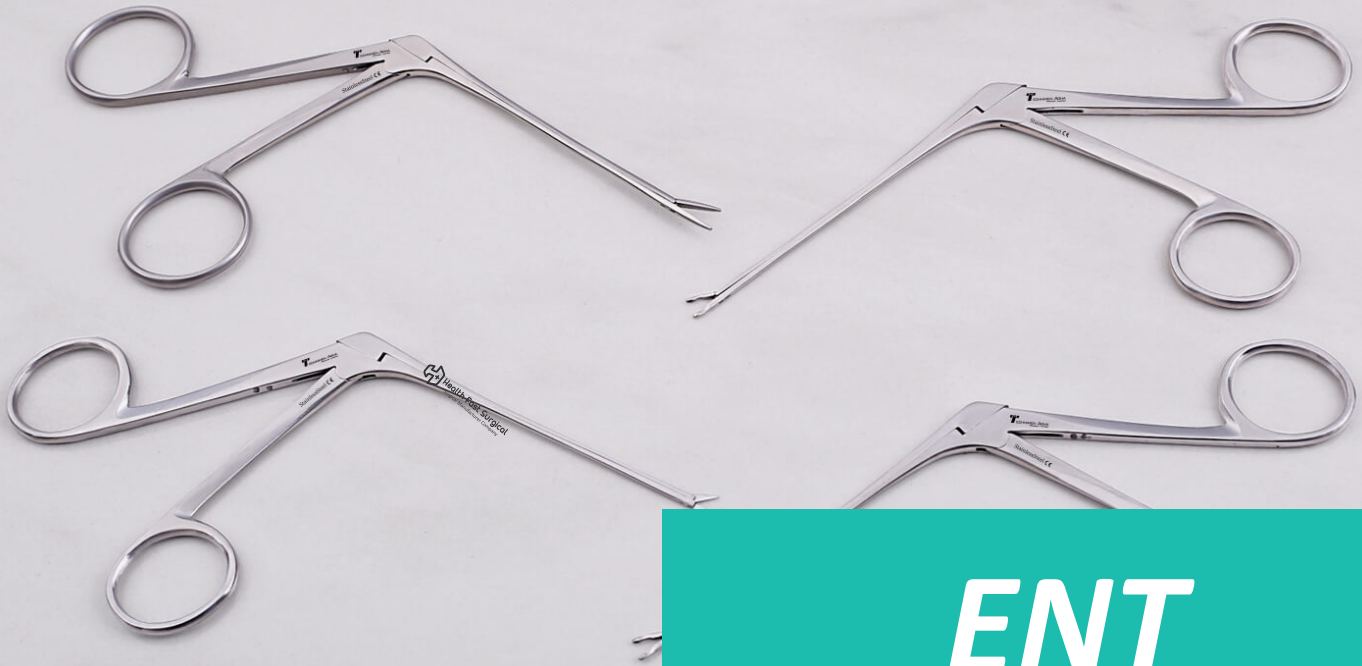

Health Fast Surgical
Surgical Manufacturer Company



ENT
Otolaryngology

Surgical
INSTRUMENTS CATALOGUE



Per adulti - For adults
Für Erwachsene - Pour adultes
Para adultos

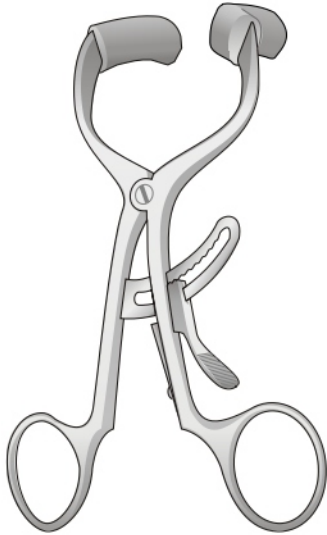

DOYEN-JANSEN
HS-8001
140 mm

Per adulti - For adults
Für Erwachsene - Pour adultes
Para adultos

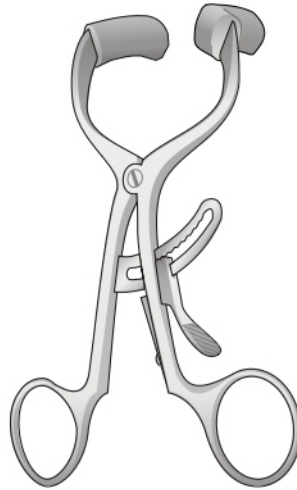

DOYEN-COLLIN
HS-8002
120 mm

Per bambini
For children
Für kinder
Pour enfants
Para niños

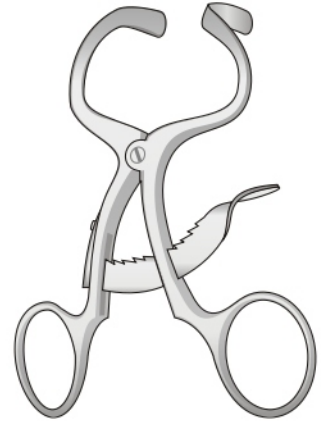

MOLT
HS-8003
100 mm

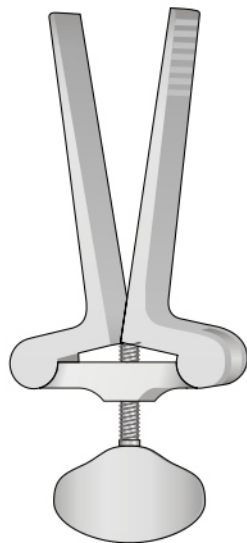

HEISTER
HS-8004
135 mm

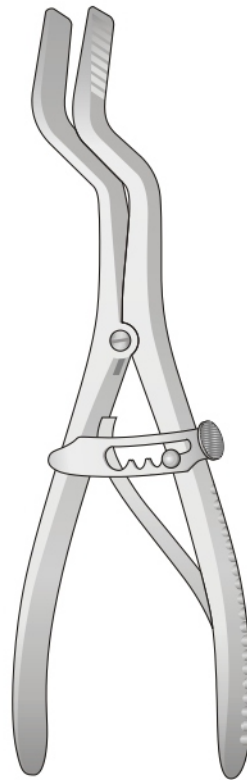

ROSER KÖNIG
HS-8005
185 mm



Apribocca con aspirazione
Mouth gag with suction
Mundsperrer mit Absauger

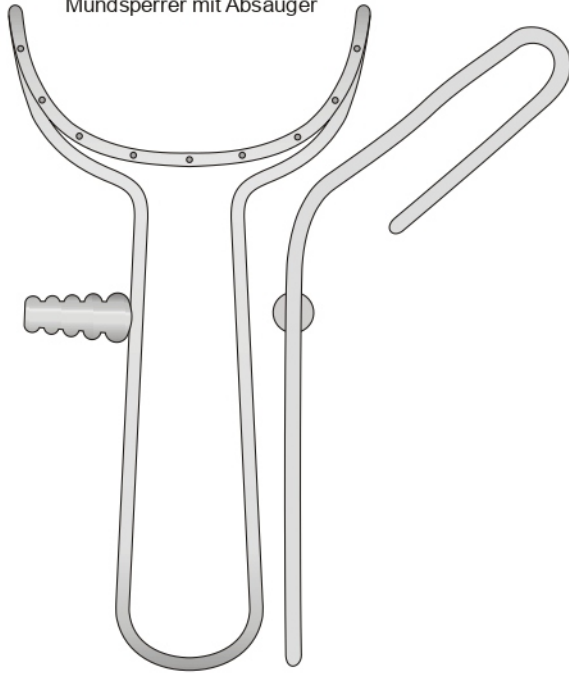

HS-8006
140 mm

Apribocca senza aspirazione
Mouth gag without suction
Mundsperrer ohne Absauger

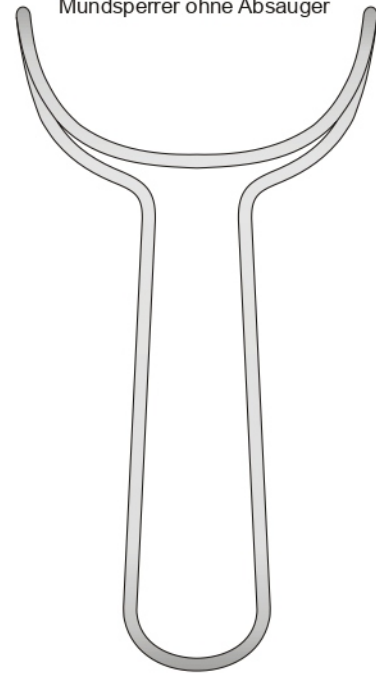

HS-8007
150 mm

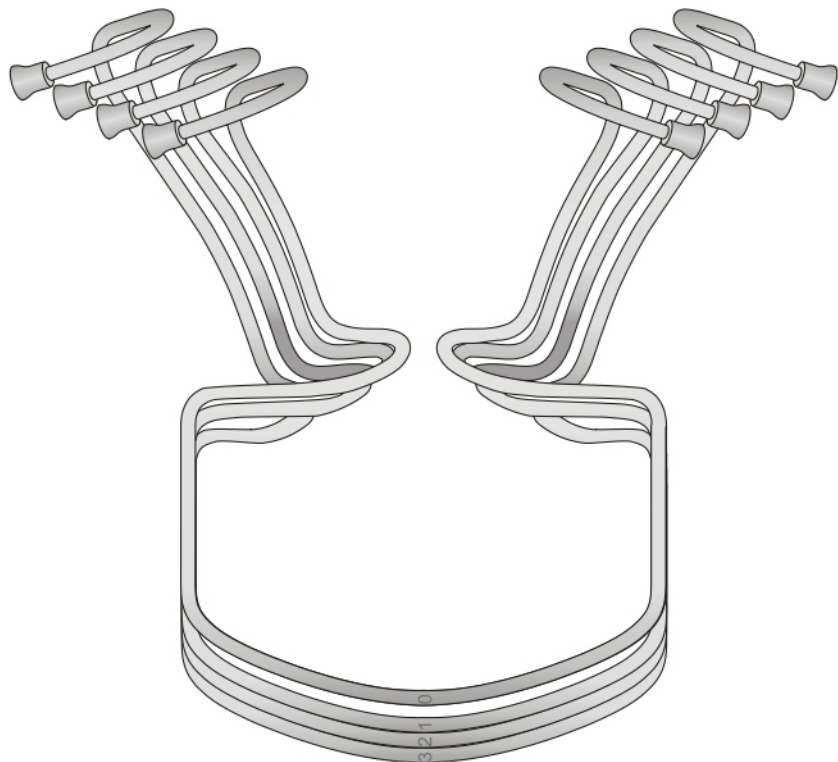
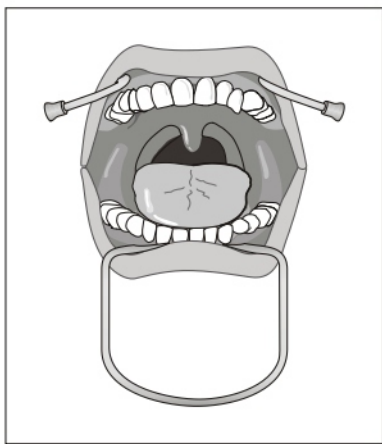

ORINGER

HS-8008	Fig. 0 100 x 95 mm	Per bambini
HS-8009	Fig. 1 115 x 105 mm	Per adulti
HS-8010	Fig. 2 115 x 110 mm	Per adulti
HS-8011	Fig. 3 125 x 115 mm	Per adulti

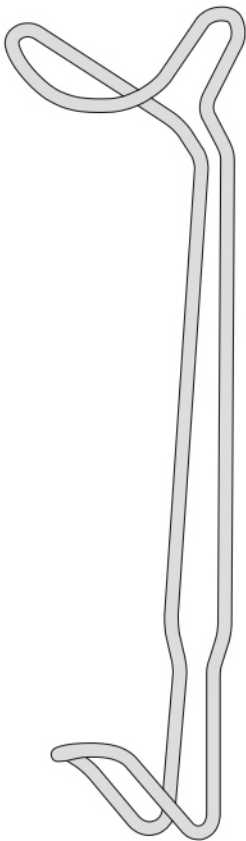

HS-8012
210 mm

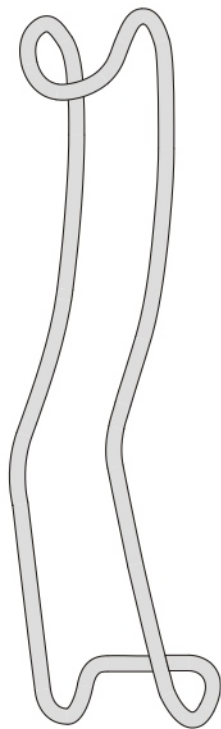

STERNBERG
HS-8013
160 mm

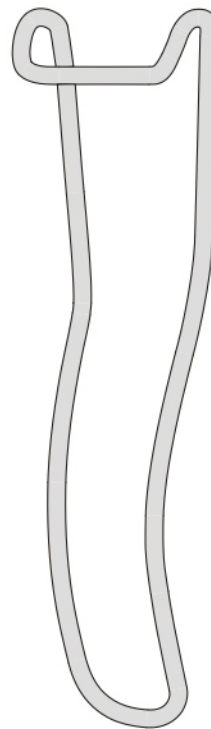

STERNBERG
HS-8014
160 mm

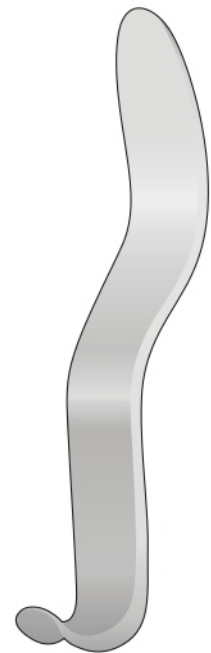

MINNESOTA
HS-8015
140 mm

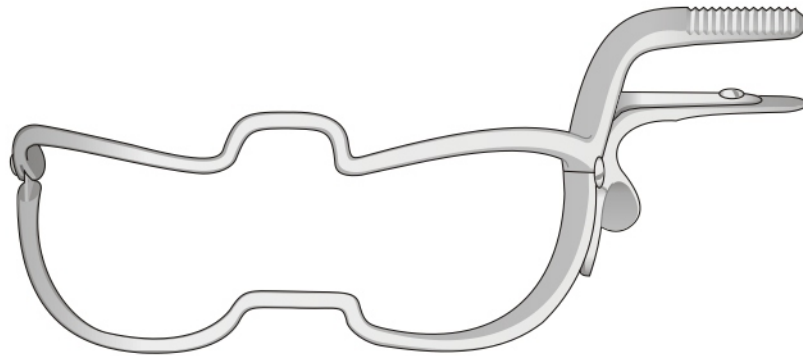

WHITEHEAD-JENNINGS

- HS-8016 90 mm
- HS-8017 110 mm
- HS-8018 130 mm
- HS-8019 150 mm

Apribocca solo
Gag only
Sperrer allein
Manche et cadreseuls
Apre-boca suelto

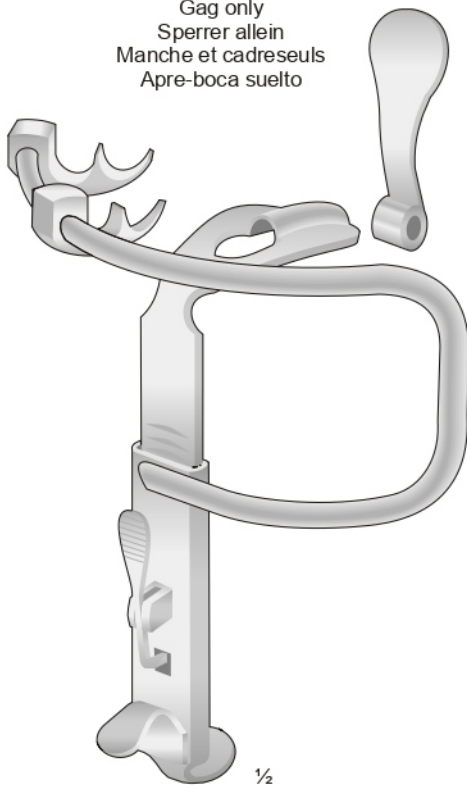

KILNER-DOUGHTY
HS-8023

Fig. 1

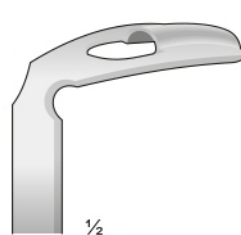

HS-8020
8 x 65 mm

Fig. 2

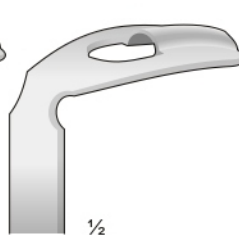

HS-8021
32 x 75 mm

Fig. 3

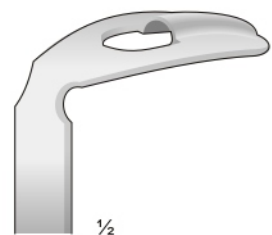

HS-8022
37 x 80 mm

KILNER-DOUGHTY
13-220

Completo con 3 abbassalingua
Complete with 3 tongue depressors
Komplet mit 3 Zungenspatel
Complet avec 3 abaisse-langues
Completo con 3 abaja lengua



Mouth Gags

Apribocca solo
Gag only
Sperrer allein
Manche et cadreseuls
Apre-boca suelto

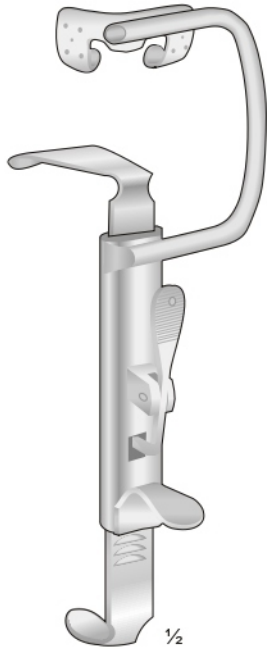

DAVIS-BOYLE
HS-8023-1

DAVIS-BOYLE
13-240
Completo con 5 abbassalingua
Complete with 5 tongue depressors
Komplet mit 5 Zungenspatel
Complet avec 5 abaisse-langues
Completo con 5 abaja lengua

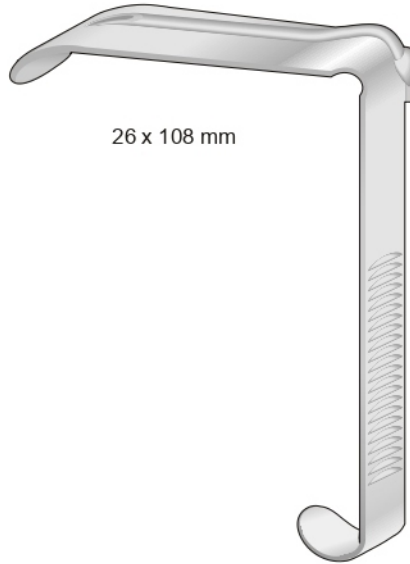

26 x 108 mm

HS-8023-2

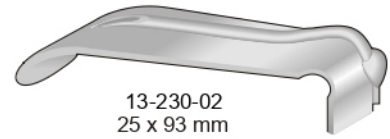

13-230-02
25 x 93 mm



HS-8023-3
24 x 80 mm

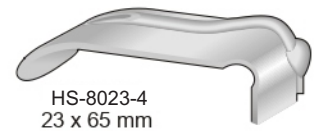

HS-8023-4
23 x 65 mm



HS-8023-5
21 x 30 mm

Mc-IVOR
13-260
Completo di 3 abbassalingua
Complete with 3 tongue depressors
Komplet mit 3 Zungenspatel
Complet avec 3 abaisse-langues
Completo con 3 abaja lengua

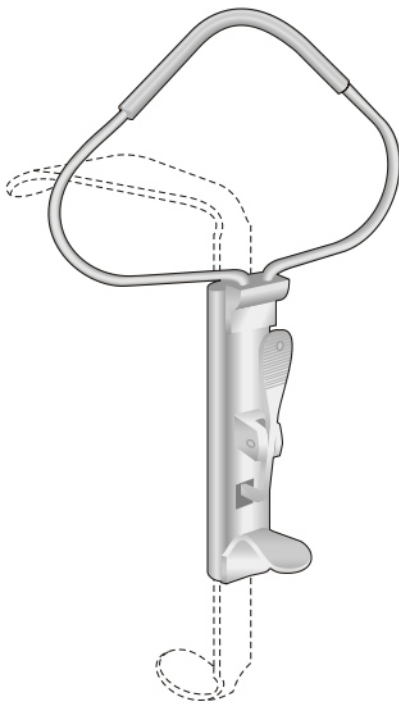

Mc-IVOR
HS-8024-1



26 x 100 mm

HS-8024-2

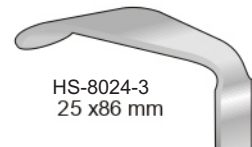

HS-8024-3
25 x 86 mm

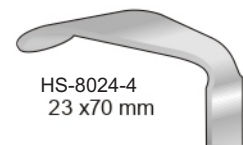

HS-8024-4
23 x 70 mm

Telaio Dingmann con
due apriguancia

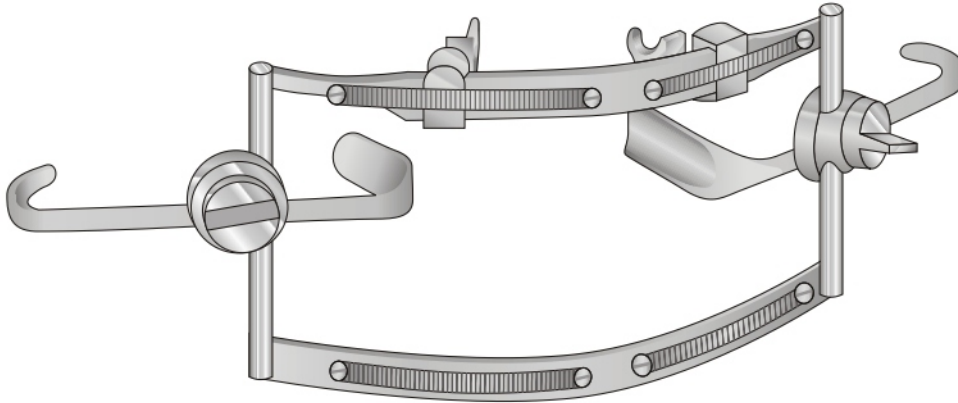

HS-8025-1

Abbassalingua
Tongue depressor
Zungenspatel
Abaisse langues
Bejalenguas

Fig. 1

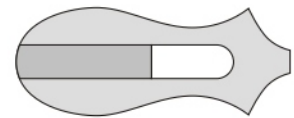

HS-8025-2
piccolo

Fig. 2

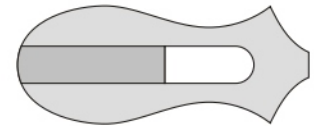

HS-8025-3
medio

Fig. 3

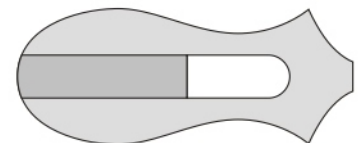

HS-8025-4
grande

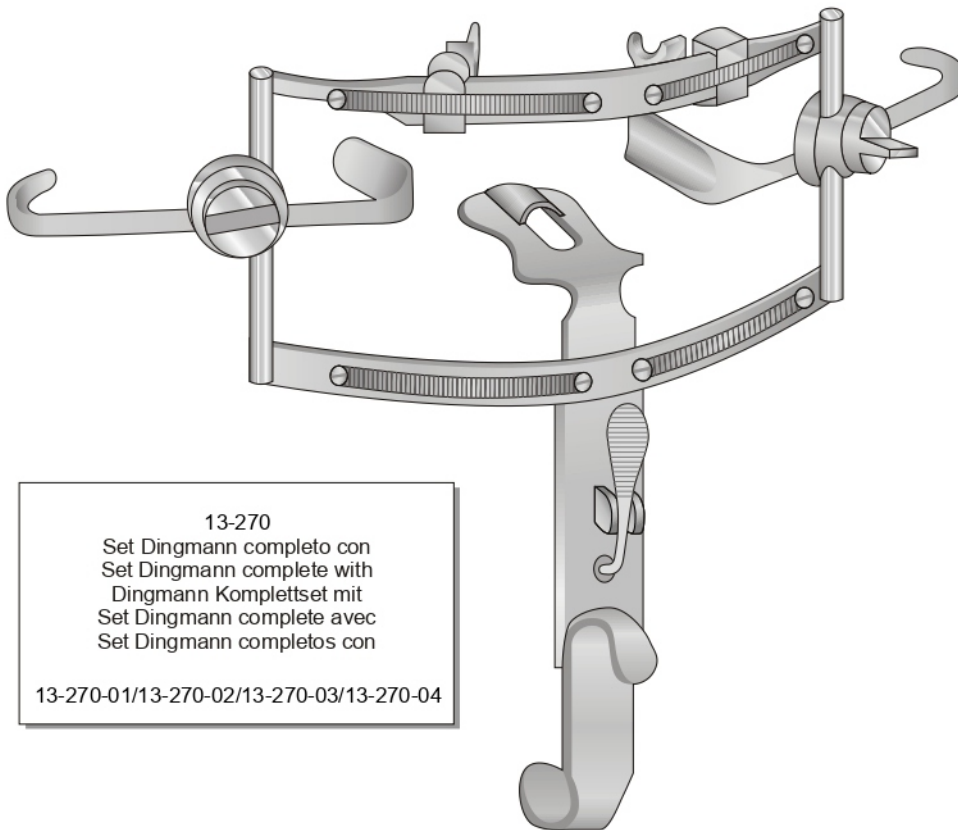

13-270
Set Dingmann completo con
Set Dingmann complete with
Dingmann Kompletset mit
Set Dingmann complete avec
Set Dingmann completos con

13-270-01/13-270-02/13-270-03/13-270-04

DINGMANN
HS-8025
Set completo

Spatulas Malleable



HS-8026-1
110 mm



HS-8026-2
160 mm



HS-8027
195 mm

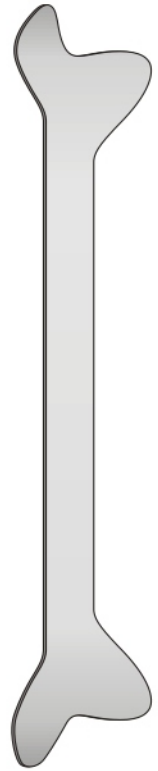

HS-8028
180 mm

Spatole inox malleabili
Spatulas malleable

Spatole Inox malleabili antiriflesso nere
Spatulas malleable black anodized

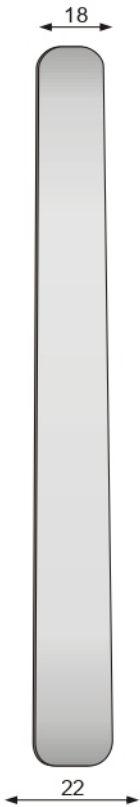

HS-8028-1
200 mm

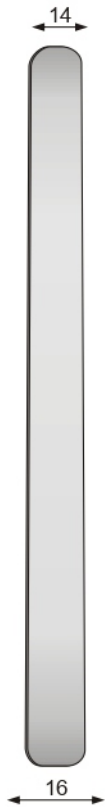

HS-8028-2
200 mm



HS-8028-3
240 mm



HS-8028-4
200 mm

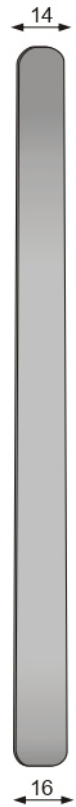

HS-8028-5
200 mm

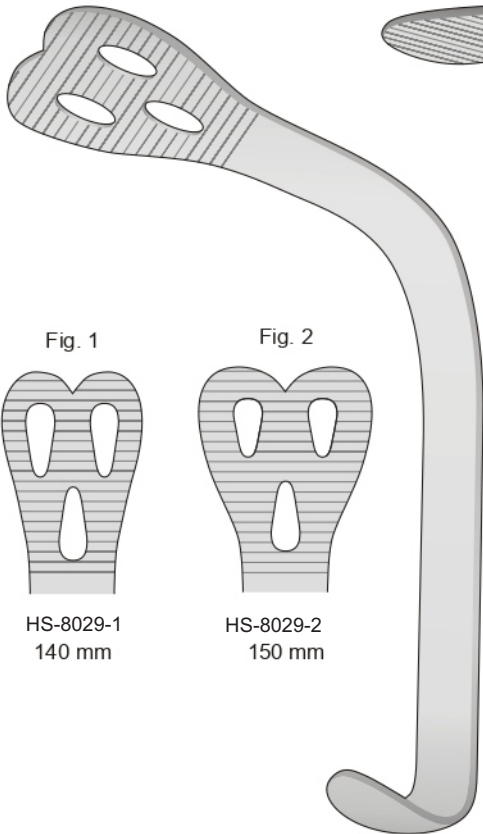
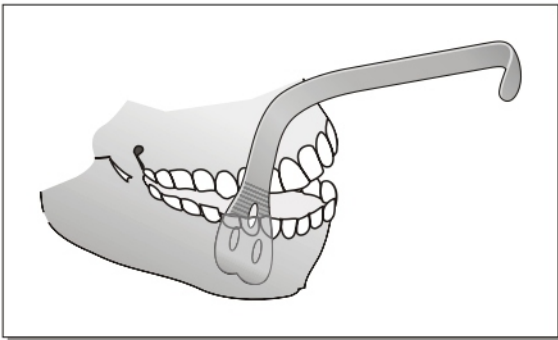

Fig. 1

Fig. 2

HS-8029-1
140 mm

HS-8029-2
150 mm

WIEDER
HS-8029

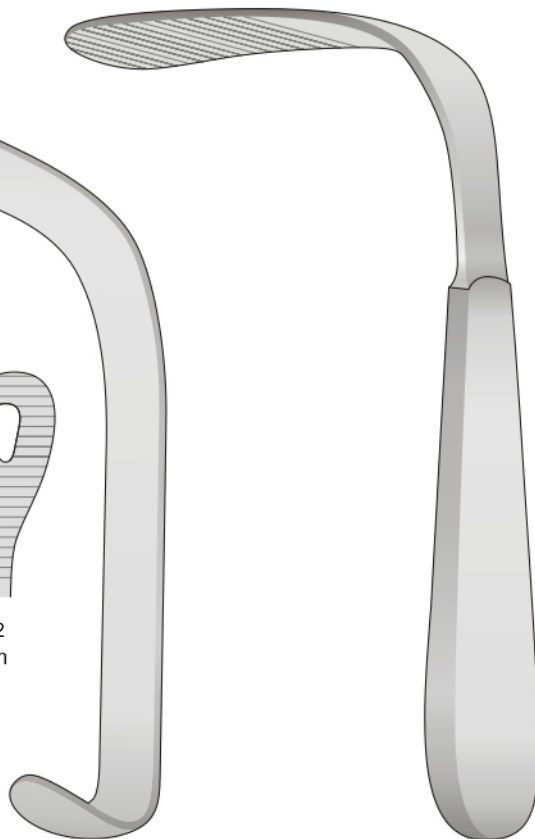

TOBOLD
HS-8030
145 mm

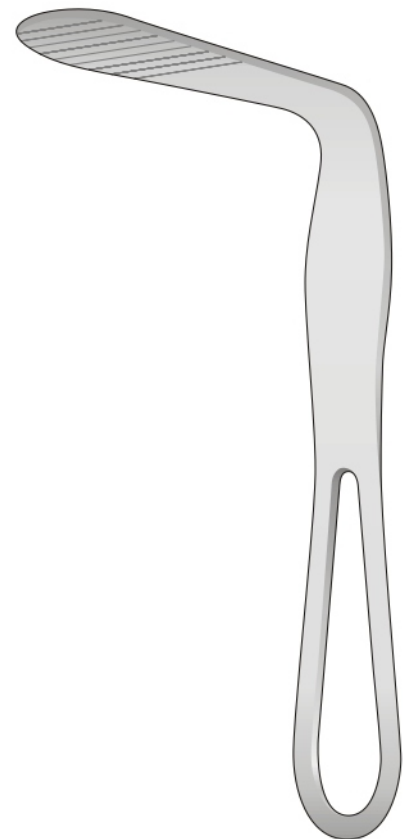

HARTMANN
HS-8031
150 mm

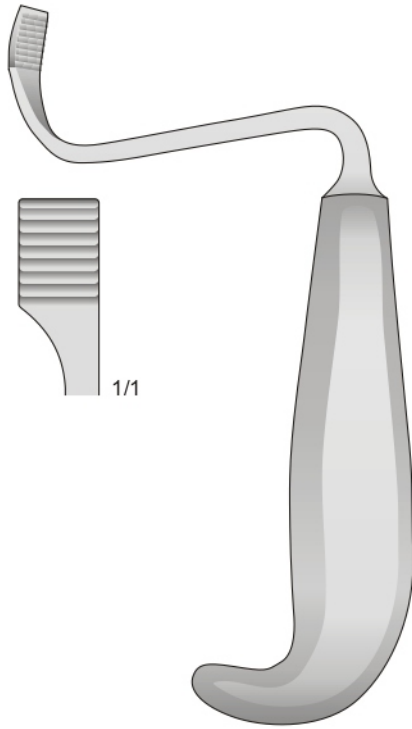

TESSIER
HS-8032-1
150 mm

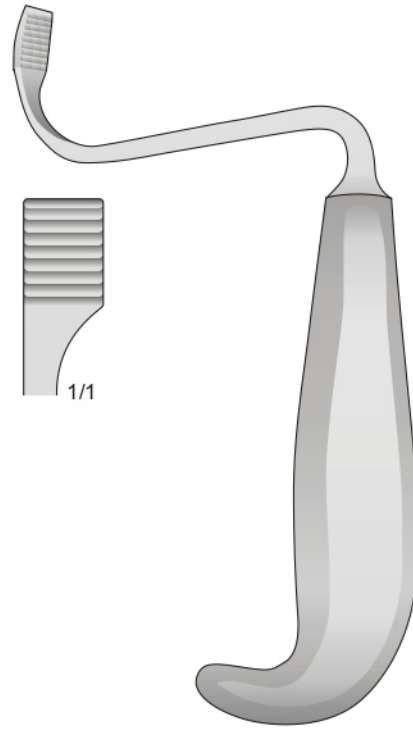

TESSIER
HS-8032-2
150 mm

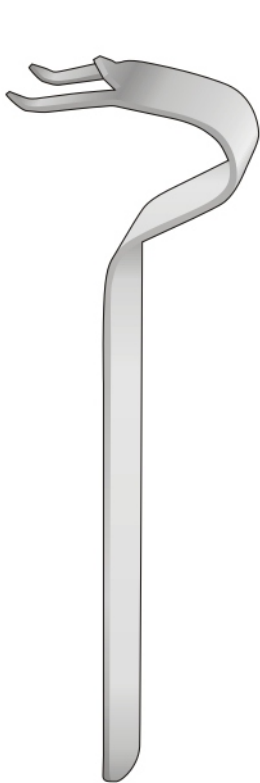

OBWEGESER
HS-8033
155 mm

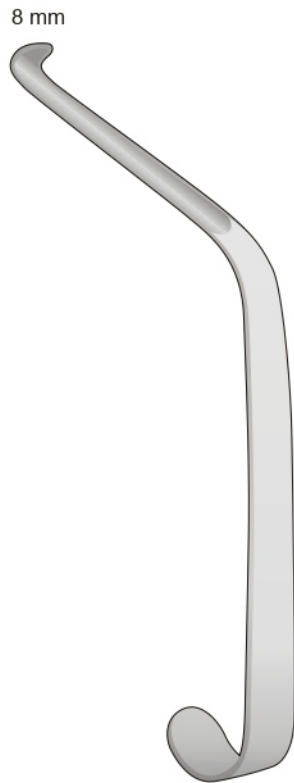

OBWEGESER
HS-8034-1
165 mm

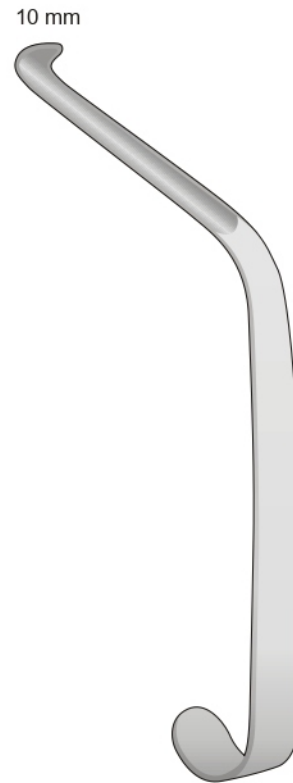

OBWEGESER
HS-8034-2
165 mm



6 x 13 mm

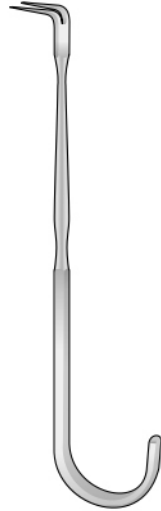

DUNN-DAUTREY
HS-8035-1
130 mm

8 x 18 mm



DUNN-DAUTREY
HS-8035-2
125 mm

Posteriore



1/1

Anteriore

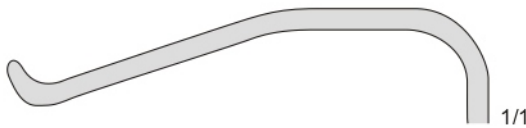

1/1

Superiore

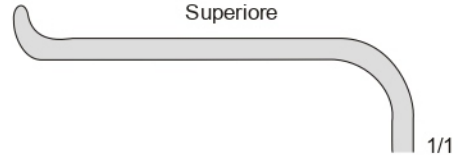

1/1

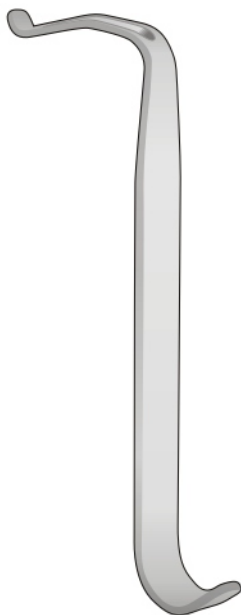

DUNN-DAUTREY
HS-8036-1 6,5 x 50 mm
140 mm

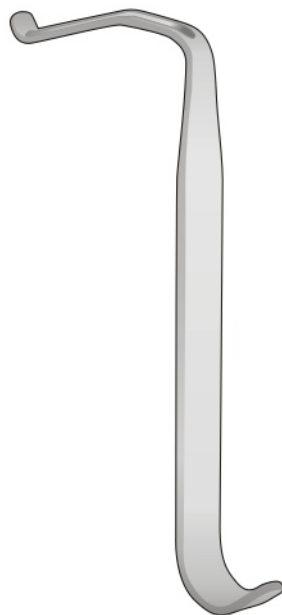

DUNN-DAUTREY
HS-8036-2 6,5 x 60 mm
140 mm

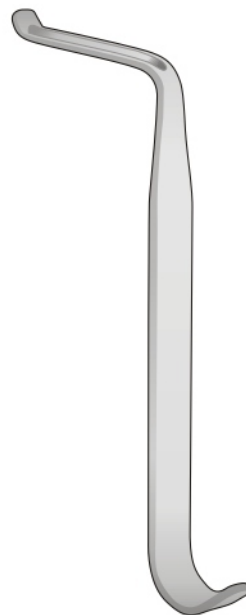

DUNN-DAUTREY
HS-8036-3 8 x 50 mm
140 mm

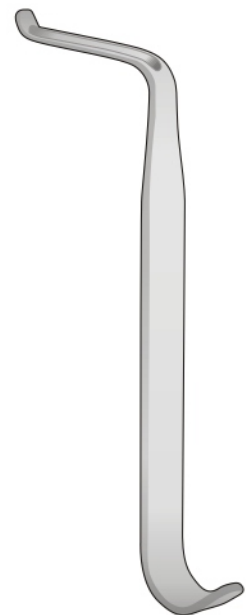

DUNN-DAUTREY
HS-8036-4 5 x 50 mm
140 mm

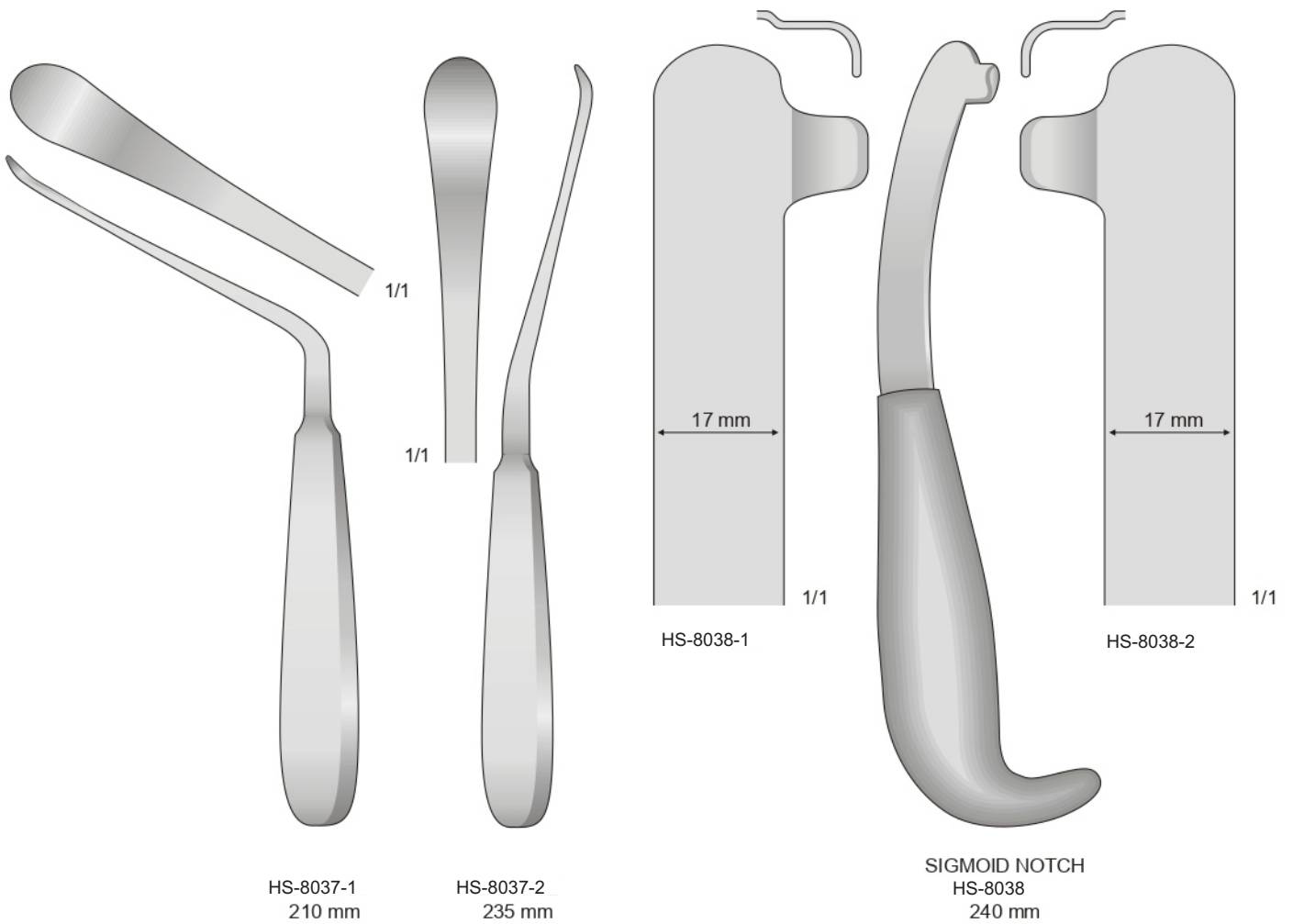

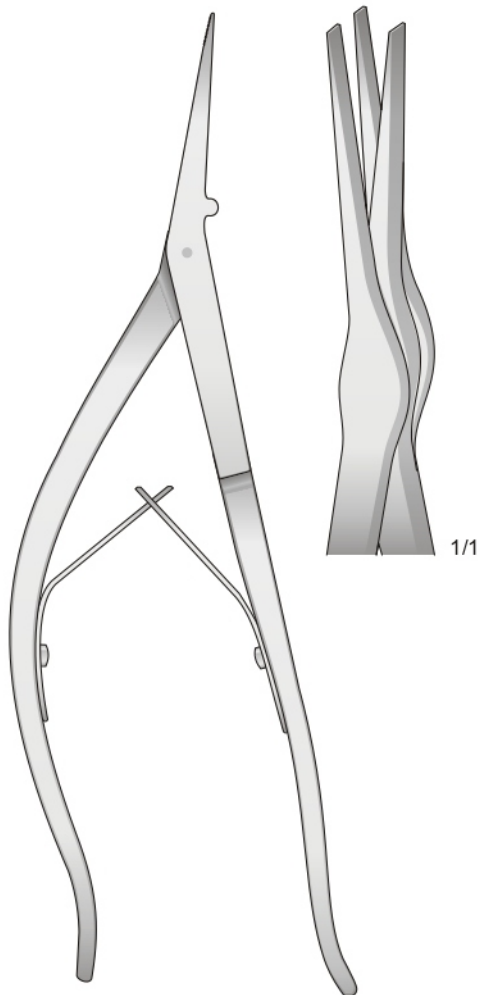
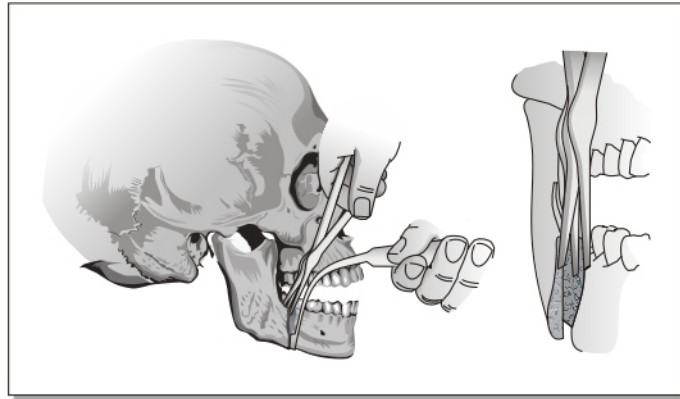

RAMUS
HS-8039
230 mm

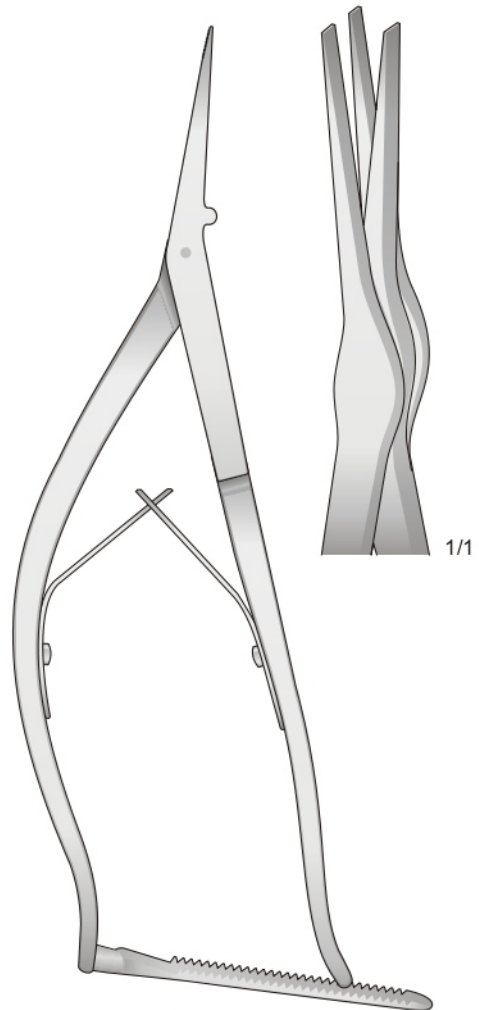

RAMUS
HS-8040
230 mm

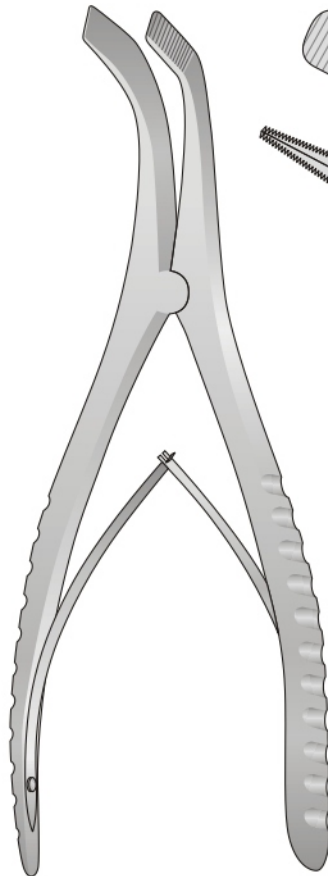
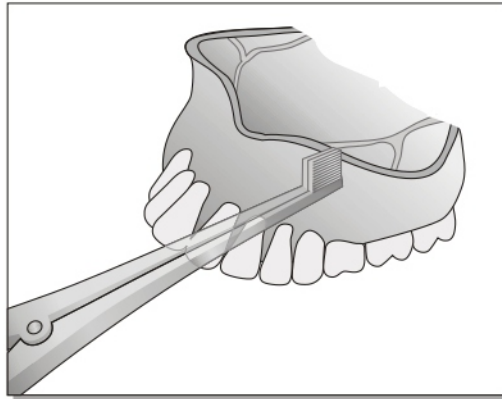

TESSIER
HS-8041
180 mm

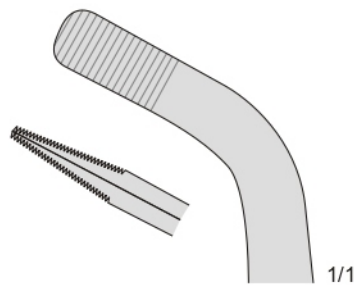

Maxillary expander

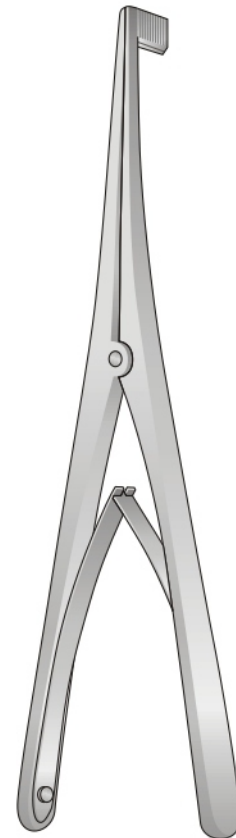

HS-8042
170 mm

Bone Holding Forceps

Lattanti
For juveniles
Für Jugendliche

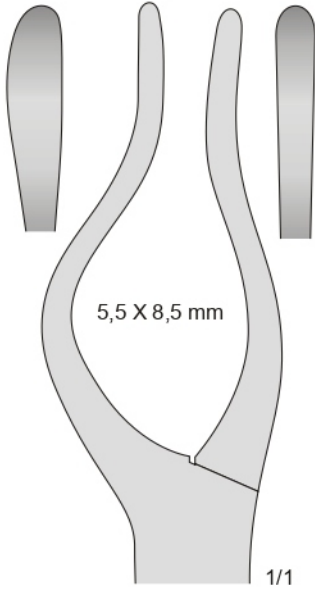

HS-8043-1
HS-8043-2
225 mm

Per bambini
For children
Für Kinder
Pour enfants
Para niños

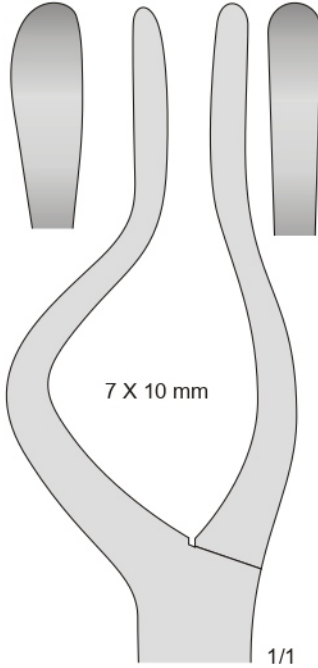

HS-8044-1
HS-8044-2
235 mm

Per adulti
For adults
Für Erwachsene
Pour adultes
Para adultos

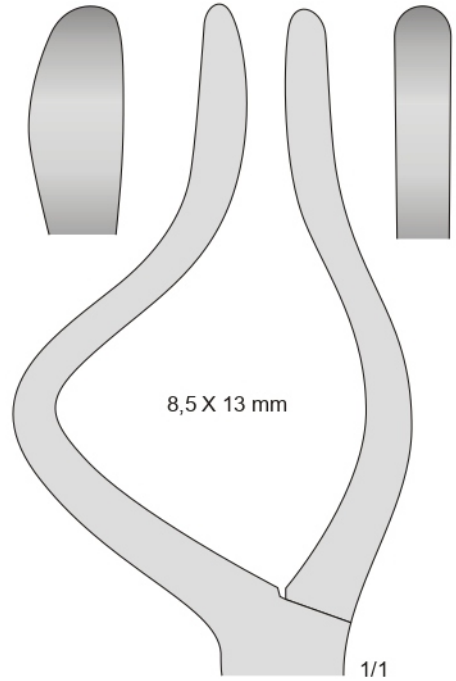

HS-8045-1
HS-8045-2
240 mm

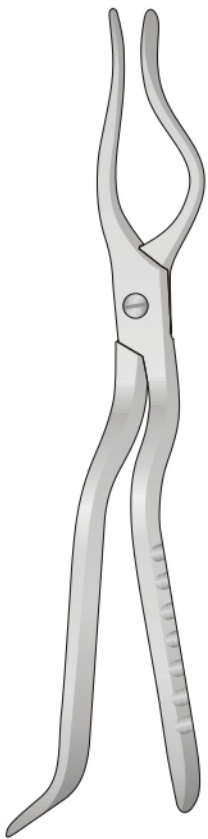

ROWE



ROWE



ROWE

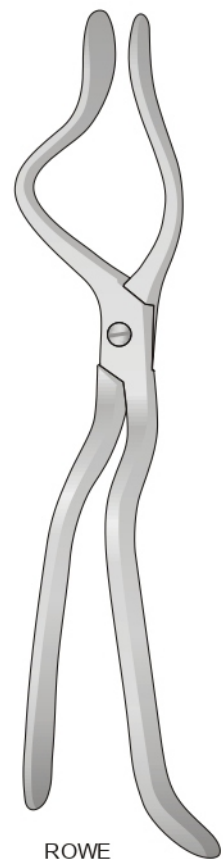

ROWE

Otology Instruments

Uncini

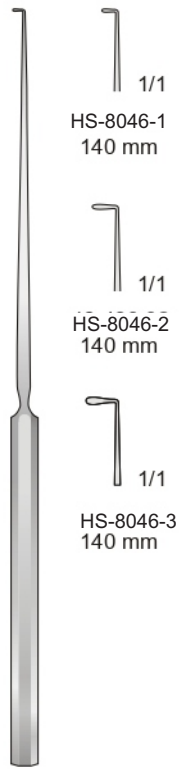

LUCAE
HS-8046
140 mm

Curette - Curettes - Löffel - Curettes - Curetas

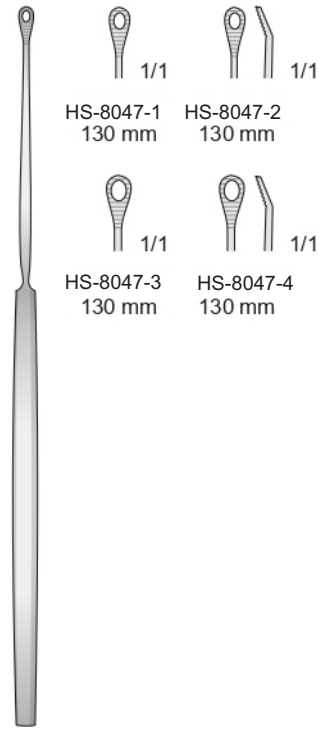

SHAPLEIGH
HS-8047
130 mm

Uncini

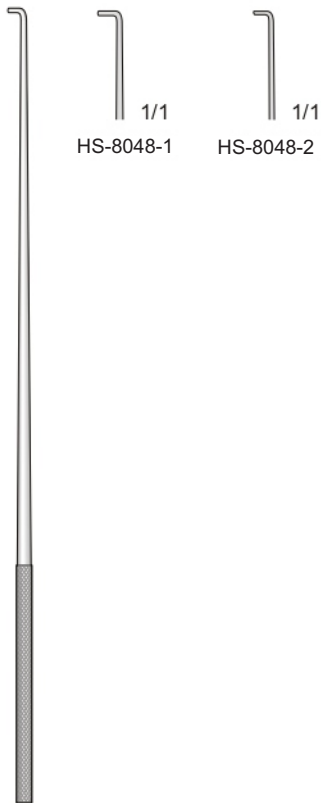

DAY
HS-8048
160 mm

Anse auricolari - Ear loobs anses - Ohrschlingen - Ansas auricolares

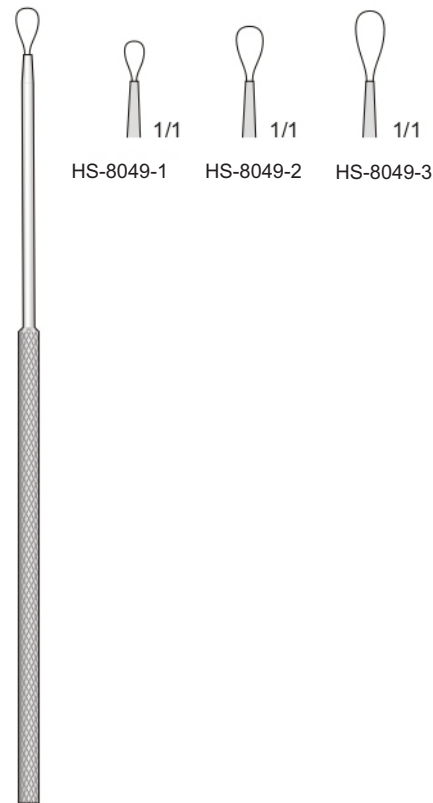

BILLEAU
HS-8049
160 mm

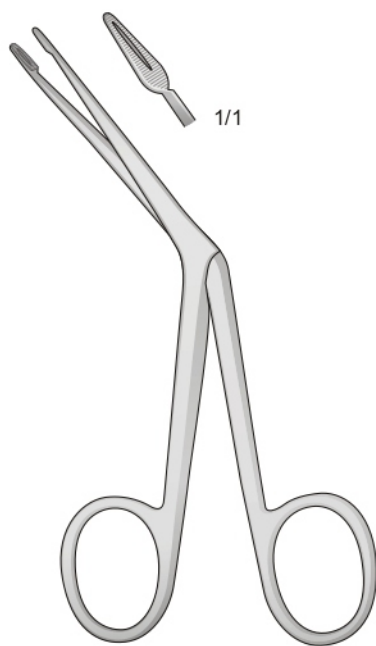
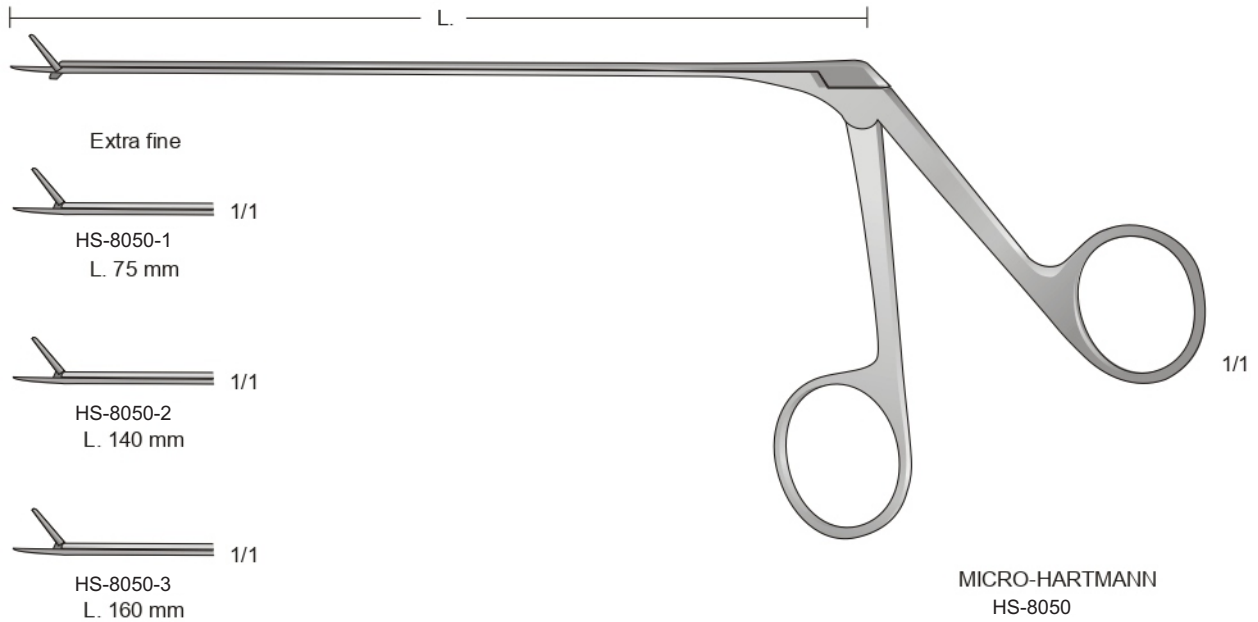

LITTAUER
HS-8051
120 mm

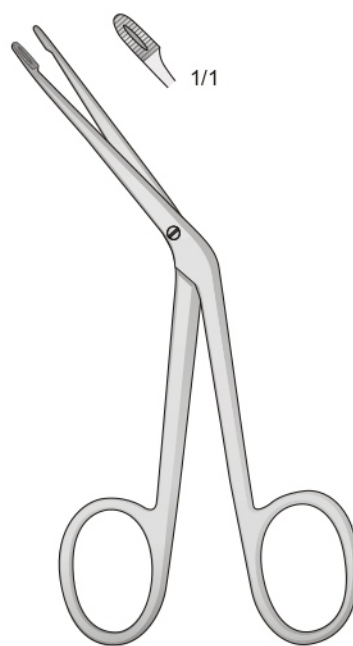

HARTMANN
HS-8052-1
120 mm

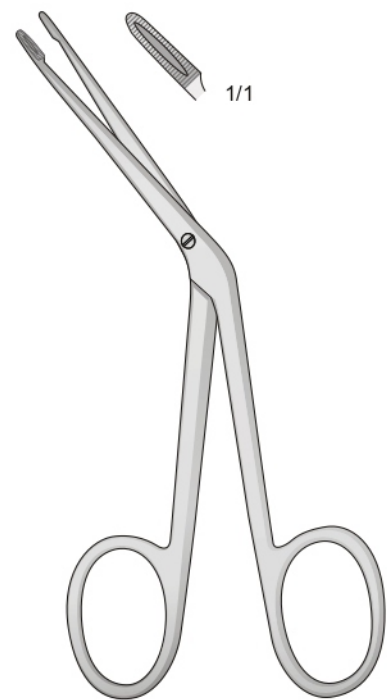

HARTMANN
HS-8052-2
140 mm



Ear Instruments

Pinze auricolari
Ear Forceps
Ohr-Polypenzangen
Pincès pour polypes auriculaires
Pinzas auricolàres



HS-8053-1
L.85 mm



HS-8053-2
L.85 mm

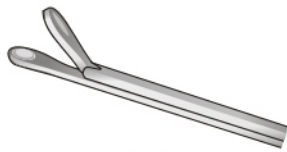

HS-8053-3
L.85 mm



HS-8053-4
L.85 mm



HS-8053-5
L.85 mm

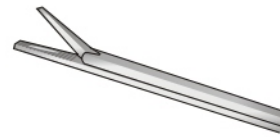

HS-8053-6
L.140 mm
13-550-07
L.165 mm

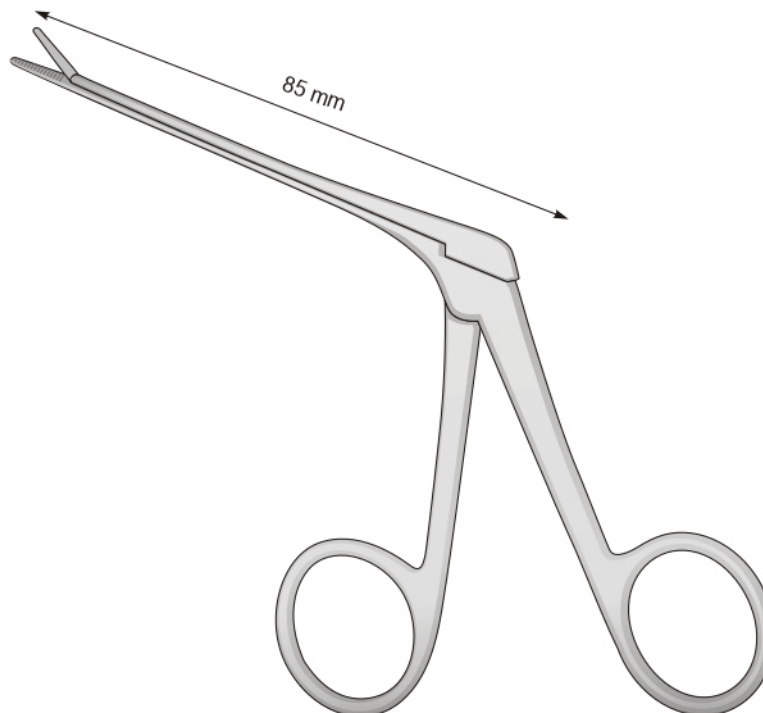

HS-8053
L. 85 mm

Micro forbice
 Micro scissor
 Mikro Scheren
 Micro ciseaux
 Micro tijeras

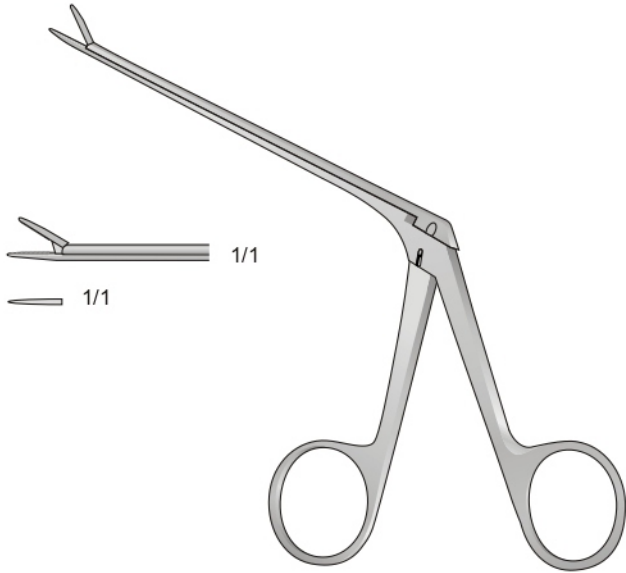

HS-8054
 80 mm

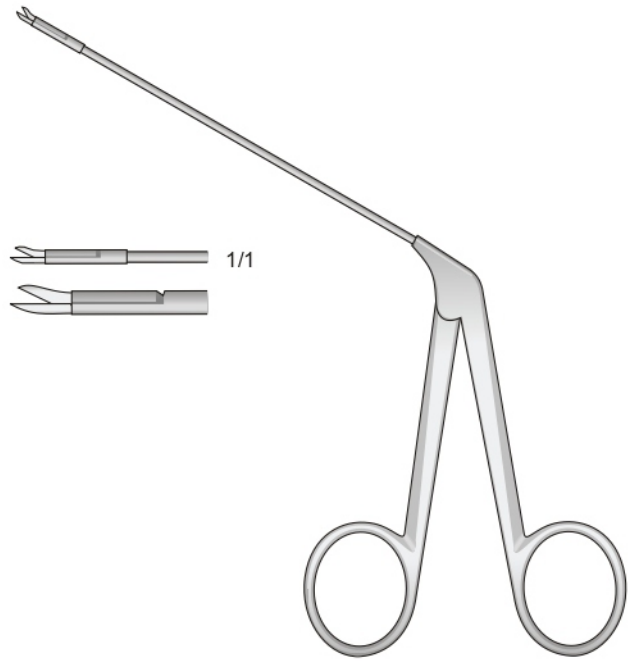

BELLUCCI
 HS-8055
 80 mm

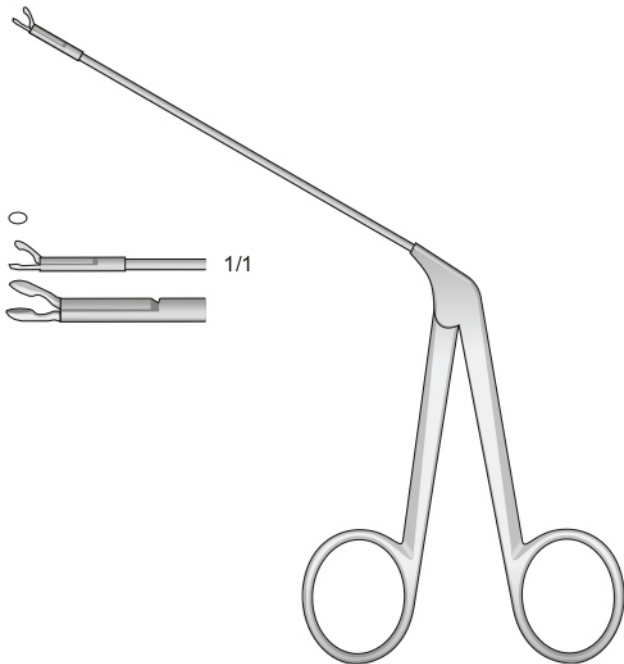

WULLSTEIN
 HS-8056
 80 mm

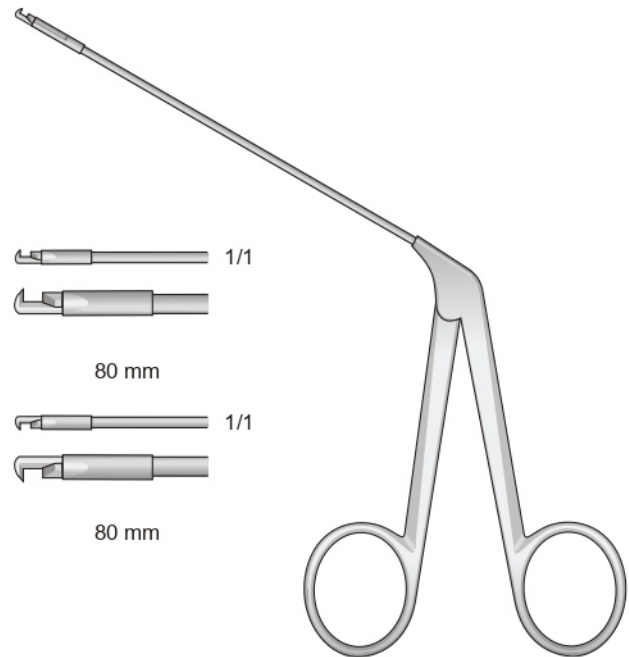

DIETER
 HS-8057
 80 mm

Mikro-Schere

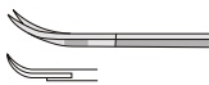

FAHLBUSCH
 HS-8058-1
 165 mm

FAHLBUSCH
 HS-8058-2
 230 mm

Scharfe Zange

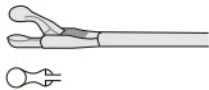

NICOLA
 HS-8058-3
 165 mm

NICOLA
 HS-8058-4
 230 mm

Mikro-Schere

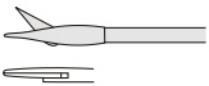

NICOLA
 HS-8058-5
 165 mm

NICOLA
 HS-8058-6
 230 mm

Faßzange

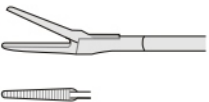

YASARGIL-NICOLA
 HS-8058-7
 165 mm

YASARGIL-NICOLA
 HS-8058-8
 230 mm

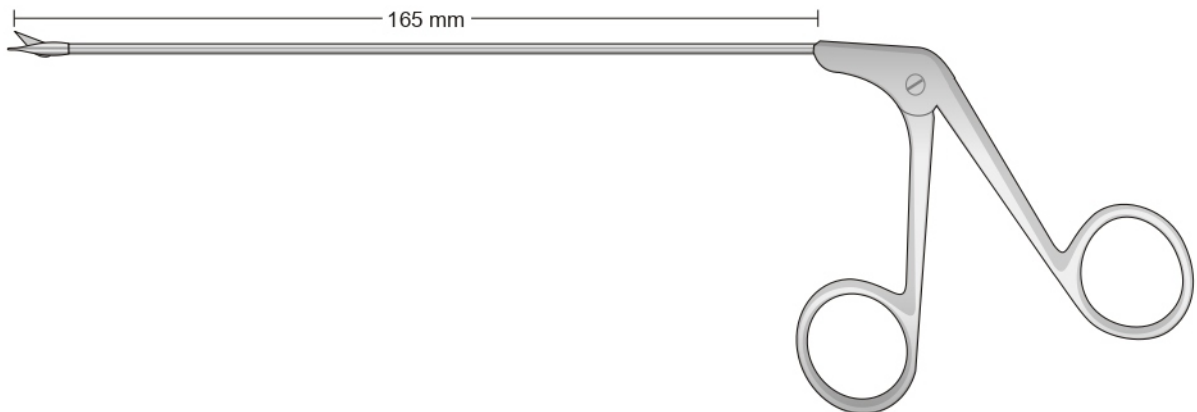

NICOLA
 HS-8058
 165 mm

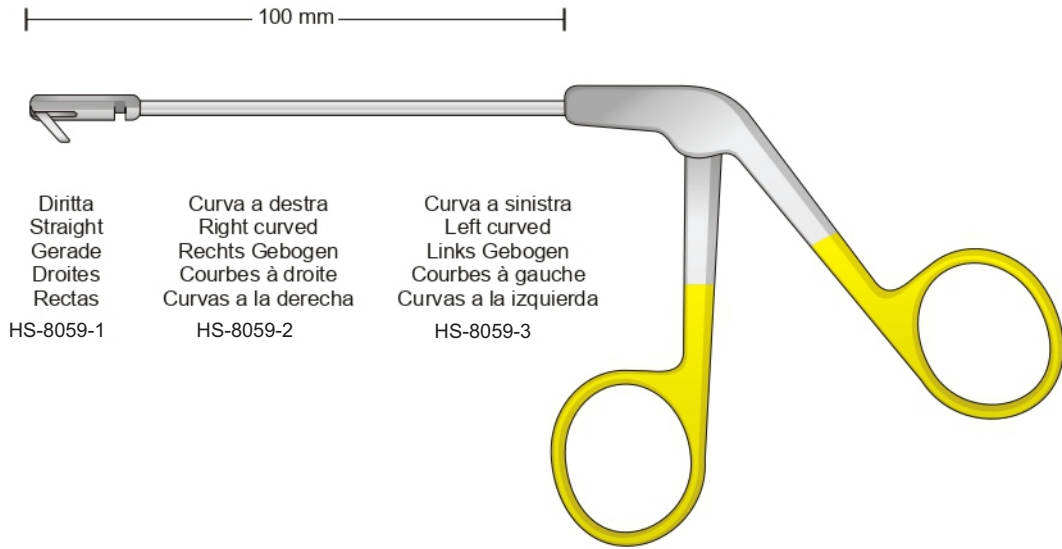

Diritta
Straight
Gerade
Droites
Rectas
HS-8059-1

Curva a destra
Right curved
Rechts Gebogen
Courbes à droite
Curvas a la derecha
HS-8059-2

Curva a sinistra
Left curved
Links Gebogen
Courbes à gauche
Curvas a la izquierda
HS-8059-3

STAMBERGER
HS-8059

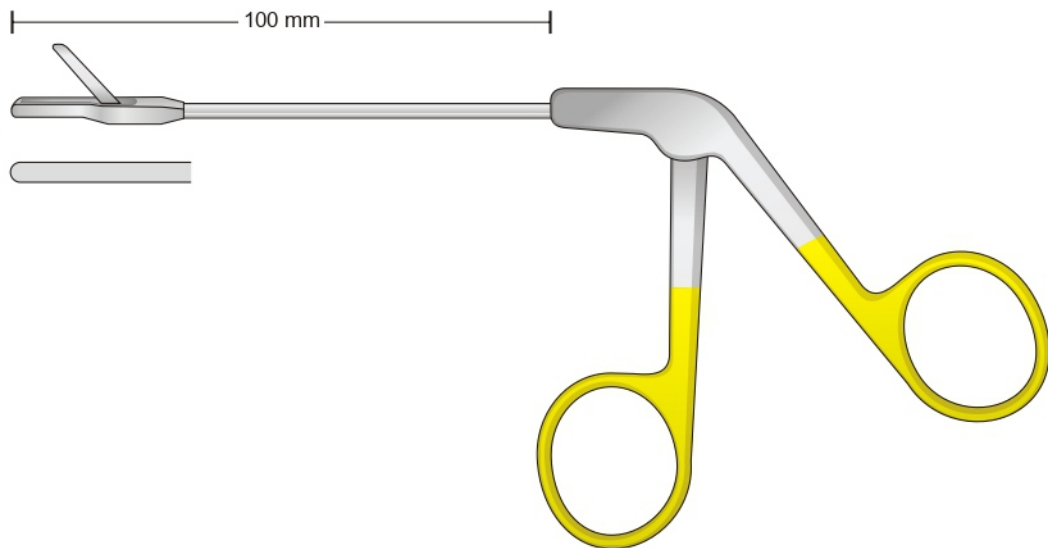

STRUYCKEN
HS-8060



130 mm

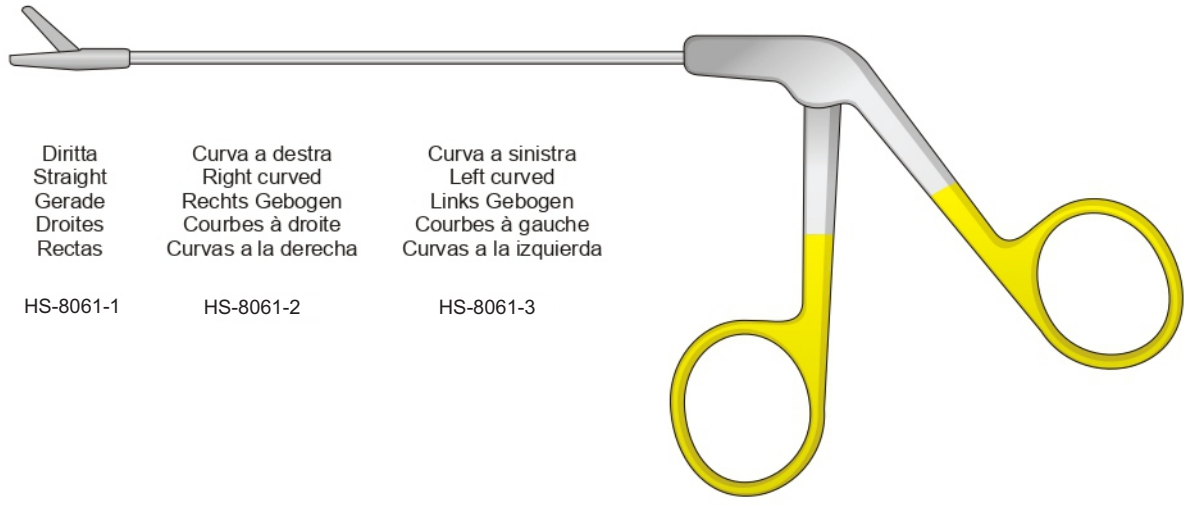

Diritta Straight Gerade Droites Rectas	Curva a destra Right curved Rechts Gebogen Courbes à droite Curvas a la derecha	Curva a sinistra Left curved Links Gebogen Courbes à gauche Curvas a la izquierda
HS-8061-1	HS-8061-2	HS-8061-3

HS-8061

140 mm

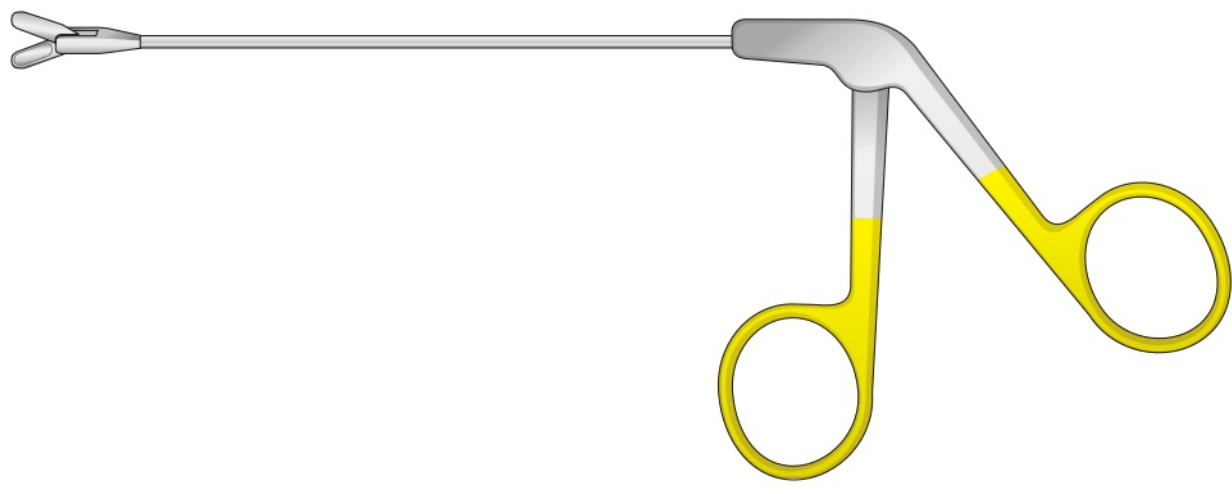

HS-8062

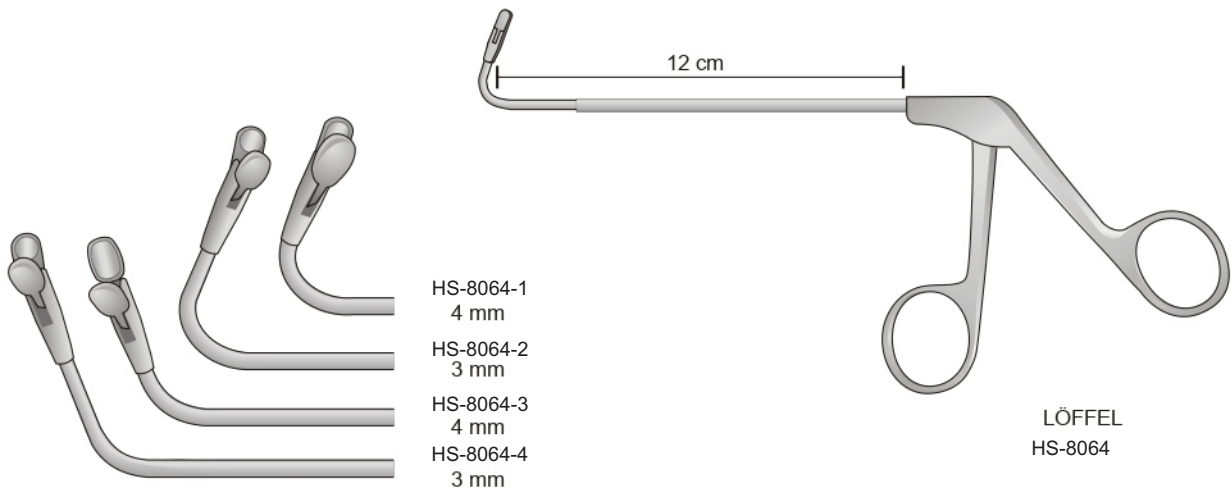
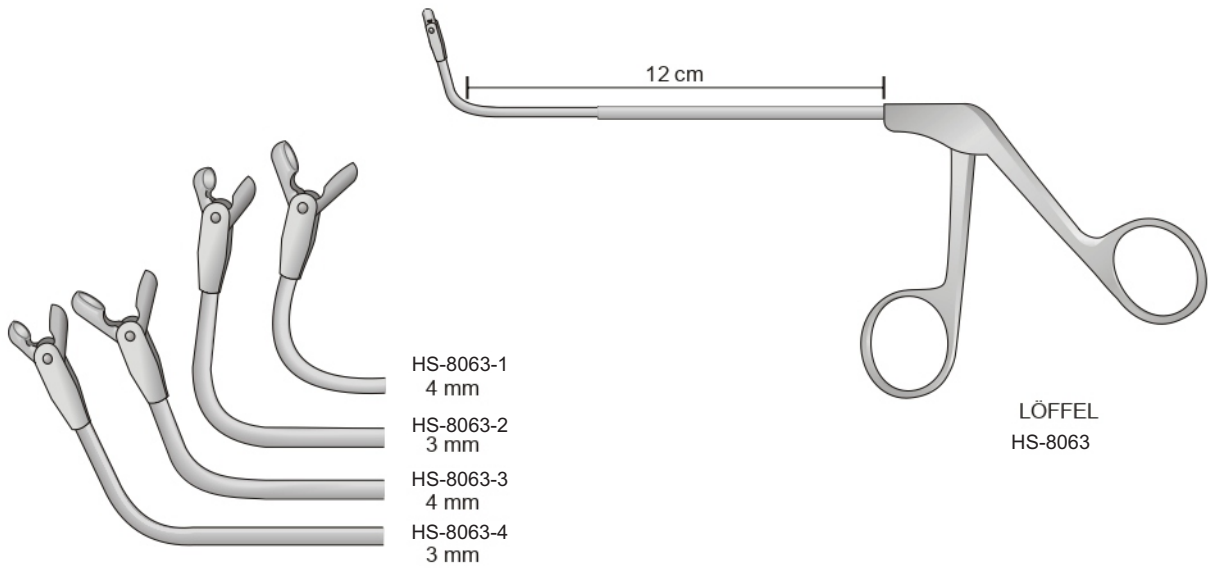

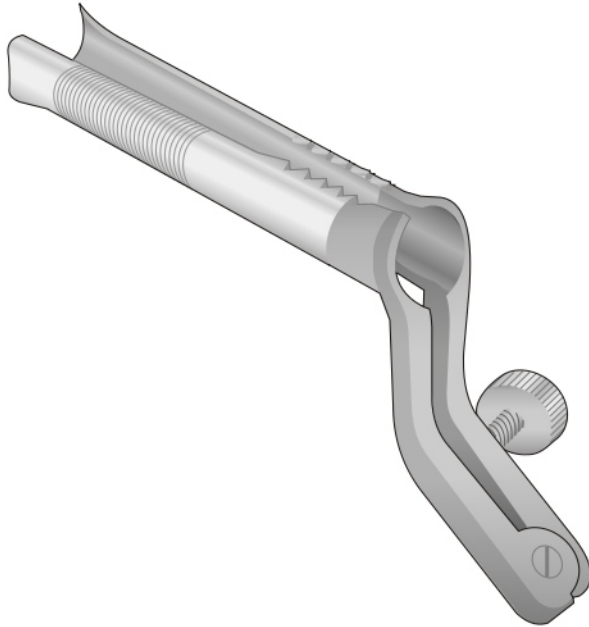

PAPAVERO-CASPAR
HS-8065-1 80 x 11 mm
HS-8065-2 90 x 13 mm
HS-8065-3 100 x 15 mm



PAPAVERO-HARTMANN
HS-8066
140 mm

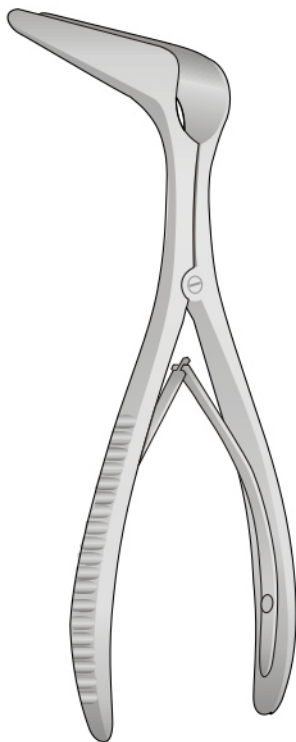

COTTLE
HS-8067
150 mm

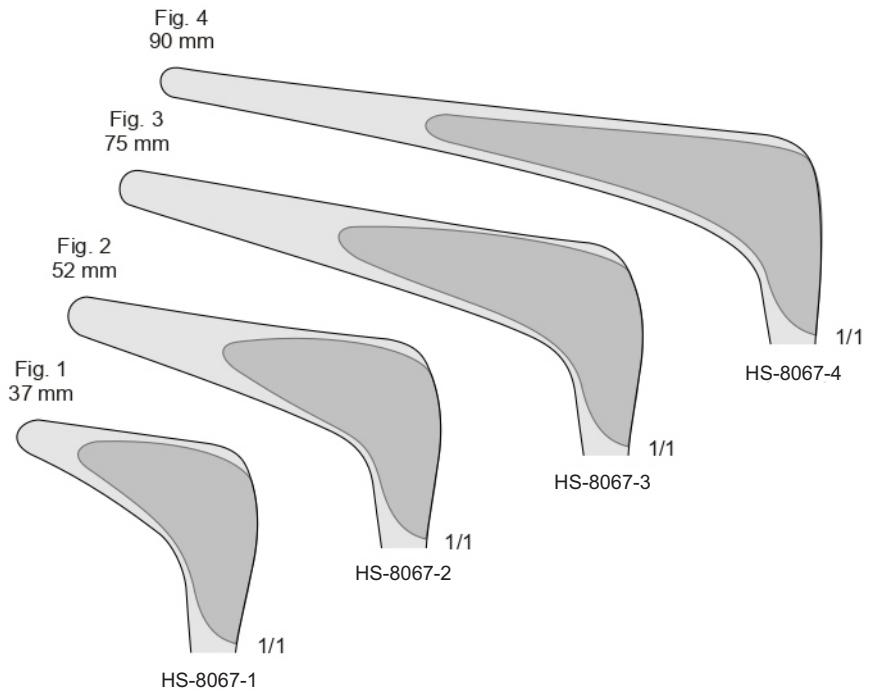

Speculum nasali
 Nasal specula
 Nasen Spekula
 Spéculums nasaux
 Espéculos nasales

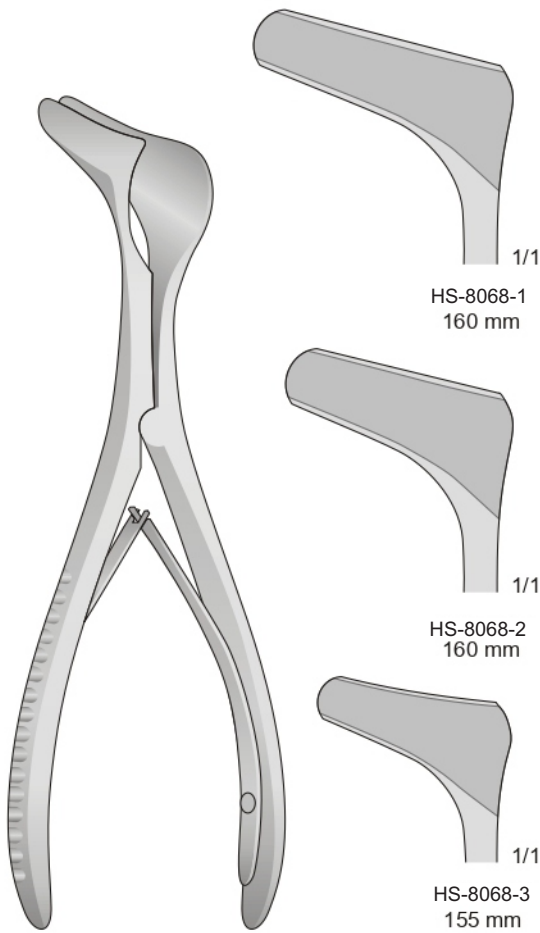

HARTMANN
 HS-8068

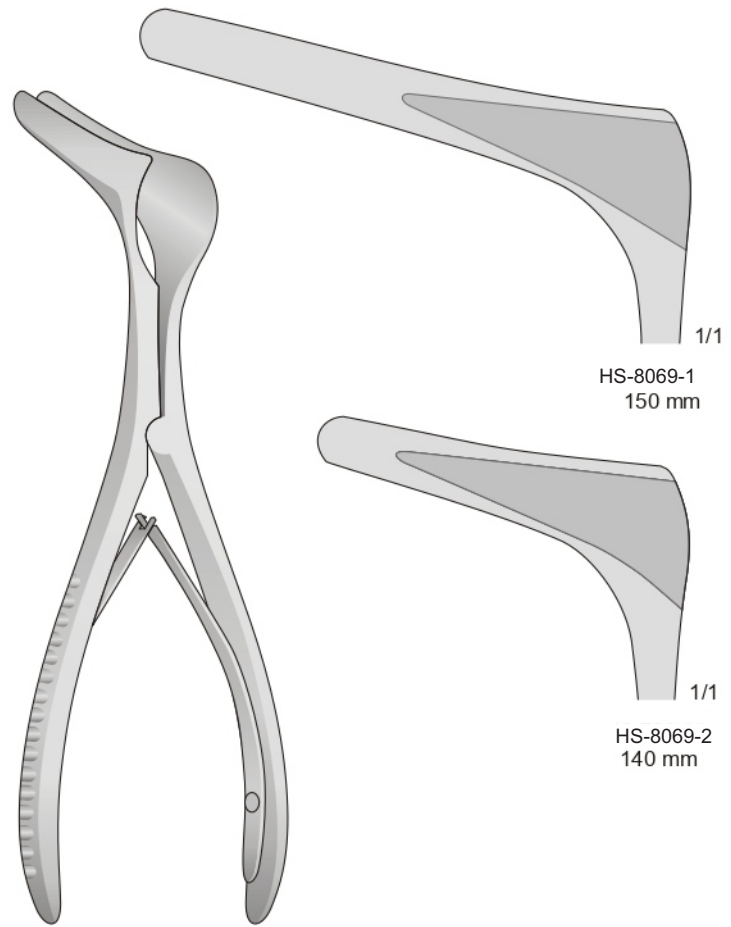

KILLIAN
 HS-8069

Speculum nasali
Nasal specula
Nasen Spekula
Spéculums nasaux
Espéculos nasales

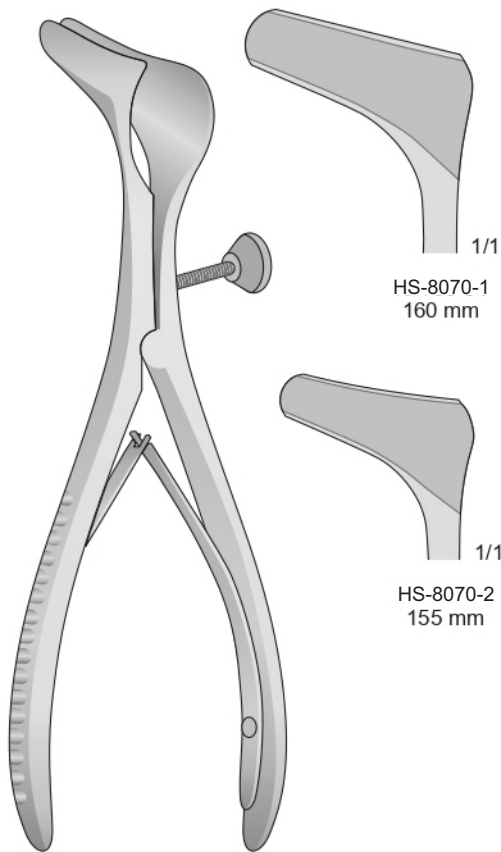

HARTMANN
HS-8070

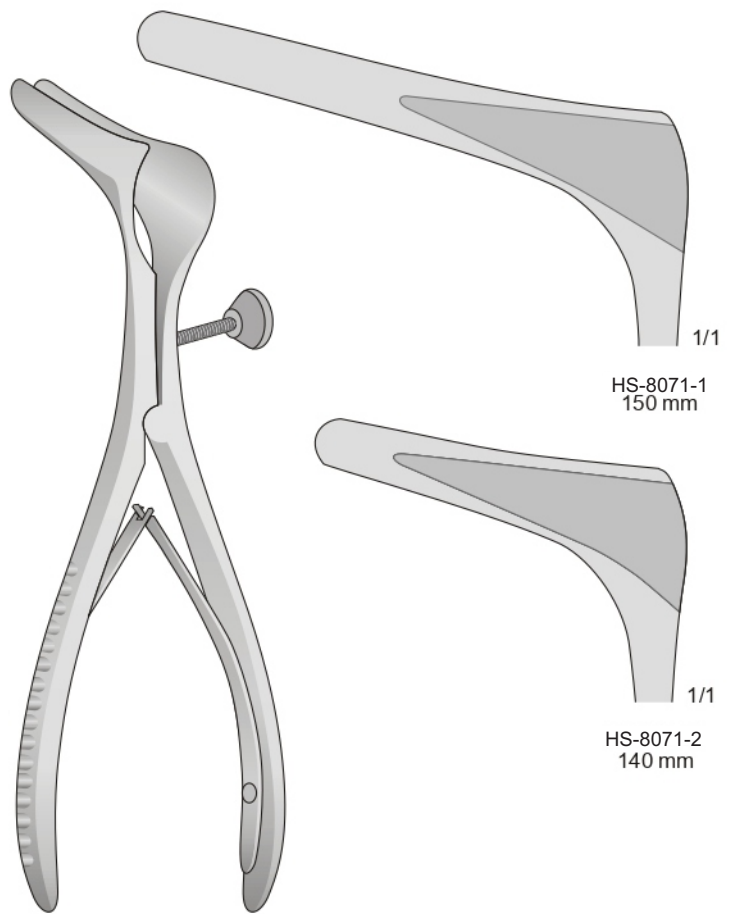

KILLIAN
HS-8071



Pinza serranodi
Ear polypus snares
Polypenschnürer
Serre noeuds
Polipötomos

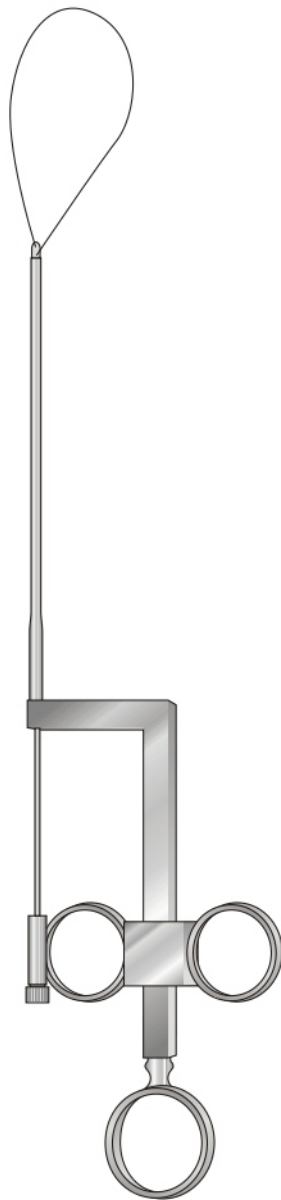

WILDE
HS-8072
240 mm

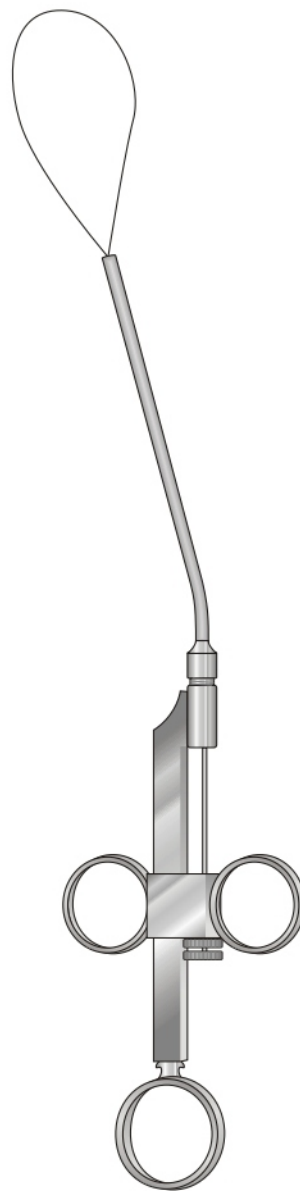

KRAUSE
HS-8073
260 mm

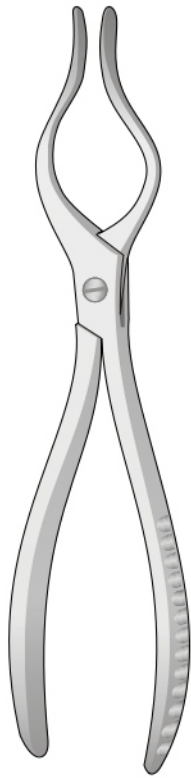

COTTLE-WALSHAM
HS-8074
230 mm

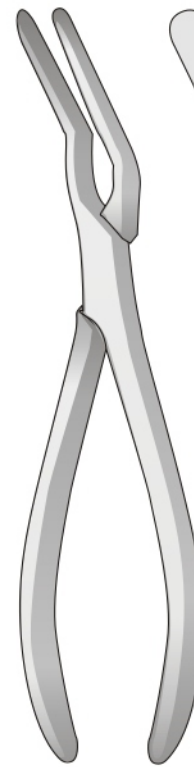
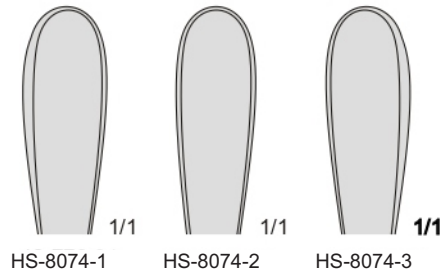

ASH
HS-8075
230 mm

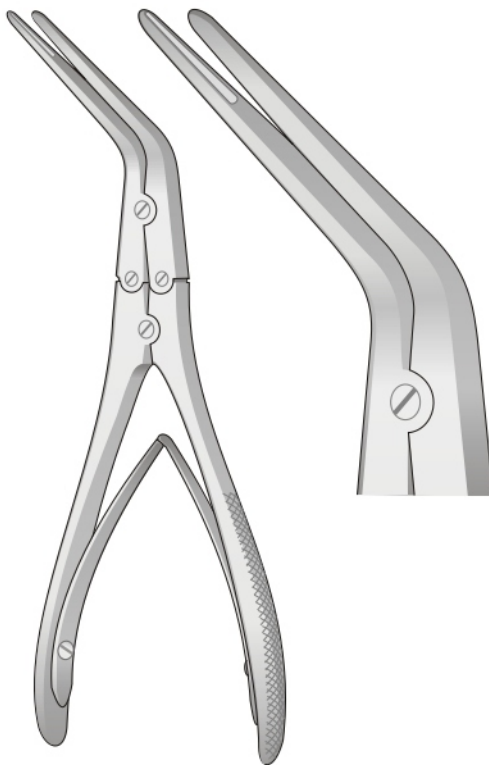
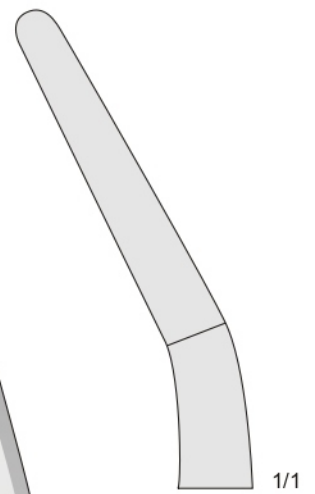

KRESSNER
HS-8076
200 mm

1/1

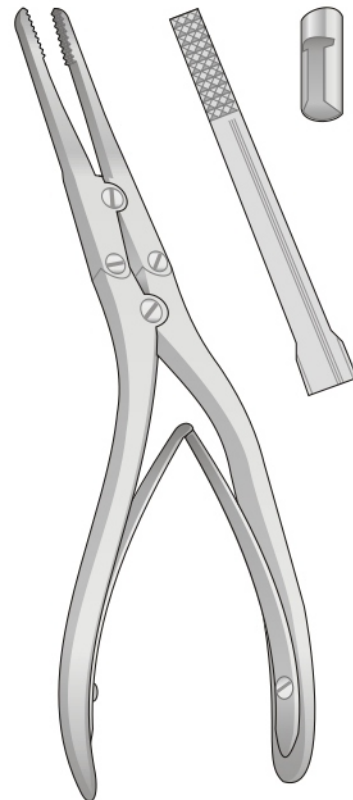

RUBIN
HS-8077
210 mm

1/1



Strumento per rotture e asportazione frammenti ossei e cartilagine
Bone crusher
Knochen-Knorpelquetsche
Instrument à écraser le cartilage
Instrumento para magullar carilagos

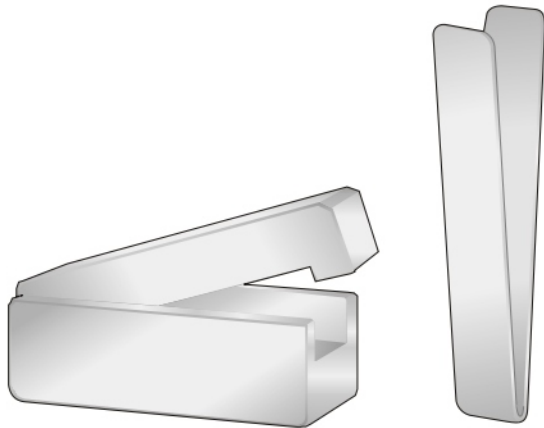

COTTLE
HS-8078

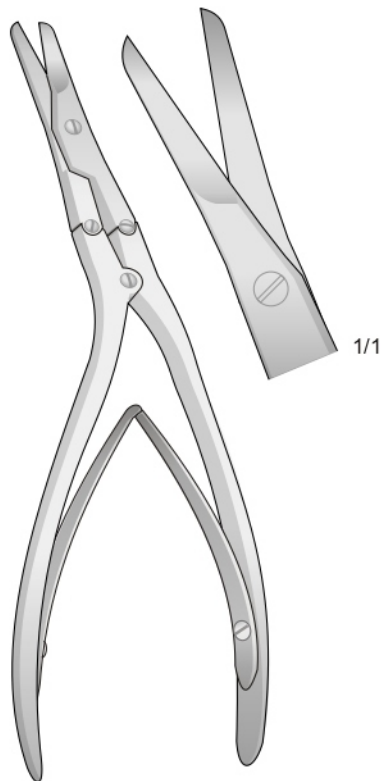

CAPLAN
HS-8079
200 mm

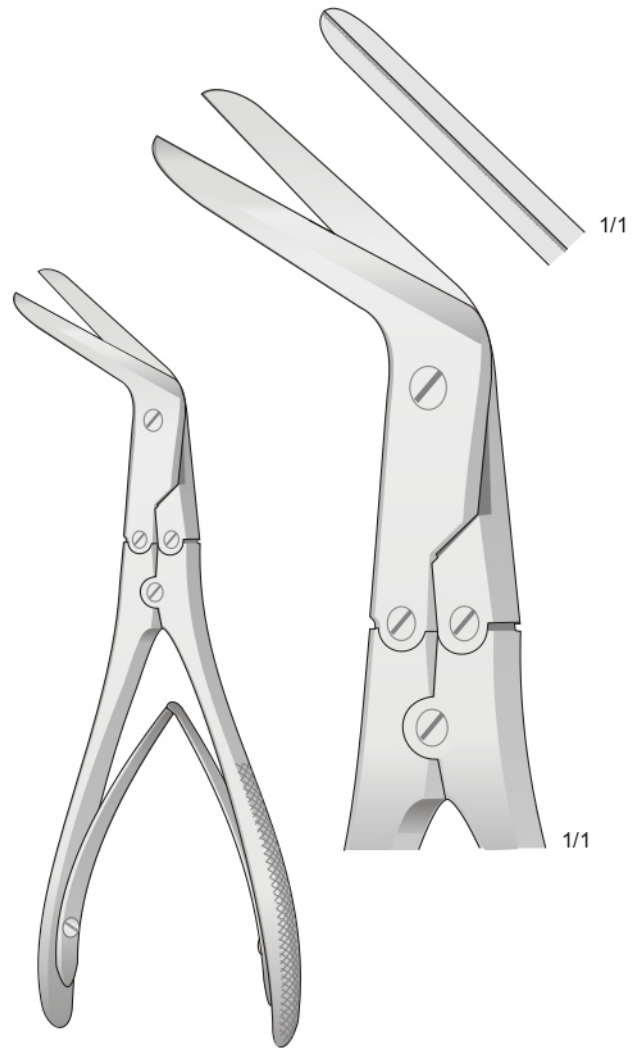

KILLIAN
HS-8080
210 mm

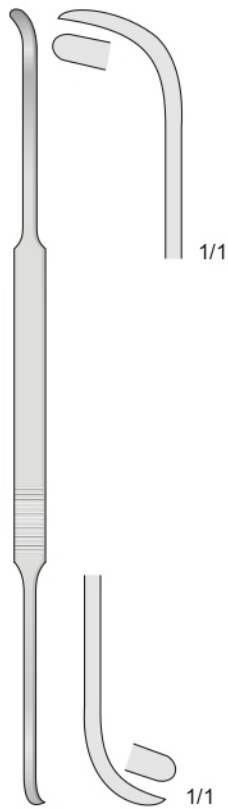

COTTLE
HS-8081
230 mm

Acuto/Smusso - Sharp/Blunt
Spitz/Stumpf - Pointu/Mousse
Agudas/Romas

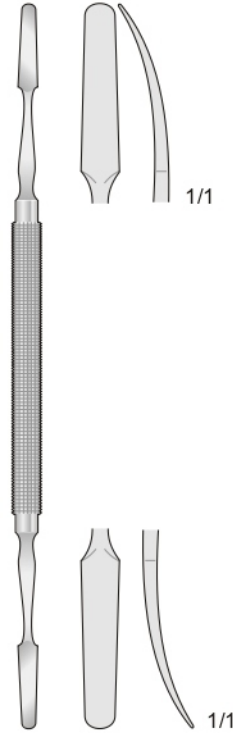

KILIAN
HS-8082
180 mm

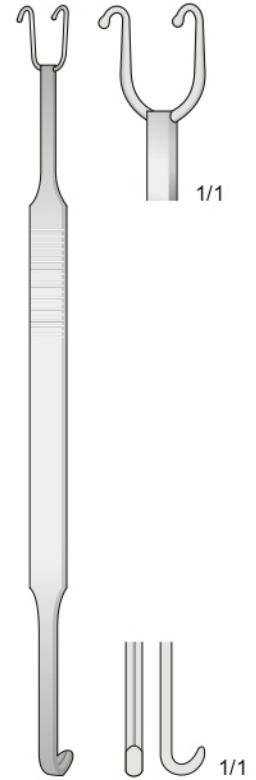

COTTLE-NEIVERT
HS-8083
200 mm

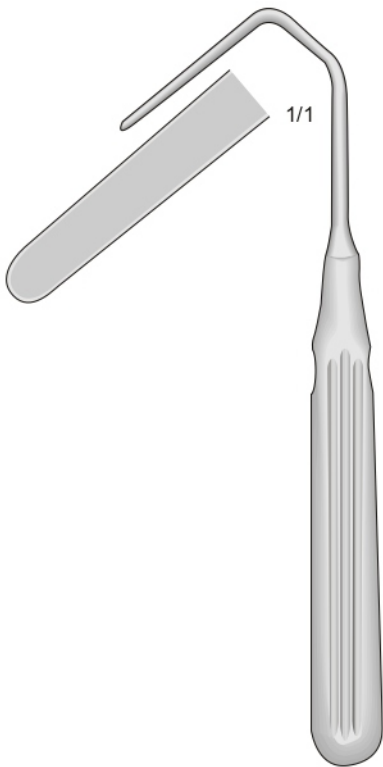

AUFRICHT
HS-8084
175 mm

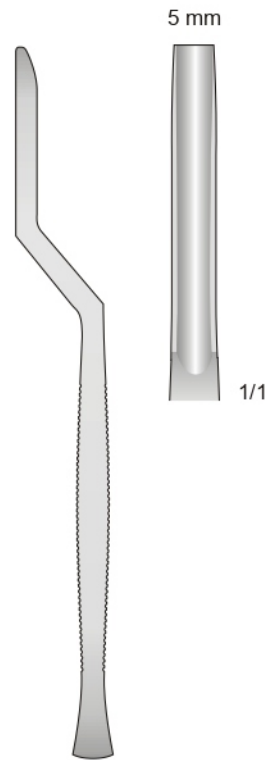

KILIAN
HS-8085
160 mm

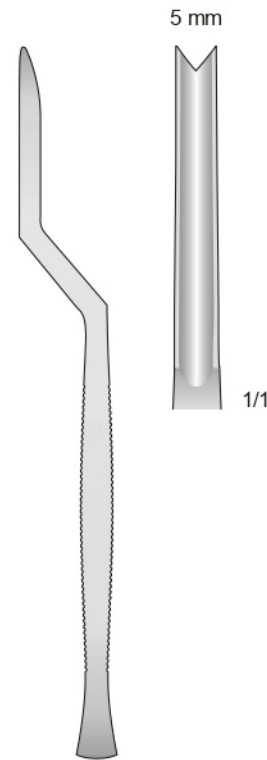

KILIAN-KLAUS
HS-8086
160 mm

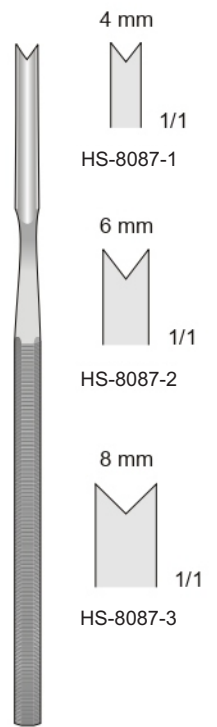

BALLENGER
HS-8087
150 mm



Rhinology

Diritta
Straight
Gerade
Droites
Rectas



SILVER
HS-8088-1
180 mm

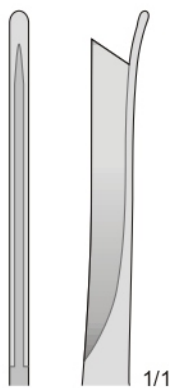

1/1

Curva, sinistra
Curved, left
Gebogen, links
Courbes à gauche
Curvas a la izquierda



SILVER
HS-8088-2
180 mm

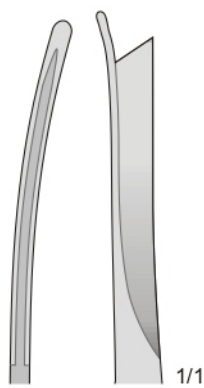

1/1

Curva, destra
Curved, right
Gebogen, rechts
Courbes à droite
Curvas a la derecha



SILVER
HS-8088-3
180 mm

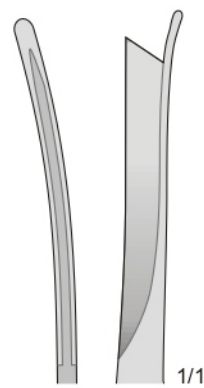

1/1

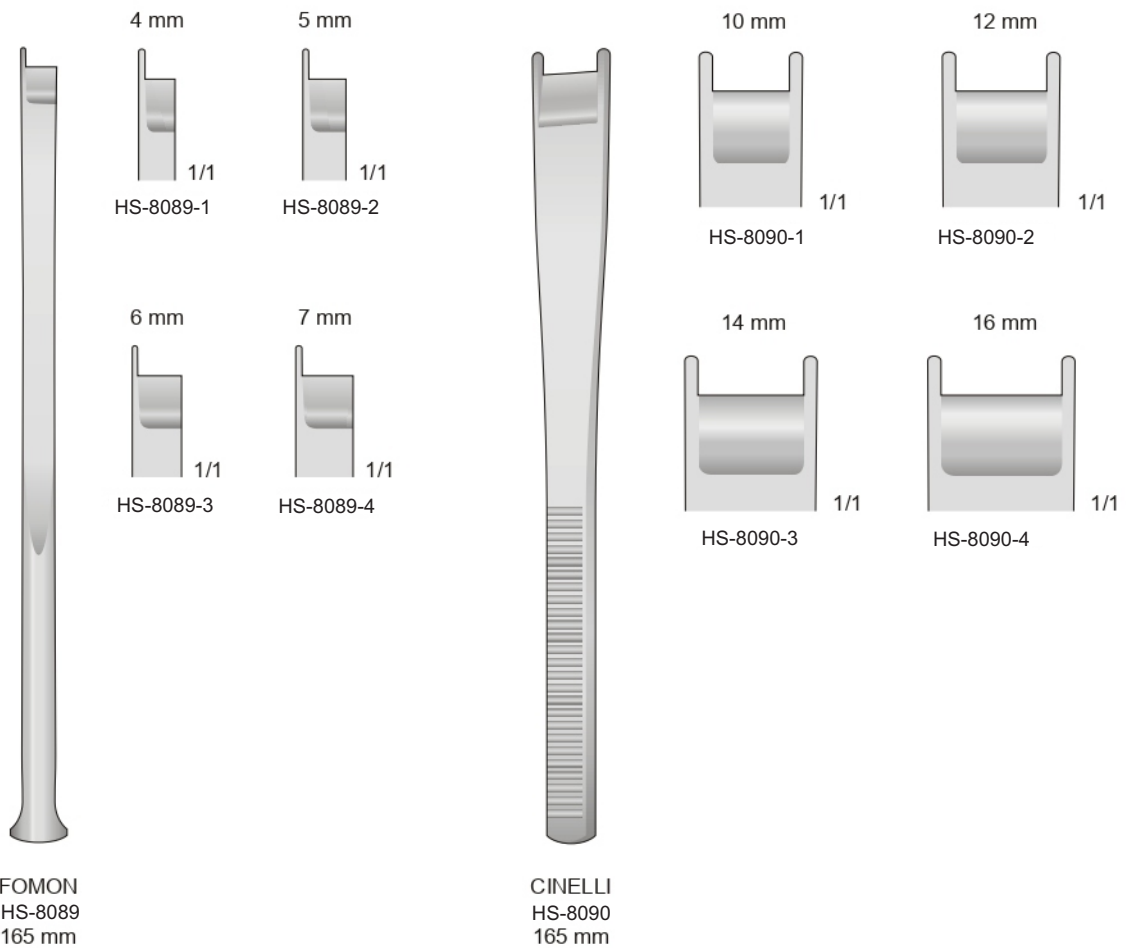

Nasal septum
Osteotomes, graduated

U form

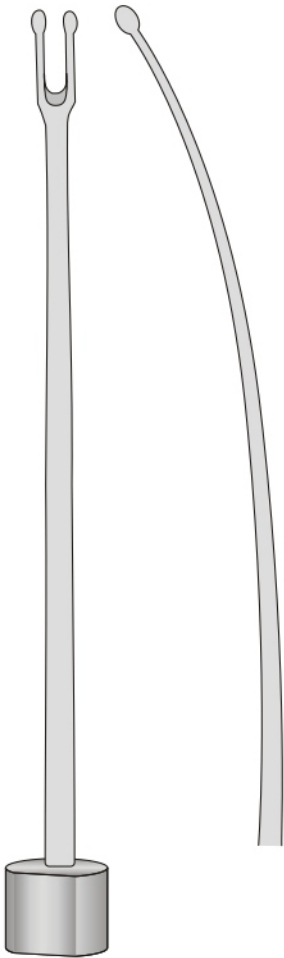

OBWEGESER
HS-8091-1
185 mm

V form

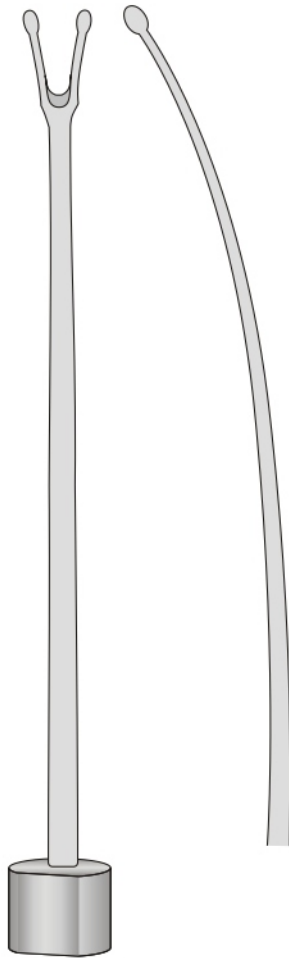

OBWEGESER
HS-8091-2
185mm

4 mm

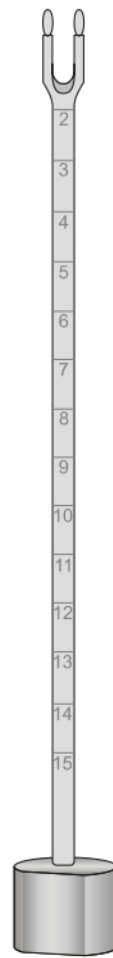

OBWEGESER
HS-8091-3
185 mm

6 mm

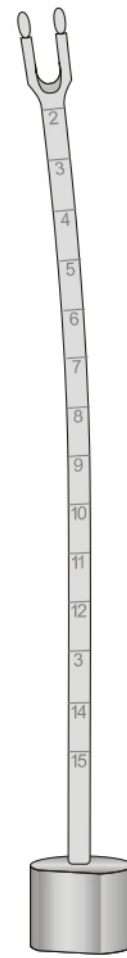

OBWEGESER
HS-8091-4
185 mm

8 mm

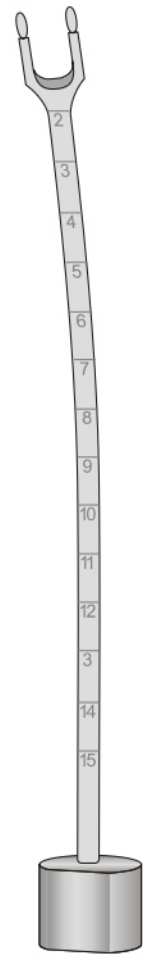

OBWEGESER
HS-8091-5
185 mm

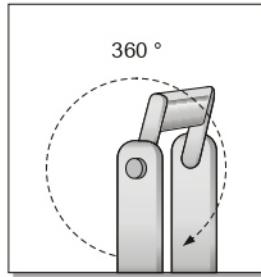

BALLENGER
 HS-8092
 200 mm



HS-8092-1
 3 mm



HS-8092-2
 4 mm



HS-8092-3
 5 mm



BALLENGER
 HS-8093
 200 mm

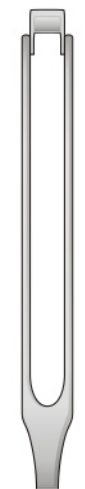

HS-8093-1
 3 mm



HS-8093-2
 4 mm

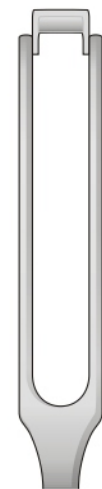

HS-8093-3
 5 mm

Fig. 67

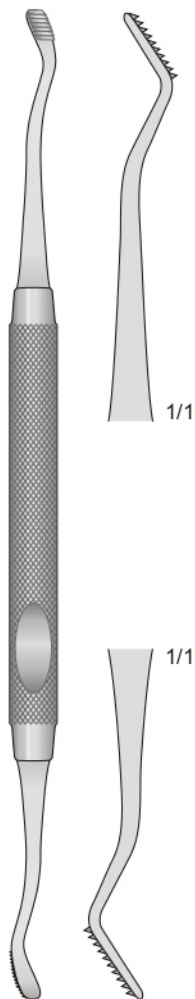

HOWARD
 HS-8094
 180 mm

Fig. 45

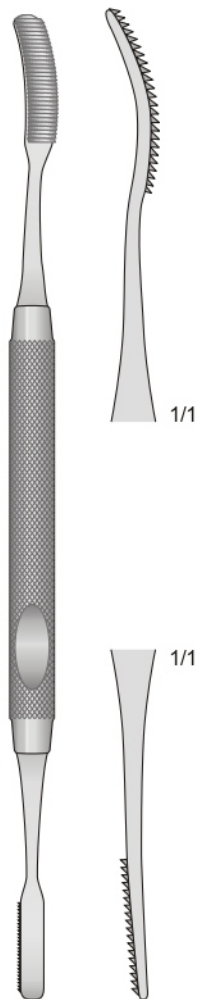

MILLER
 HS-8095-1
 185 mm

Fig. 52

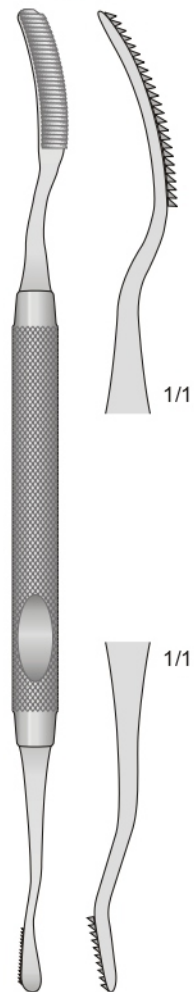

MILLER
 HS-8095-2
 180 mm

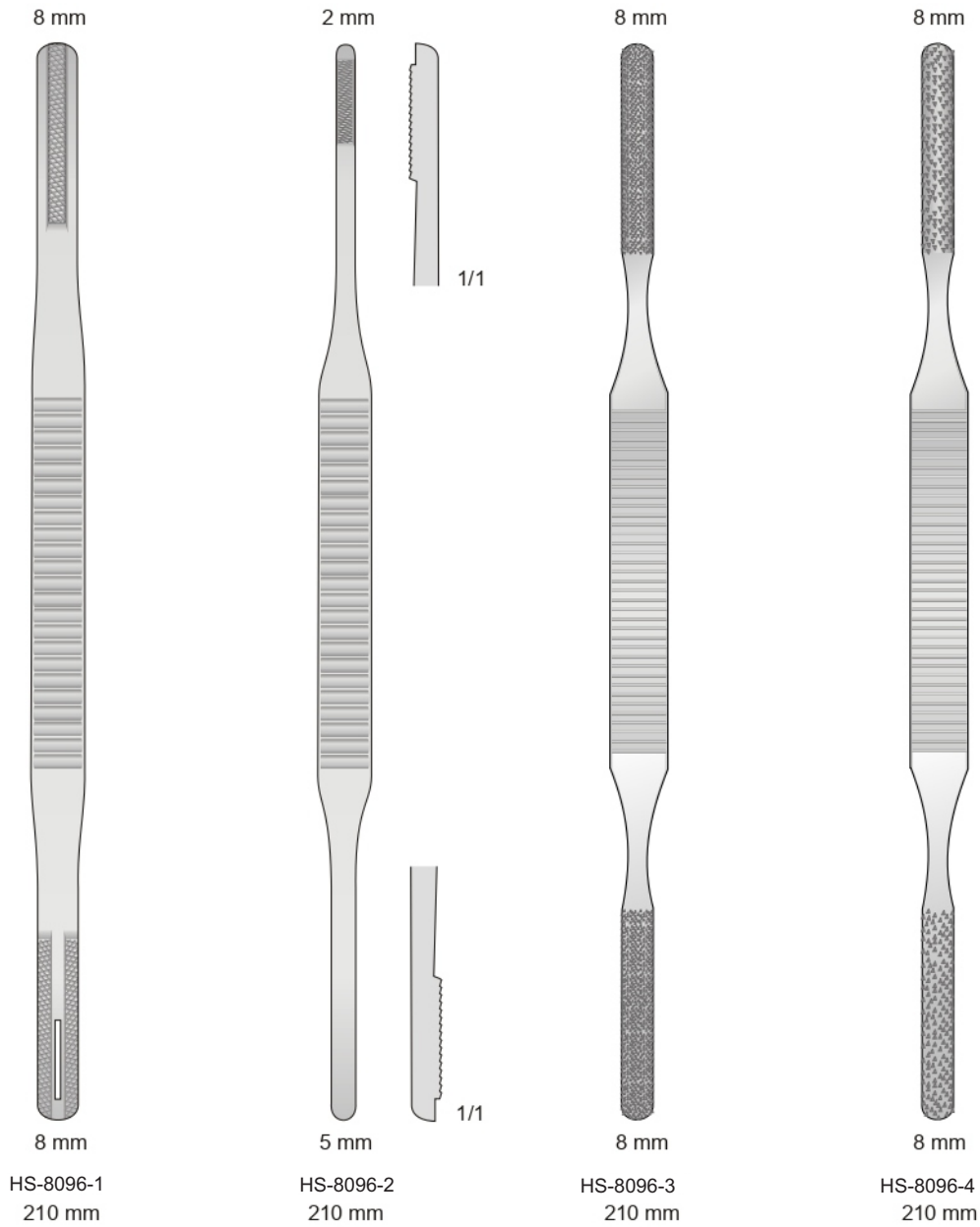

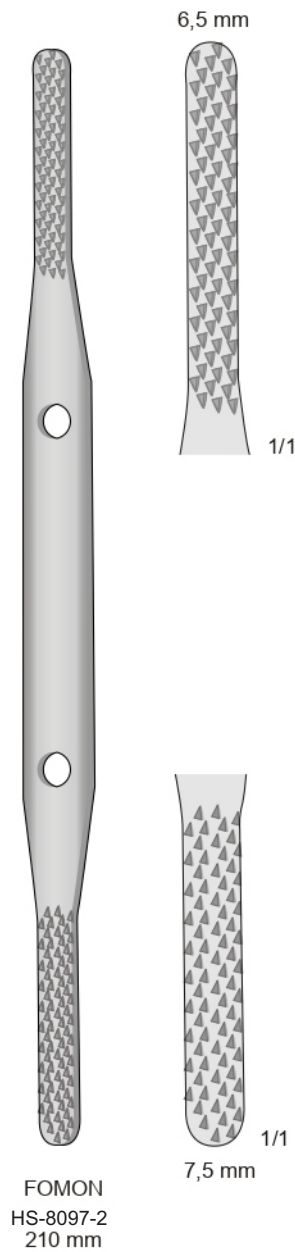
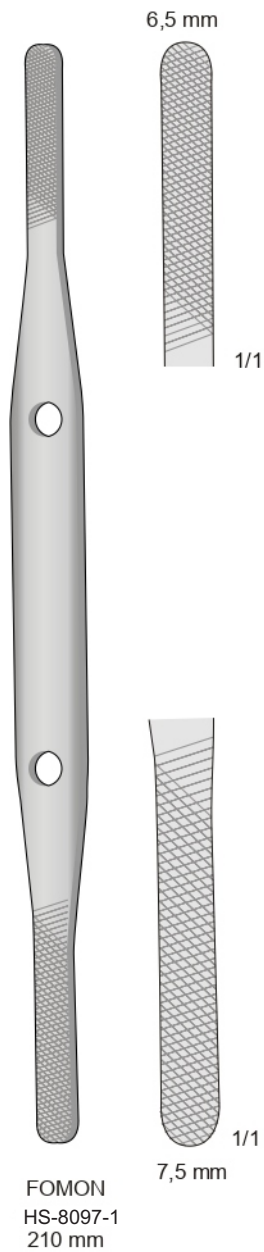

Bisturi per mucosa
Mucous knife
Mukosamesser



FREER
HS-8098
165 mm

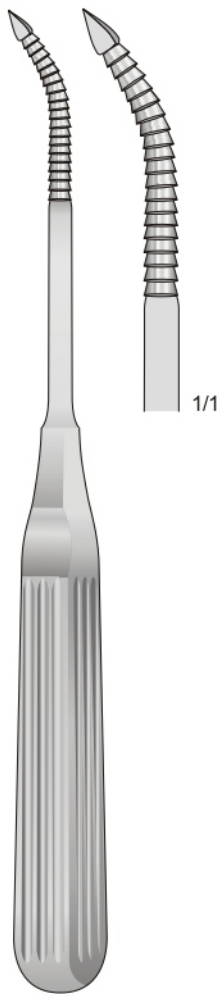

LEWIS
HS-8099-1
180 mm

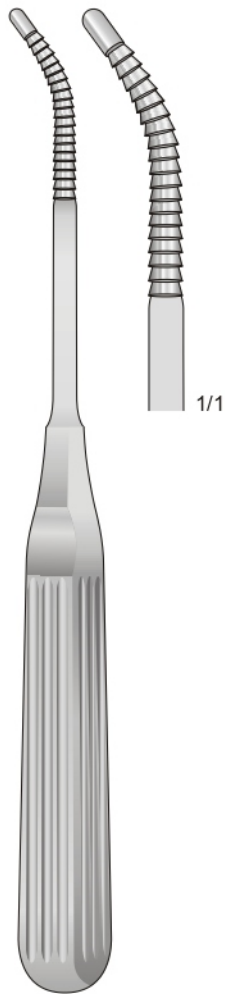

LEWIS
HS-8099-2
180 mm



JOSEPH
HS-8100
190 mm

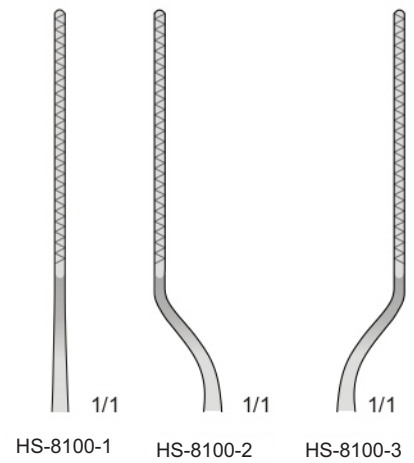

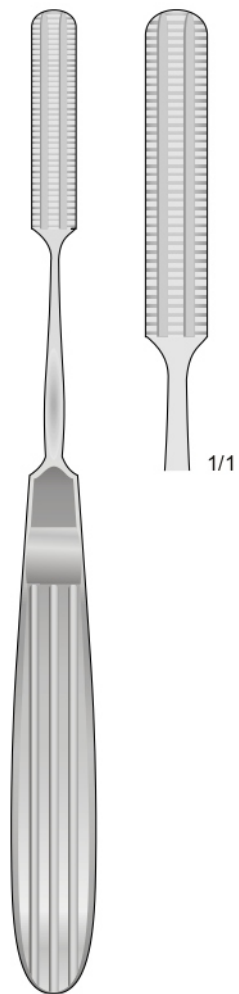

MALTZ
HS-8101
180 mm

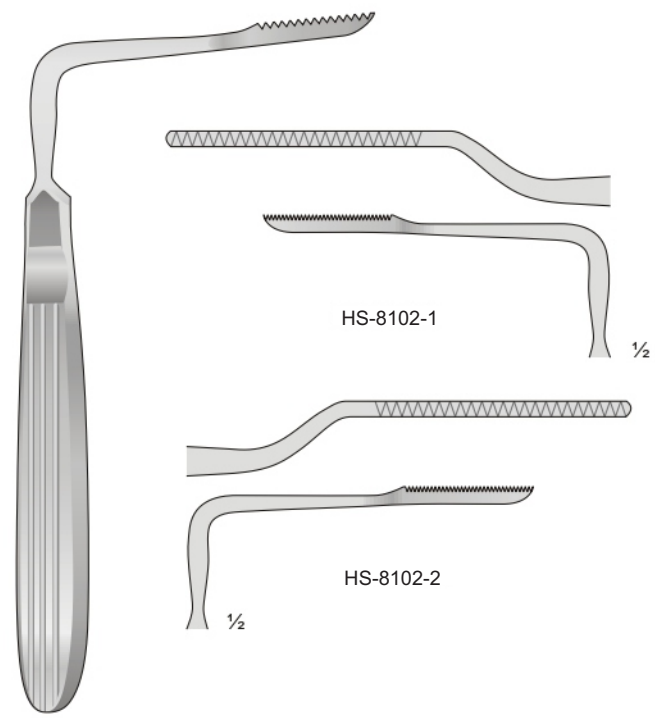

JOSEPH
HS-8102
135 mm



Uncino per arco zigomato
Zigoma hook
Haken-Jochbogenahle

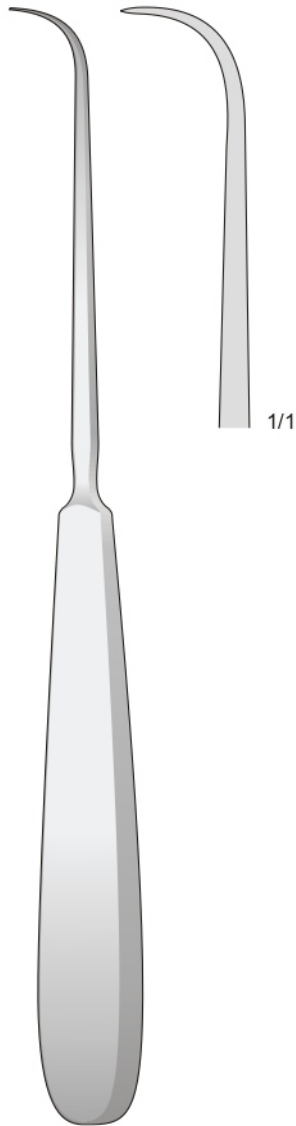

HS-8103
200 mm

Curette taglienti
Scharfe Küretten
Curettes Tranchantes

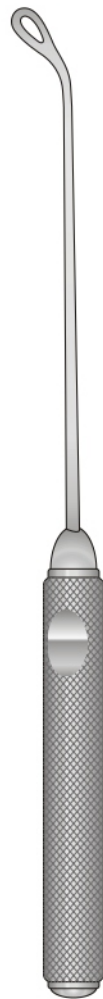

COAKLEY
HS-8104
170 mm

Fig. 1



HS-8104-1

Fig. 2



HS-8104-2

Fig. 3



HS-8104-3

Fig. 4



HS-8104-4

Fig. 5



HS-8104-5

Fig. 6



HS-8104-6

Adenotomi - Adenotomie - Adenoidectomy
Adénoïdes - Adenoides

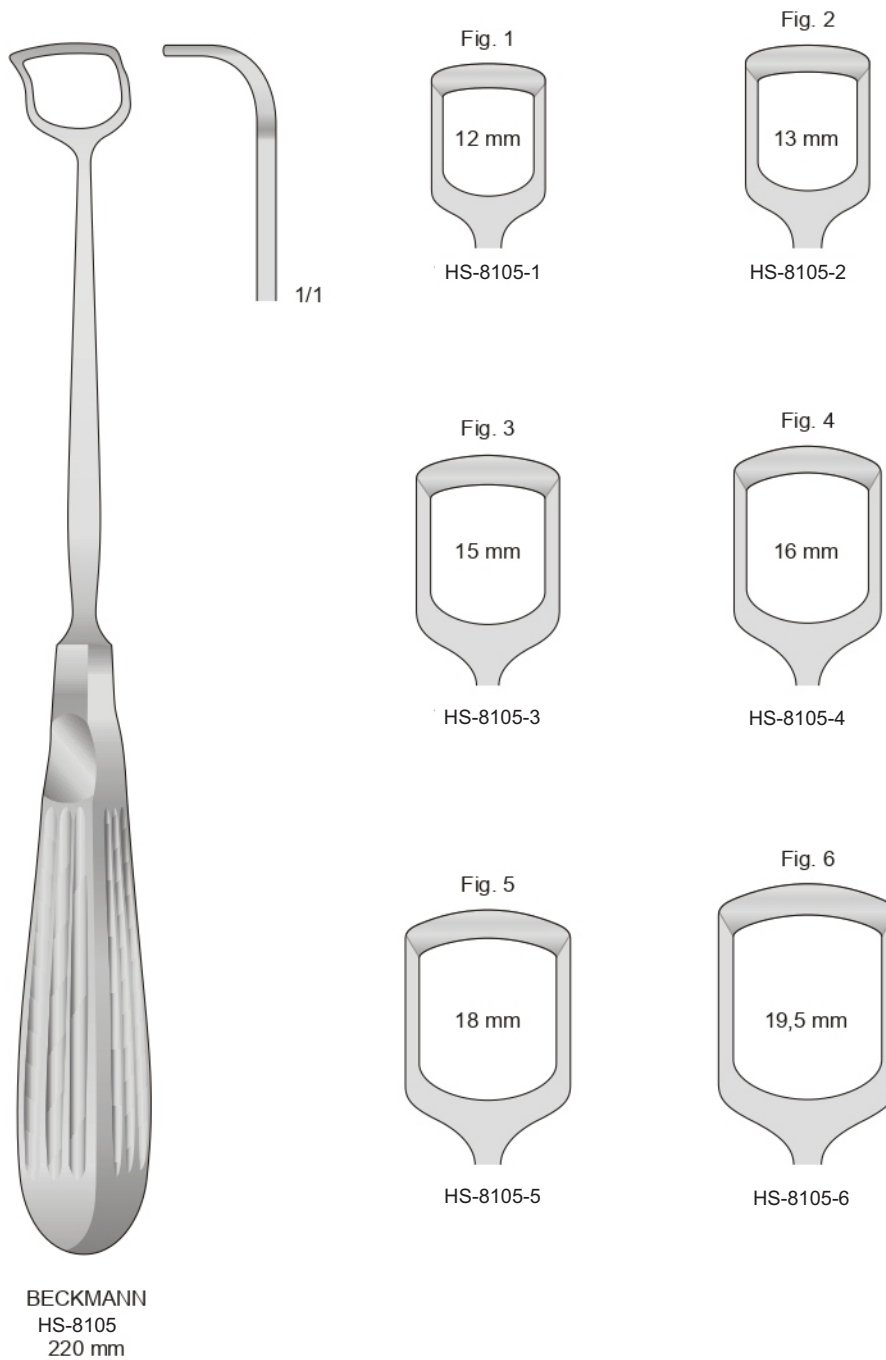

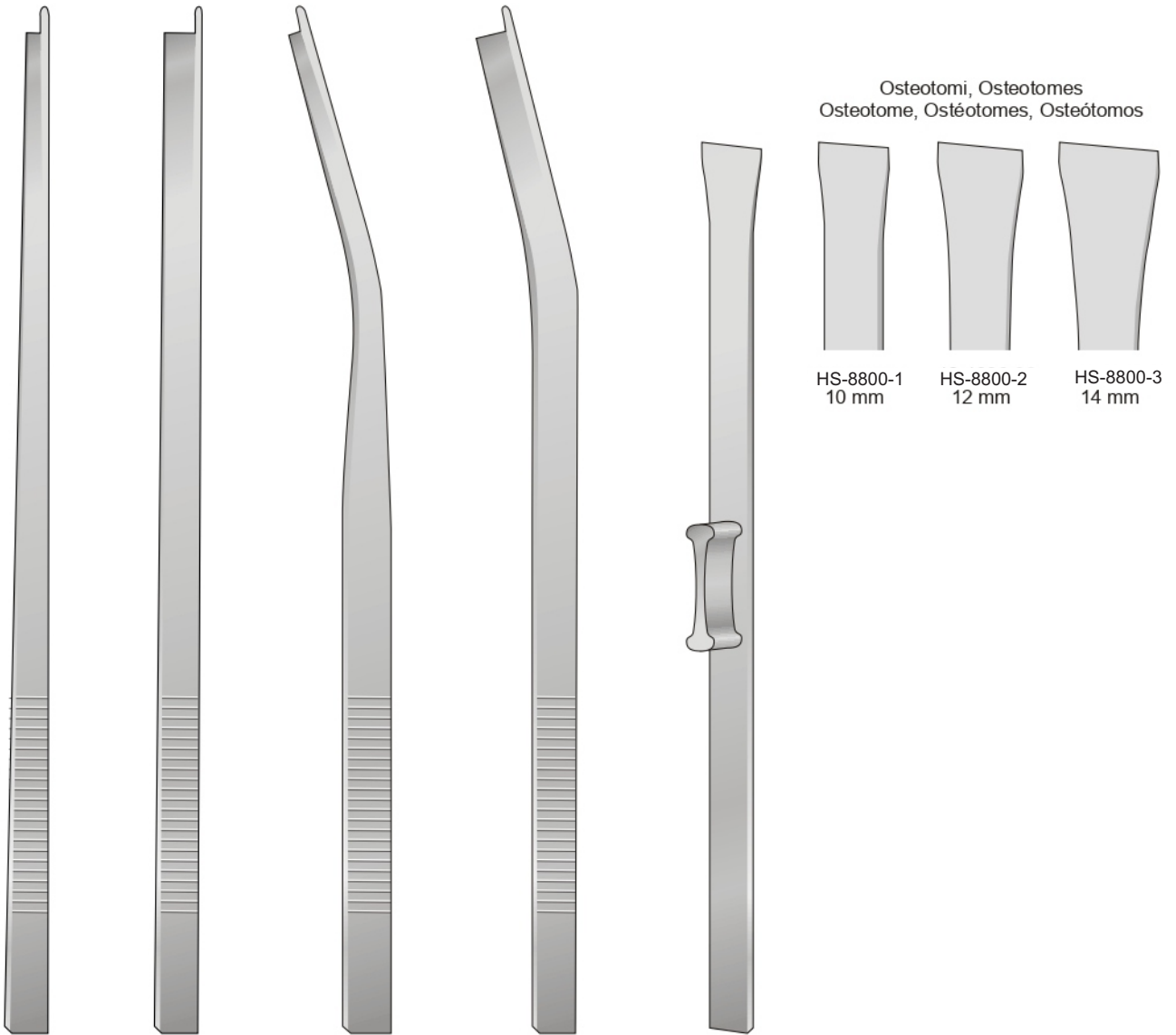

HS-8106-1
200 mm

HS-8106-2
200 mm

HS-8106-3
200 mm

HS-8106-4
200 mm

RUBIN
HS-8107
180 mm

Osteotomi, Osteotomes
 Osteotome, Ostéotomes, Osteótomos

HS-8800-1
10 mm

HS-8800-2
12 mm

HS-8800-3
14 mm

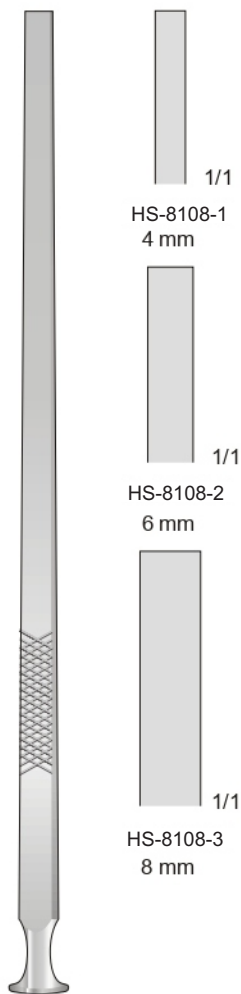

EPKER
HS-8108
180 mm

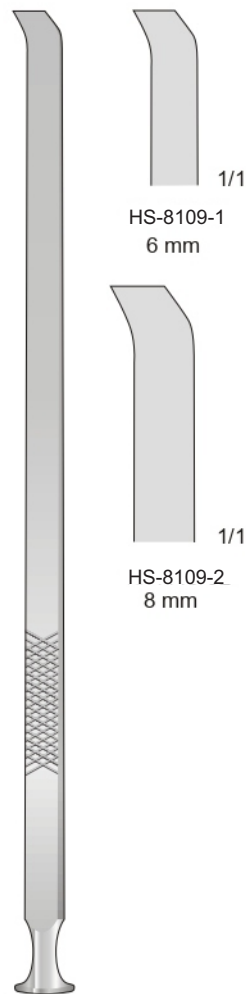

EPKER
HS-8109
180 mm

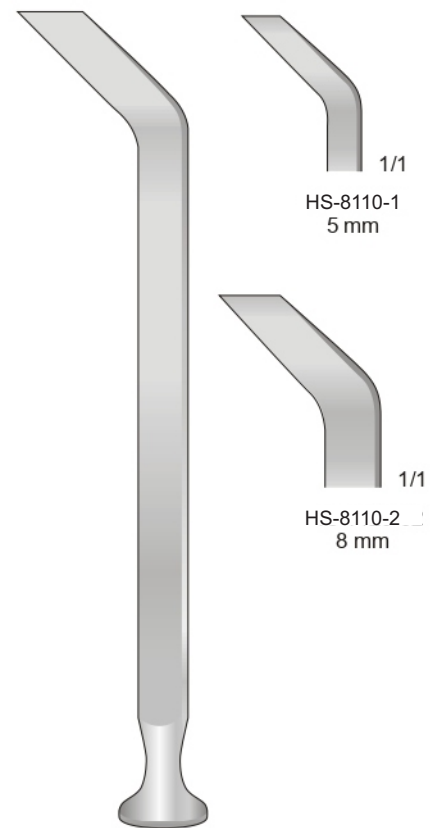

SPLIT
HS-8110
150 mm

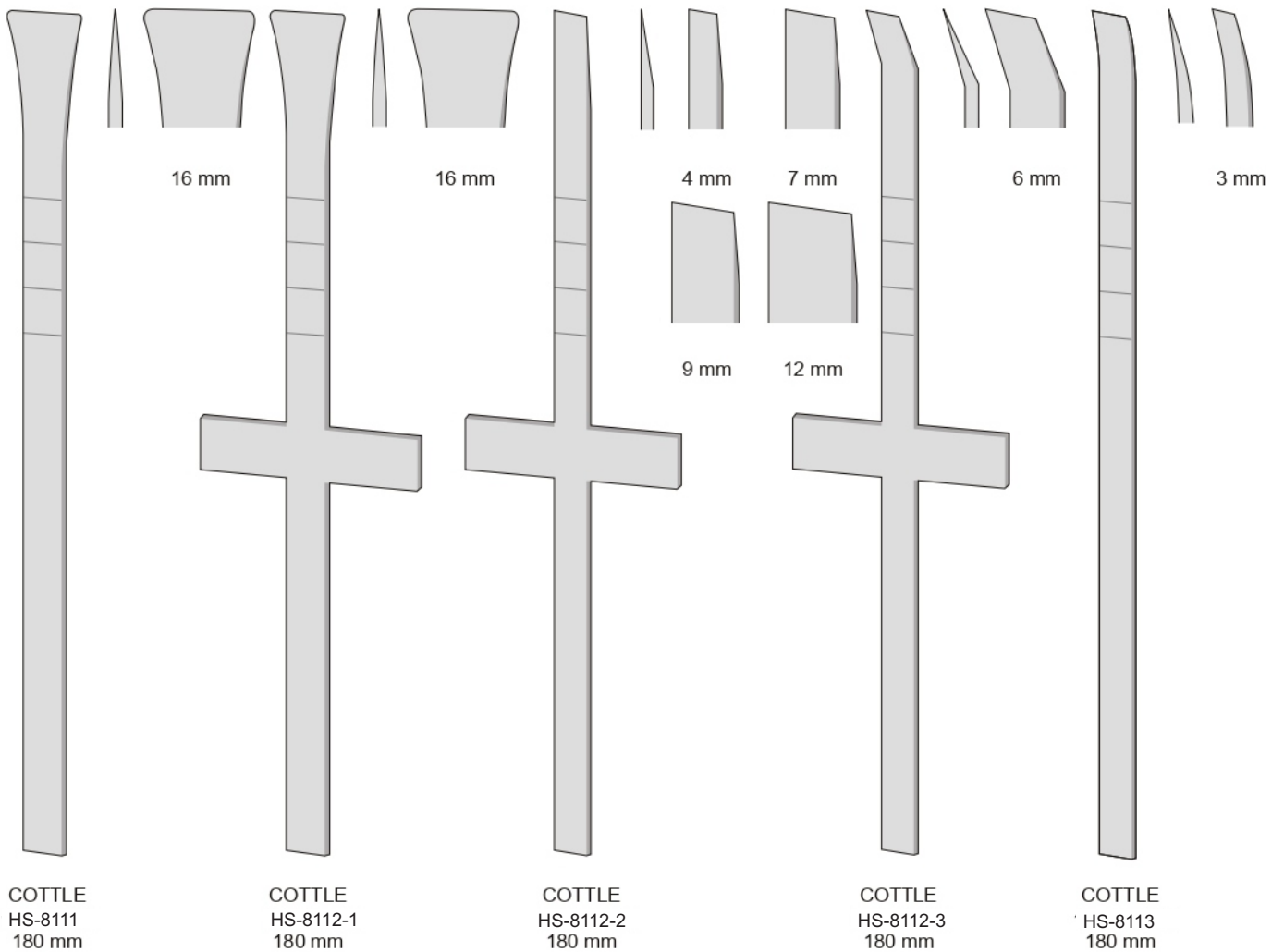

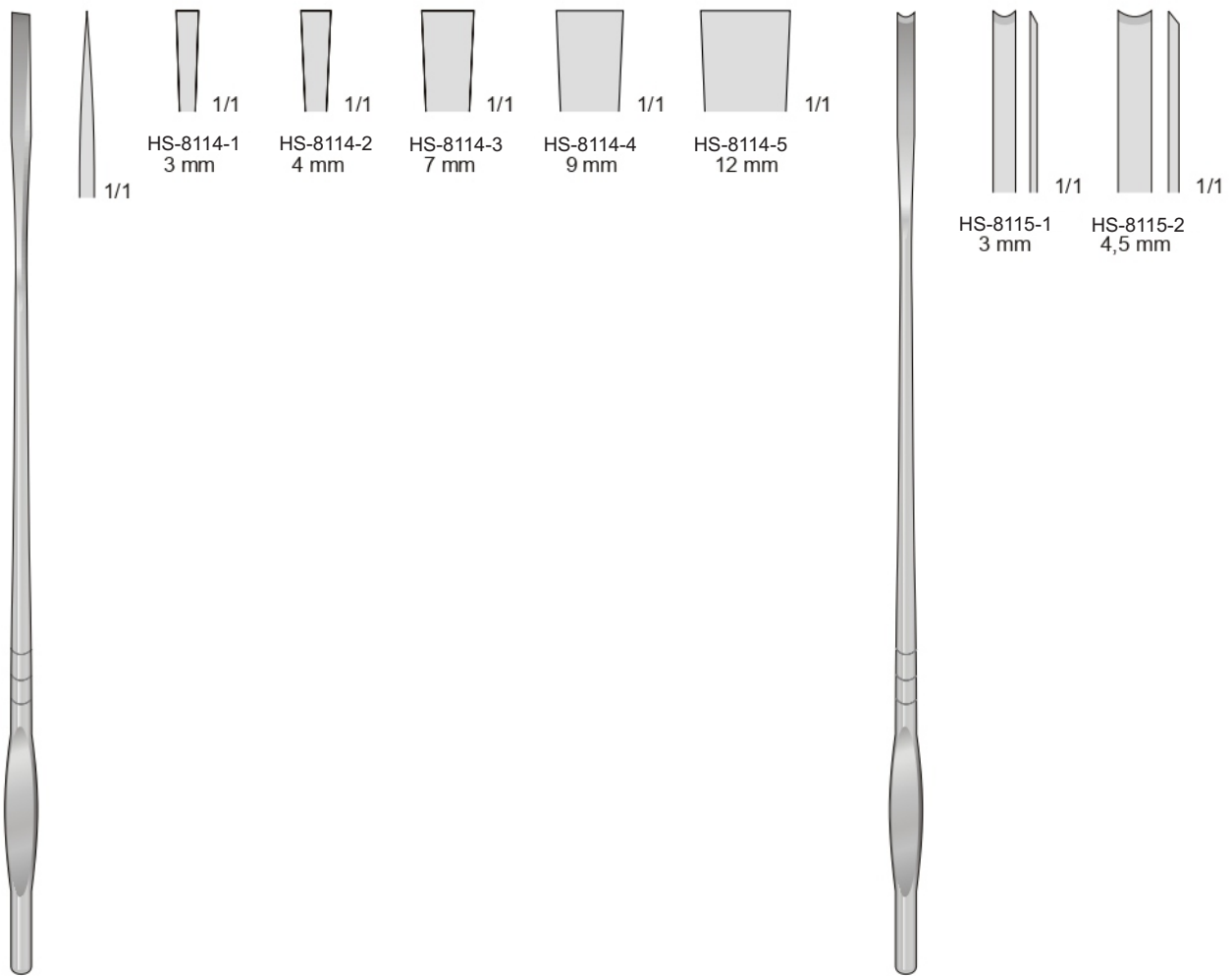

HS-8114
 190 mm

HS-8115
 190 mm

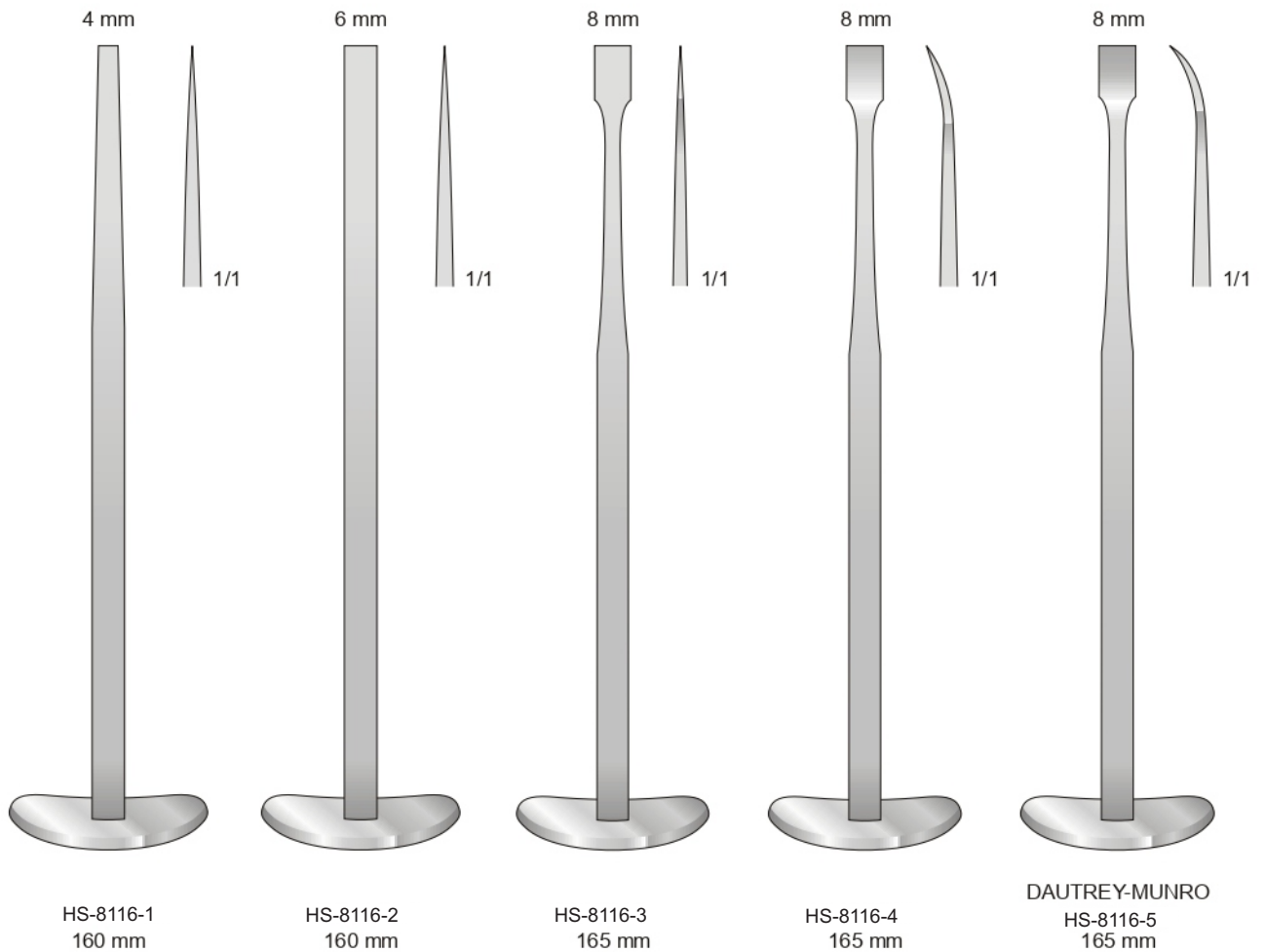

Osteotomes

Osteotomi diritti graduati

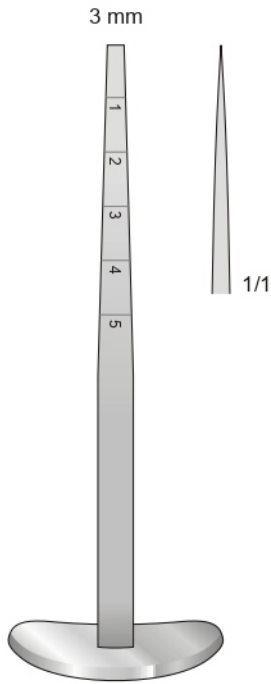

HS-8117-1
115 mm

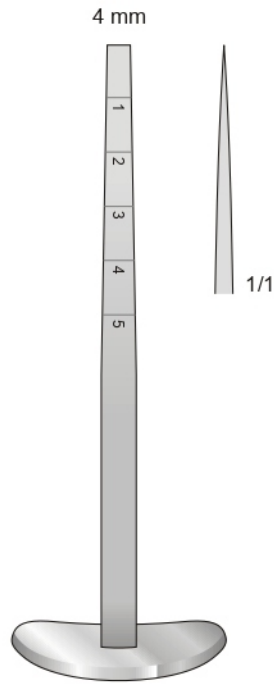

HS-8117-2
115 mm

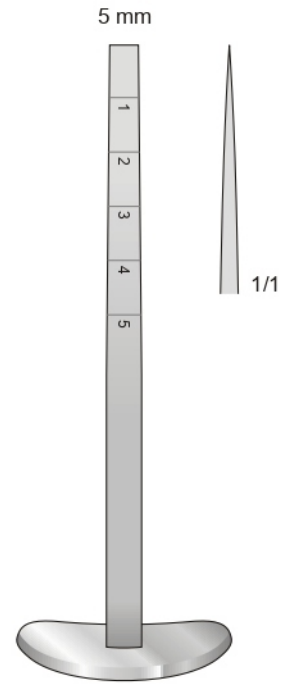

HS-8117-3
115 mm

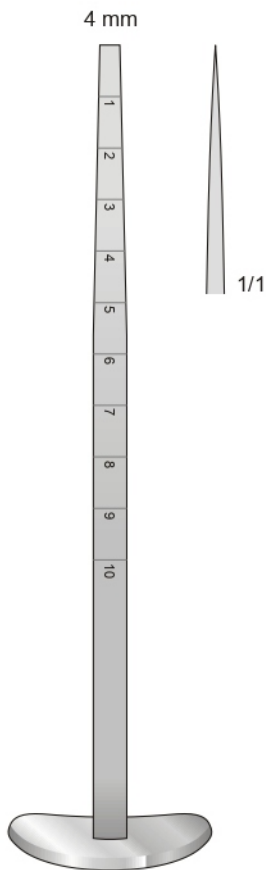

HS-8117-4
160 mm

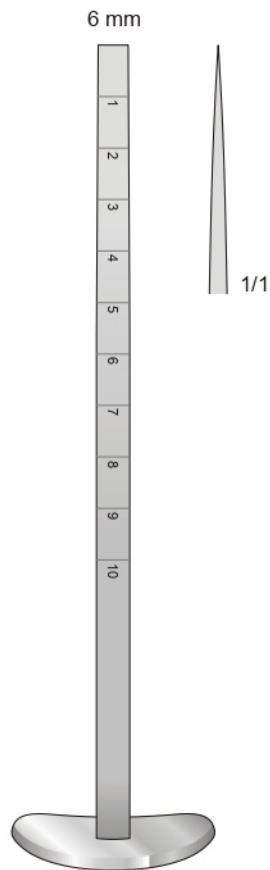

HS-8117-5
160 mm

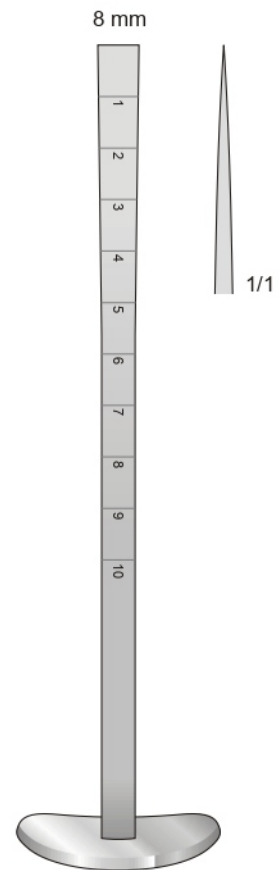

HS-8117-6
160 mm

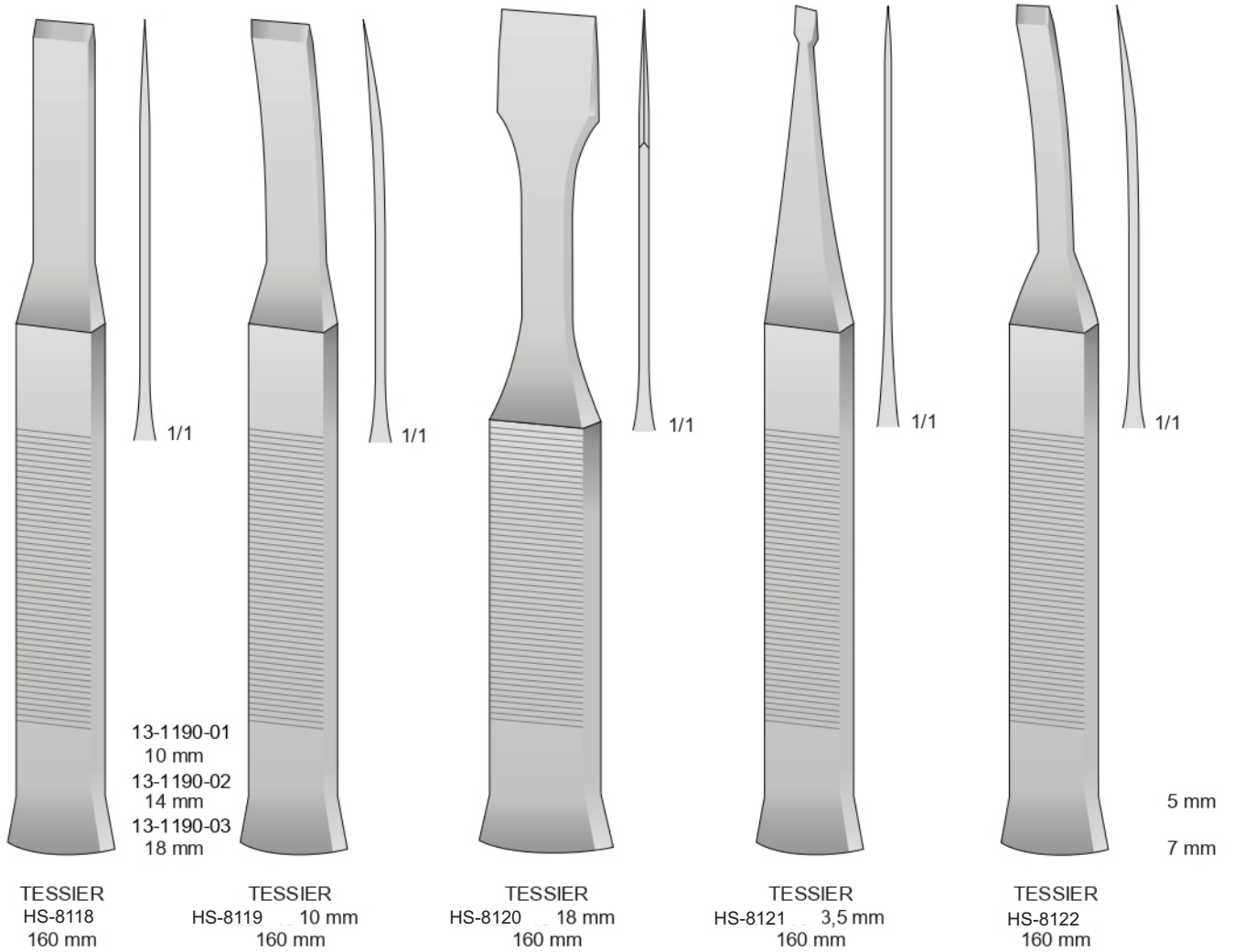

Osteotomi nasali
Nasal Osteotomes
Nasen Osteotome
Ostéotomes nasaux
Osteotomos nasales

Manico in ferrozell
With Ferrozell Handle
Mit Ferrozell-Griff
Avec poignée en Ferrozell
Con mango de Ferrozell

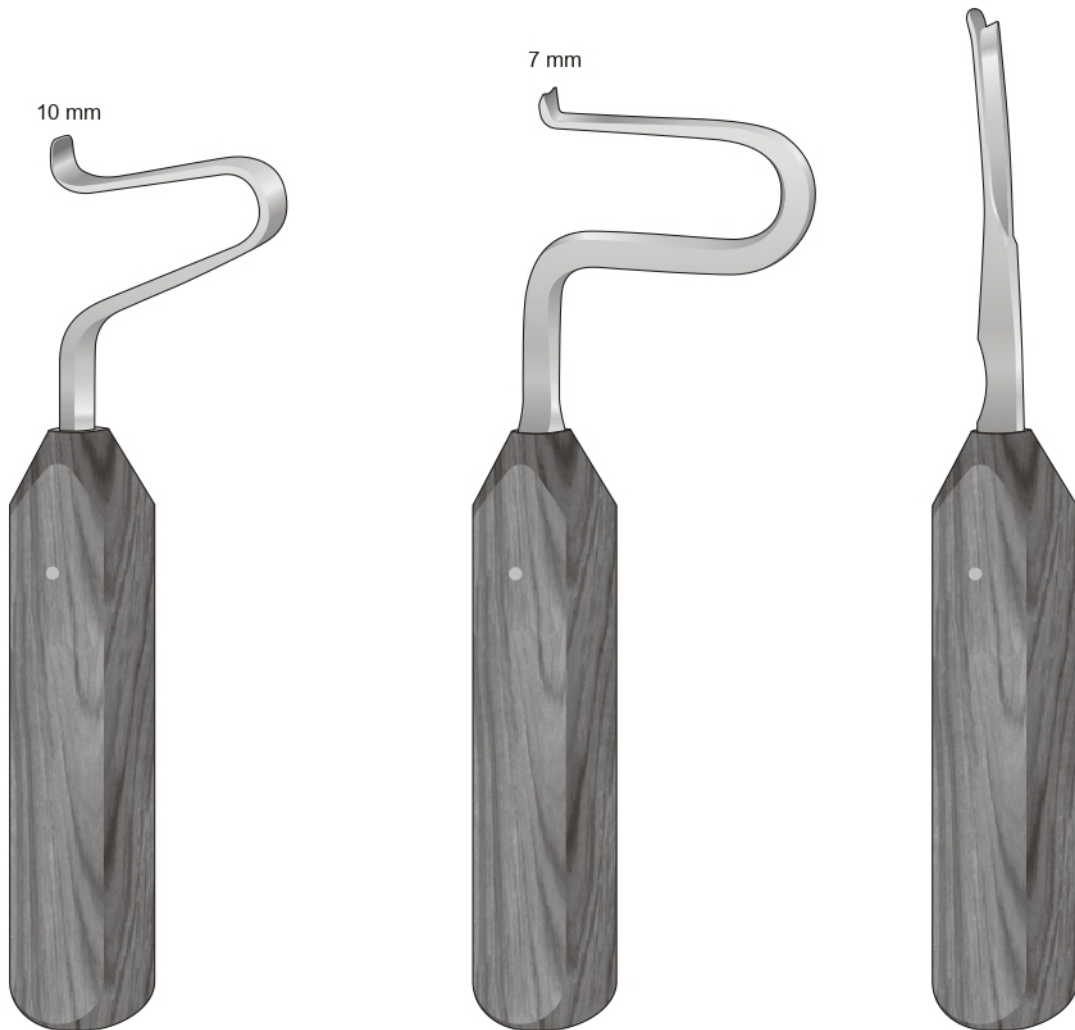

HS-8123-1
170 mm

HS-8123-2
190 mm

HS-8124-1 destro - R
HS-8124-2 sinistro - L
205 mm

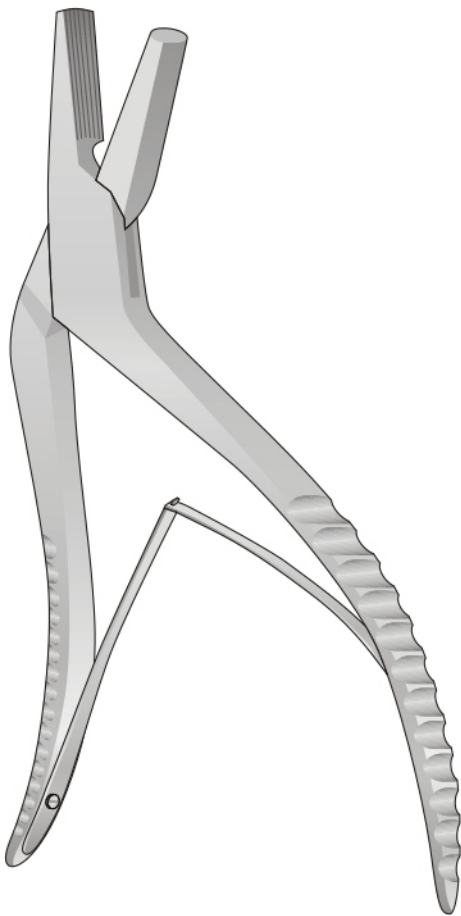

TESSIER
HS-8125
195 mm

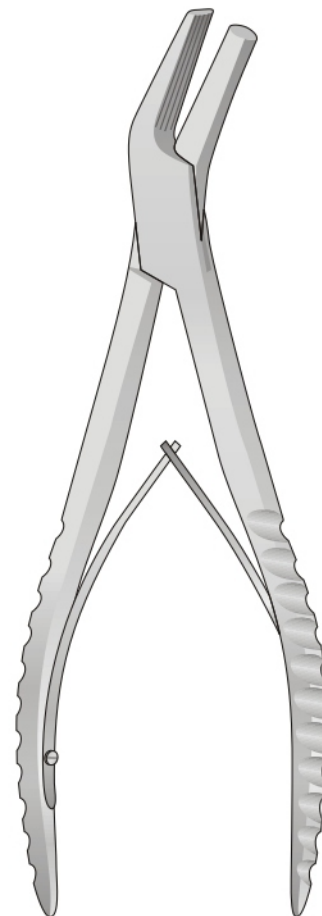

TESSIER
HS-8126
220 mm

Bone cutters
Macina osso

HS-8127-1 Manico ad innesto cm. 19,5
Flexible handle
Abnehmbarer Griff

HS-8127-2 Vaschetta porta-osso con presa
Knochenbehälter
Container for bones

HS-8127-3 Tassello spingi-osso superiore
Oberer Knochen-drücker

HS-8127-4 Grattugia per CIPS fine #1
Reibe für GIPS, fein

HS-8127-5 Grattugia per CIPS grossi #2
Reibe für GIPS, grob

HS-8127
Comprende una
sola grattugia

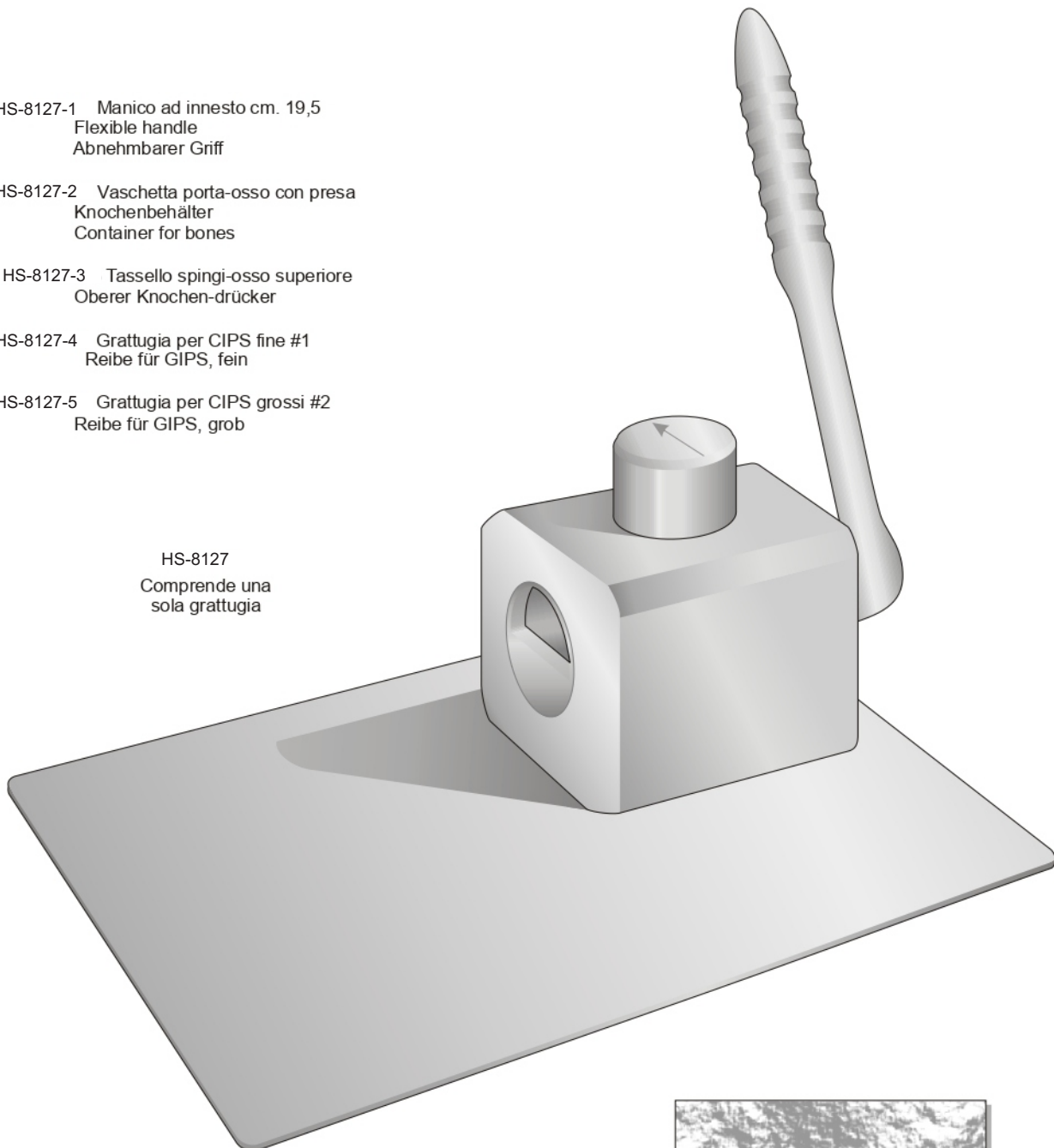

GABON
HS-8128
235 x 160 x 100 mm
Kg 4,5

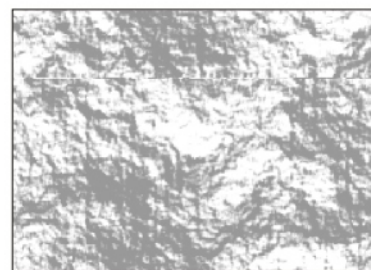

Cips macinato

**Manufacturer & Exporter
Of Surgical, Dental & Beauty Instruments.**



Health Fast Surgical

Surgical Manufacturer Company

+92 (342) 880 9017

+92 (342) 880 9017

info@healthfastsurgical.com

www.healthfastsurgical.com

Dogra Khurd, P.O Harrar Sialkot-51310 Pakistan.



ISO
9001:2008

