



Health Fast Surgical

Surgical Manufacturer Company



www.healthfastsurgical.com

Surgical

INSTRUMENTS CATALOGUE

*Bone Surgery
Laminectomy*

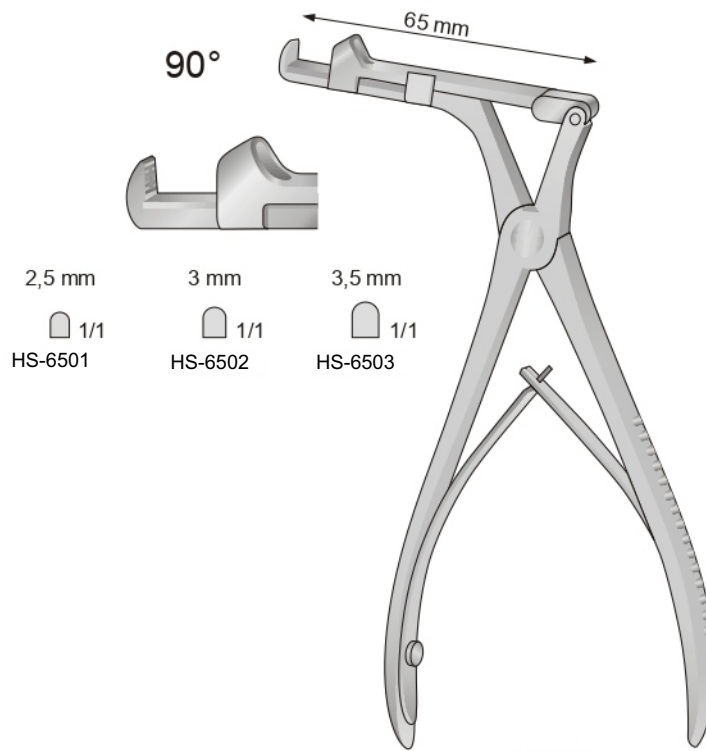

CITELLI
 HS-6501 2,5 mm
 HS-6502 3 mm
 HS-6503 3,5 mm

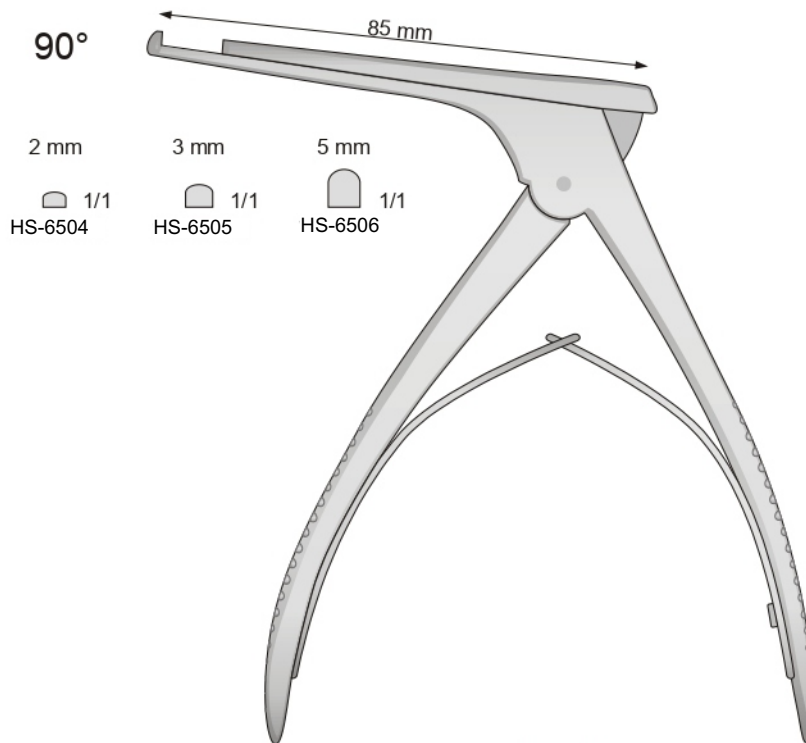

KERRISON
 HS-6504 2 mm
 HS-6505 3 mm
 HS-6506 5 mm

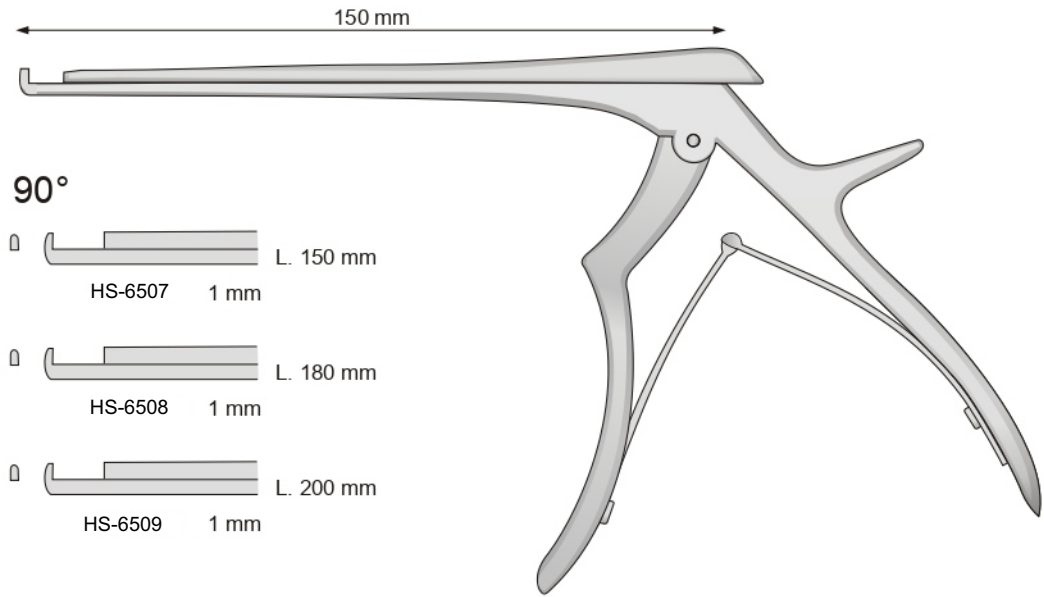

FERRIS-SMITH-KERRISON
HS-6507

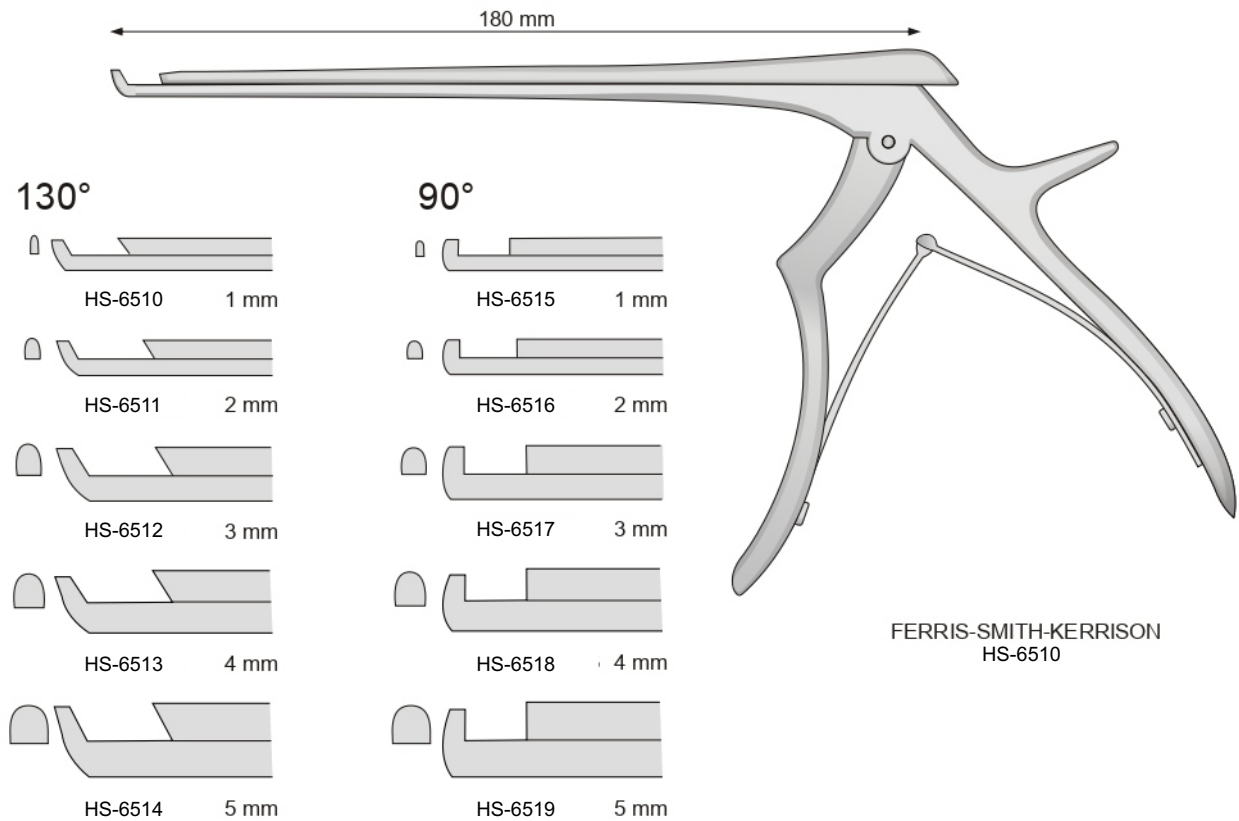

FERRIS-SMITH-KERRISON
HS-6510

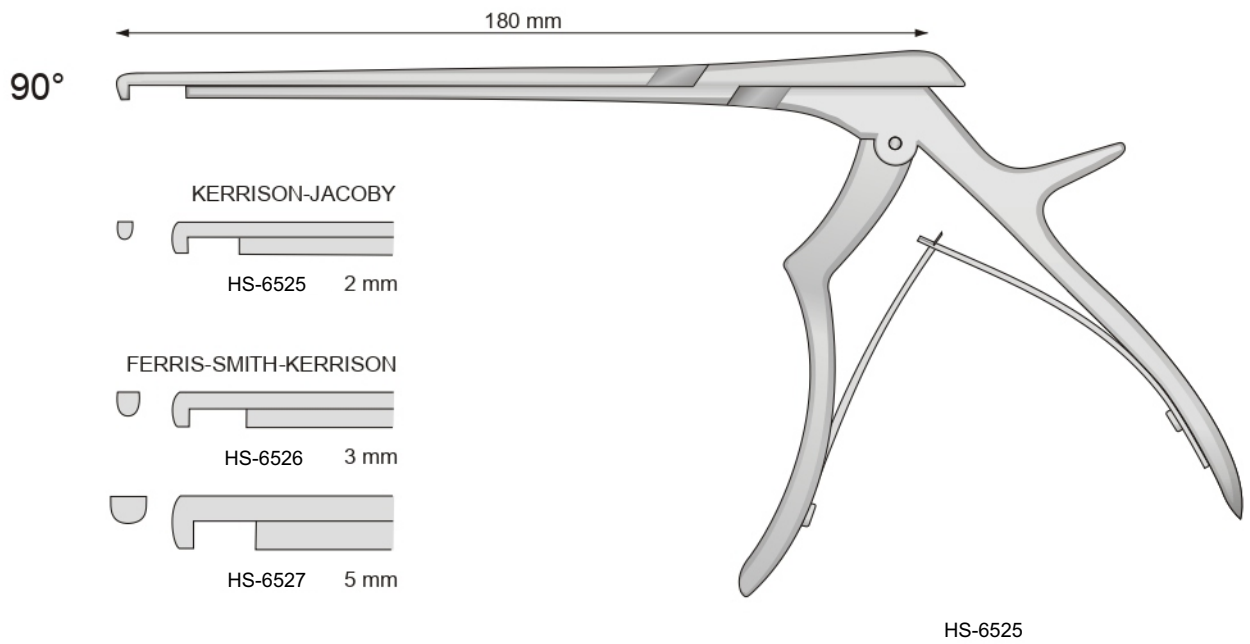
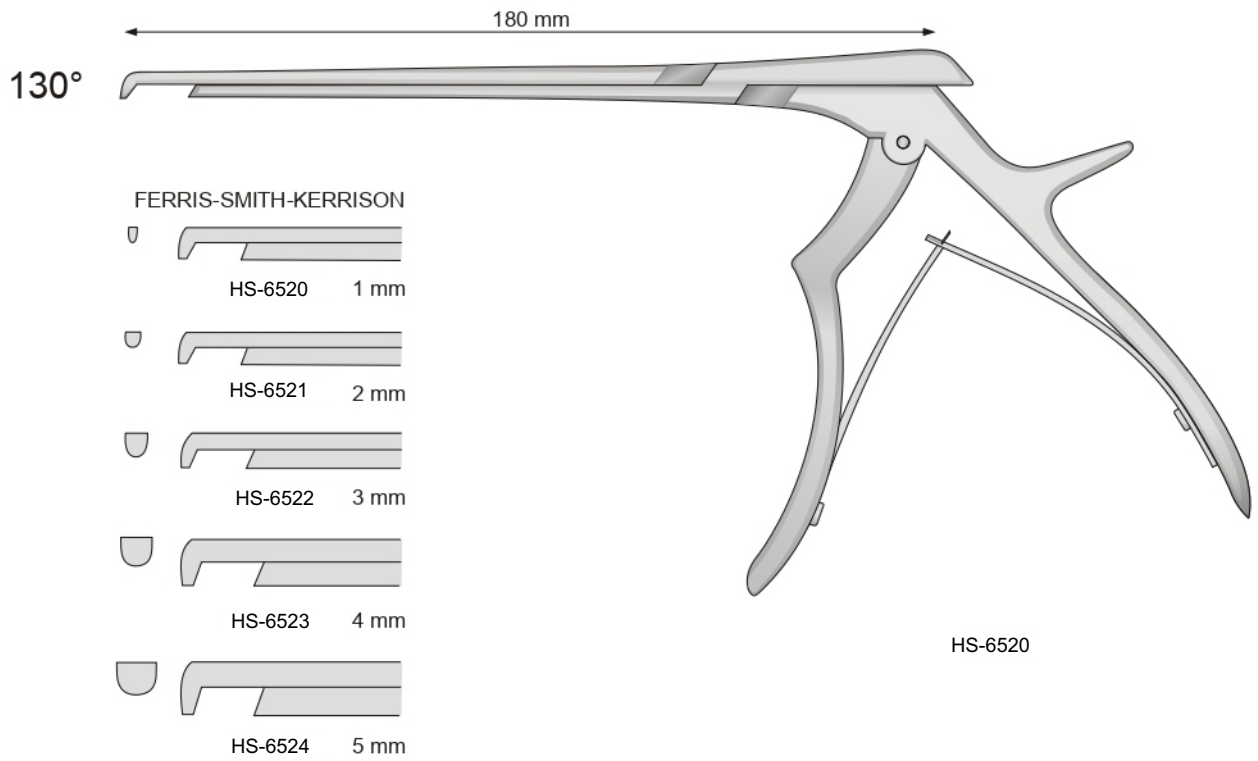

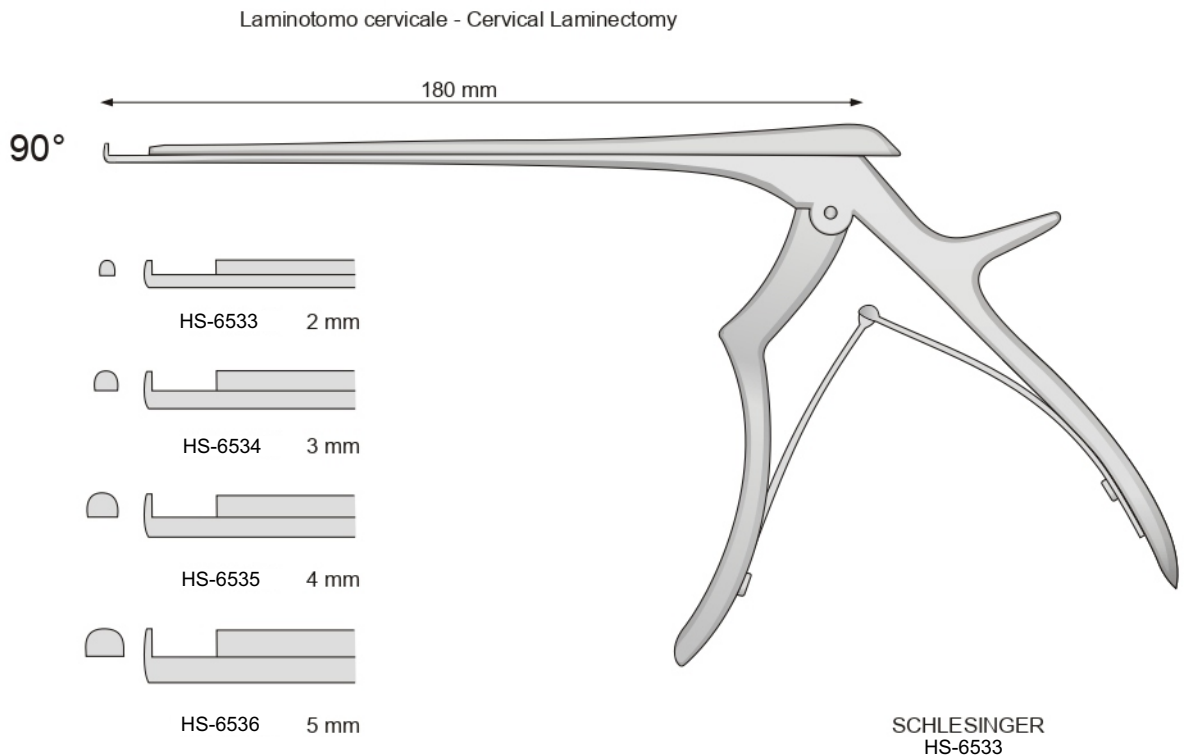
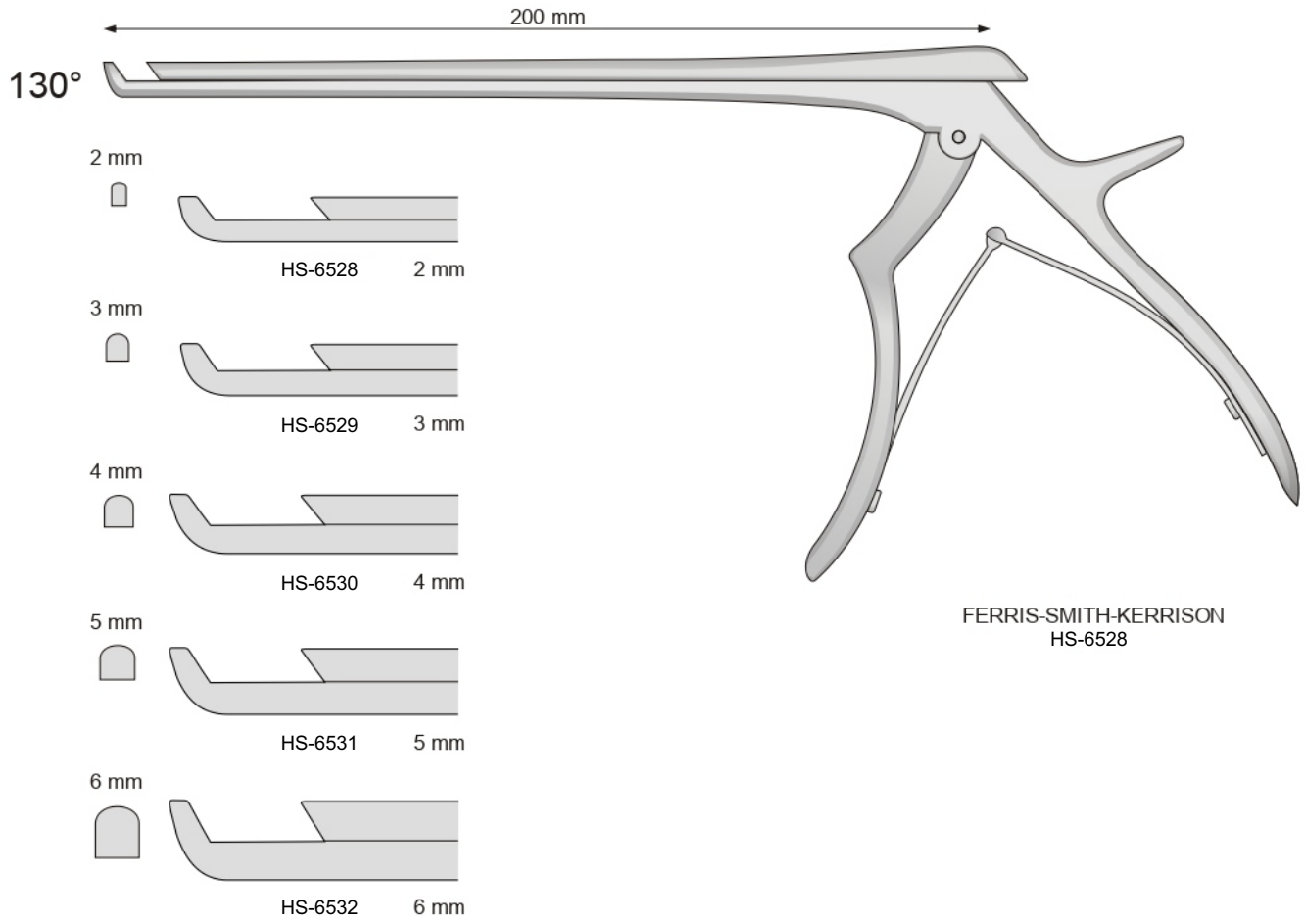

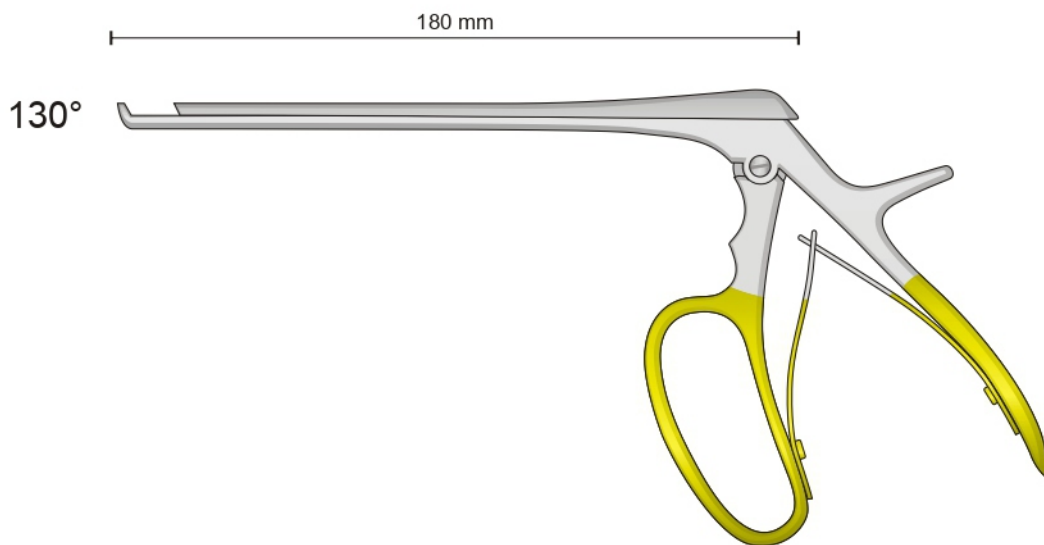
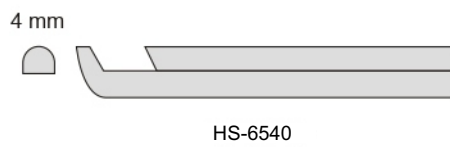
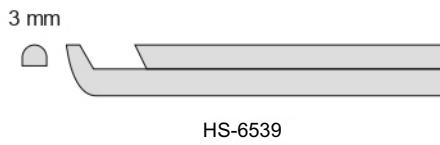
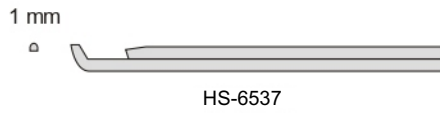





FERRIS - SMITH - KERRISON
HS-6537



Diritta
 Stright
 Gerade
 Droites
 Rectas



-  HS-6542 x 10 mm
-  HS-6543 x 10 mm
-  HS-6544 x 10 mm
-  HS-6545 x 12 mm

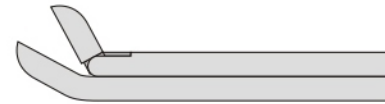

Curva verso l'alto
 Top curved
 Aufwärtsgebogen
 Courbe vers le haut
 Curvos

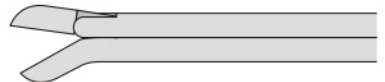

-  HS-6546 x 10 mm
-  HS-6547 x 10 mm
-  HS-6548 x 10 mm

Curva verso il basso
 Bottom curved
 Abwärts gebogen
 Courbe vers le bas
 Curvos



-  HS-6549 x 10 mm
-  HS-6550 x 10 mm
-  HS-6551 x 10 mm

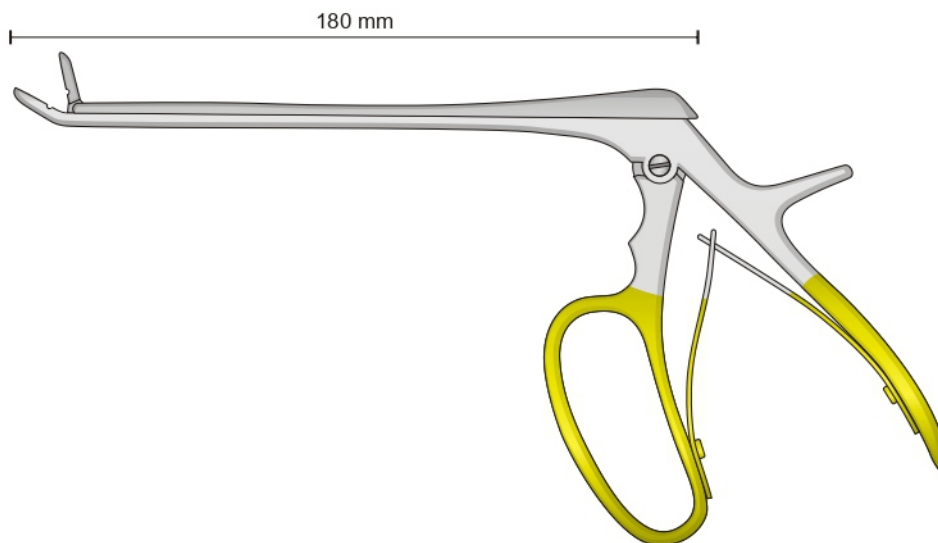

FERRIS - SMITH - CUSHING
 HS-6542

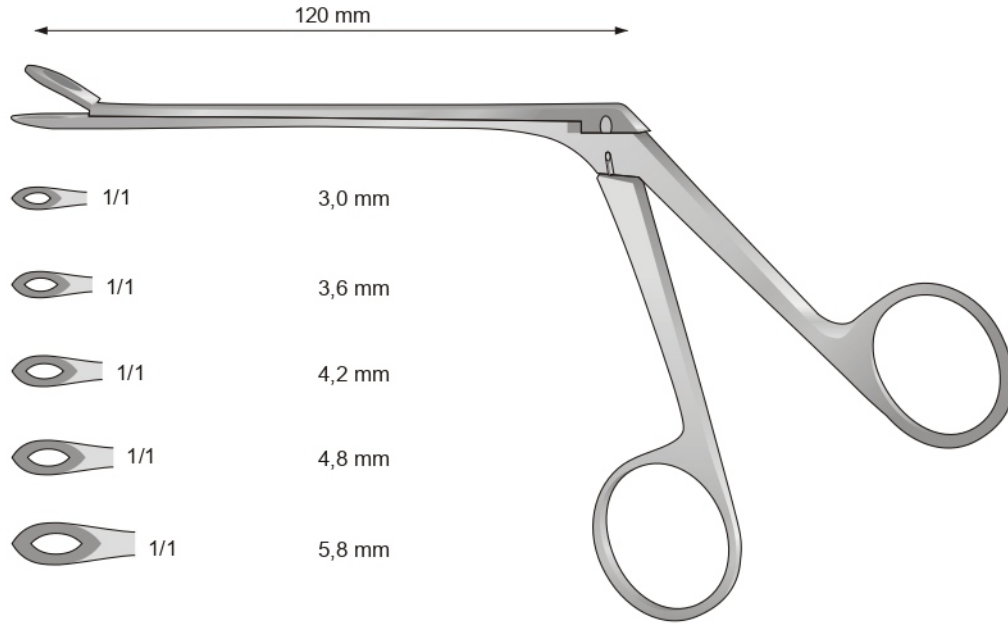

WEIL-BLAKESLEY
 HS-6552
 190mm

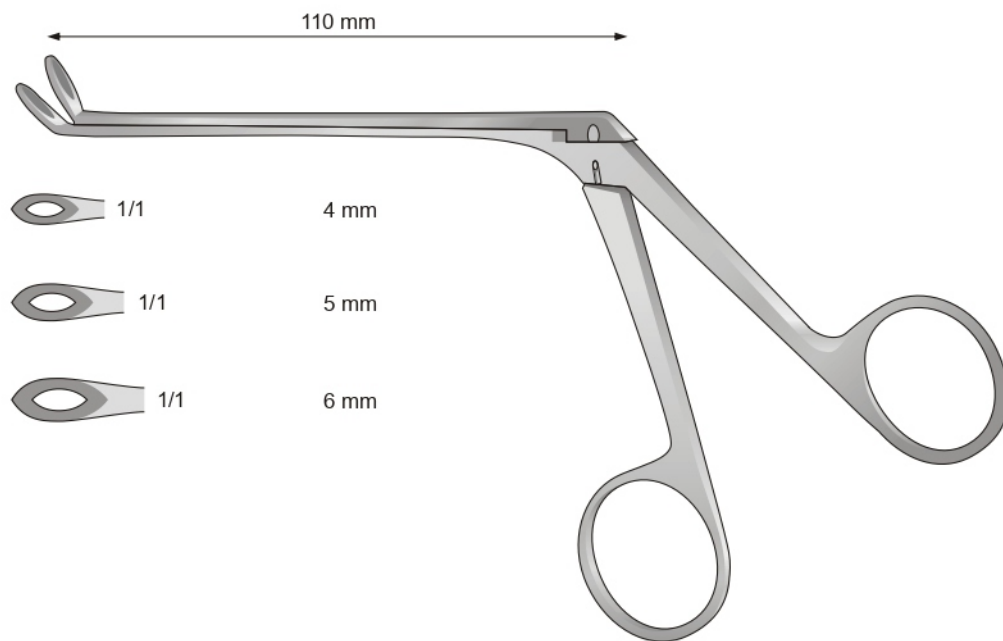

WEIL-BLAKESLEY
 HS-6553
 190mm

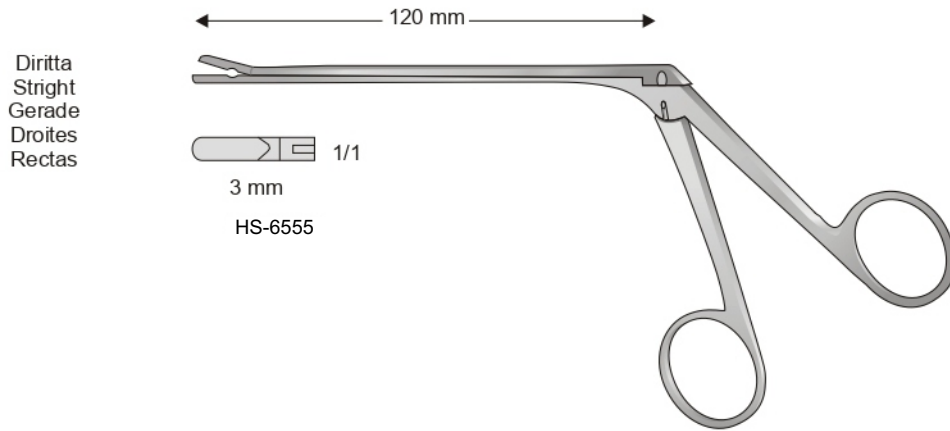

TAKAHASHI
HS-6554

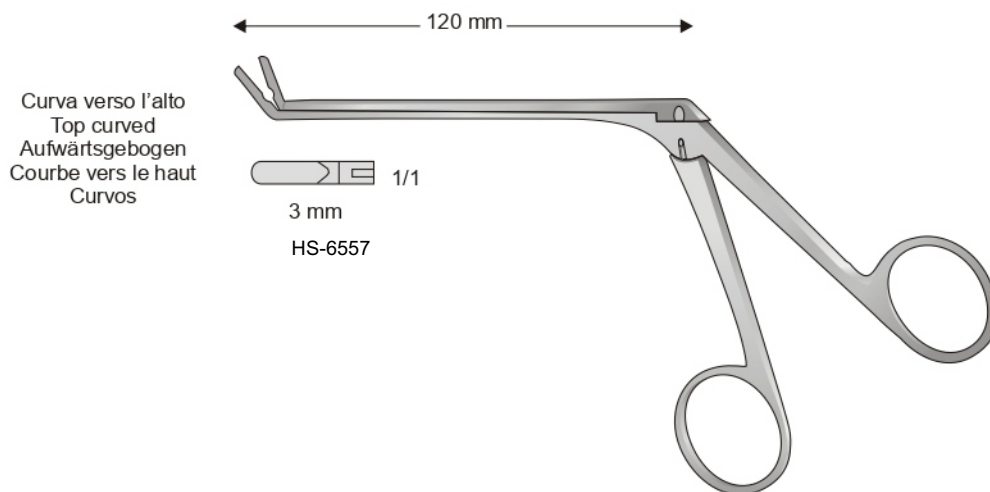

TAKAHASHI
HS-6556

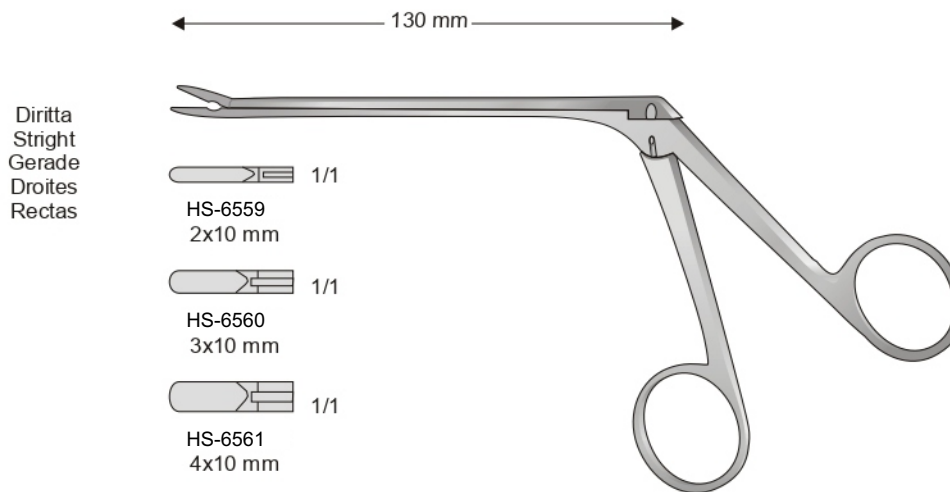



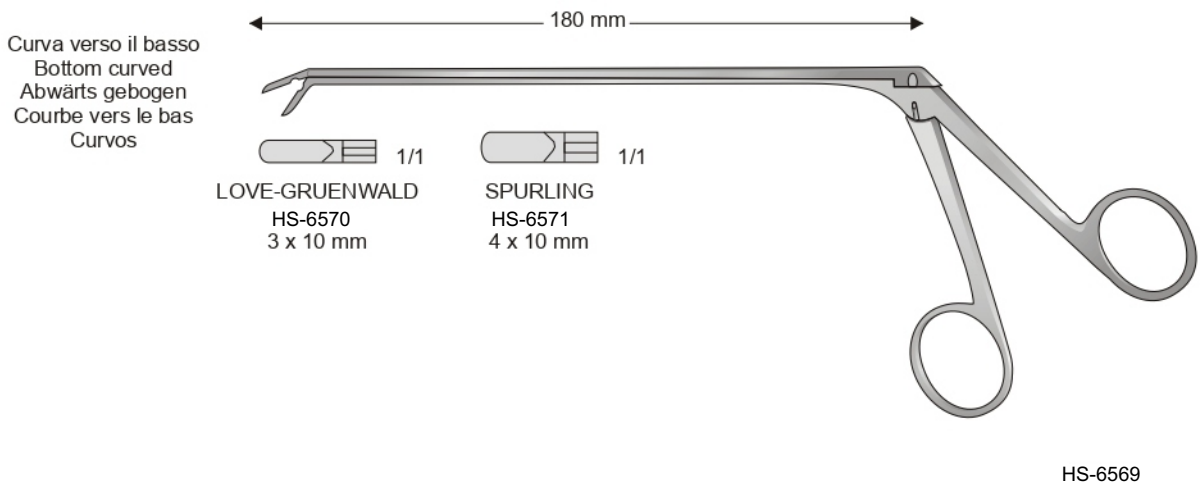
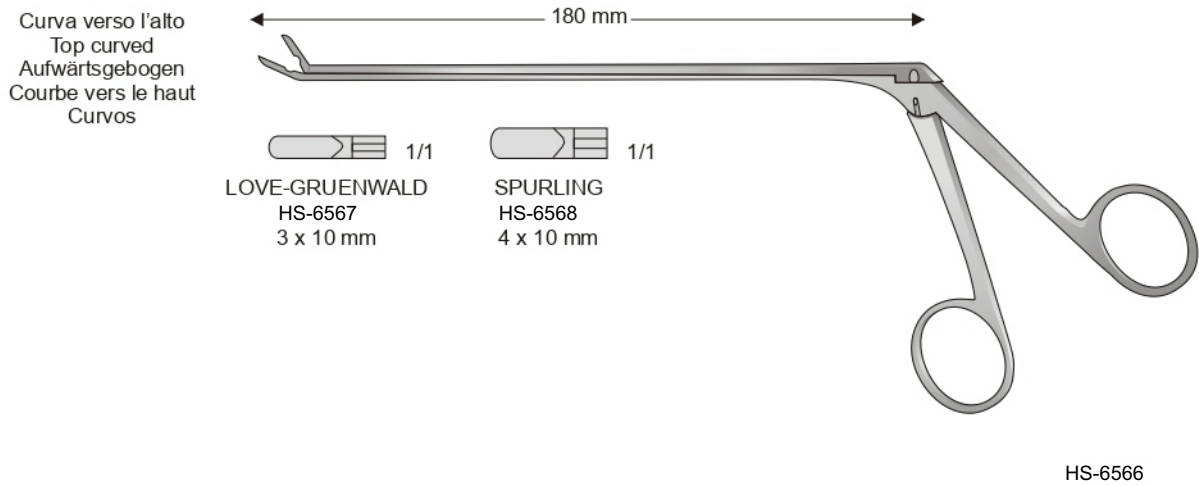
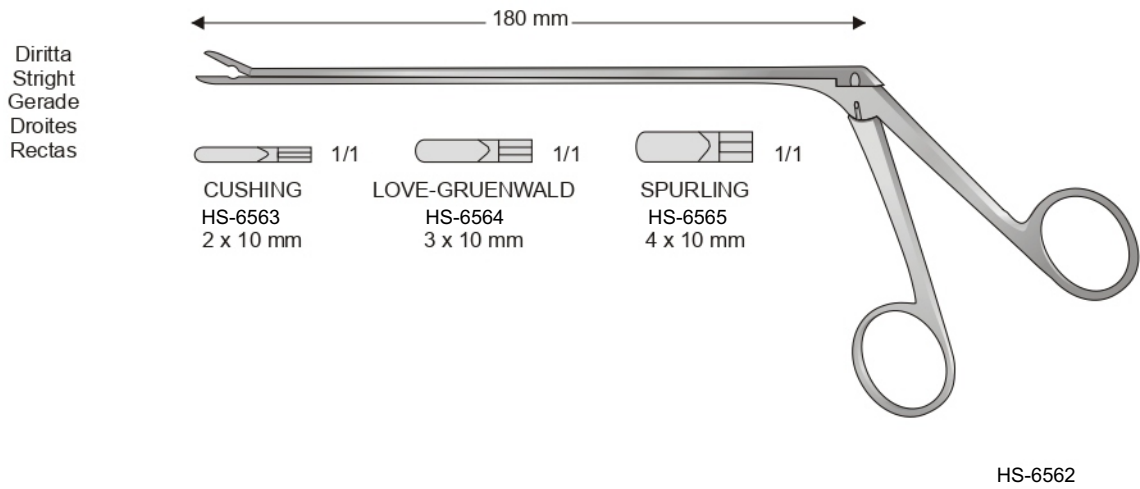

LOVE-GRUENWALD
HS-6558



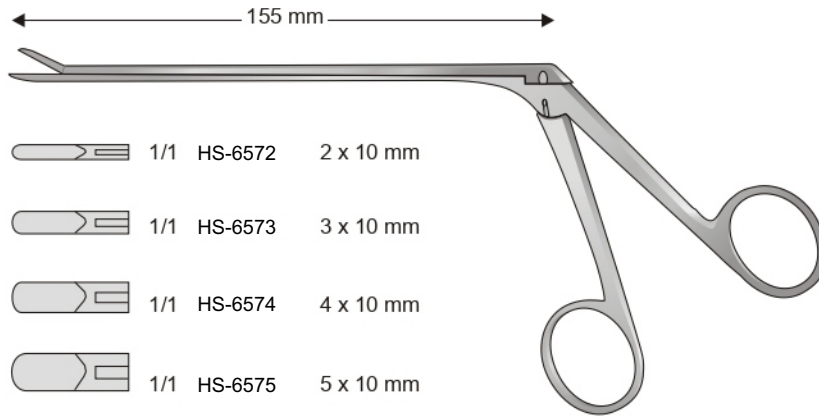

Diritta
Stright
Gerade
Droites
Rectas





- | | | | |
|---|-----|---------|-----------|
|  | 1/1 | HS-6572 | 2 x 10 mm |
|  | 1/1 | HS-6573 | 3 x 10 mm |
|  | 1/1 | HS-6574 | 4 x 10 mm |
|  | 1/1 | HS-6575 | 5 x 10 mm |

CASPAR
HS-6572

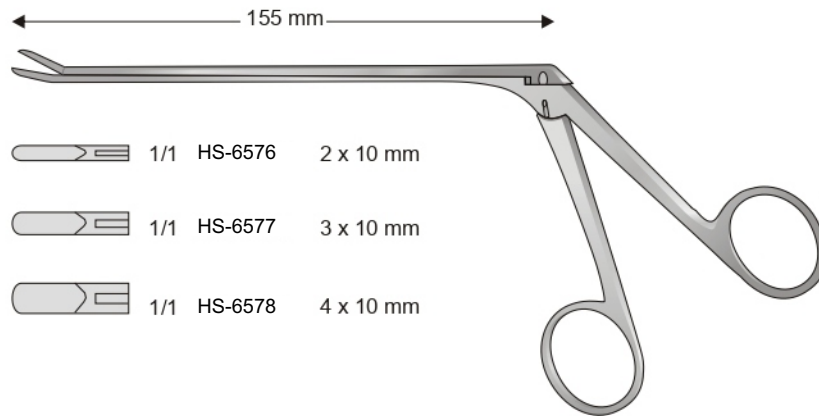
Curva verso l'alto
Top curved
Aufwärtsgebogen
Courbe vers le haut
Curvos





- | | | | |
|---|-----|---------|-----------|
|  | 1/1 | HS-6576 | 2 x 10 mm |
|  | 1/1 | HS-6577 | 3 x 10 mm |
|  | 1/1 | HS-6578 | 4 x 10 mm |

CASPAR
HS-6576

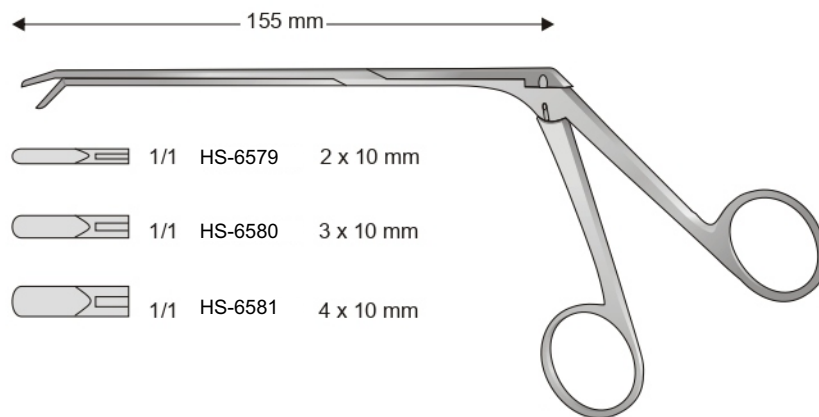
Curva verso il basso
Bottom curved
Abwärts gebogen
Courbe vers le bas
Curvos





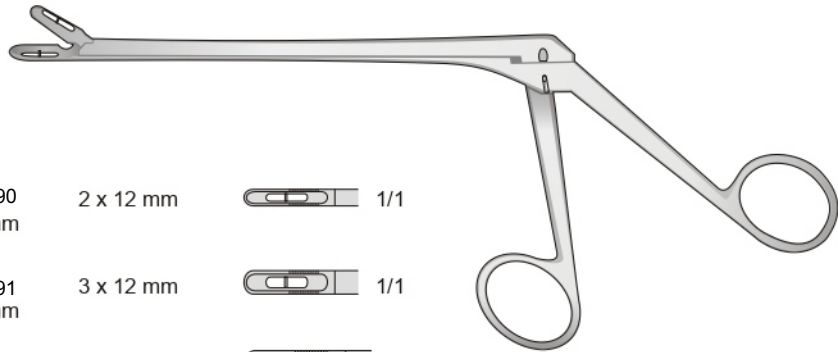

- | | | | |
|---|-----|---------|-----------|
|  | 1/1 | HS-6579 | 2 x 10 mm |
|  | 1/1 | HS-6580 | 3 x 10 mm |
|  | 1/1 | HS-6581 | 4 x 10 mm |

CASPAR
HS-6579

Diritta
Stright
Gerade
Droites
Rectas



CASPAR

| | | | | | |
|-------------------|-------------------|-------------------|-----------|---|-----|
| HS-6582 140 mm | HS-6585 160 mm | HS-6590 185 mm | 2 x 12 mm |  | 1/1 |
| HS-6583 140 mm | HS-6586 160 mm | HS-6591 185 mm | 3 x 12 mm |  | 1/1 |
| HS-6584 140 mm | HS-6587 160 mm | HS-6592 185 mm | 4 x 14 mm |  | 1/1 |
| | HS-6588 160 mm | HS-6593 185 mm | 5 x 14 mm |  | 1/1 |
| | HS-6589 160 mm | HS-6594 185 mm | 6 x 16 mm |  | 1/1 |



CASPAR
HS-6582

Curva verso l'alto
Top curved
Aufwärtsgebogen
Courbe vers le haut
Curvos

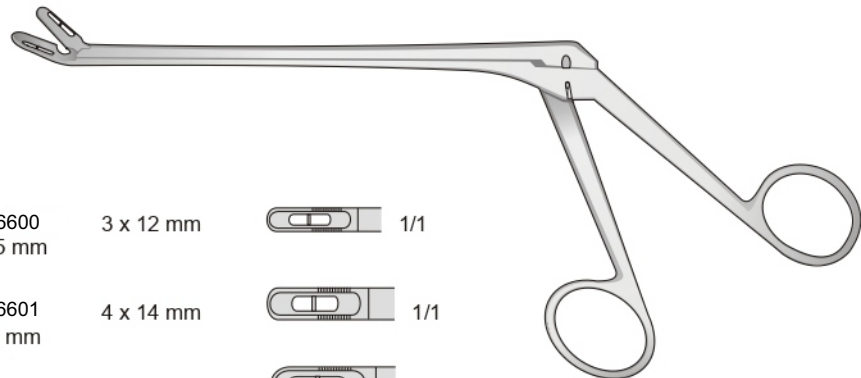
150°



CASPAR

| | | | | | |
|-------------------|-------------------|-------------------|-----------|---|-----|
| HS-6595 140 mm | HS-6597 160 mm | HS-6600 185 mm | 3 x 12 mm |  | 1/1 |
| HS-6596 140 mm | HS-6598 160 mm | HS-6601 185 mm | 4 x 14 mm |  | 1/1 |
| | HS-6599 160 mm | HS-6602 185 mm | 5 x 14 mm |  | 1/1 |

CASPAR
HS-6595

Curva verso il basso
Bottom curved
Abwärts gebogen
Courbe vers le bas
Curvos

150°

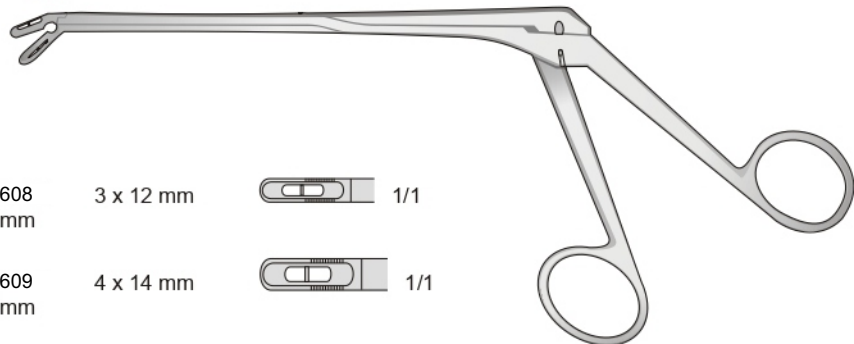

CASPAR

| | | | | | |
|-------------------|-------------------|-------------------|-----------|---|-----|
| HS-6604 140 mm | HS-6606 160 mm | HS-6608 185 mm | 3 x 12 mm |  | 1/1 |
| HS-6605 140 mm | HS-6607 160 mm | HS-6609 185 mm | 4 x 14 mm |  | 1/1 |

CASPAR
HS-6603

Diritta
Stright
Gerade
Droites
Rectas

← 210 mm →

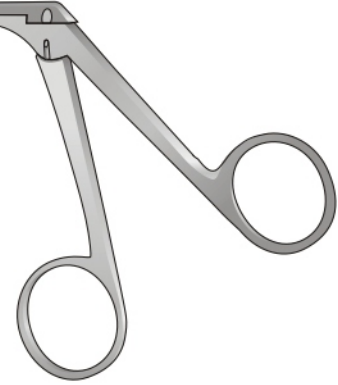
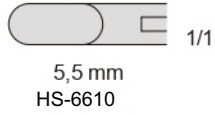

WAGNER
HS-6610

Diritta
Stright
Gerade
Droites
Rectas

← 255 mm →

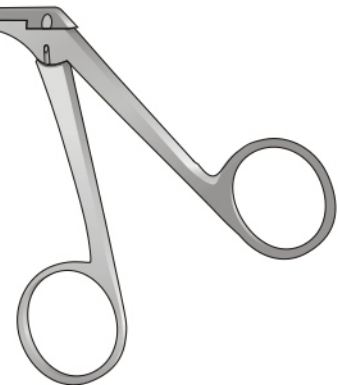
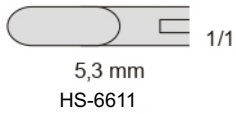

HS-6611

Curva verso l'alto
Top curved
Aufwärtsgebogen
Courbe vers le haut
Curvos

← 255 mm →

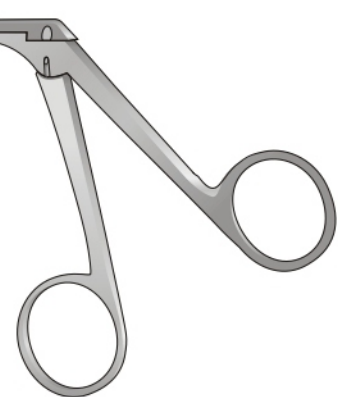

SYPERT
HS-6612

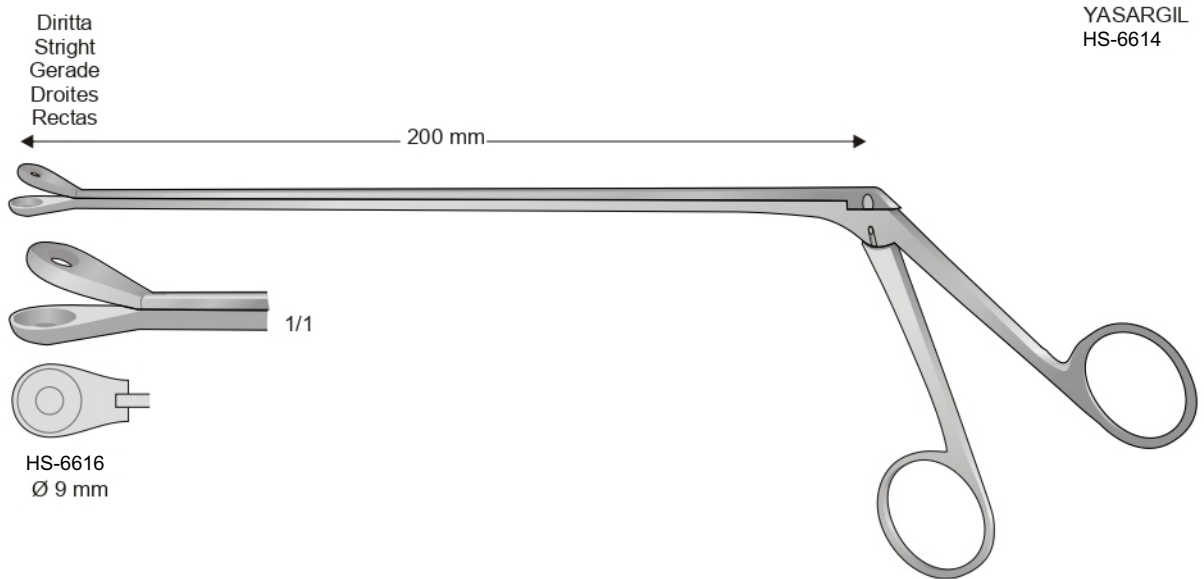
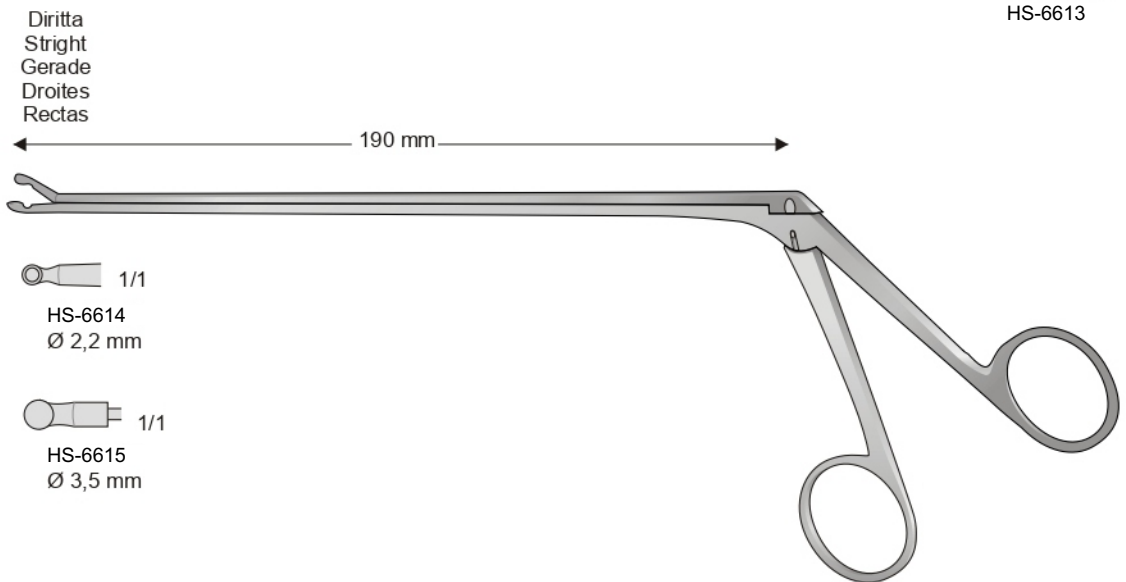
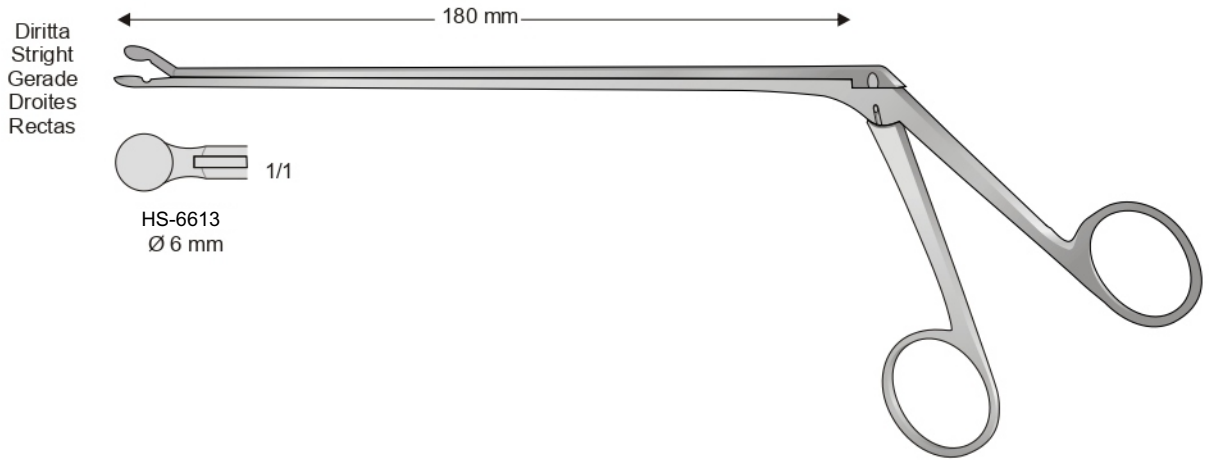

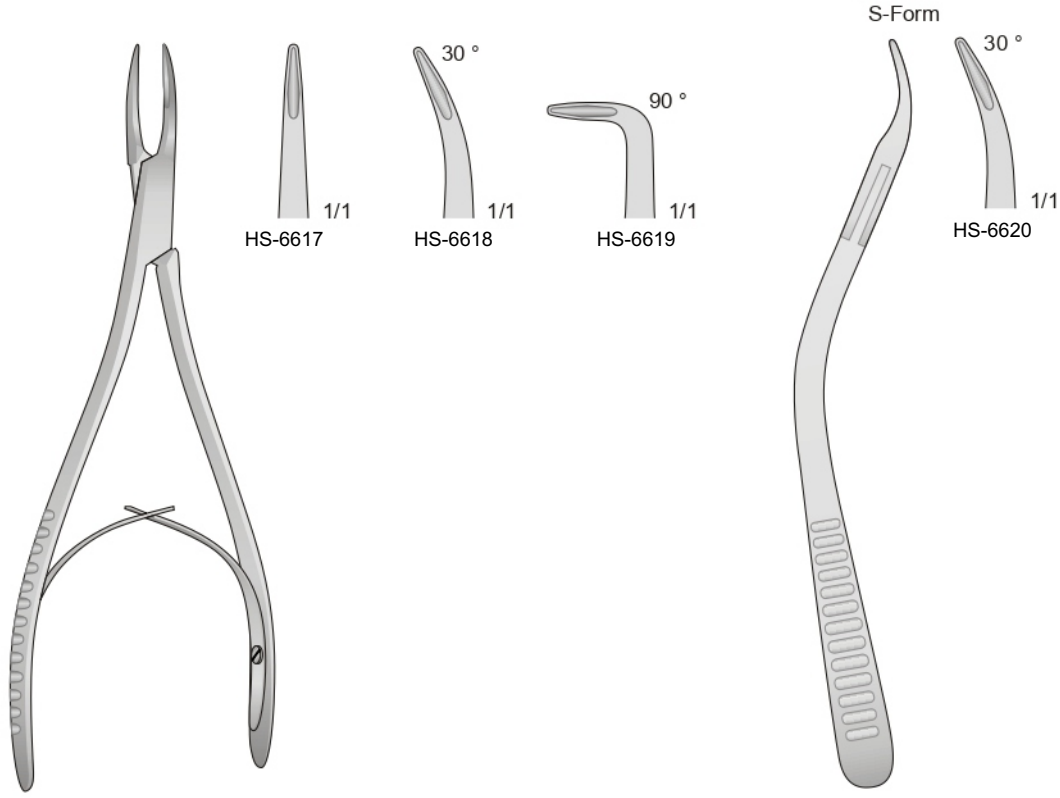

MINI-FRIEDMANN
HS-6617
150 mm

MINI-FRIEDMANN
HS-6620
145 mm

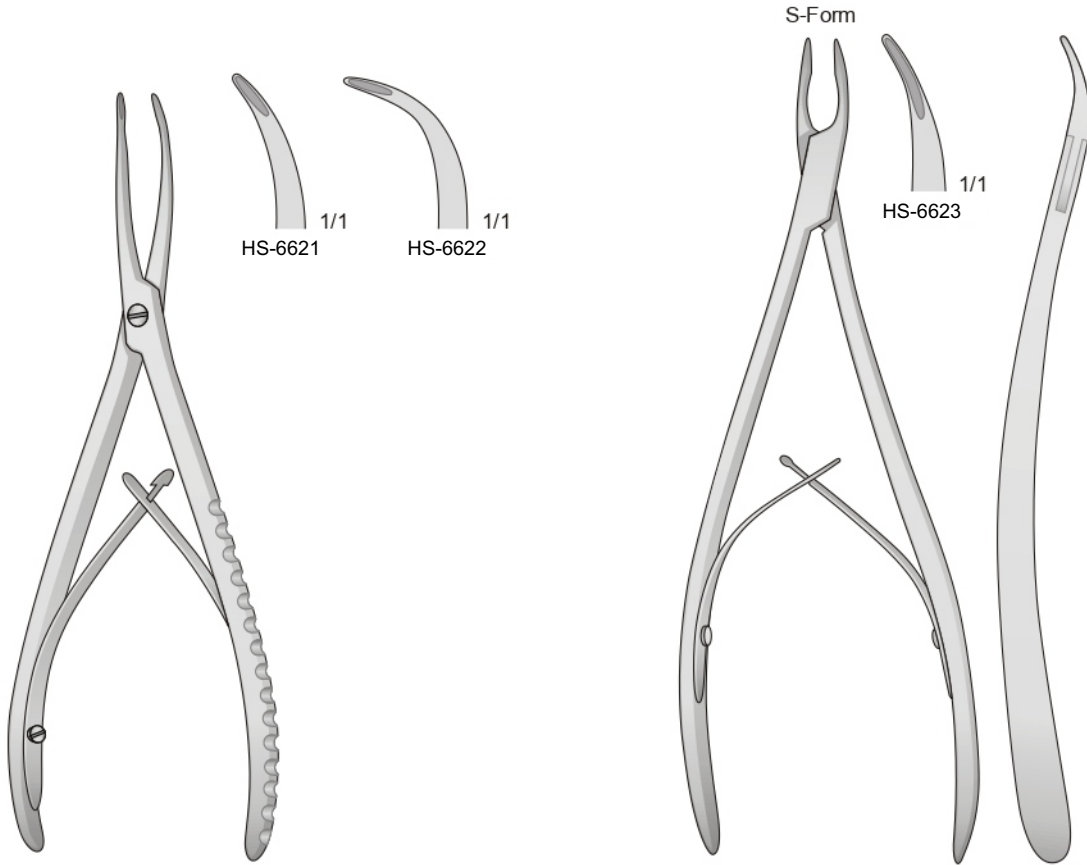

STELLBRINK
HS-6621
170 mm

STELLBRINK
HS-6623
190 mm

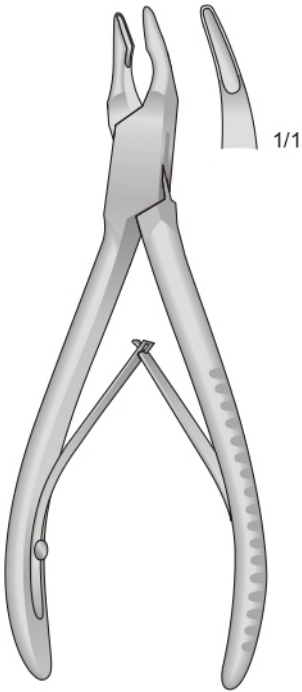

MINI FRIEDMANN
 HS-6624
 120 mm

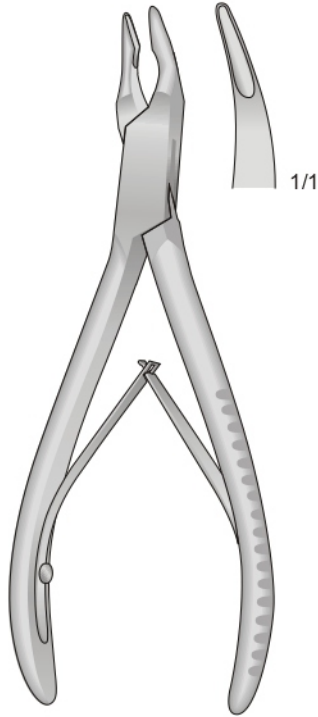

FRIEDMANN
 HS-6625
 140 mm

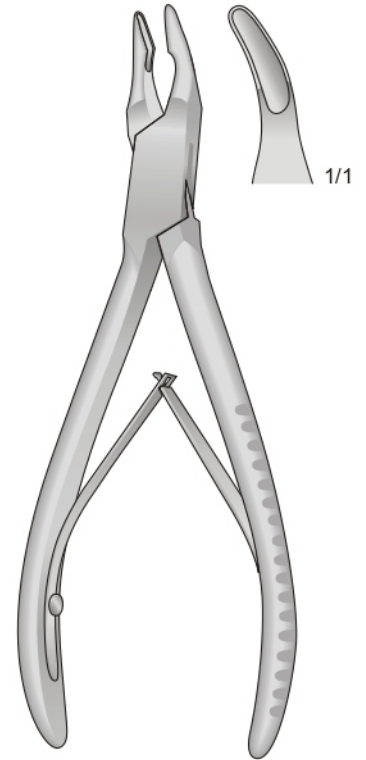

BLUMENTHAL
 HS-6626
 155 mm

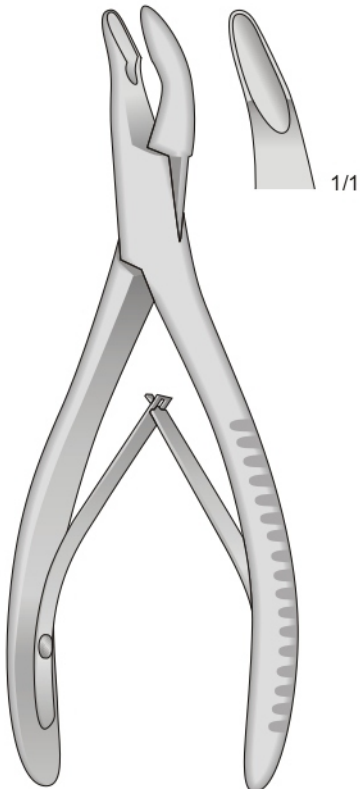

MEAD
 HS-6627
 165 mm

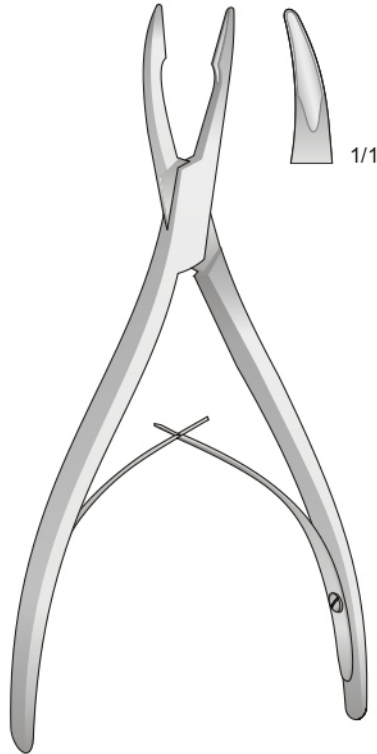

FRIEDMANN
 HS-6628
 160 mm

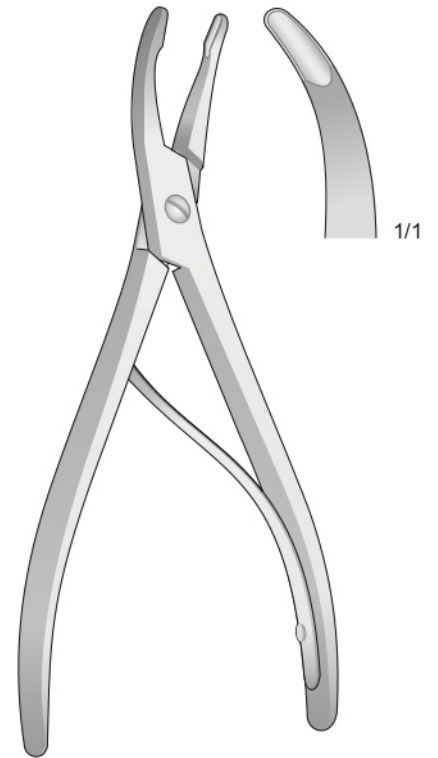

LUER
 HS-6629
 155 mm

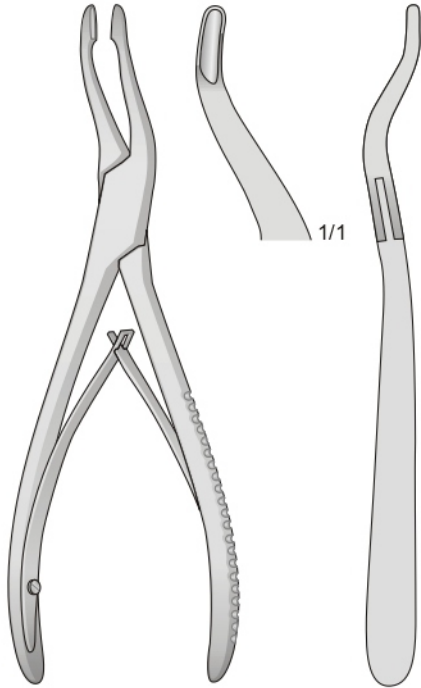

ALEXANDER
 HS-6630
 140 mm

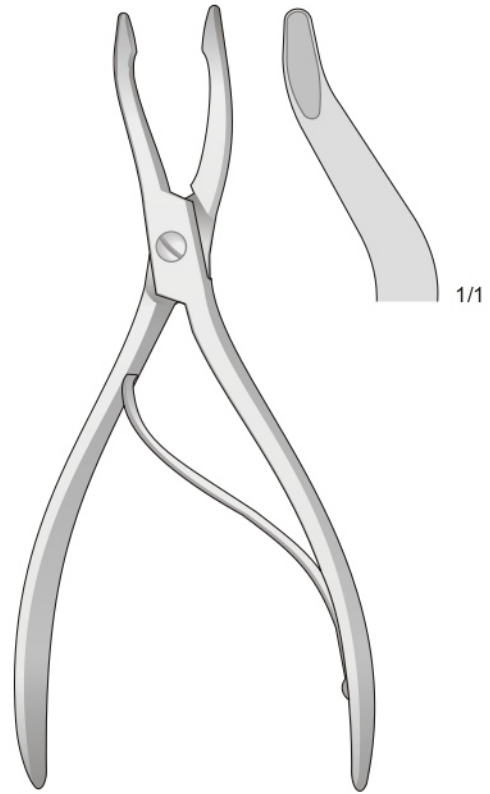

JANSEN-LEUER
 HS-6631
 180 mm

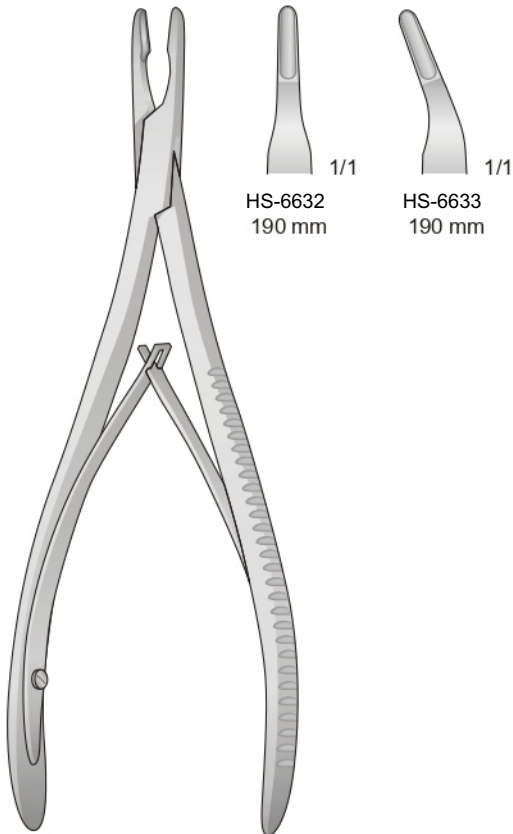

LEMPERT
 HS-6632
 190 mm

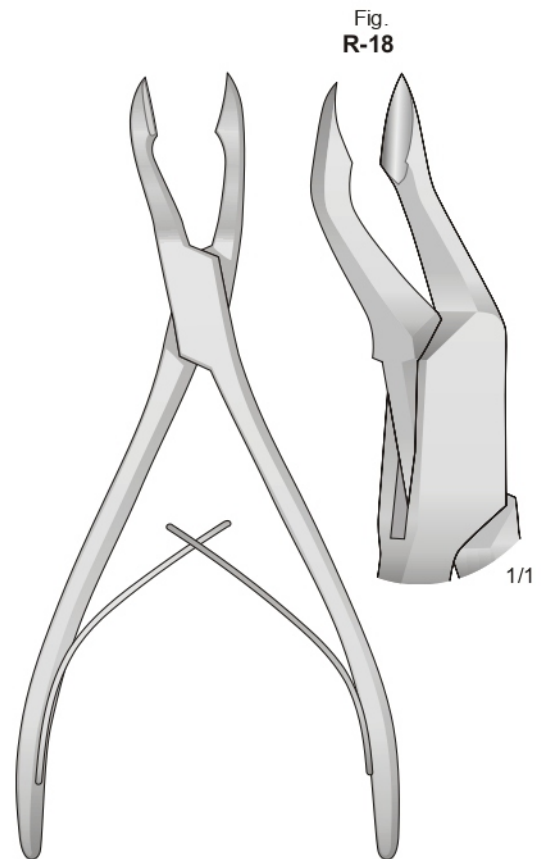

HS-6634
 175 mm

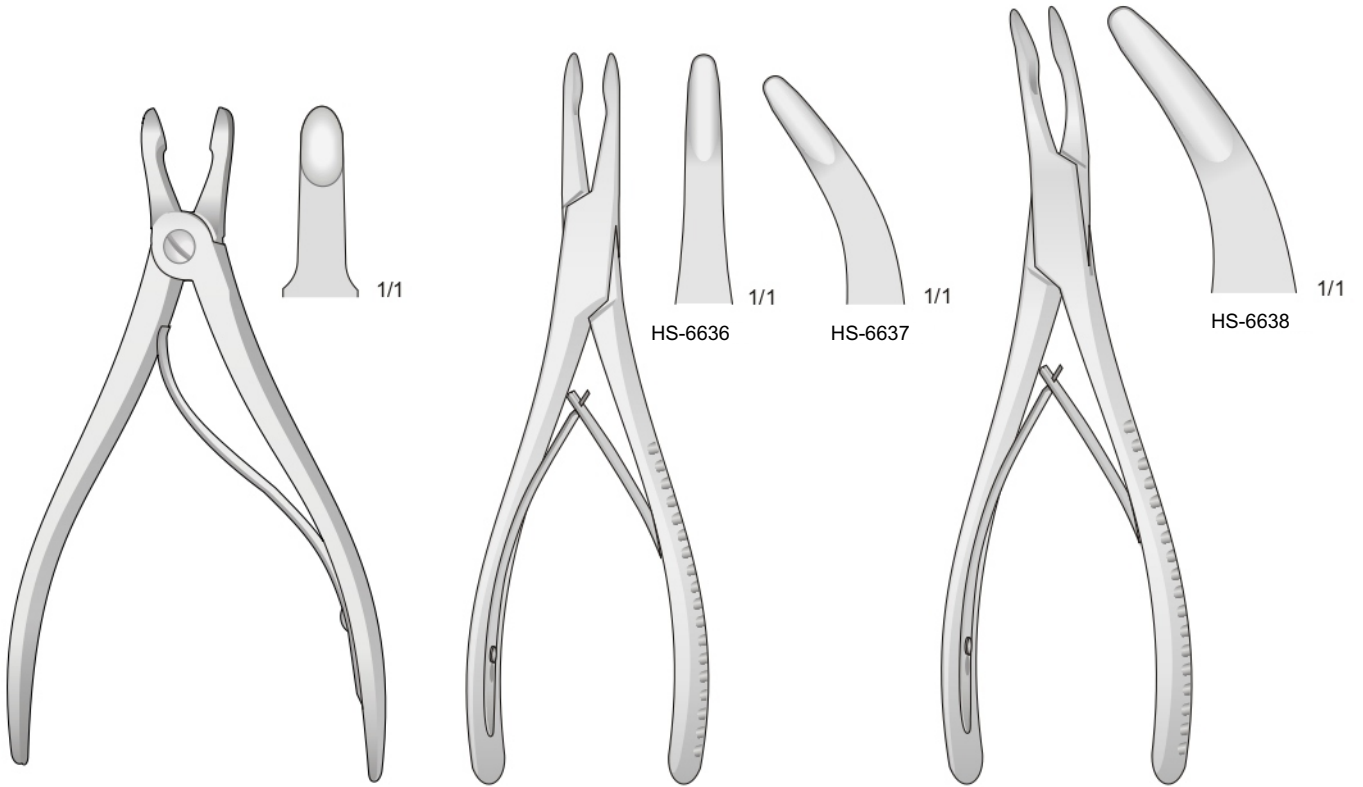

HARTMANN
HS-6635
155 mm

JANSEN
HS-6636
170 mm

OLIVECRONA
HS-6638
190 mm

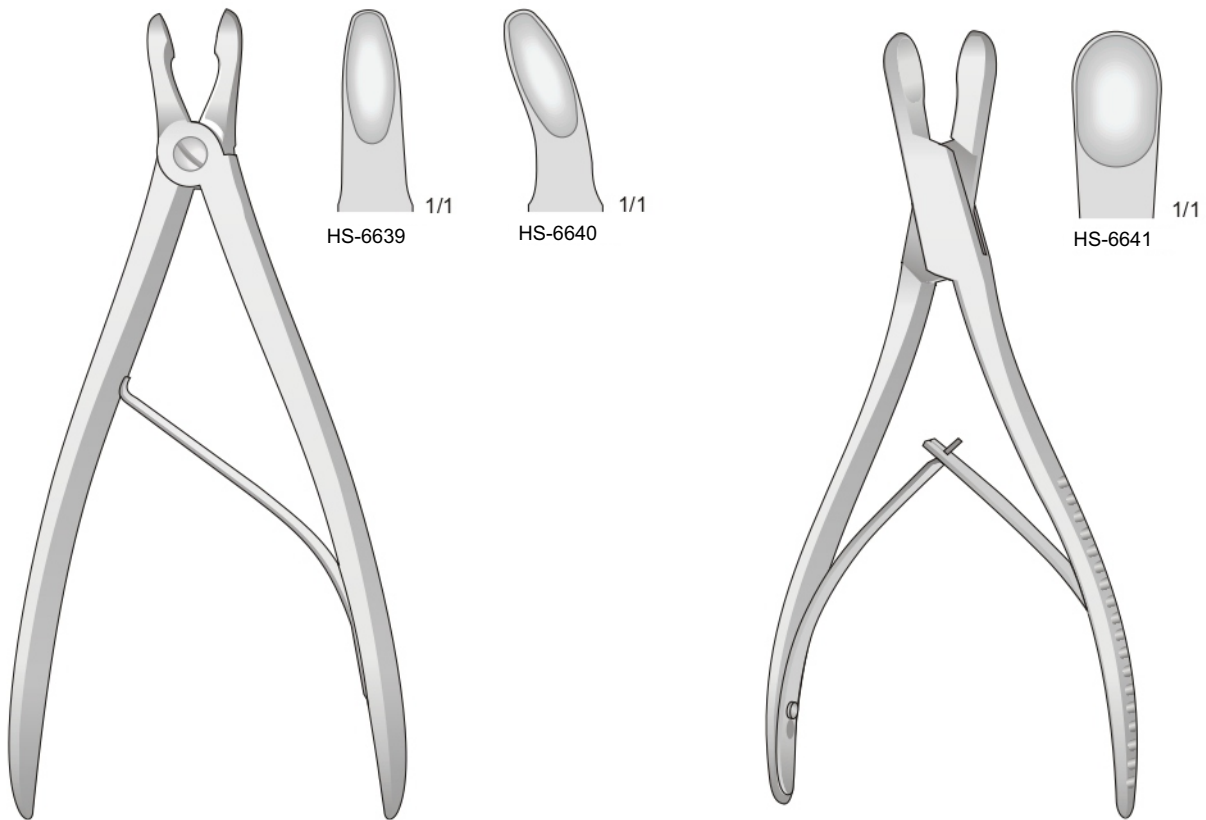

CUSHING
HS-6639
190 mm

LUER-STILLE
HS-6641
185 mm

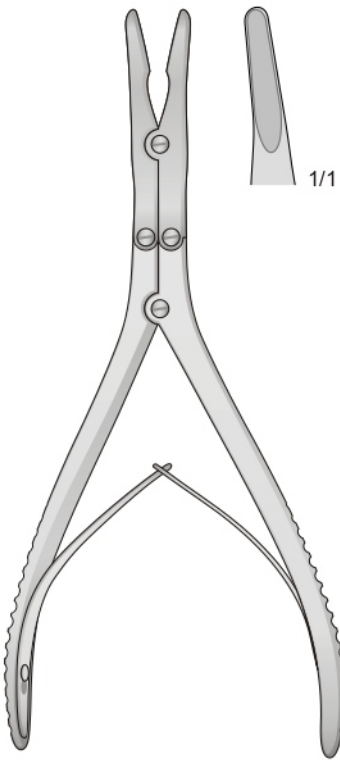

BEYER
HS-6642
180 mm

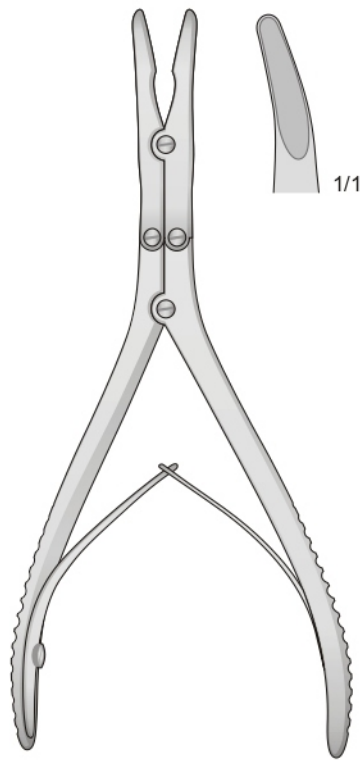

ZAUFAL-JANSEN
HS-6643
180 mm

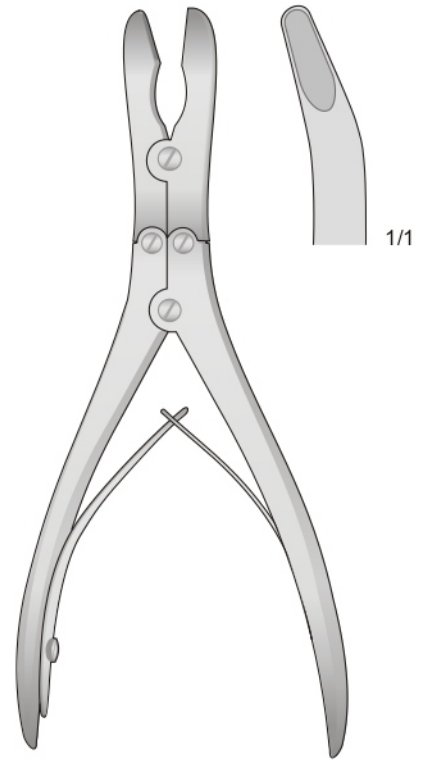

RUSKIN-STILLE
HS-6644
180 mm

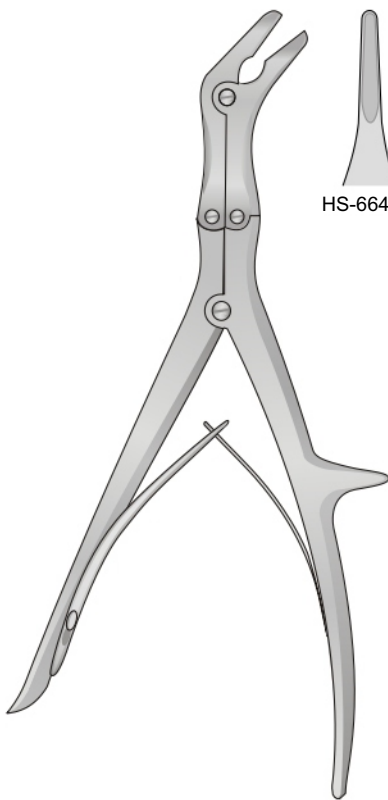

ECHLIN
HS-6645
230 mm

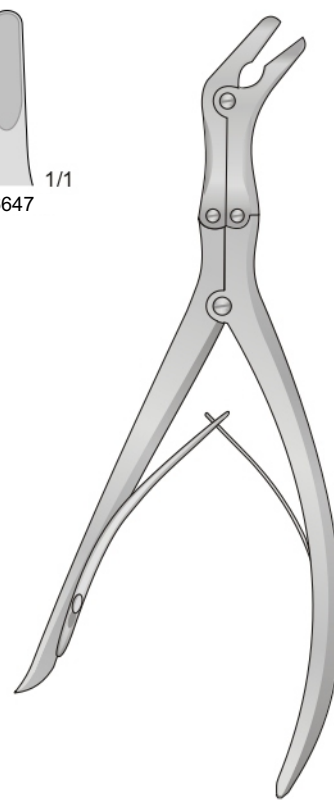
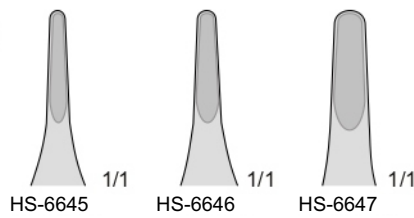

LEKSELL
HS-6648

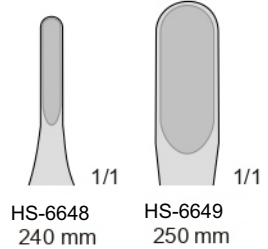

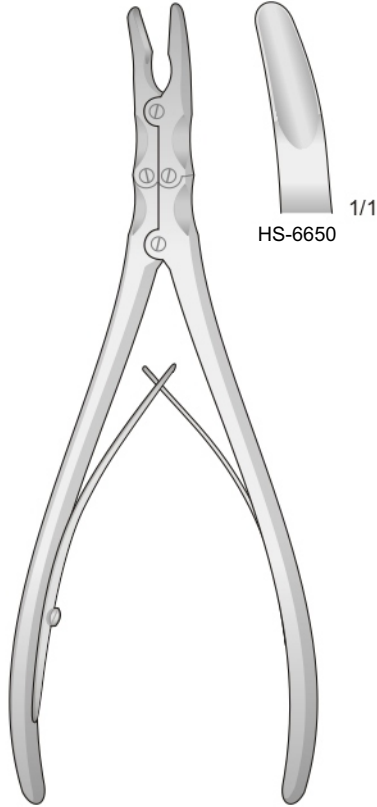

RÖTTGEN-RUSKIN
HS-6650
240 mm

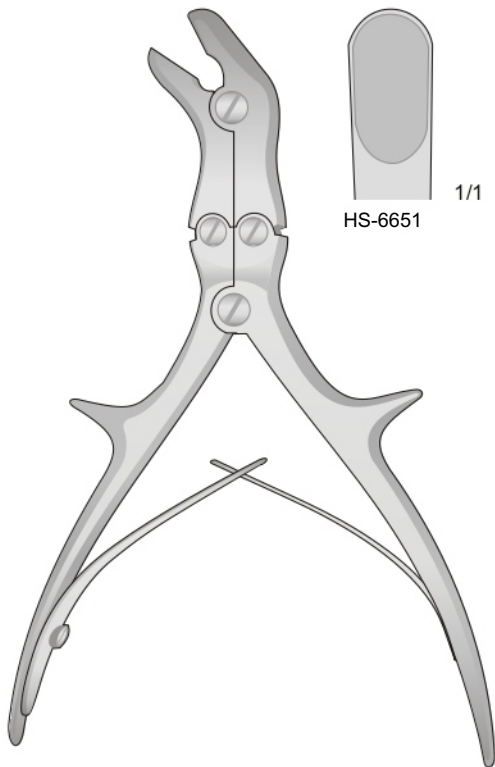

STILLE
HS-6651
210 mm

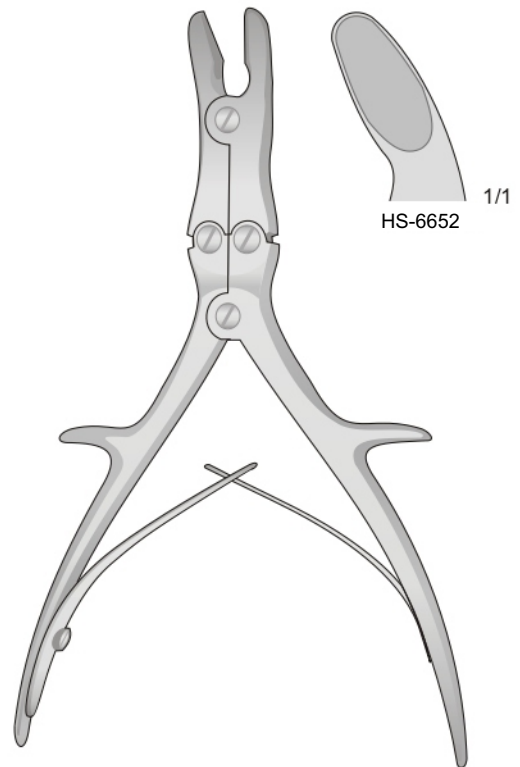

LUER-STILLE
HS-6652
210 mm

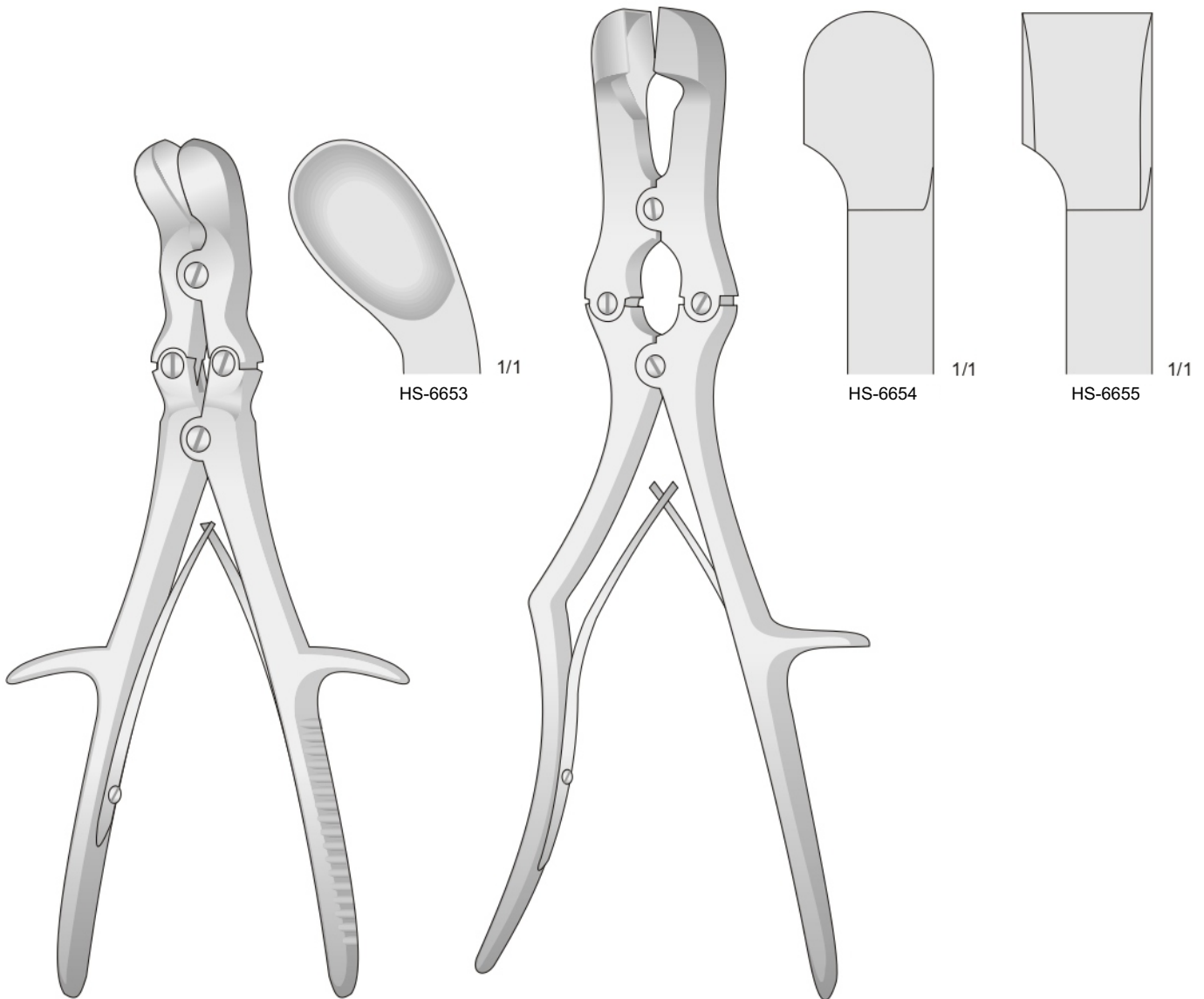

LUER-STILLE
HS-6653
260 mm

SAUERBRUCH
HS-6654
300 mm

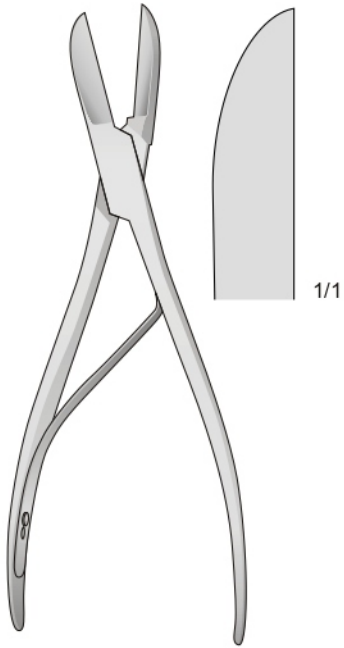

LISTON
HS-6656
220 mm

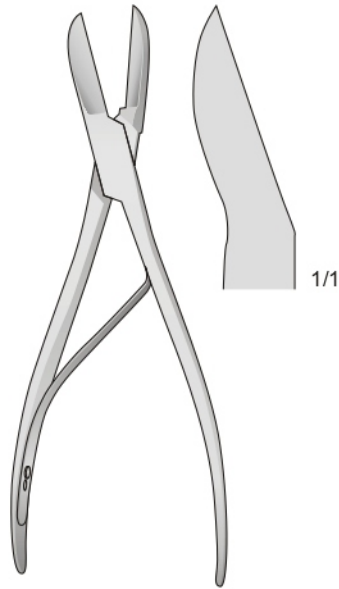

LISTON
HS-6657
170 mm

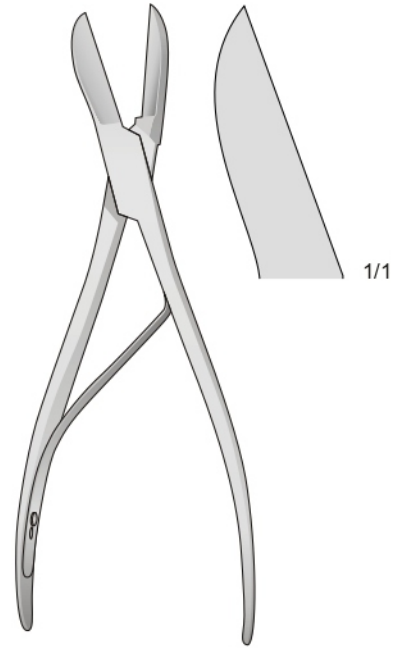

LISTON
HS-6658
220 mm

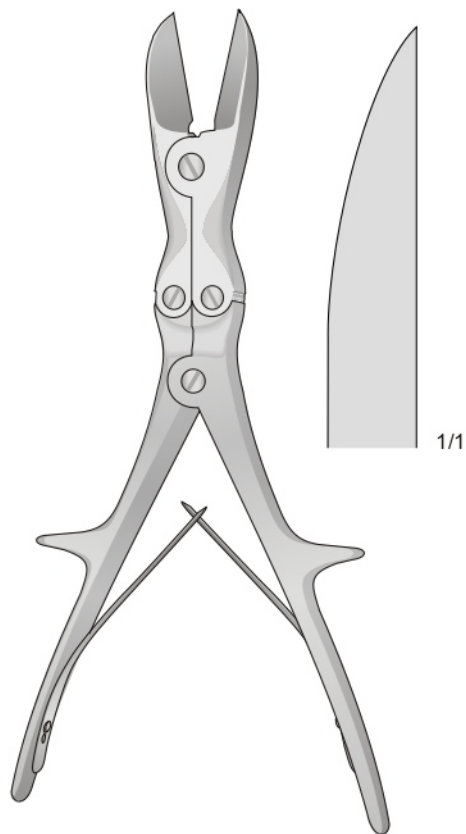

LISTON
HS-6659
270 mm

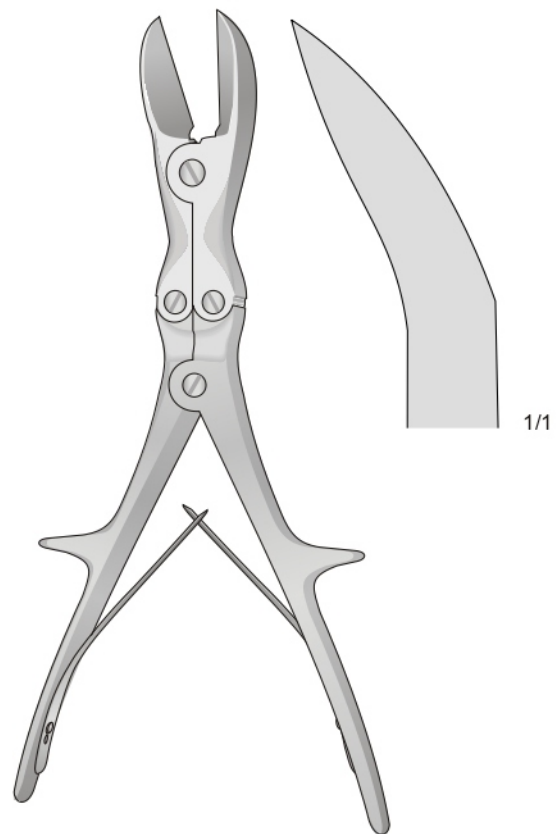

LISTON
HS-6660
270 mm

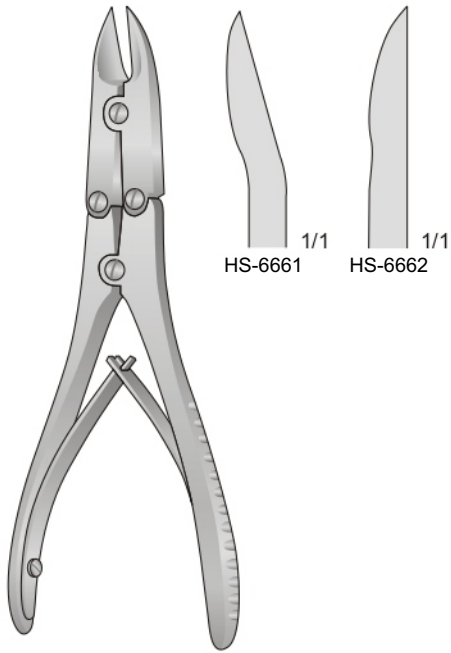

BÖHLER
HS-6661
150 mm

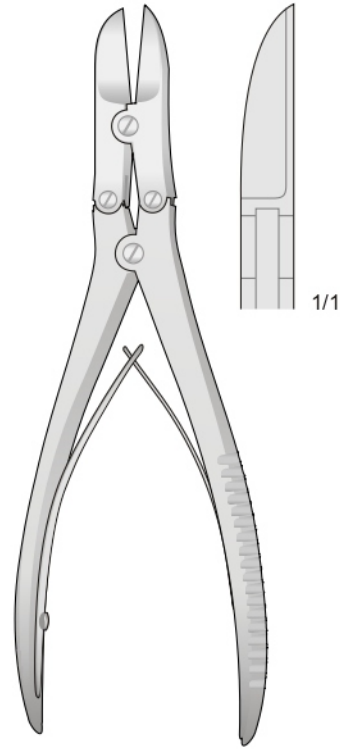

RUSKIN-LISTON
HS-6663
190 mm

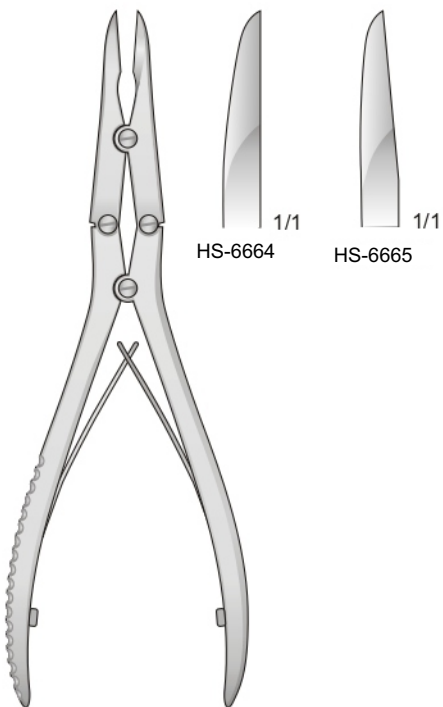

HS-6664
180 mm

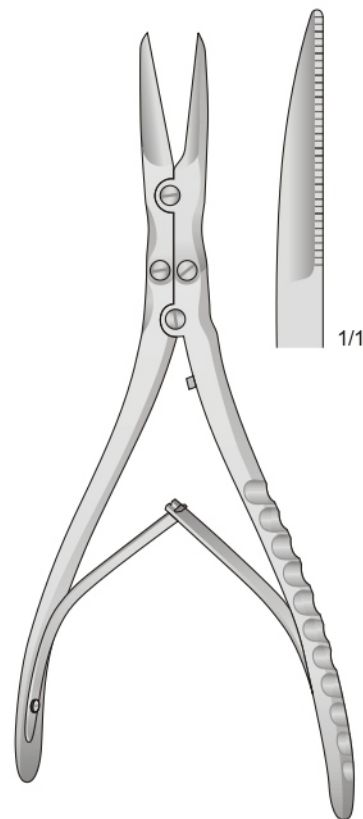

HS-6666
215 mm

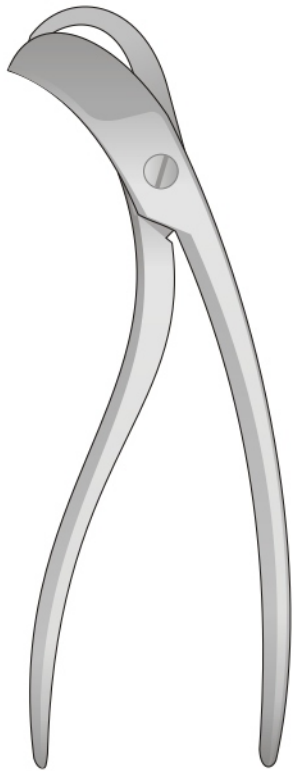

COLLIN
HS-6667
195 mm

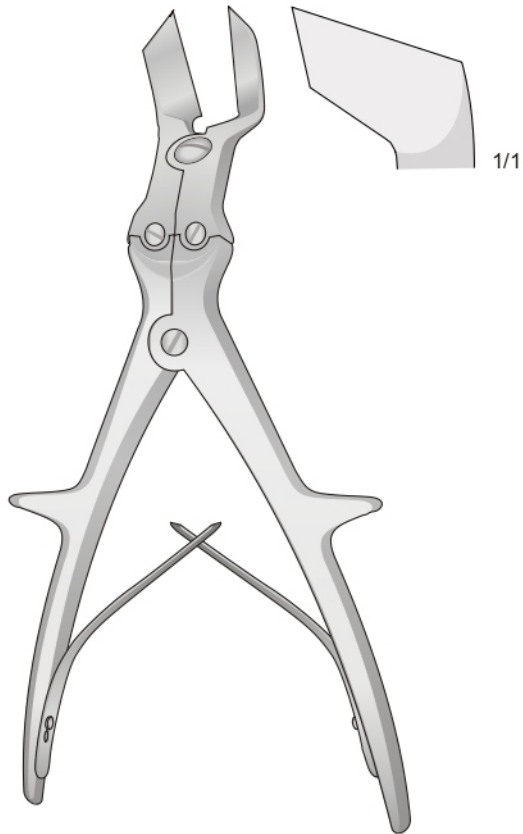

KEY-HORSLEY
HS-6668
235 mm

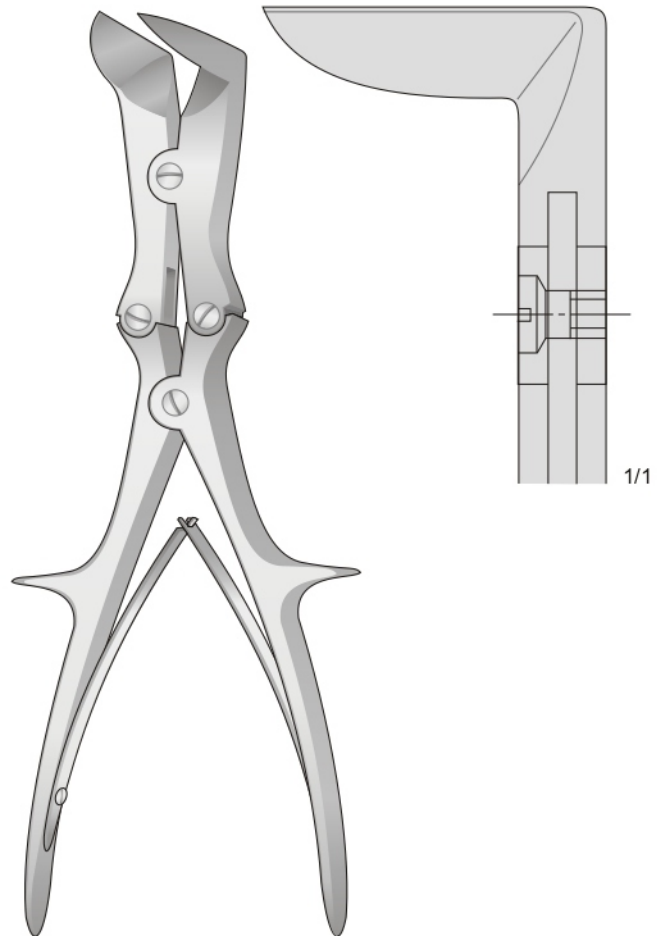

LISTON-STILLE
HS-6669
265 mm

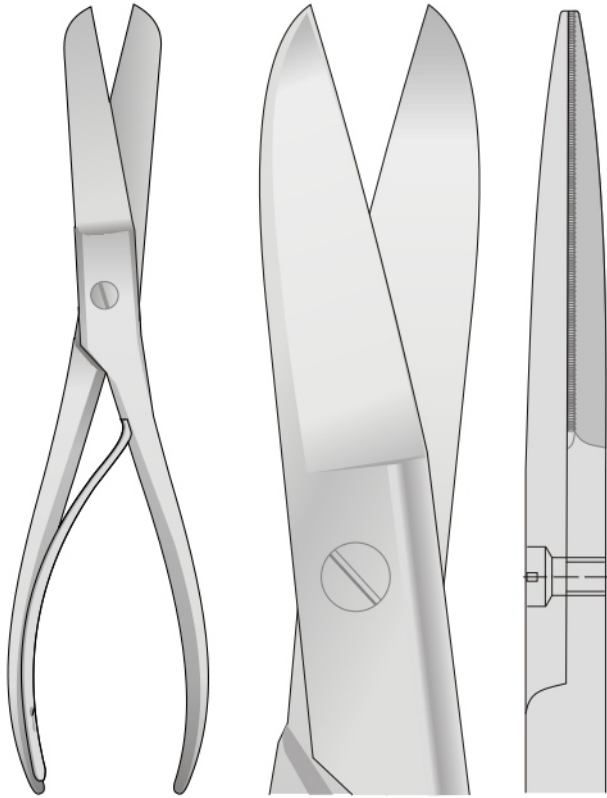

HS-6670
230 mm

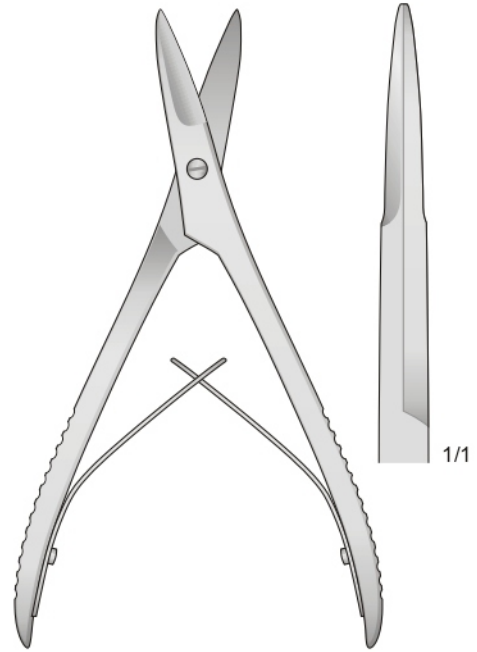

HS-6671
160 mm

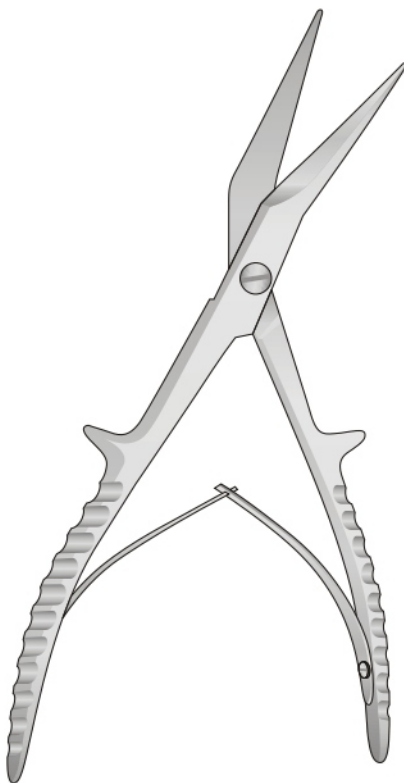

HS-6672
195 mm

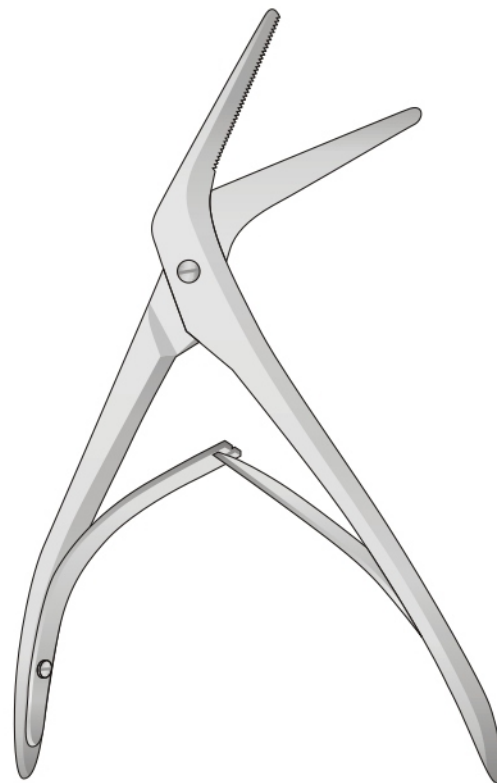

JACKSON-TESSIER
HS-6673
190 mm

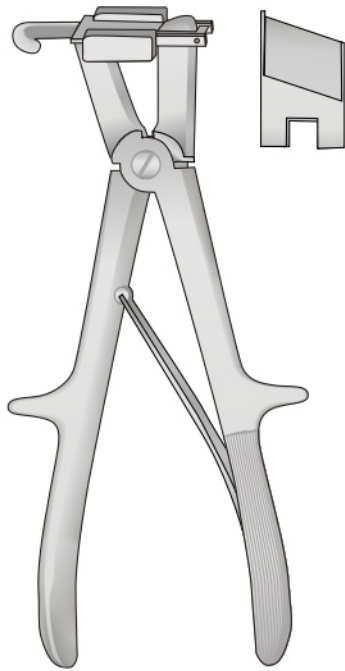

SAUERBRUCH
HS-6674 - 230 mm
HS-6675 - 260 mm

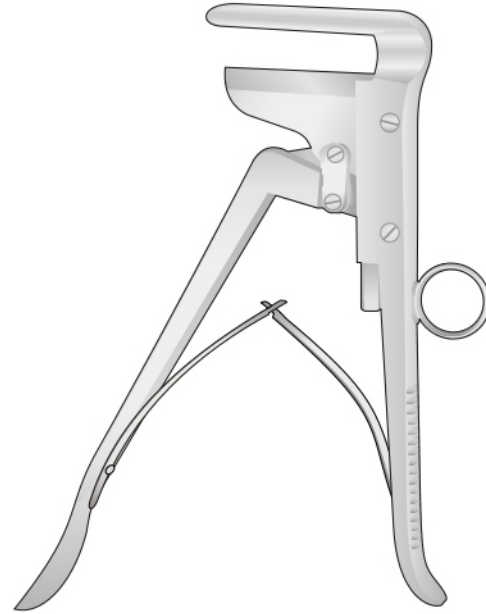

SCHUMACHER
HS-6676
210 mm

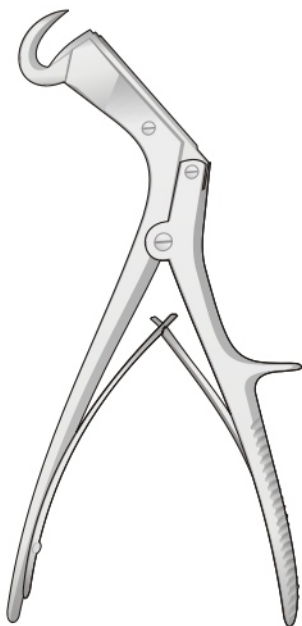

GIERTZ-STILLE
HS-6677
250 mm

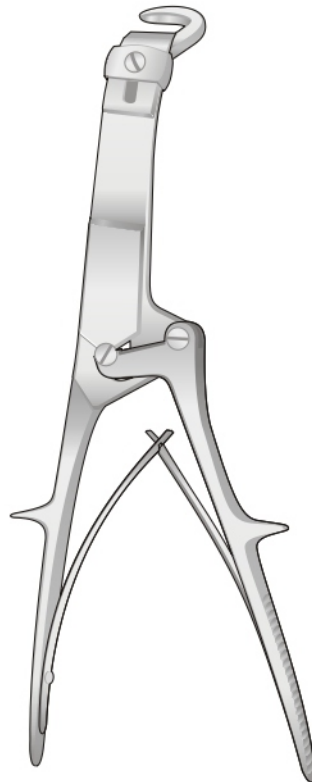

BRUNNER
HS-6678 - Destro
HS-6679 - Sinistro
320 mm

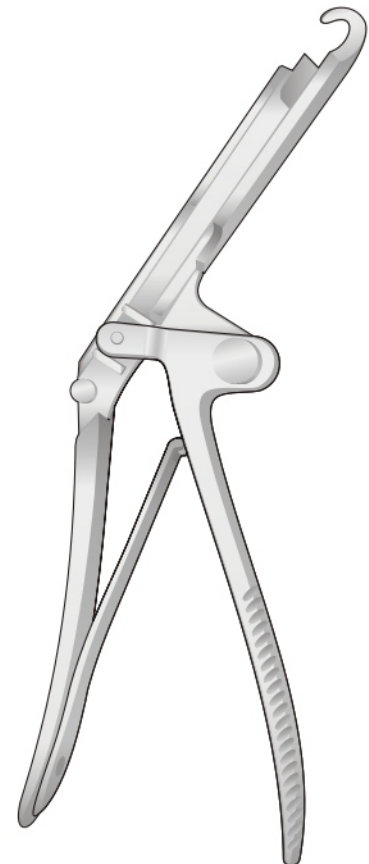

SAUERBRUCH-FREY
HS-6680
370 mm



FARABEU-F-LAMBOTTE
HS-6681
250 mm



FARABEU
HS-6682

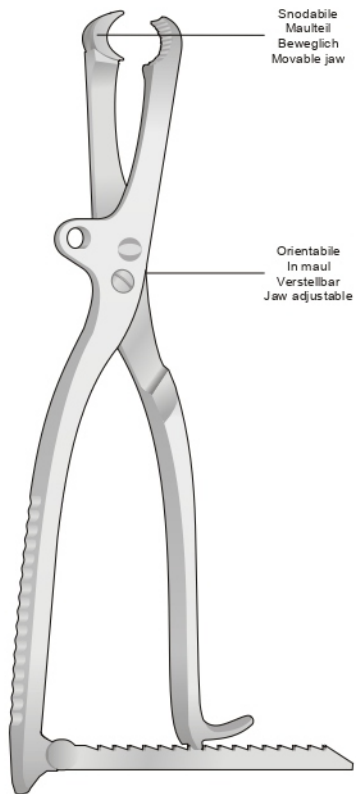

LAMBOTTE
HS-6685
265 mm

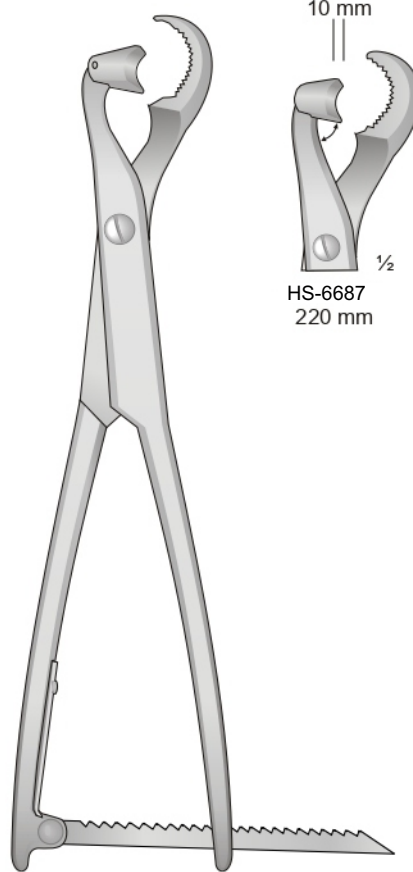

LAMBOTTE
HS-6686
330 mm

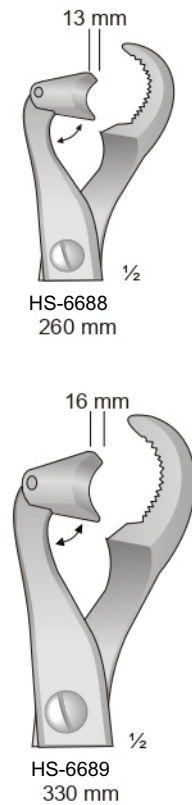

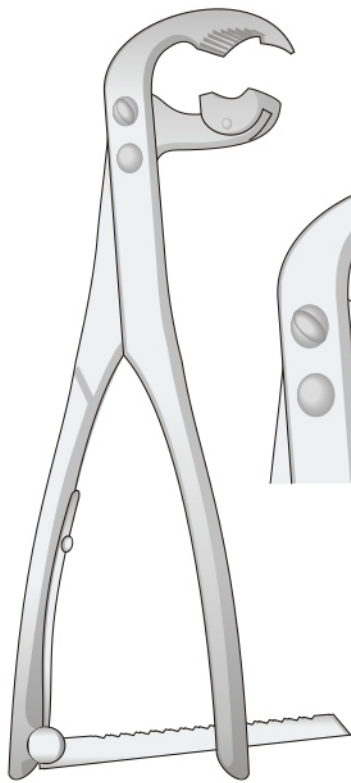

HS-6690
215 mm

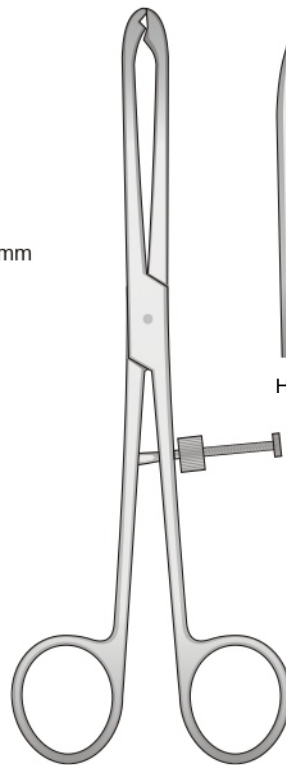
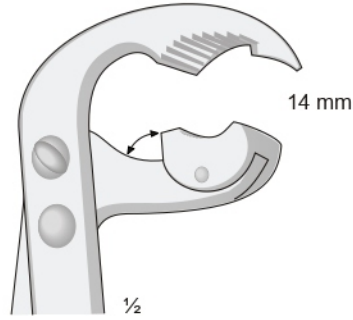

FIBULA
12-980
210 mm

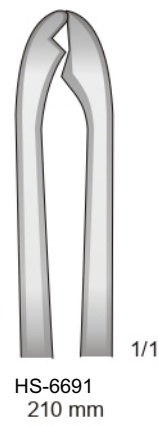

HS-6691
210 mm

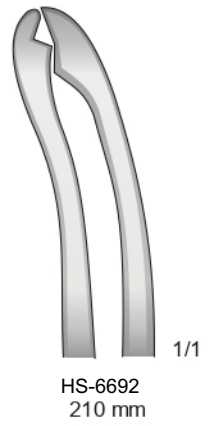

HS-6692
210 mm

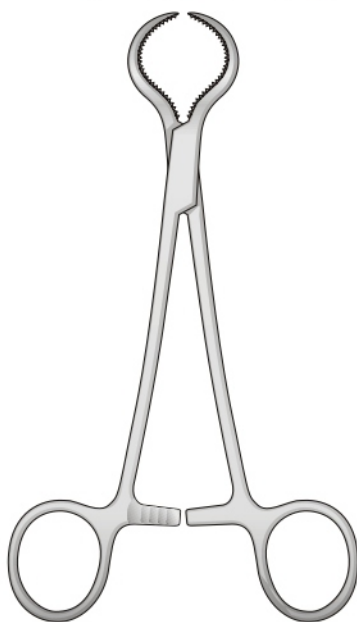

LEWIN
HS-6693
180 mm

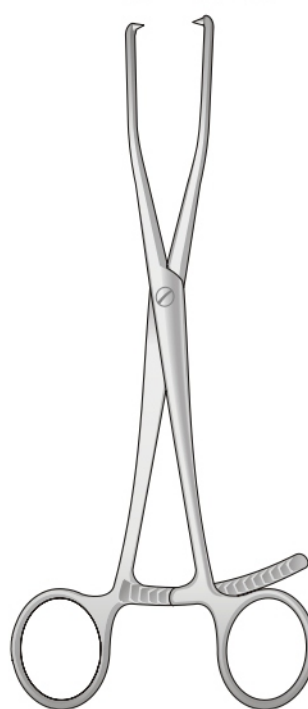

HS-6694
210 mm

Pinze riposizionatrici di osso - Repositionszangen
Reposition forceps - Pinzas para la reducción de dedos

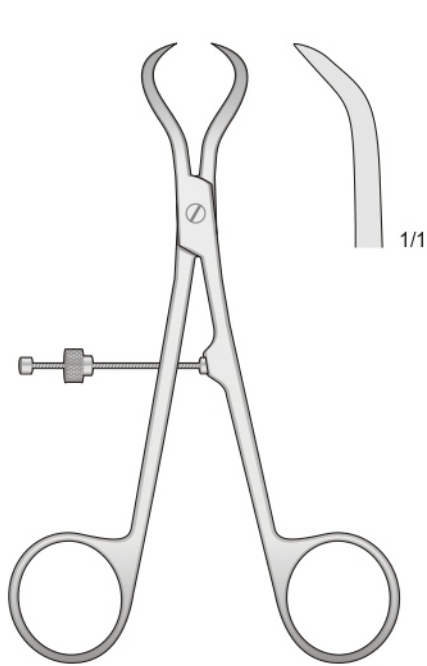

HS-6695
140 mm

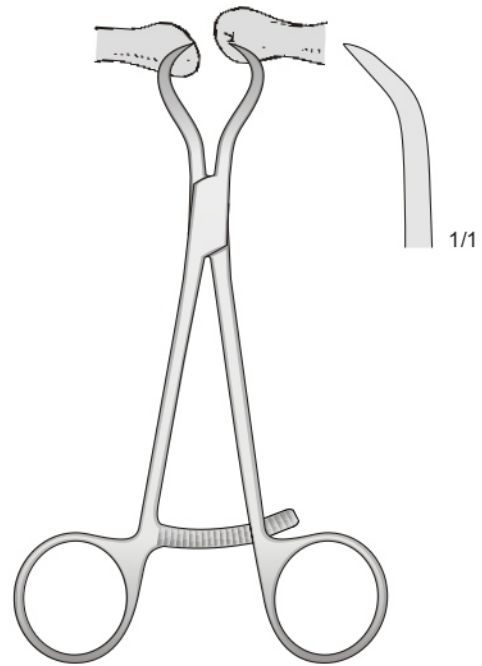

HS-6696
135 mm

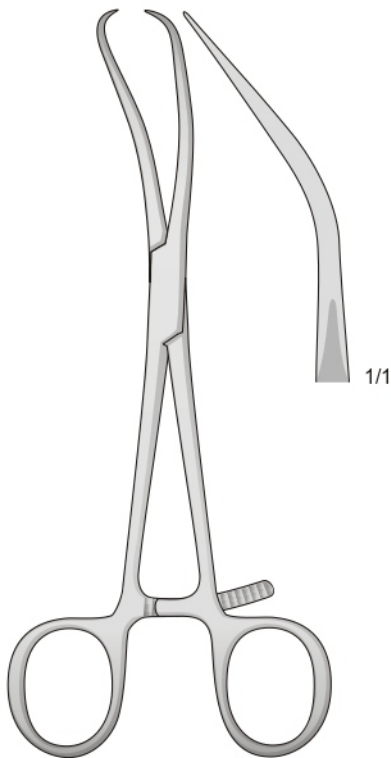

REILL
HS-6697
170 mm

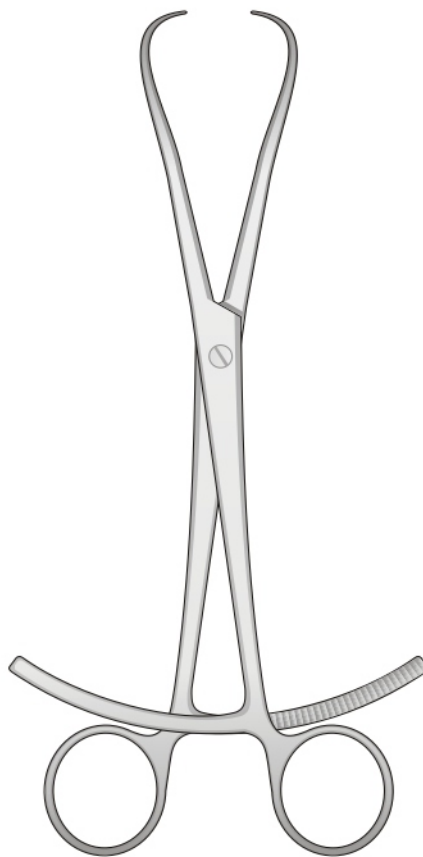

HS-6698
200 mm

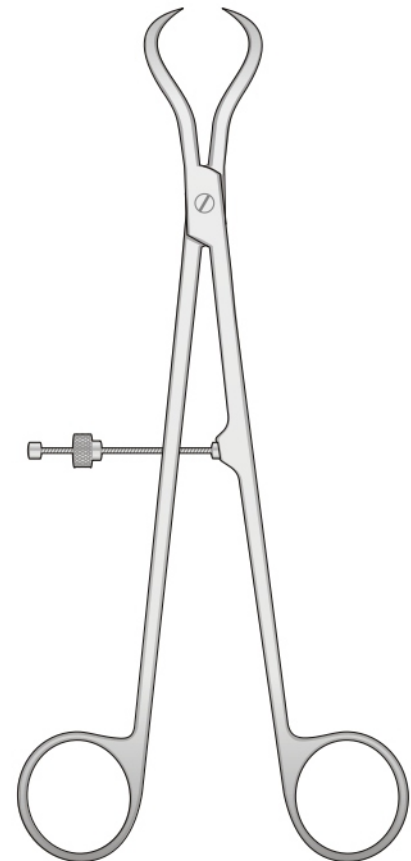

HS-6699
210 mm

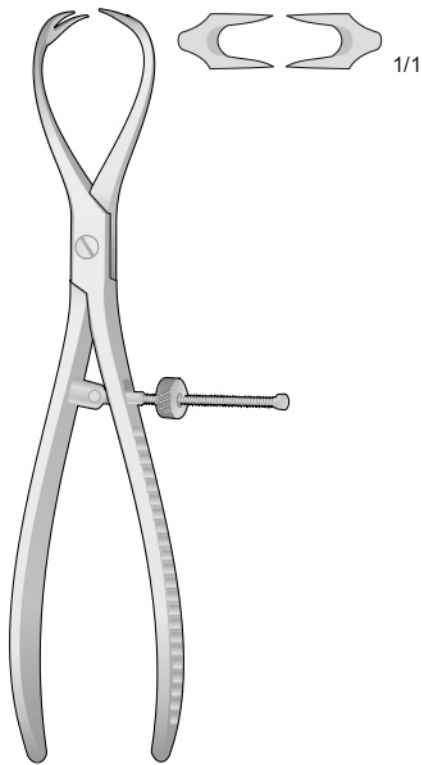

PATELLA
HS-6700
185 mm

Pinza con regolazione
Forceps with thread fixation

Pinza con regolazione
Forceps with thread fixation

Pinza con cremagliera
Forceps with ratchet fixation

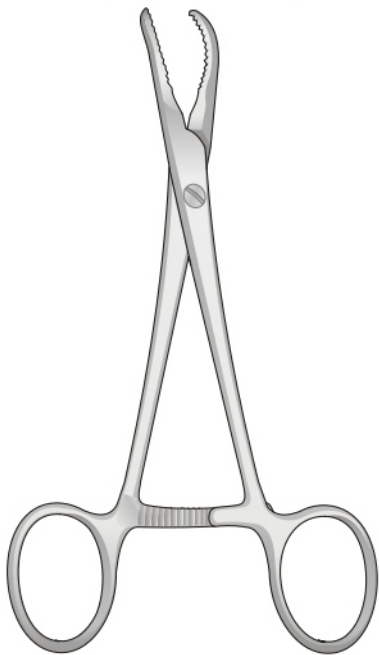

HS-6701
140 mm

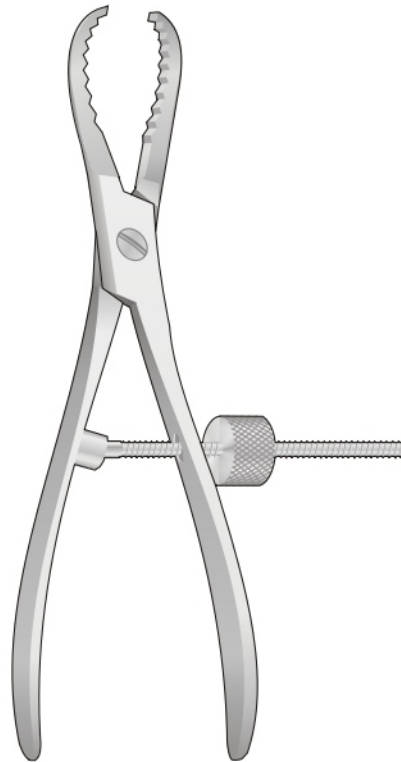

HS-6702
170 mm

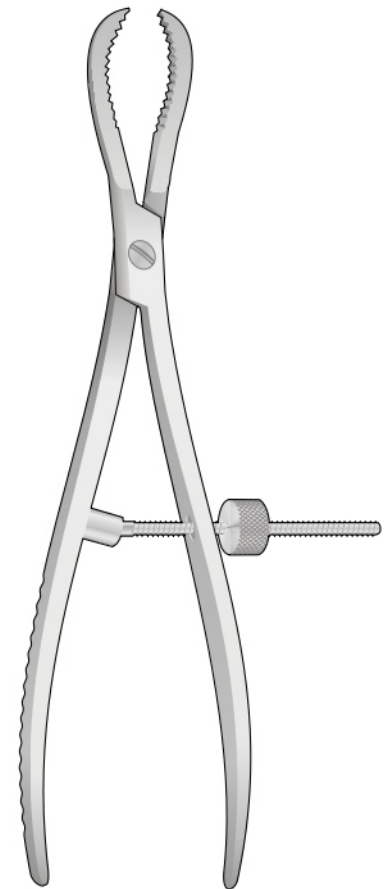

HS-6703
235 mm

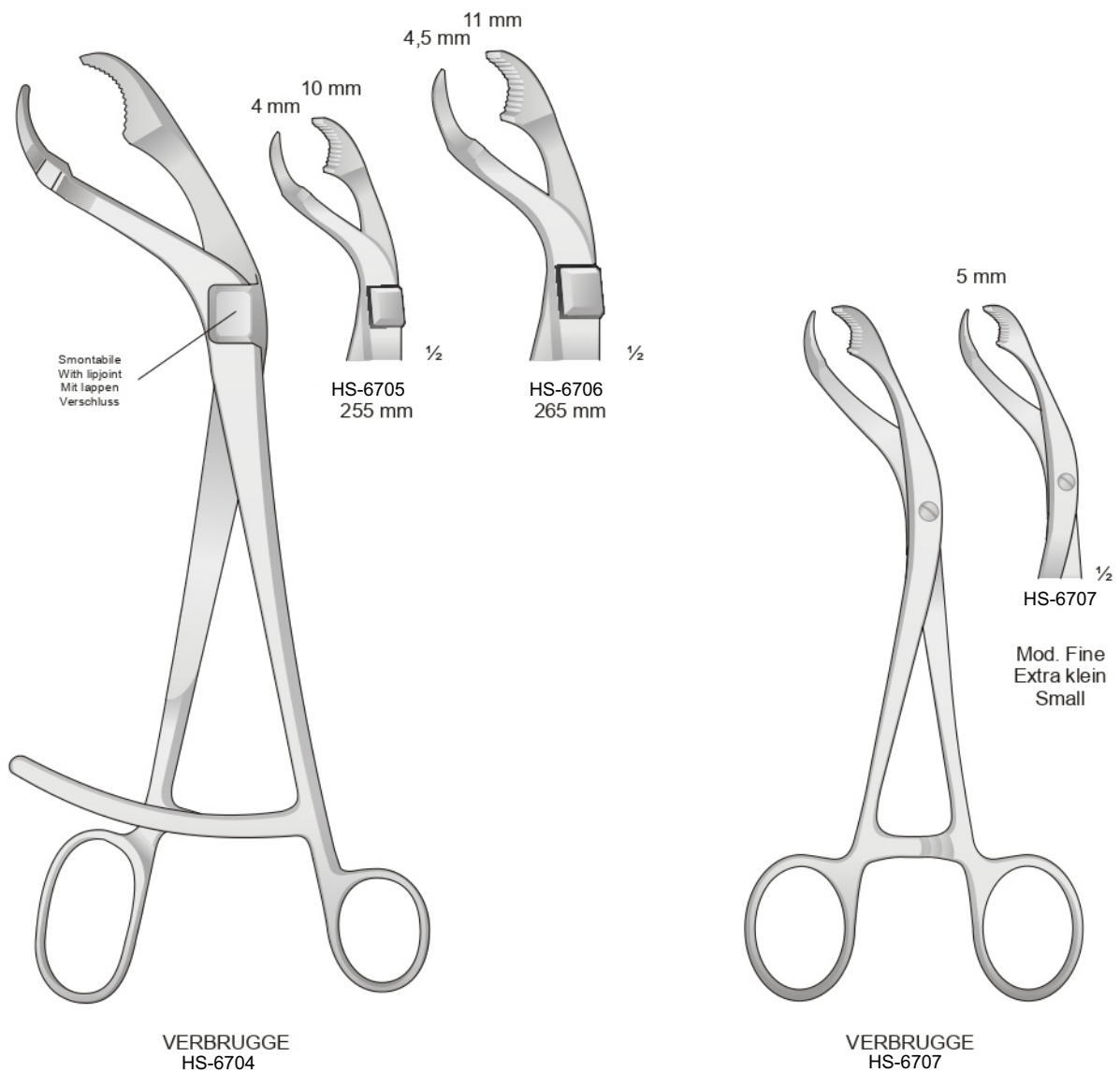

Bone Holding Forceps

Autocentrante con blocco
 Selbstzentrierend mit gewindesperre
 Self-centering bone holding forceps with thread lock

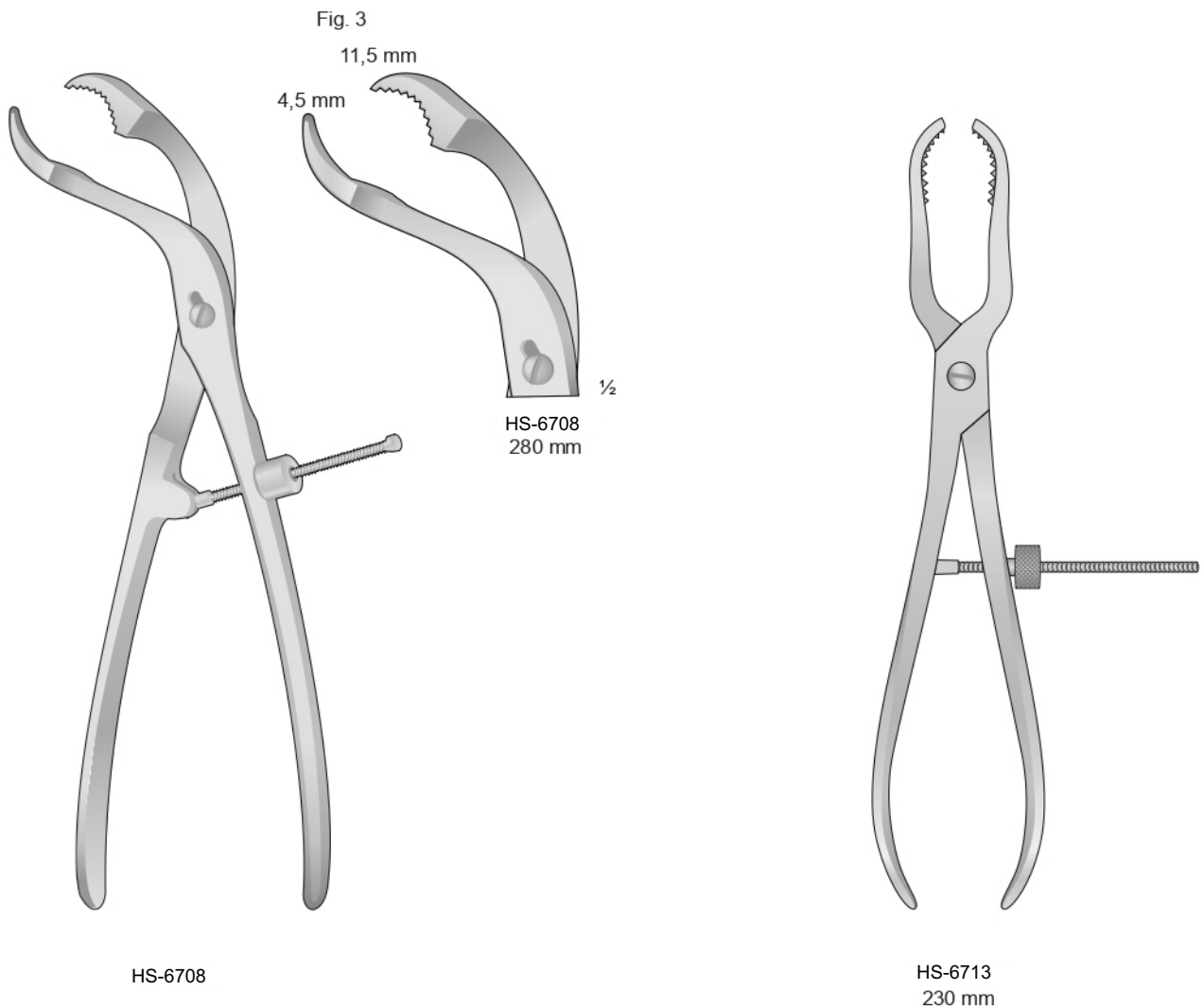
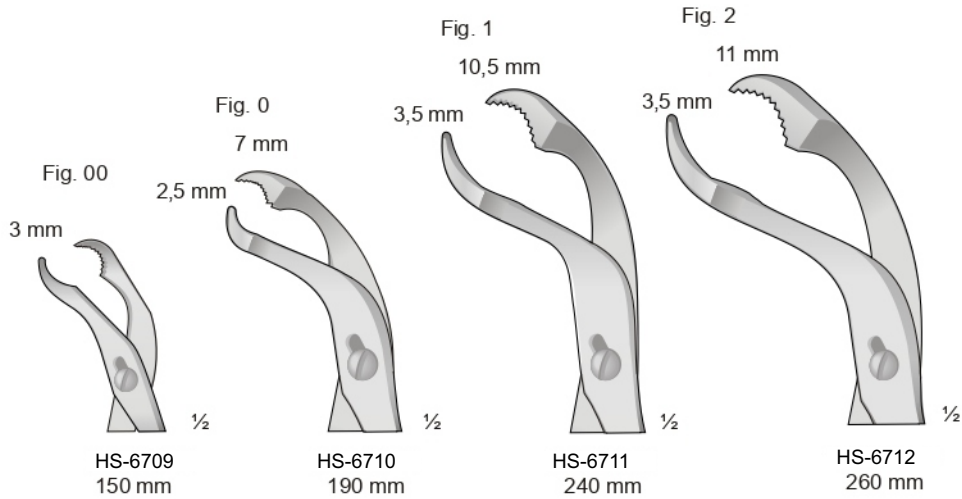

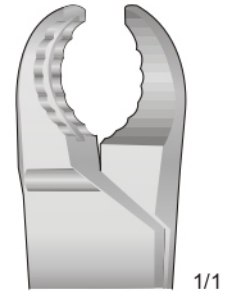

1/1

HS-6715
230 mm

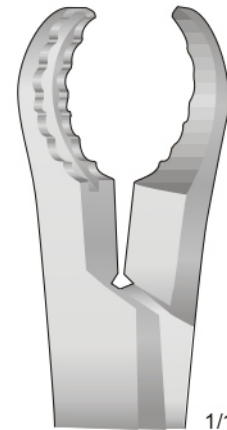

1/1

HS-6716
250 mm

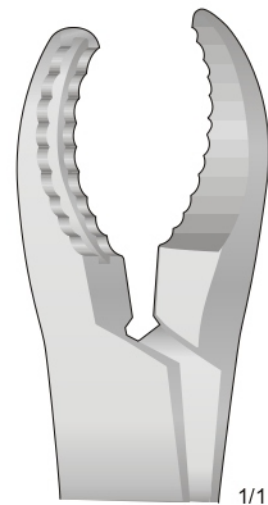

1/1

HS-6717
280 mm

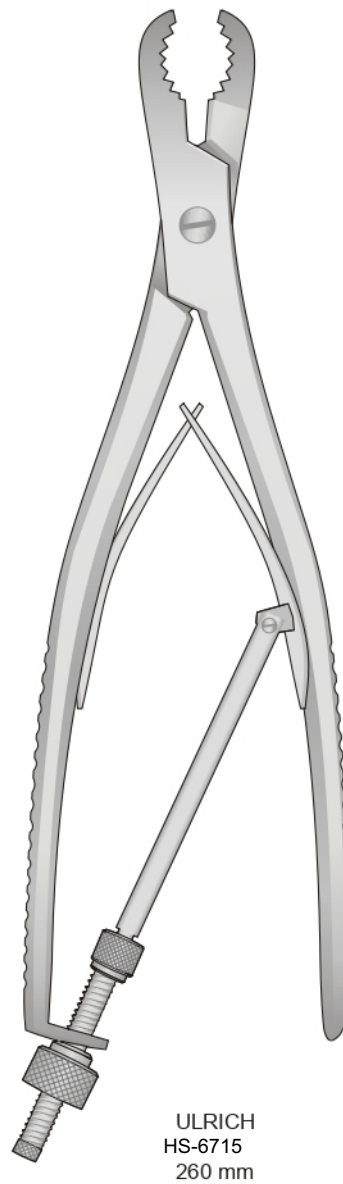
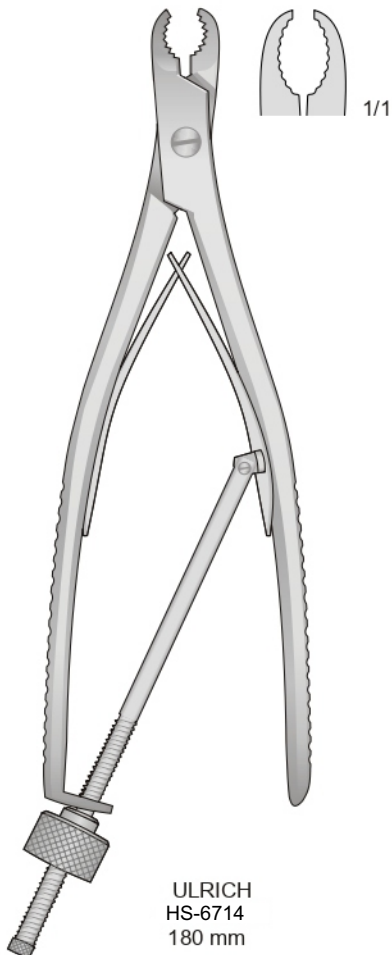



Pinza per cartilagine

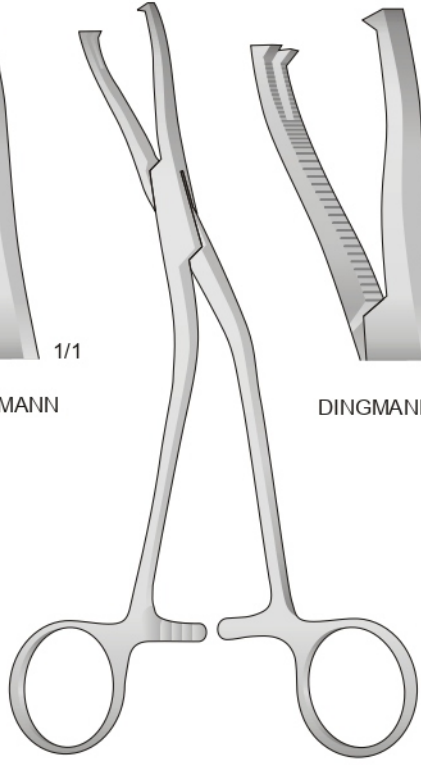
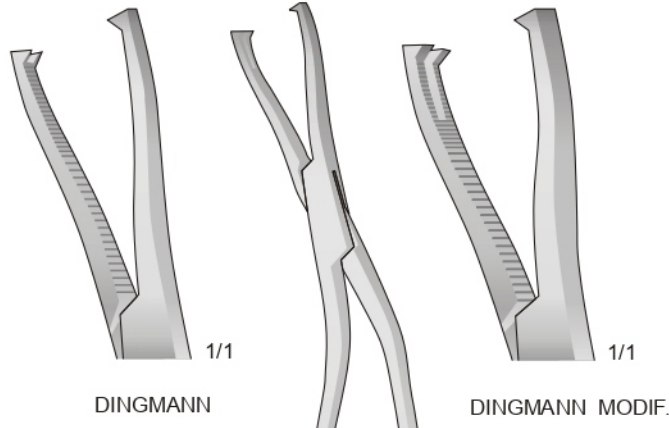

DINGMANN
12-1140
190 mm

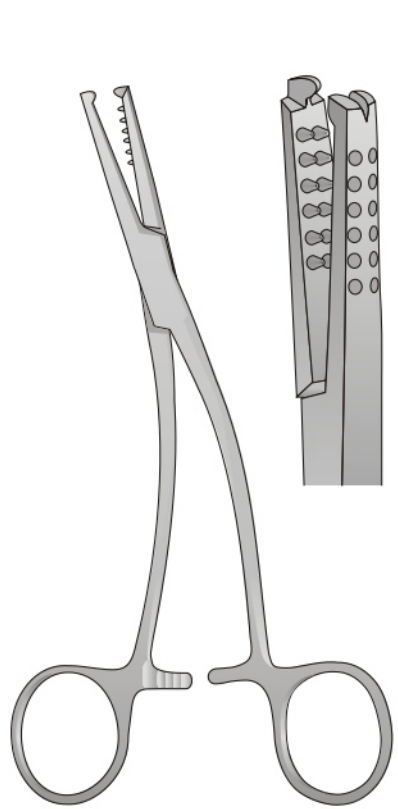

HS-6719
185 mm

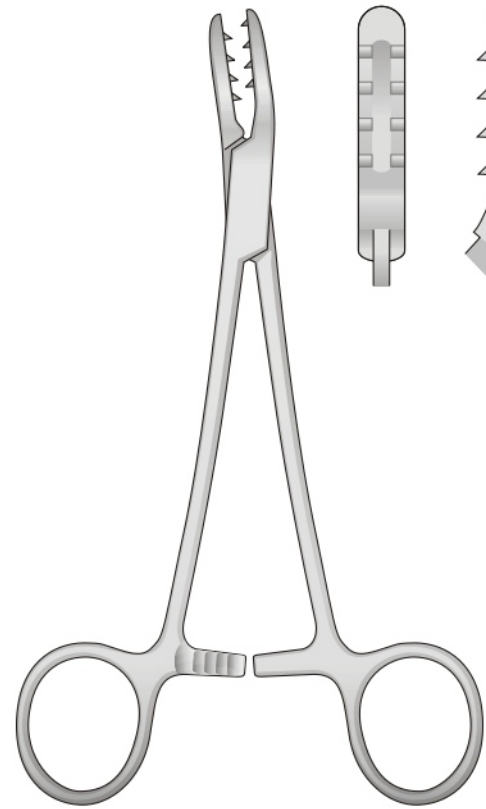
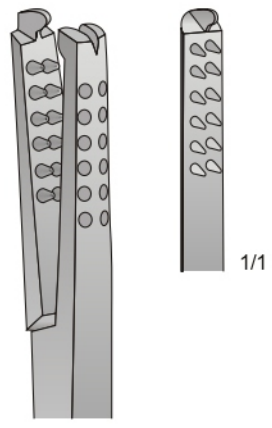

MARTIN
HS-6720
200 mm

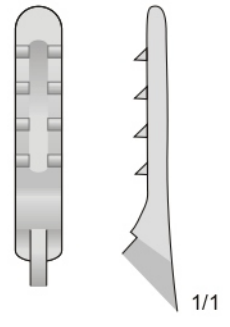

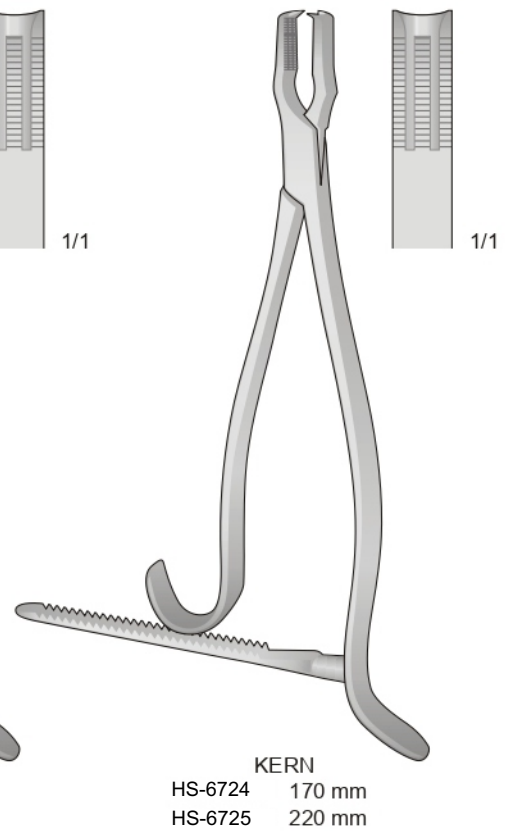
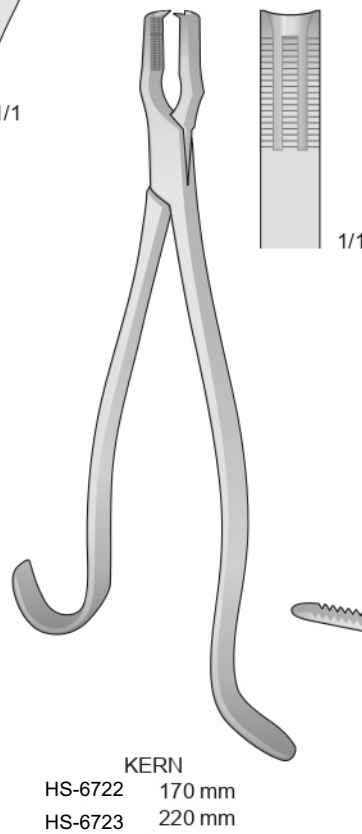
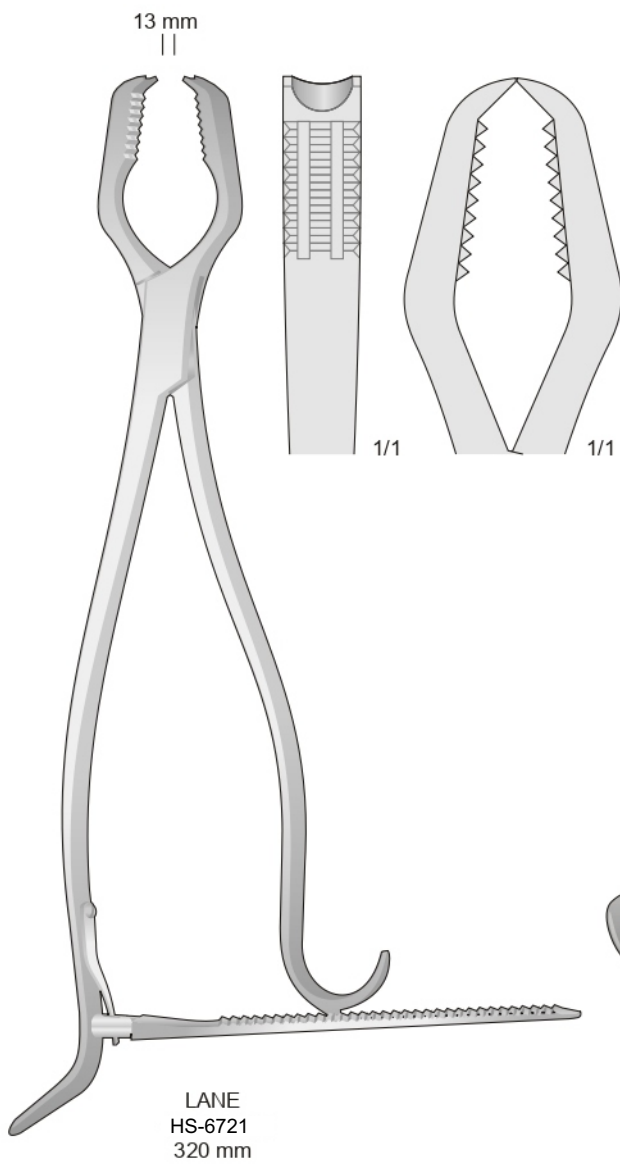

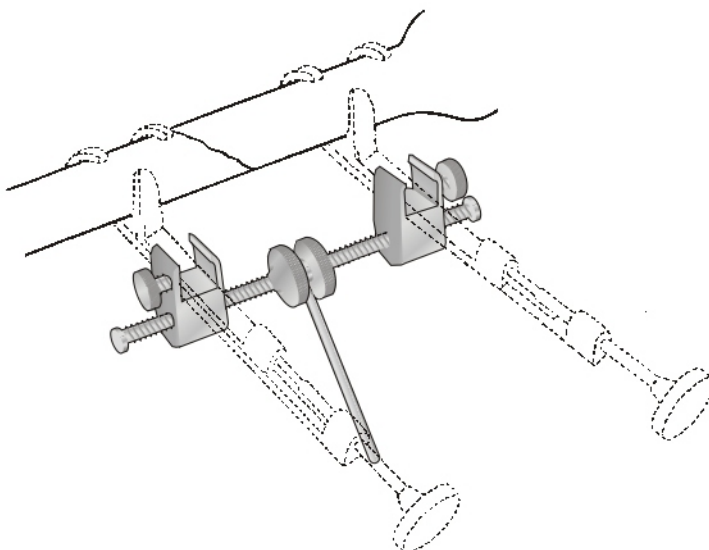

GERSTER
HS-6726

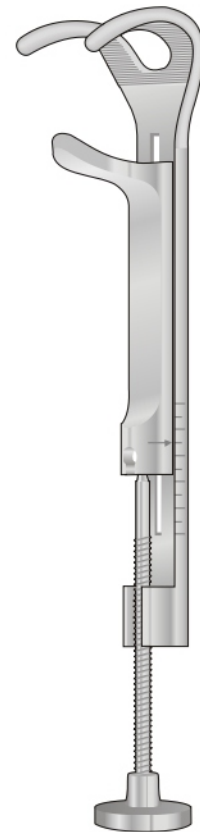

GERSTER-LOWMAN
HS-6727 120 mm
HS-6728 185 mm
HS-6729 200 mm



Per adulti - For adults - Für Erwachsene
Pour adultes - Para adultos

Per bambini
For children
Für Kinder
Pour enfants
Para niños

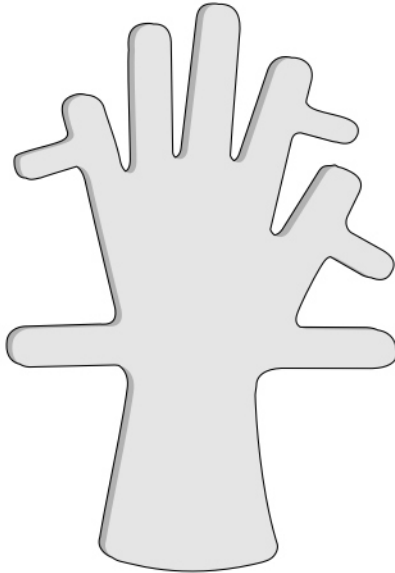

HS-6730

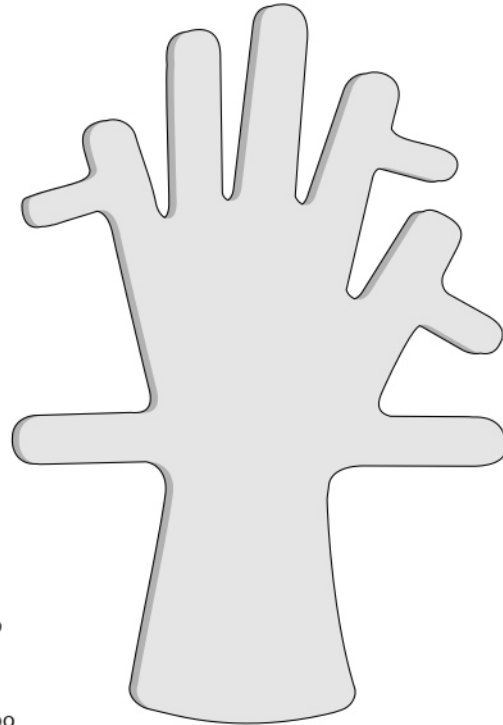

HS-6731

Mani di piombo
Lead hands
Bleihände
Main de plomb
Manos de plombo

Pinza taglia anelli - Forceps for opening rings
Fingerringssägen - Scies pour bagues - Sierra para anillos

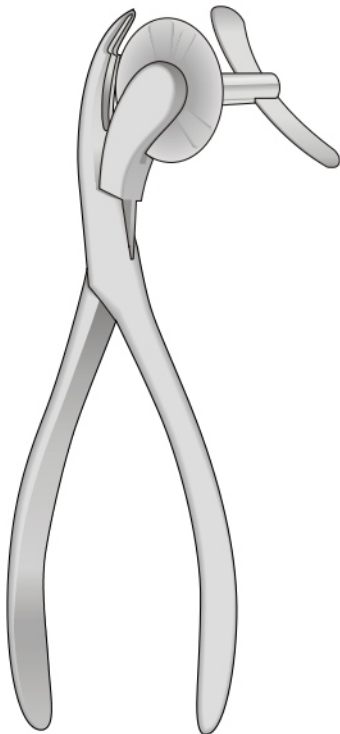

HS-6732
170 mm

Pinza per estrazione delle unghie
Nail extracting forceps
Nagel ausreißzange
Pince pour extraire les ongles
Pinzas para arrancar uñas

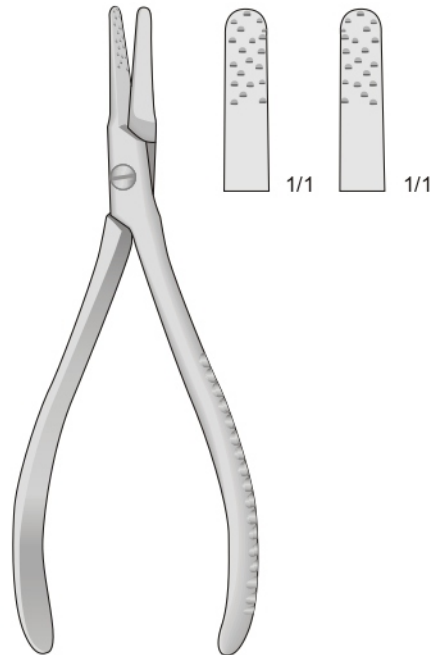

RADOLF
HS-6733
135 mm

Pinza per unghie
Nail nipper
Nagelspaltzange
Pince à ongles
Pinzas corta uñas

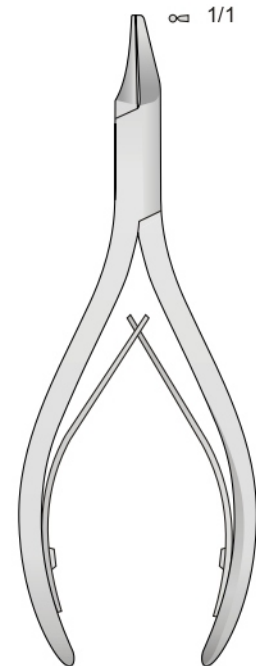

HS-6734
135 mm



OBWEGESER
HS-6735
140 mm



1/1



OBWEGESER
HS-6736
230 mm



1/1



HS-6737
180 mm



1/1

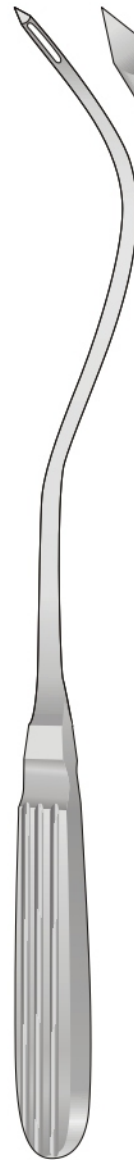

SANDERS-BROWN
HS-6738
290 mm



1/1

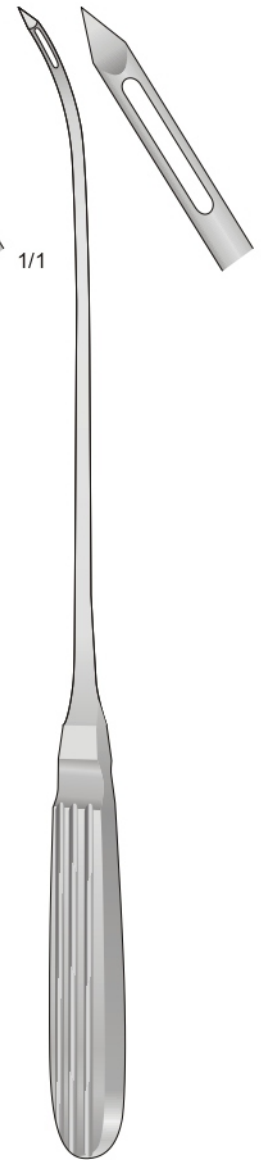

SANDERS-BROWN
HS-6739
300 mm



1/1

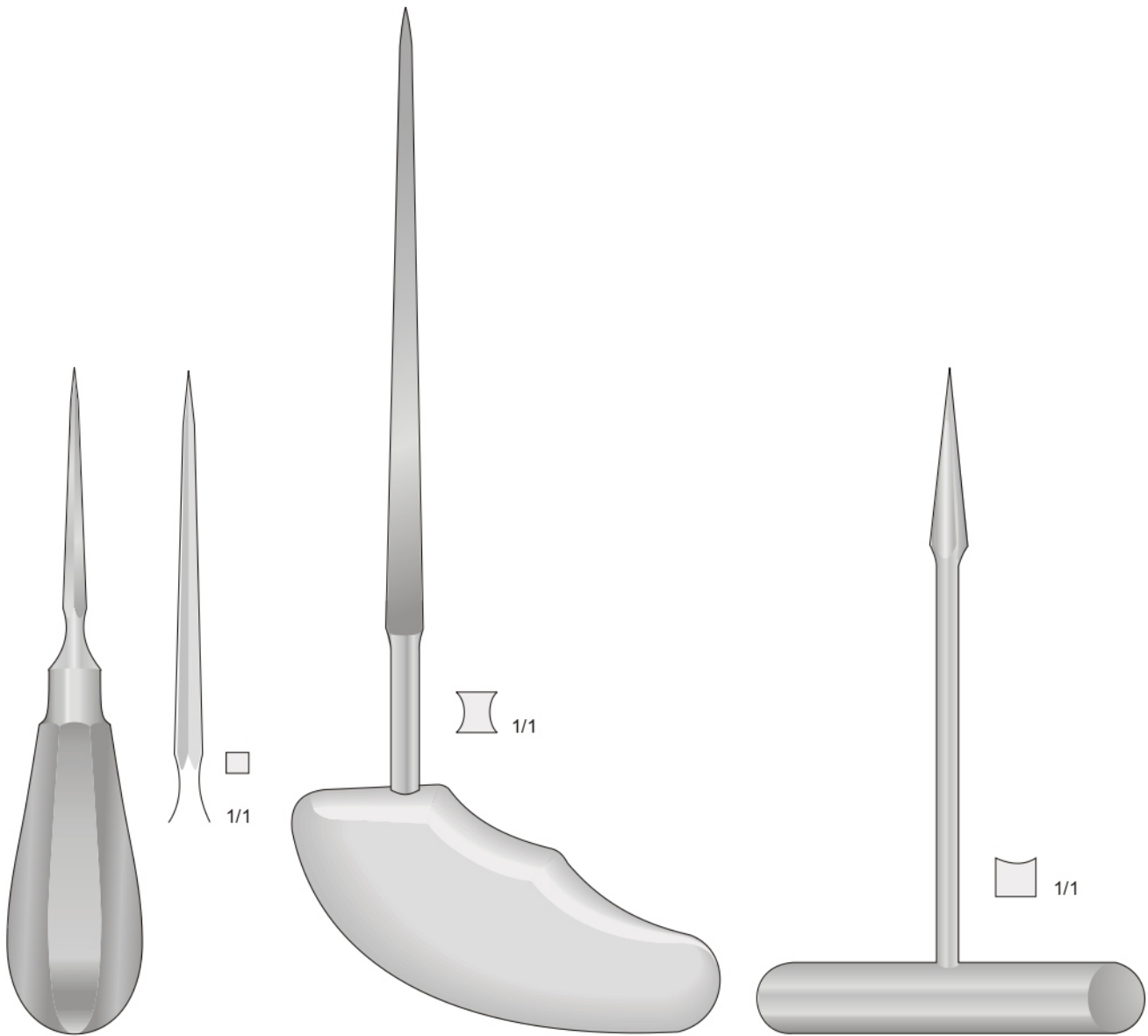





HS-6740
140 mm

PERTHES
HS-6741
210 mm

HS-6742
140 mm

Punche da biopsia - Hautstanzen
Dermal punches - Trépanos cutáneos



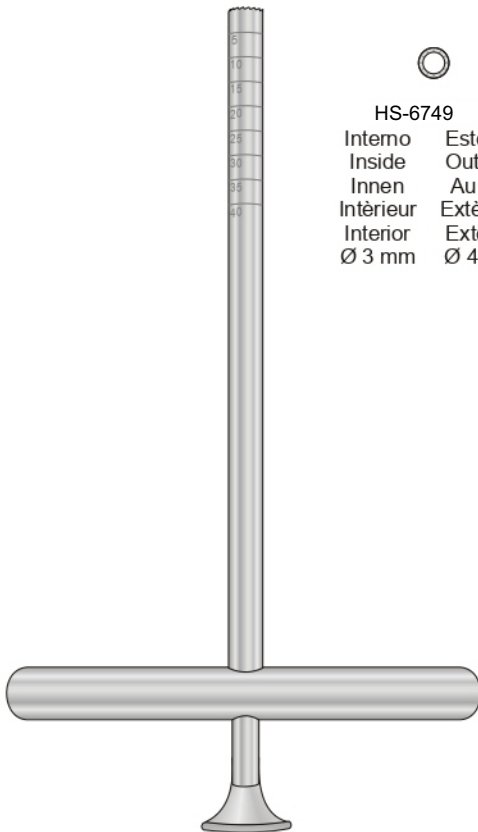

- 
 HS-6744
3 mm
- 
 HS-6745
4 mm
- 
 HS-6746
5 mm
- 
 HS-6747
6 mm

KEYES
HS-6743
100 mm



HS-6748
170 mm

- | | | | | | |
|---|-----------|---|-----------|---|-----------|
|  | |  | |  | |
| HS-6749 | | HS-6750 | | HS-6751 | |
| Interno | Esterno | Interno | Esterno | Interno | Esterno |
| Inside | Outside | Inside | Outside | Inside | Outside |
| Innen | Außen | Innen | Außen | Innen | Außen |
| Intérieur | Extérieur | Intérieur | Extérieur | Intérieur | Extérieur |
| Interior | Exterior | Interior | Exterior | Interior | Exterior |
| Ø 3 mm | Ø 4 mm | Ø 3,9 mm | Ø 5 mm | Ø 6,4 mm | Ø 8 mm |

12-1260-01
 Set completo di 4 pezzi
 Set complete with 4 pieces
 Komplettsset mit 4 Teilen
 Set complet avec 4 pièces
 Set completo con 4 piezas

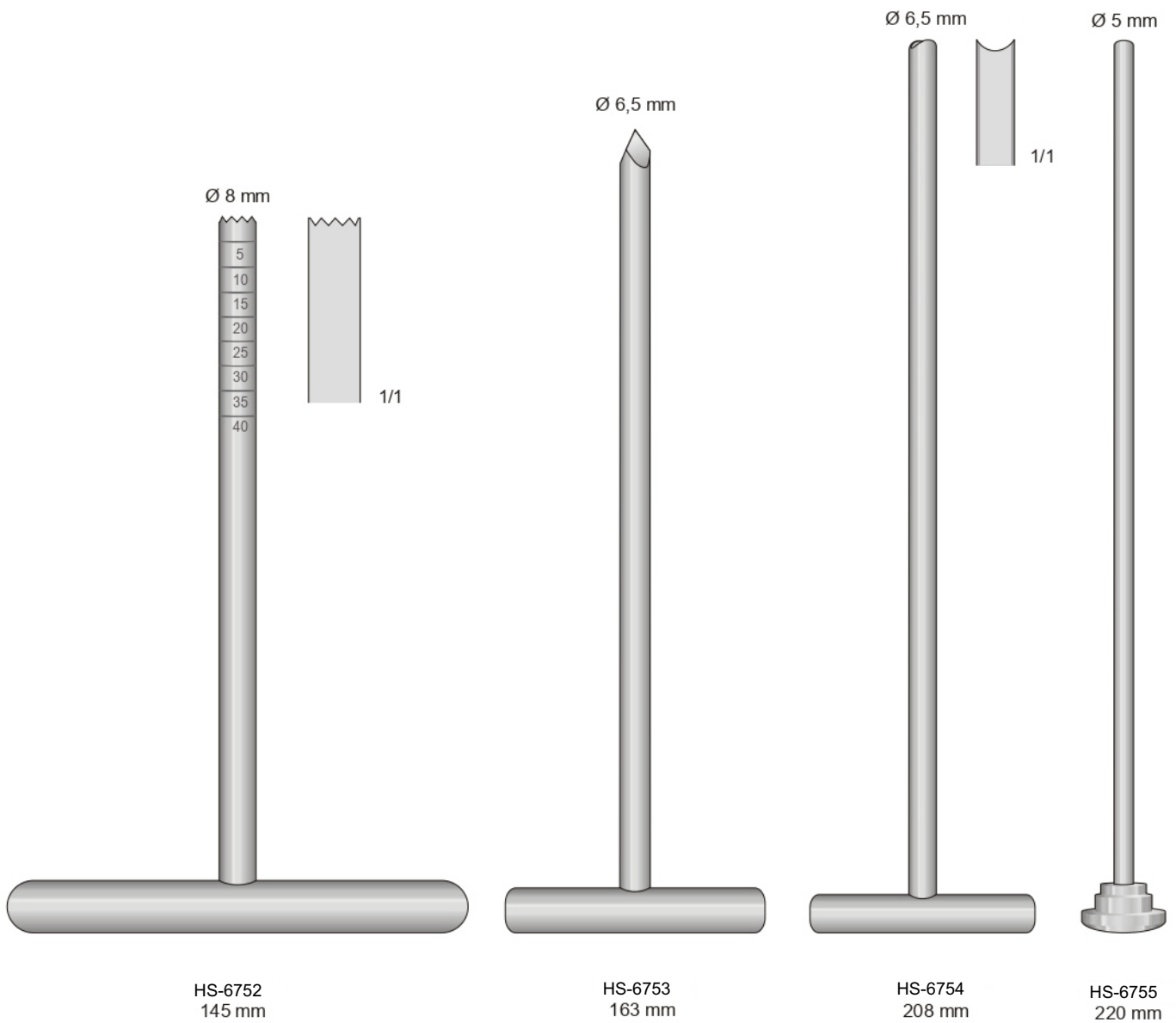

Set completo di 4 pezzi
Set complete with 4 pieces
Kompletset mit 4 Teilen
Set complet avec 4 pièces
Set completo con 4 piezas

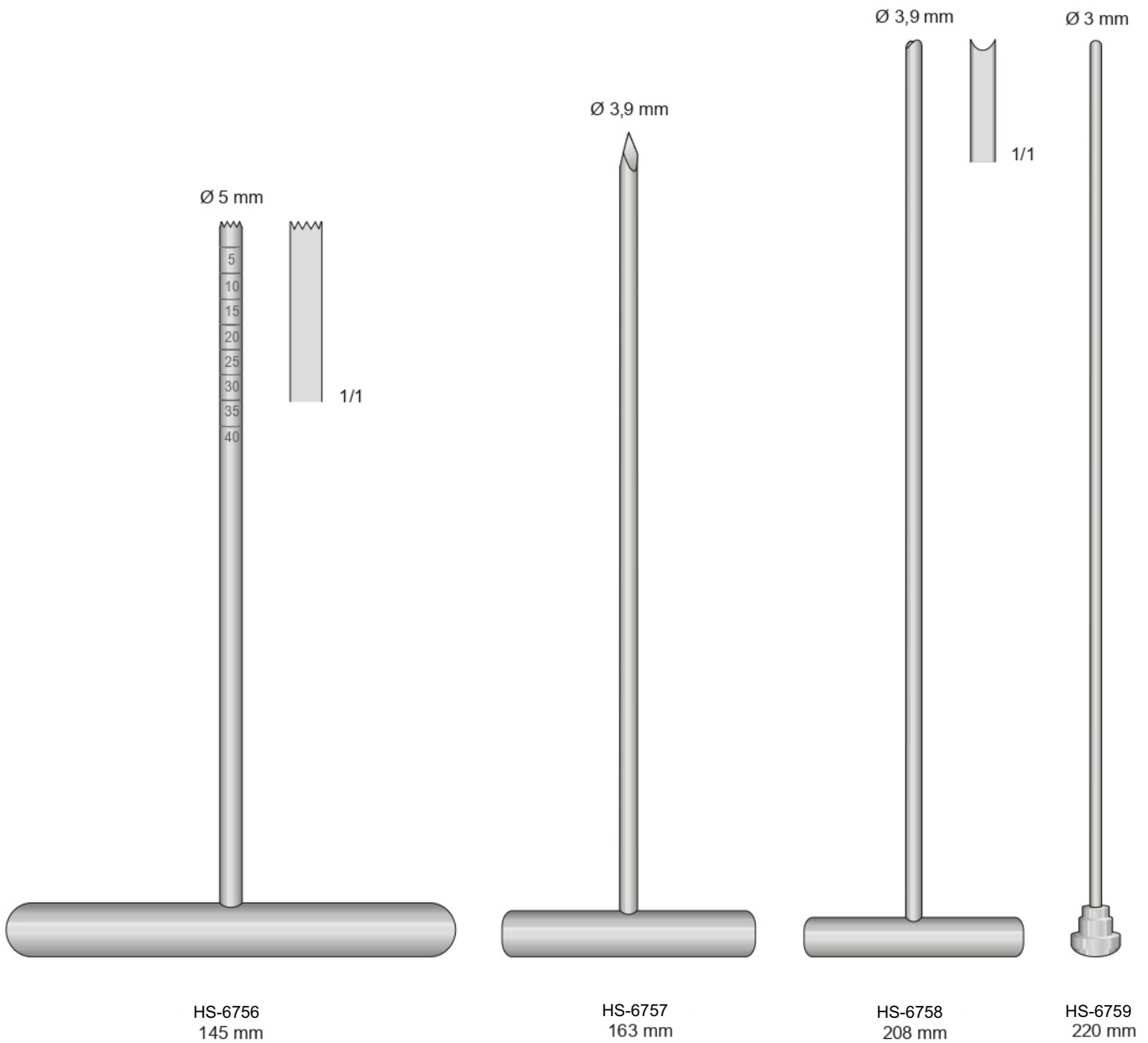



KIRSCHNER
Punta trequarti
Trocar point
Trokar Spitze
Pointe de Trocart
Punta de tròcar



KIRSCHNER
Punta trequarti
Trocar point
Trokar Spitze
Pointe de Trocart
Punta de tròcar



KIRSCHNER
Punte lanceolate
Lance point
Lanzenspitze
Pointe lancette
Punta lanceolar

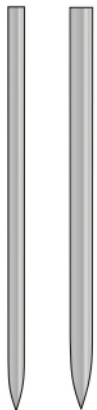

Punta trequarti
Trocar point
Trokar Spitze
Pointe de Trocart
Punta de tròcar

310 mm

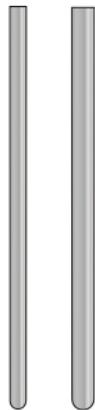

Punta rotonda
Round shaft
Rundes ende
Pointe ronde
Punta redonda

310 mm

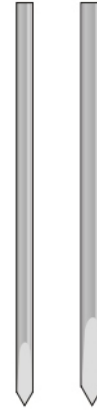

Punte lanceolate
Lance point
Lanzenspitze
Pointe lancette
Punta lanceolar

310 mm

| Ø/Diam. | Conf. 10 pz. |
|---------|--------------|
| 0,8 mm | HS-6760-1 |
| 1,0 mm | HS-6760-2 |
| 1,2 mm | HS-6760-3 |
| 1,4 mm | HS-6760-4 |
| 1,5 mm | HS-6760-5 |
| 1,6 mm | HS-6760-6 |
| 1,7 mm | HS-6760-7 |
| 1,8 mm | HS-6760-8 |
| 2,0 mm | HS-6760-9 |
| 2,2 mm | HS-6760-10 |
| 2,5 mm | HS-6760-11 |
| 3,0 mm | HS-6760-12 |

| Ø/Diam. | Conf. 10 pz. |
|---------|--------------|
| 0,8 mm | HS-6761-1 |
| 1,0 mm | HS-6761-2 |
| 1,2 mm | HS-6761-3 |
| 1,4 mm | HS-6761-4 |
| 1,5 mm | HS-6761-5 |
| 1,6 mm | HS-6761-6 |
| 1,7 mm | HS-6761-7 |
| 1,8 mm | HS-6761-8 |
| 2,0 mm | HS-6761-9 |
| 2,2 mm | HS-6761-10 |
| 2,5 mm | HS-6761-11 |
| 3,0 mm | HS-6761-12 |

| Ø/Diam. | Conf. 10 pz. |
|---------|--------------|
| 0,8 mm | HS-6762-1 |
| 1,0 mm | HS-6762-2 |
| 1,2 mm | HS-6762-3 |
| 1,5 mm | HS-6762-4 |
| 1,6 mm | HS-6762-5 |
| 1,8 mm | HS-6762-6 |
| 2,0 mm | HS-6762-7 |
| 2,2 mm | HS-6762-8 |
| 2,5 mm | HS-6762-9 |
| 3,0 mm | HS-6762-10 |



KIRSCHNER
Punta tre quarti
Trocar point
Trokar Spitze
Pointe de Trocart
Punta de tròcar



KIRSCHNER
Punta tre quarti
Trocar point
Trokar Spitze
Pointe de Trocart
Punta de tròcar



15 mm

Con filettatura
With thread
Mit gewinde
Avec filetage
Con rosca

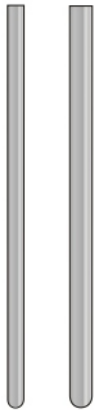

Punta rotonda
Round shaft
Rundes ende
Pointe ronde
Punta redonda

150 mm



Punta tre quarti
Trocar point
Trokar Spitze
Pointe de Trocart
Punta de tròcar

150 mm



Rotonda
Round
Runde
Ronde
Redonda

Ø

| Ø/Diam. | Conf. 10 pz. |
|---------|--------------|
| 0,8 mm | HS-6763-1 |
| 1,0 mm | HS-6763-2 |
| 1,2 mm | HS-6763-3 |
| 1,4 mm | HS-6763-4 |
| 1,5 mm | HS-6763-5 |
| 1,6 mm | HS-6763-6 |
| 1,7 mm | HS-6763-7 |
| 1,8 mm | HS-6763-8 |
| 2,0 mm | HS-6763-9 |
| 2,2 mm | HS-6763-10 |
| 2,5 mm | HS-6763-11 |
| 3,0 mm | HS-6763-12 |

| Ø/Diam. | Conf. 10 pz. |
|---------|--------------|
| 0,8 mm | HS-6764-1 |
| 1,0 mm | HS-6764-2 |
| 1,2 mm | HS-6764-3 |
| 1,4 mm | HS-6764-4 |
| 1,6 mm | HS-6764-5 |

| KIRSCHNER | | | |
|-----------|------|-------|------------|
| Codice | Ø mm | Lung. | Lung. filo |
| HS-6765-1 | 1,5 | 150 | 5 |
| HS-6765-1 | 1,6 | 150 | 15 |
| HS-6765-1 | 2 | 150 | 15 |
| HS-6765-1 | 2 | 200 | 15 |

KIRSCHNER

Bundel-Nagel



500 mm

Steinmann pins



310 mm

Küntscher

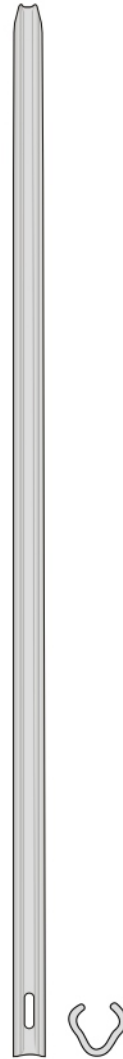

400 mm

Threaded Steinmann Pins



230 mm

Runde

| Ø/Diam. | Conf. 10 pz. |
|---------|--------------|
| 2,0 mm | HS-6766-1 |
| 2,5 mm | HS-6766-2 |
| 3,0 mm | HS-6766-3 |
| 3,5 mm | HS-6766-4 |
| 4,0 mm | HS-6766-5 |
| 4,5 mm | HS-6766-6 |
| 5,0 mm | HS-6766-7 |
| 5,5 mm | HS-6766-8 |
| 6,0 mm | HS-6766-9 |

| Ø/Diam. | Conf. 1 pz. |
|---------|-------------|
| 3,5 mm | HS-6767-1 |
| 4,0 mm | HS-6767-2 |
| 4,5 mm | HS-6767-3 |
| 5,0 mm | HS-6767-4 |
| 6,0 mm | HS-6767-5 |
| 6,5 mm | HS-6767-6 |

| Ø/Diam. | Conf. 1 pz. |
|---------|-------------|
| 6,0 mm | HS-6768-1 |
| 7,0 mm | HS-6768-2 |
| 8,0 mm | HS-6768-3 |
| 9,0 mm | HS-6768-4 |
| 10 mm | HS-6768-5 |
| 11 mm | HS-6768-6 |
| 12 mm | HS-6768-7 |

| Ø/Diam. | Conf. 1 pz. |
|---------|-------------|
| 2,0 mm | HS-6769-1 |
| 2,5 mm | HS-6769-2 |

Steinmann Pins with Central Thread with Trocar Point

Contenitore per
sterilizzazione Kirschner
Bohrdrahtspender

Positivo
Thread - Ø is 0,5 mm
more than pin - Ø

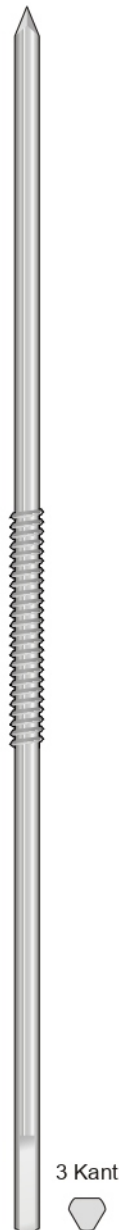

| STEINMANN PINS | | | |
|----------------|------|-------|------------------|
| Codice | Ø mm | Lung. | Lung. Filo mm |
| HS-6770-1 | 3 | 150 | 37 |
| HS-6770-2 | 3 | 180 | 48 |
| HS-6770-3 | 3 | 200 | 50 |
| HS-6770-4 | 3 | 230 | 52 |
| HS-6770-5 | 3,5 | 150 | 37 |
| HS-6770-6 | 3,5 | 180 | 52 |
| HS-6770-7 | 3,5 | 200 | 52 |
| HS-6770-8 | 3,5 | 230 | 52 |
| HS-6770-9 | 4 | 150 | 37 |
| HS-6770-10 | 4 | 180 | 52 |
| HS-6770-11 | 4 | 200 | 50 |
| HS-6770-12 | 4 | 230 | 52 |
| HS-6770-13 | 4 | 250 | 52 |
| HS-6770-14 | 4,5 | 150 | 37 |
| HS-6770-15 | 4,5 | 180 | 52 |
| HS-6770-16 | 4,5 | 200 | 52 |
| HS-6770-17 | 4,5 | 230 | 52 |
| HS-6770-18 | 4,5 | 250 | 52 |
| HS-6770-19 | 4,5 | 300 | 52 |
| HS-6770-20 | 5 | 150 | 37 |
| HS-6770-21 | 5 | 180 | 52 |
| HS-6770-22 | 5 | 200 | 50 |
| HS-6770-23 | 5 | 230 | 52 |
| HS-6770-24 | 5 | 250 | 52 |
| HS-6770-25 | 5 | 300 | 52 |

Ø 10 mm



HS-6770 _

HS-6771-1 - 320 mm
HS-6771-2 - 185 mm

Viti di Schanz
Schanz screws
Schanz'sche Schrauben
Vis de Schanz

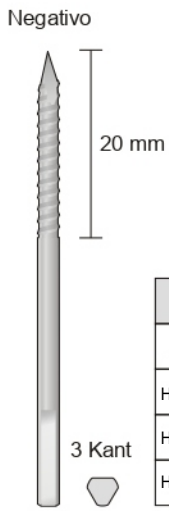

| SCHANZ | | | |
|-----------|------|-------|------------|
| Codice | Ø mm | Lung. | Lung. filo |
| HS-6772-1 | 3 | 60 | 20 |
| HS-6772-2 | 3 | 80 | 20 |
| HS-6772-3 | 4 | 60 | 25 |

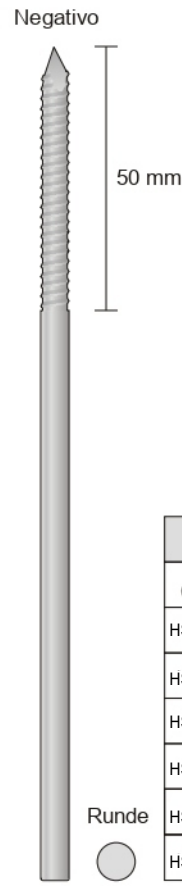

| SCHANZ | | | |
|-----------|------|-------|------------|
| Codice | Ø mm | Lung. | Lung. filo |
| HS-6773-1 | 2 | 150 | 50 |
| HS-6773-2 | 3 | 150 | 50 |
| HS-6773-3 | 3,5 | 150 | 50 |
| HS-6773-4 | 4 | 150 | 50 |
| HS-6773-5 | 4,5 | 150 | 50 |
| HS-6773-6 | 5 | 150 | 50 |

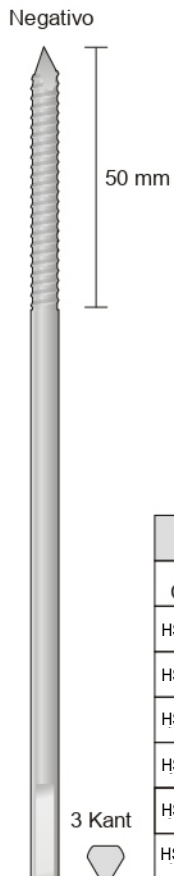

| SCHANZ | | | |
|-----------|------|-------|------------|
| Codice | Ø mm | Lung. | Lung. filo |
| HS-6774-1 | 2 | 150 | 50 |
| HS-6774-2 | 3 | 150 | 50 |
| HS-6774-3 | 3,5 | 150 | 50 |
| HS-6774-4 | 4 | 150 | 50 |
| HS-6774-5 | 4,5 | 150 | 50 |
| HS-6774-6 | 5 | 150 | 50 |

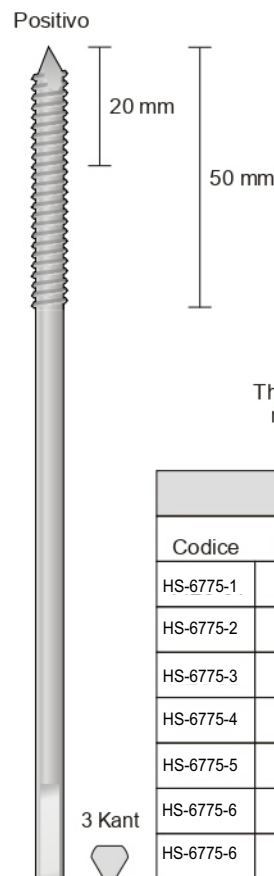

Thread - Ø is 0,5 mm more than pin - Ø

| SCHANZ | | | |
|-----------|------|-------|------------|
| Codice | Ø mm | Lung. | Lung. filo |
| HS-6775-1 | 2 | 150 | 20 |
| HS-6775-2 | 3 | 150 | 20 |
| HS-6775-3 | 3,5 | 150 | 50 |
| HS-6775-4 | 4 | 150 | 25 |
| HS-6775-5 | 4 | 150 | 50 |
| HS-6775-6 | 4,5 | 150 | 50 |
| HS-6775-6 | 5 | 150 | 50 |

Strumenti per filo di cerchiaggio
Wire instrument set
Drahtinstrumentarium
Instruments à fil
Instrumental para cerclaje

Filo malleabile
per compattare l'osso
Wire soft
Draht weich
Fil à os
Alambre ligadura



10 mt.

| Ø/Diam. | Codice |
|---------|------------|
| 0,2 mm | HS-6776-1 |
| 0,3 mm | HS-6776-2 |
| 0,4 mm | HS-6776-3 |
| 0,5 mm | HS-6776-4 |
| 0,6 mm | HS-6776-5 |
| 0,7 mm | HS-6776-6 |
| 0,8 mm | HS-6776-7 |
| 0,9 mm | HS-6776-8 |
| 1,0 mm | HS-6776-9 |
| 1,2 mm | HS-6776-10 |
| 1,5 mm | HS-6776-11 |

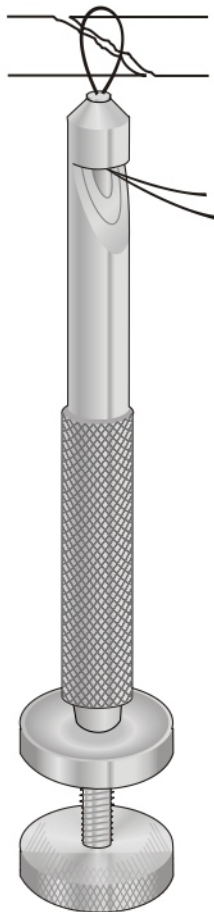

LOUTE
HS-6776
220 mm

Strumenti tendifili
Bone wire tighteners
Drahtspanninstrument
Tendeur serre fils
Tensor cierra-hilos

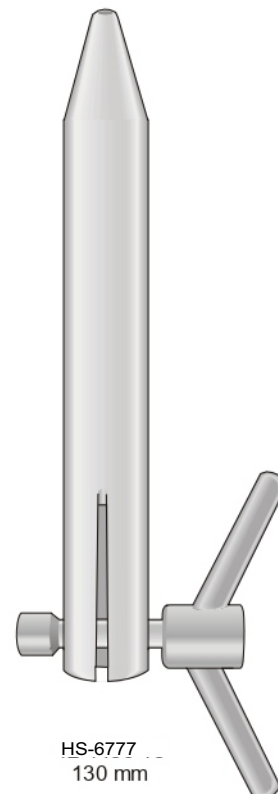

HS-6777
130 mm



Fino a Ø 3 mm
Bis Ø 3 mm
Up to Ø 3 mm

Gancio d'estrazione
Extraction hooks
Extraktions haken
Crochets d'extraction
Ganchos extractores

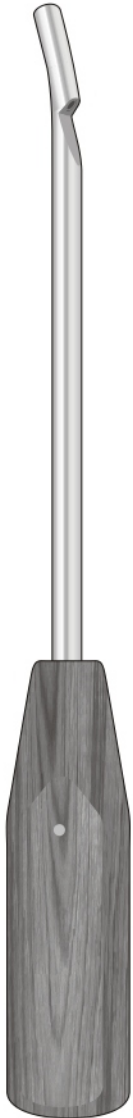

WAGNER
12-1460-30
300 mm

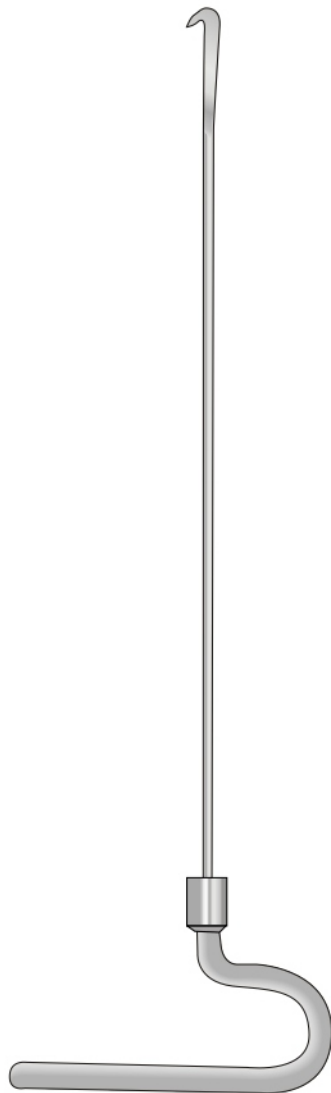

HS-6779 - 290 mm
HS-6780 - 370 mm
HS-6781 - 420 mm



HS-6782
120 mm



KÜNTSCHNER
HS-6783
210 mm

HS-6784
Completo con - Complete with
Komplett mit - Completes avec
Completo con:
1 LS-236
1 LS-229
1 LS-241

Attacco AO

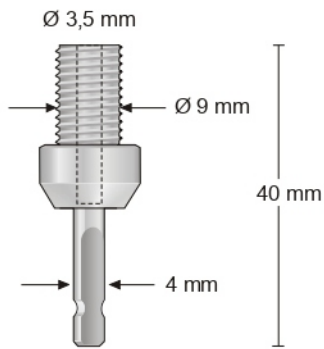

HS-6784-1
40 mm

Inox
ORIGINAL JACOBS

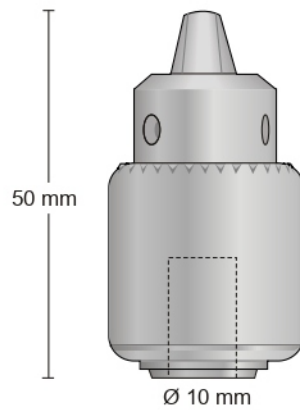

HS-6784-2
50 mm

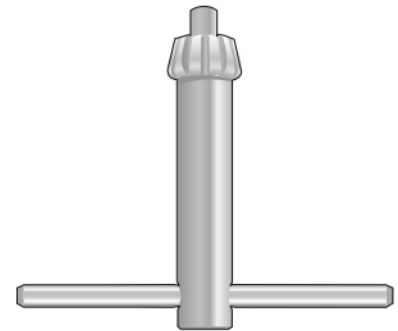

HS-6784-3
52 mm

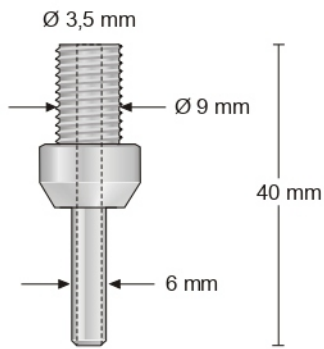

HS-6784-4
40 mm

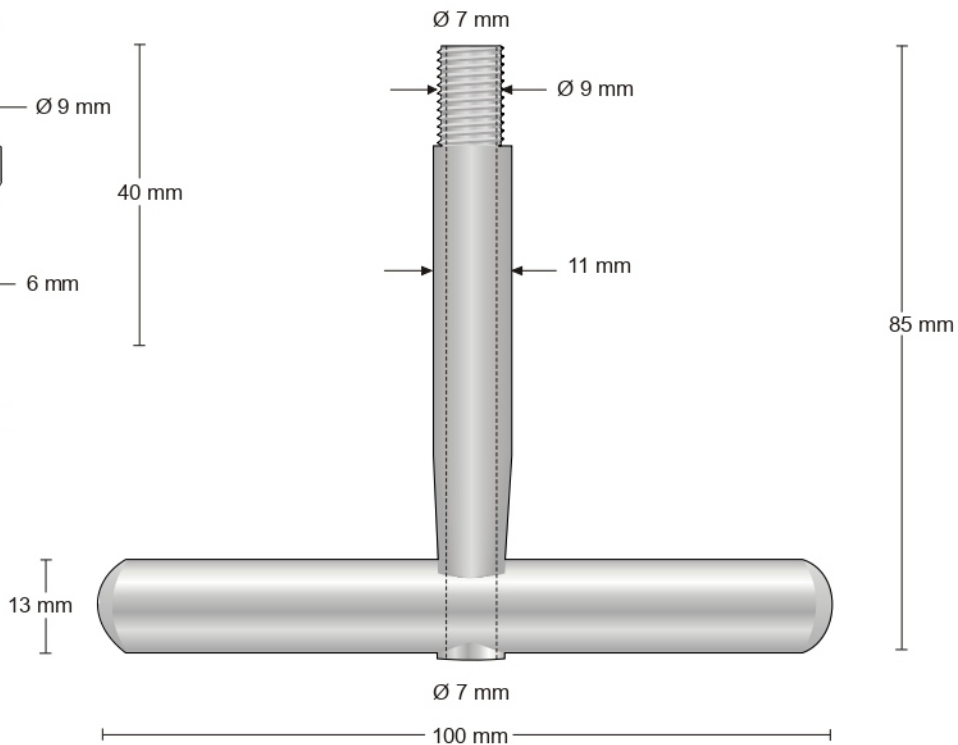

HS-6784-5
85 mm

HS-6785
 Completo con - Complete with
 Komplet mit - Completes avec
 Completos con:
 1
 1
 1
 1

Inox
 ORIGINAL JACOBS

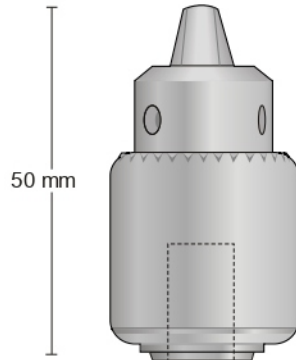

Ø 10 mm

HS-6785-01
 50 mm

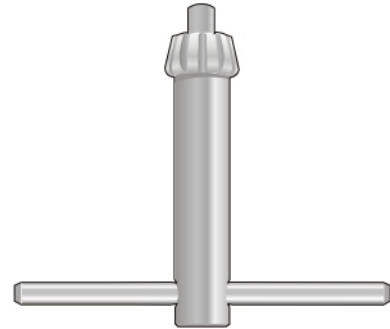

HS-6785-04
 52 mm

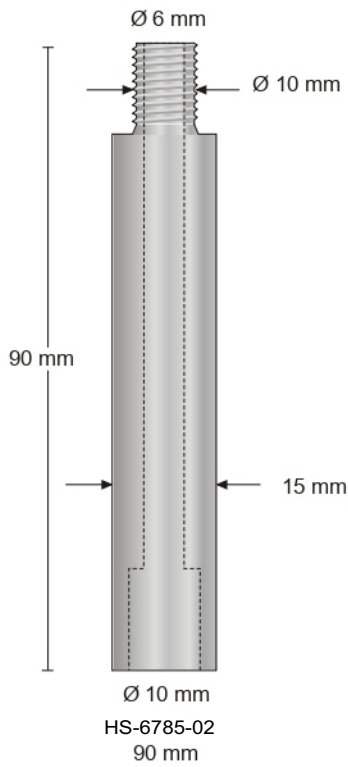

Ø 10 mm
 HS-6785-02
 90 mm

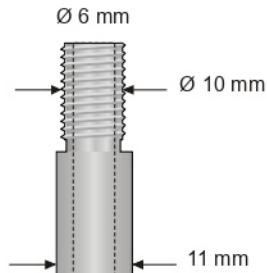

130 mm

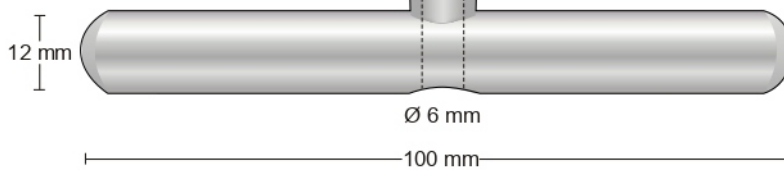

HS-6785-03
 130 mm

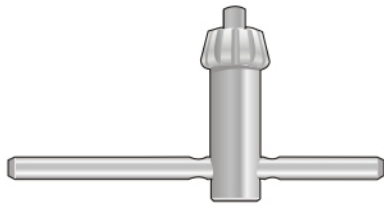

HS-6786-2
32 mm

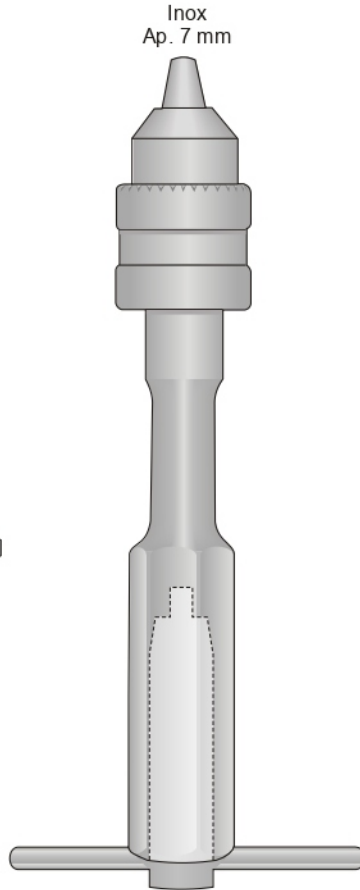

Inox
Ap. 7 mm

HS-6786-1
130 mm

Con chiusura a mano
Von Hand zu spannen
tightened by hand

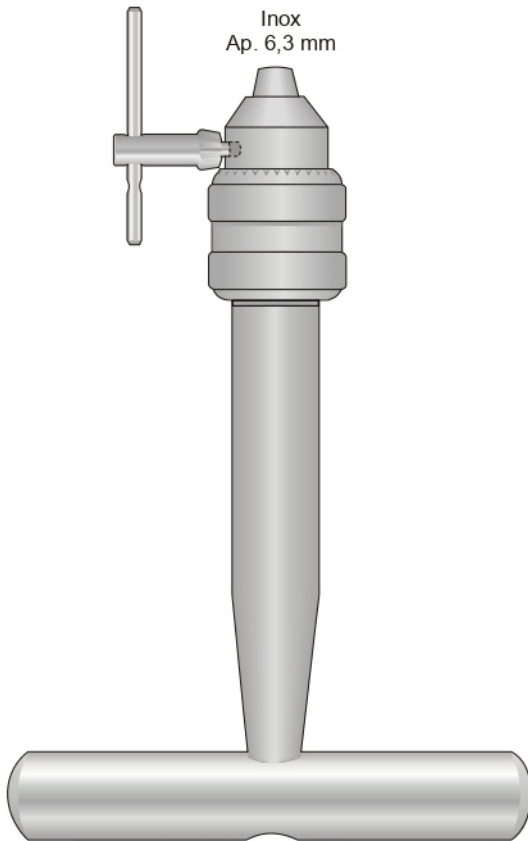

Inox
Ap. 6,3 mm

HS-6787
130 mm

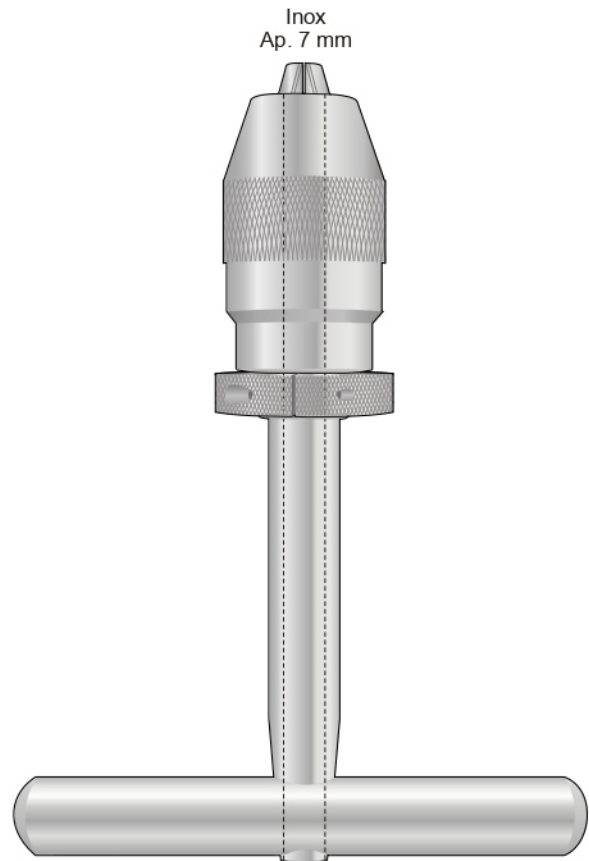

Inox
Ap. 7 mm

HS-6788
135 mm



DEMEL
12-1560

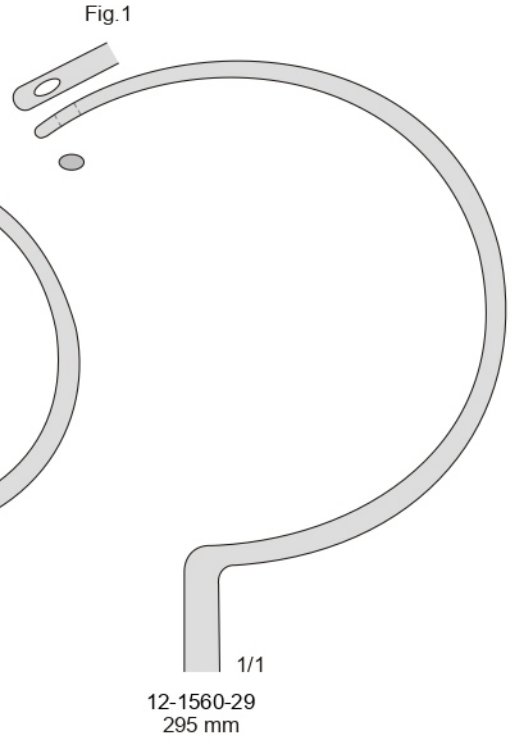
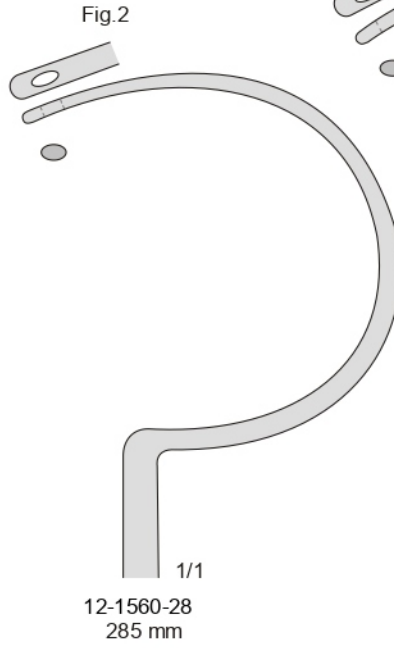
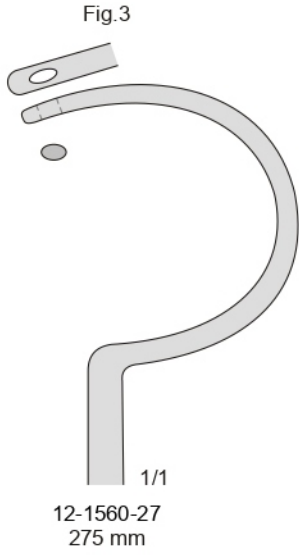

HS-6790
225 mm

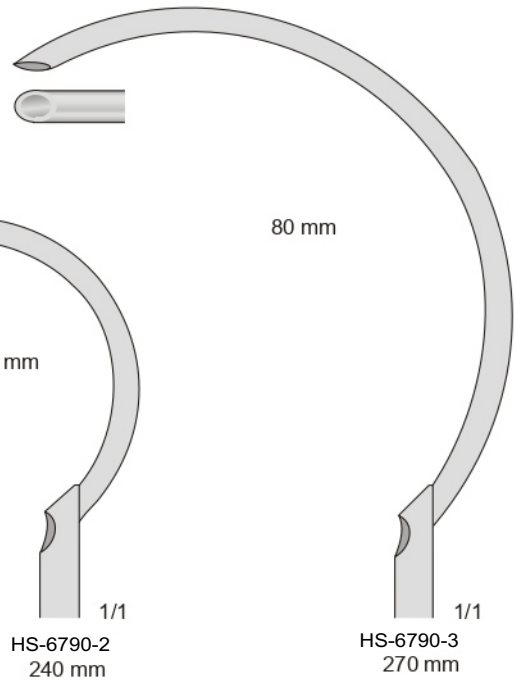
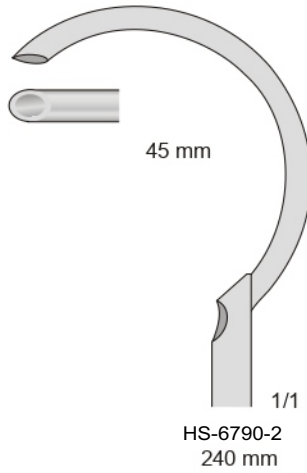
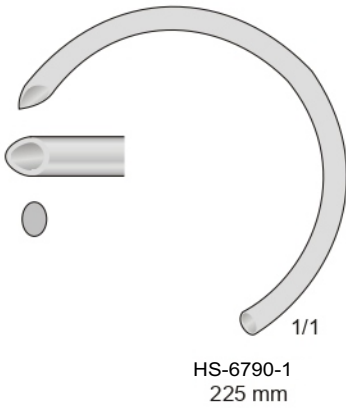

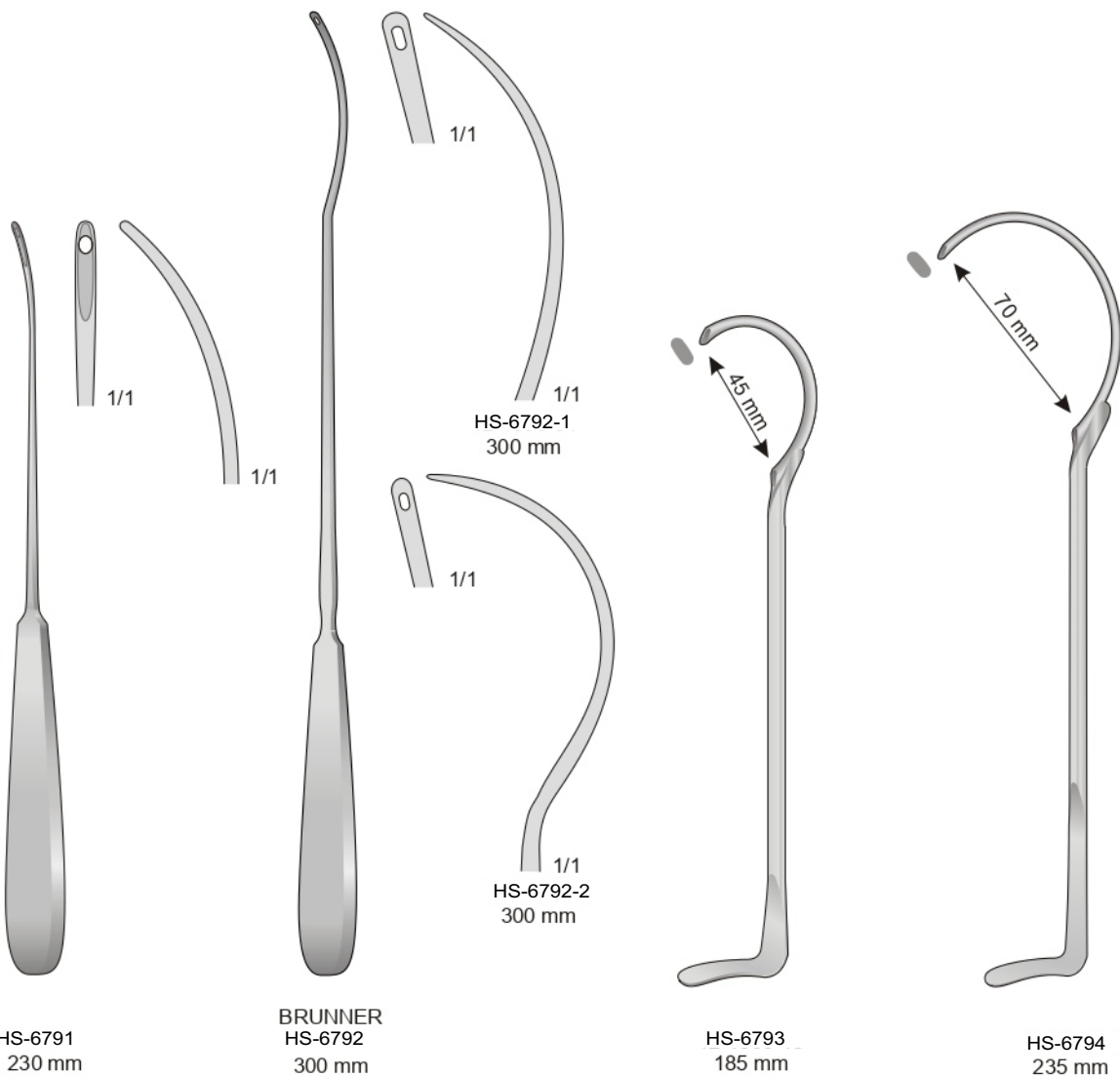

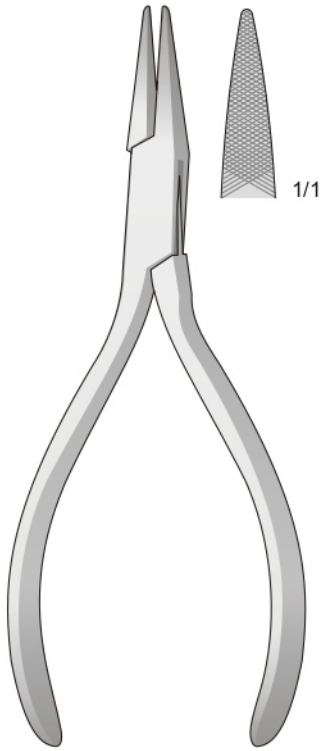

HS-6795
140 mm

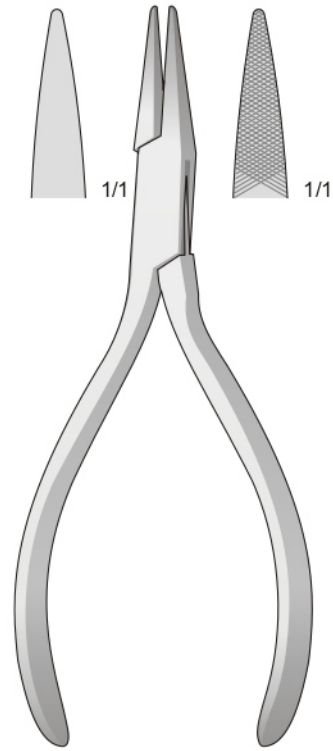

HS-6796
140 mm

Per filo duro ø 1 mm
 For hard wire ø 1 mm
 Für harten draht ø 1 mm
 Pour fil dur ø 1 mm
 Para alambres duro ø 1 mm

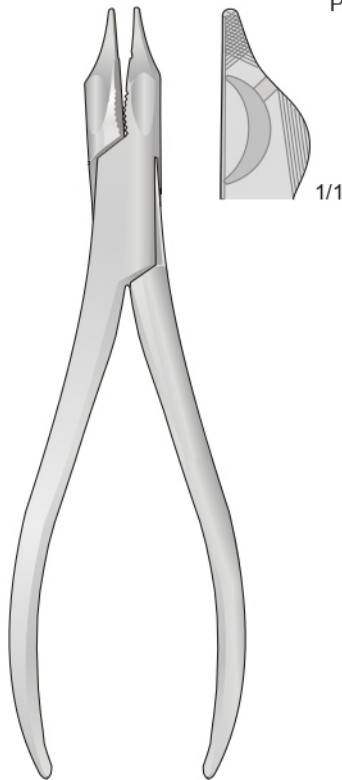

HS-6797
150 mm

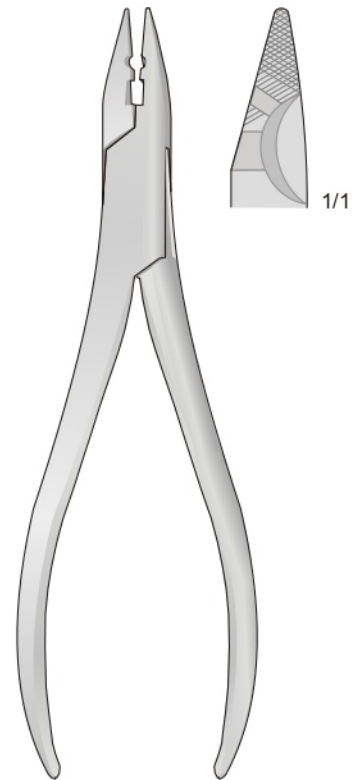

HS-6798
160 mm



Extraction Pliers For Boring Wires

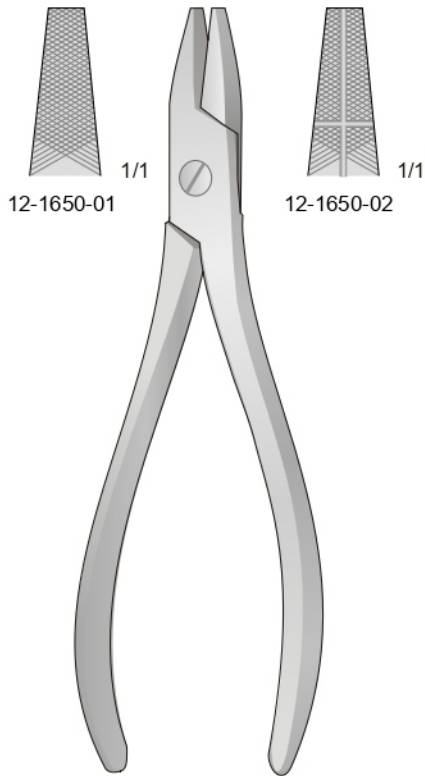

HS-6799
175 mm

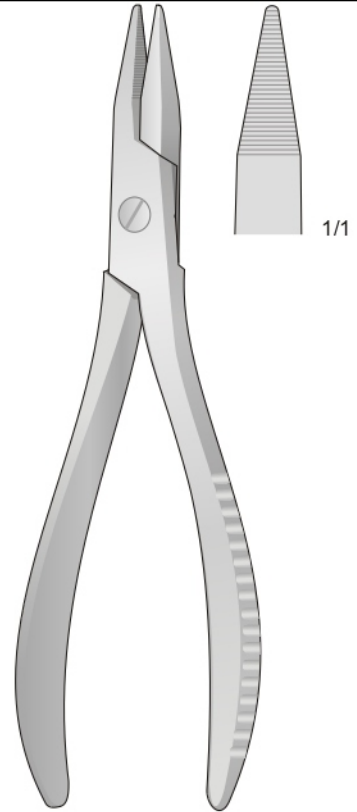

HS-6800
190 mm

Pinza per estrazione
fili metallici
Flachzangen für draht

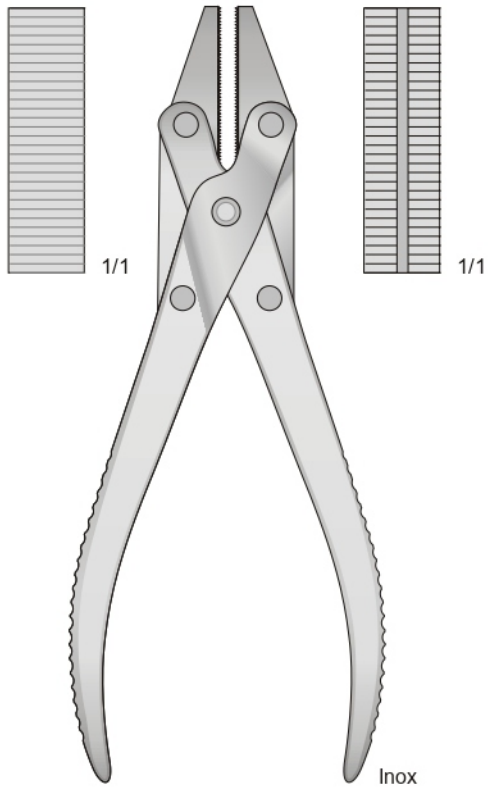

HS-6801
185 mm

Inox

Pinza a branche parallele
con tronchese

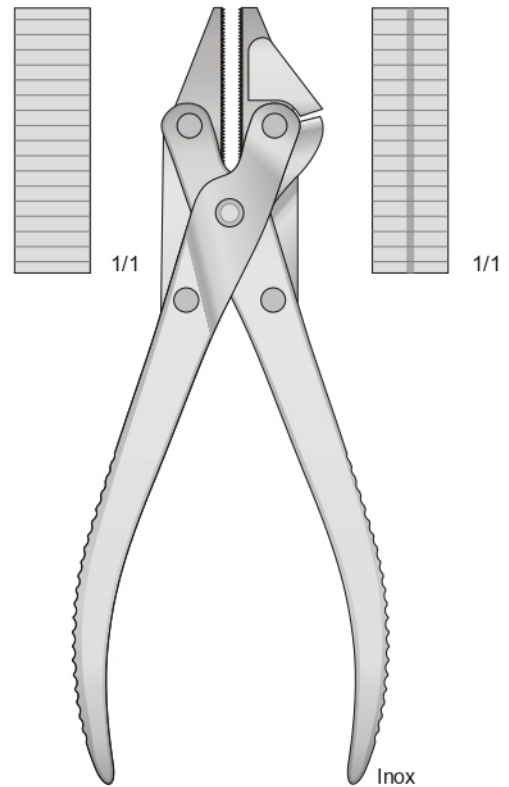

HS-6802
185 mm

Inox

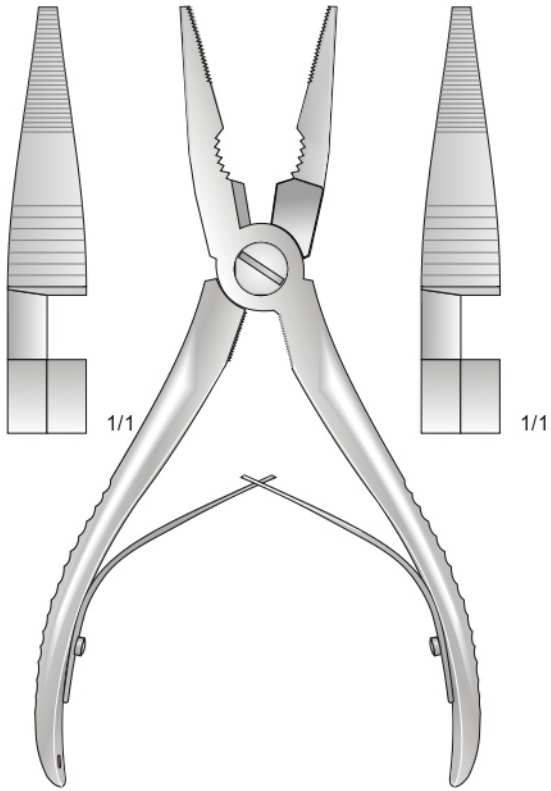

HS-6803
175 mm

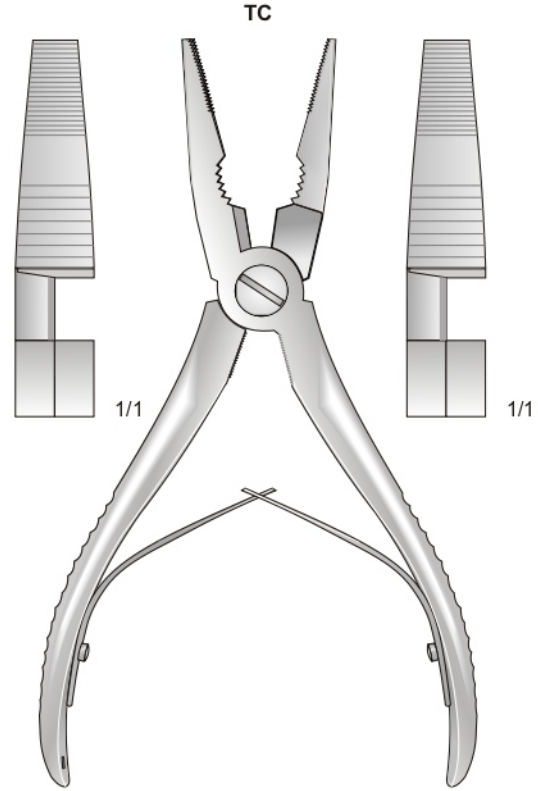

HS-6804
165 mm

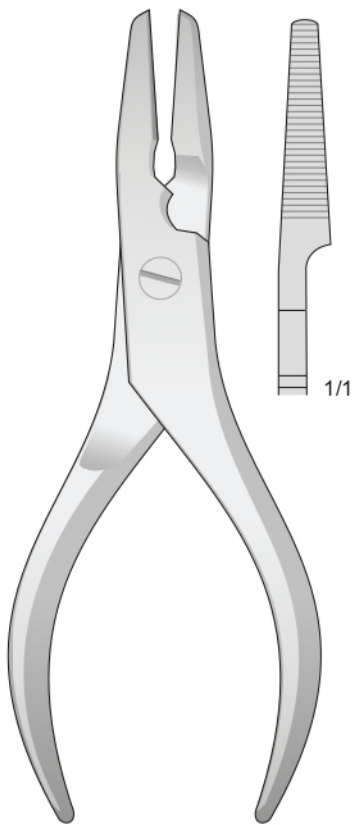

HS-6805
160 mm

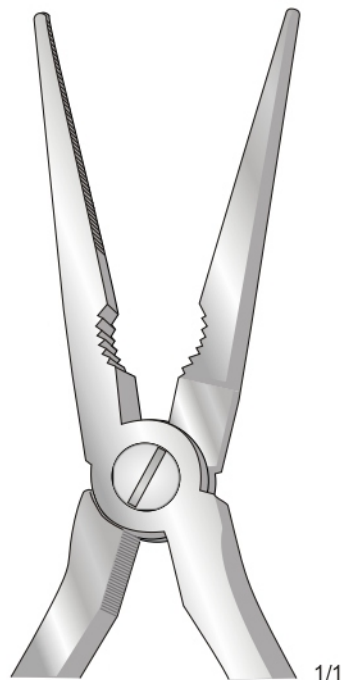

12-1700-20
200 mm

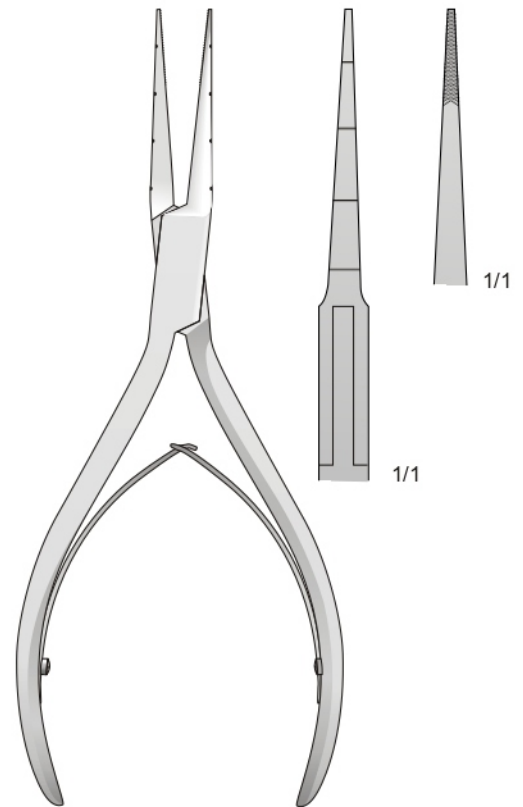

HS-6806
150 mm

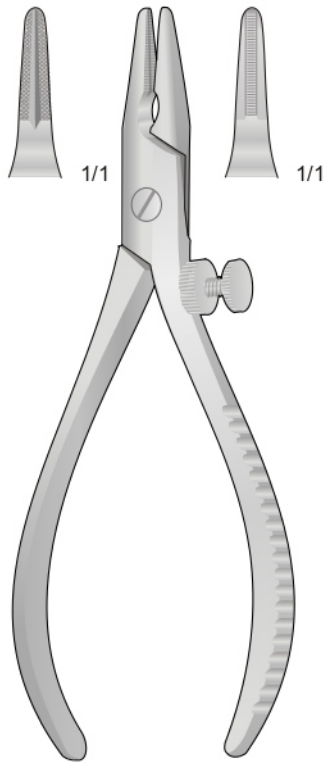

HS-6807
140 mm

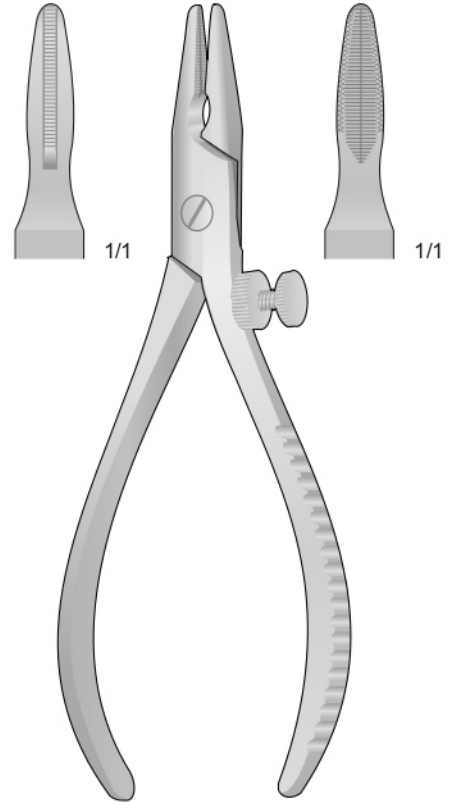

HS-6808
180 mm

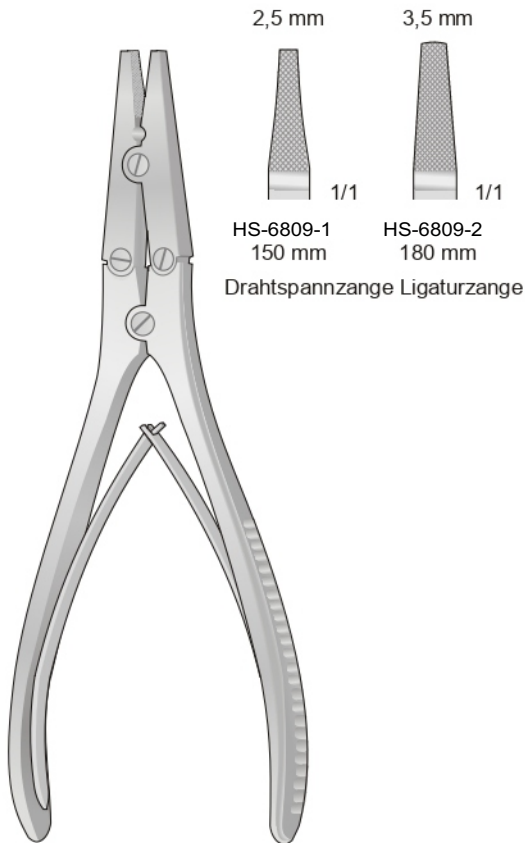

HS-6809

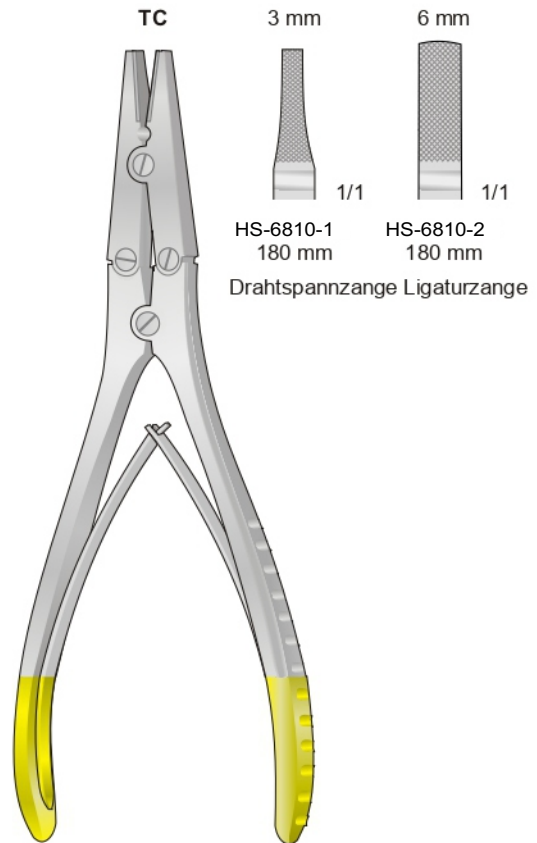

HS-6810

Wire Cutting Pliers

Per fili duri di \varnothing 0,4 mm - For hard wire with \varnothing 0,4 mm
 Für harten Draht bis \varnothing 0,4 mm - Pour fils durs avec \varnothing 0,4 mm
 Para hilos duros de \varnothing 0,4 mm

Per filo duro \varnothing 1 mm - Für harten draht \varnothing 1 mm
 For hard wire \varnothing 1 mm - Pour fil dur avec \varnothing 1 mm
 Para alambres duro \varnothing 1 mm

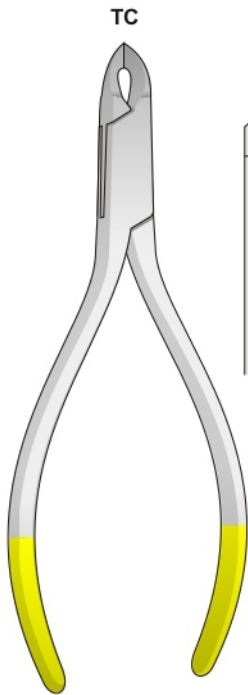

ANGLE
 HS-6811
 130 mm

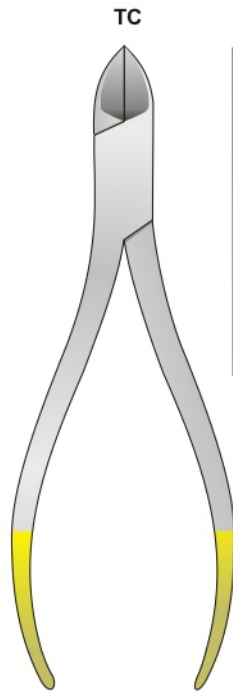

HS-6812
 130 mm

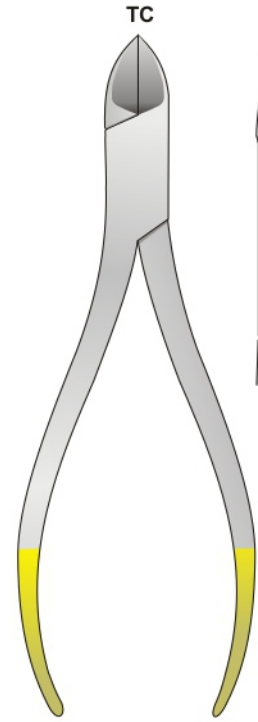

HS-6813
 150 mm

Per filo duro \varnothing 1 mm - Für harten draht \varnothing 1 mm
 For hard wire \varnothing 1 mm - Pour fil dur avec \varnothing 1 mm
 Para alambres duro \varnothing 1 mm

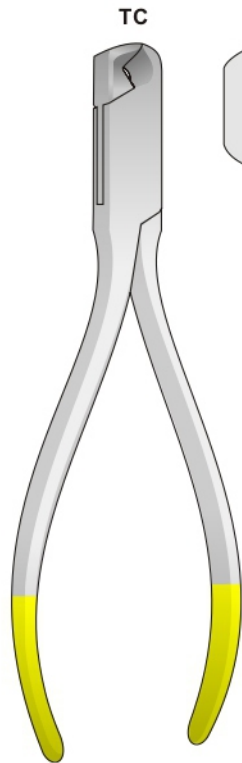

HS-6814
 145 mm



HS-6815
 185 mm



Port'aghi, pinze per fili d'acciaio
Needle holders, wire forceps
Nadelhalter, Draht-zangen
Porte aiguilles, pinces à saisir
Porta agujas, pinzas para hilos

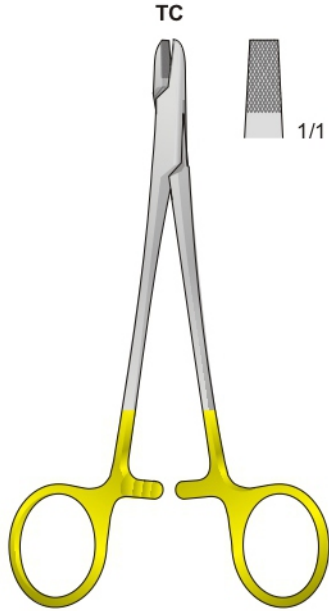

HS-6816
150 mm

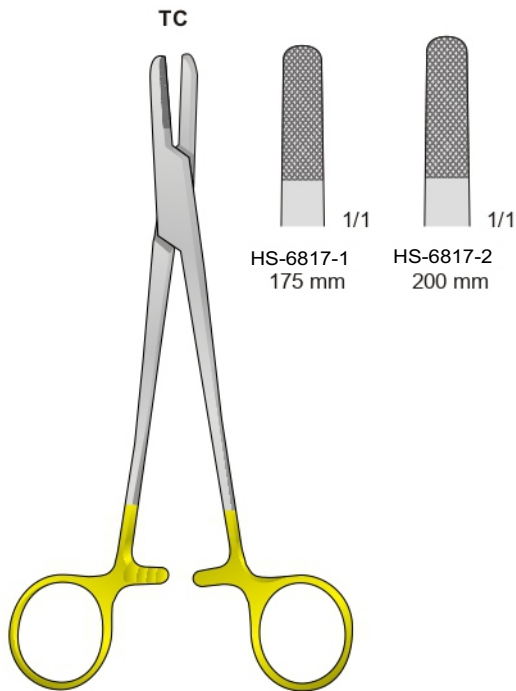

HS-6817

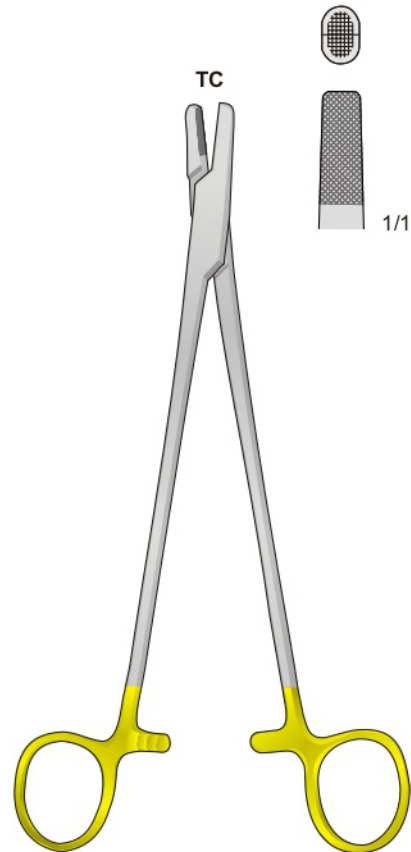

BAUMGARTNER
HS-6818
200 mm

Extraction Pliers For Boring Wires

Forbice universale dentellata - Draht-und Blehschere gezahnt
Wire cutting scissor serrated - Ciseaux à couper les fils métalliques
Tijeras para cortar hilo de acero dentadas

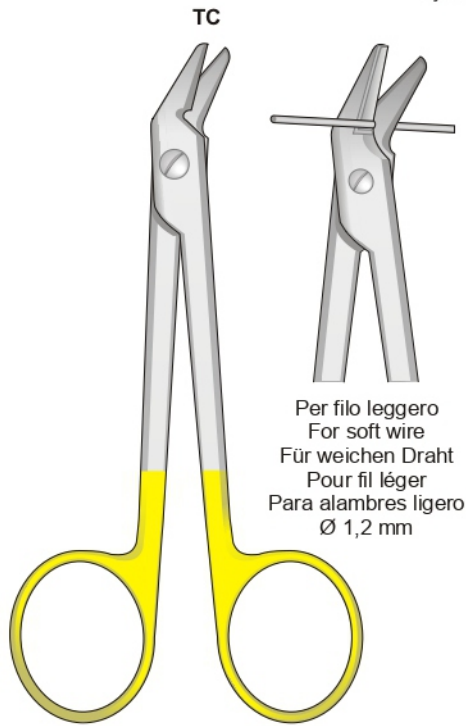

HS-6819
120 mm

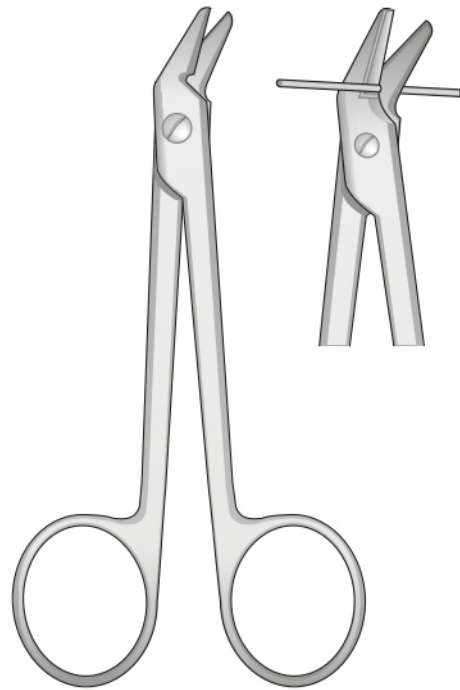

HS-6820
120 mm

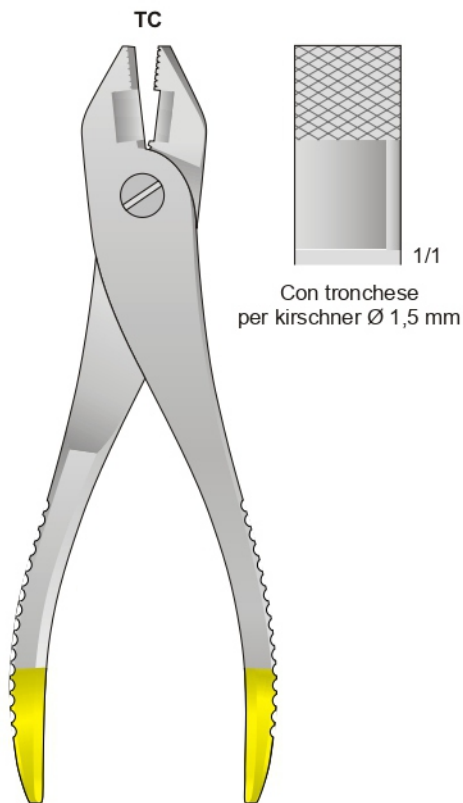

HS-6821
220 mm

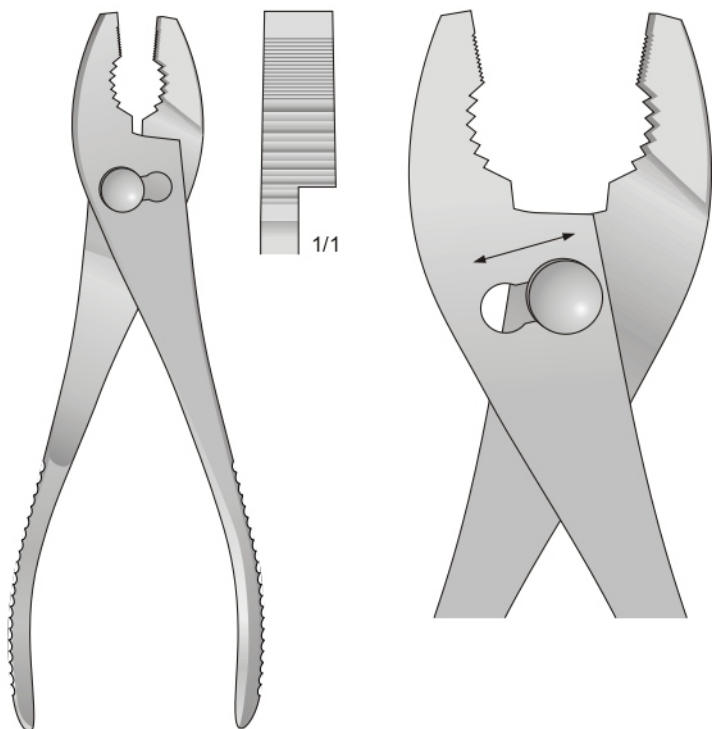

HS-6822
200 mm



Per filo leggero Ø 2 mm
 Per filo duro Ø 1,5 mm
 For soft wire Ø 2 mm
 For hard wire Ø 1,5 mm
 Für weichen Draht Ø 2 mm
 Für harten Draht Ø 1,5 mm
 Pour fil léger Ø 2 mm
 Pour fil dur Ø 1,5 mm
 Para alambres ligero Ø 2 mm
 Para alambres duro Ø 1,5 mm

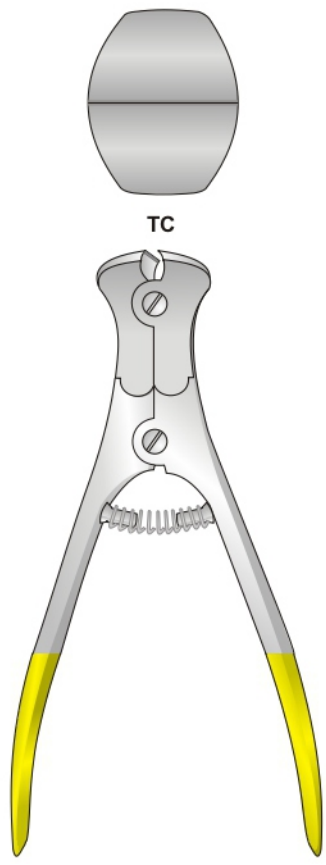

HS-6823
145 mm

Per filo leggero Ø 2 mm
 Per filo duro Ø 1,6 mm
 For soft wire Ø 2 mm
 For hard wire Ø 1,6 mm
 Für weichen Draht Ø 2 mm
 Für harten Draht Ø 1,6 mm
 Pour fil léger Ø 2 mm
 Pour fil dur Ø 1,6 mm
 Para alambres ligero Ø 2 mm
 Para alambres duro Ø 1,6 mm

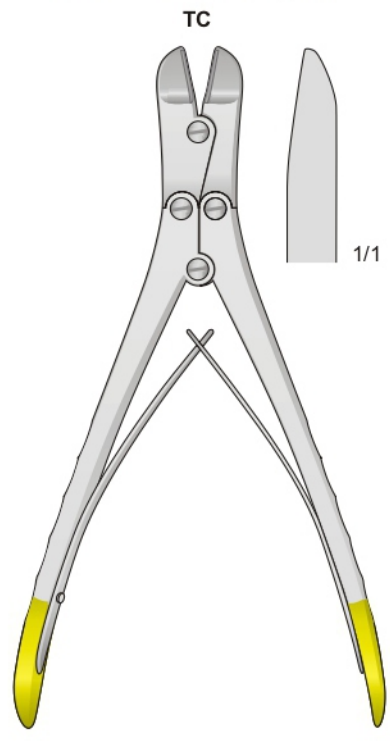

HS-6824
170 mm

Per filo leggero Ø 3,5 mm
 Per filo duro Ø 2,5 mm
 For soft wire Ø 3,5 mm
 For hard wire Ø 2,5 mm
 Für weichen Draht Ø 3,5 mm
 Für harten Draht Ø 2,5 mm
 Pour fil léger Ø 3,5 mm
 Pour fil dur Ø 2,5 mm
 Para alambres ligero Ø 3,5 mm
 Para alambres duro Ø 2,5 mm

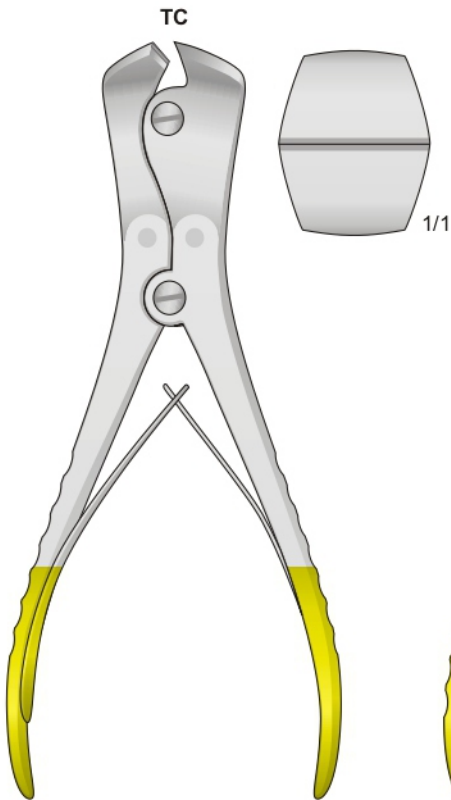

HS-6825
 215 mm

Per filo leggero Ø 3 mm
 Per filo duro Ø 2,2 mm
 For soft wire Ø 3 mm
 For hard wire Ø 2,2 mm
 Für weichen Draht Ø 3 mm
 Für harten Draht Ø 2,2 mm
 Pour fil léger Ø 3 mm
 Pour fil dur Ø 2,2 mm
 Para alambres ligero Ø 3 mm
 Para alambres duro Ø 2,2 mm

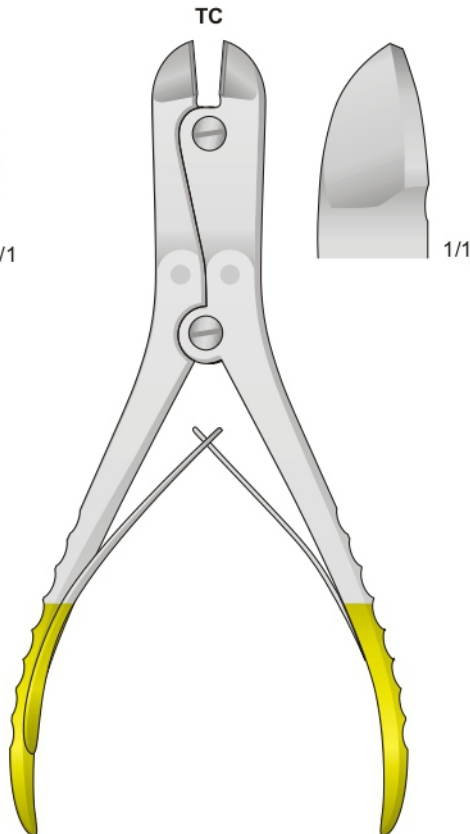

HS-6826
 230 mm

Per filo leggero Ø 2,5 mm
 Per filo duro Ø 2 mm
 For soft wire Ø 2,5 mm
 For hard wire Ø 2 mm
 Für weichen Draht Ø 2,5 mm
 Für harten Draht Ø 2 mm
 Pour fil léger Ø 2,5 mm
 Pour fil dur Ø 2 mm
 Para alambres ligero Ø 2,5 mm
 Para alambres duro Ø 2 mm

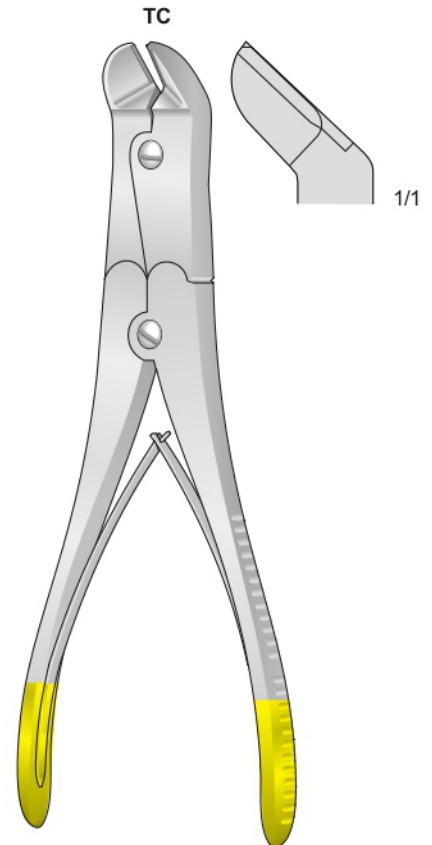

HS-6827
 230 mm



Per filo leggero Ø 7 mm
Per filo duro Ø 6 mm
For soft wire Ø 7 mm
For hard wire Ø 6 mm
Für weichen Draht Ø 7 mm
Für harten Draht Ø 6 mm
Pour fil léger Ø 7 mm
Pour fil dur Ø 6 mm
Para alambres ligero Ø 7 mm
Para alambres duro Ø 6 mm

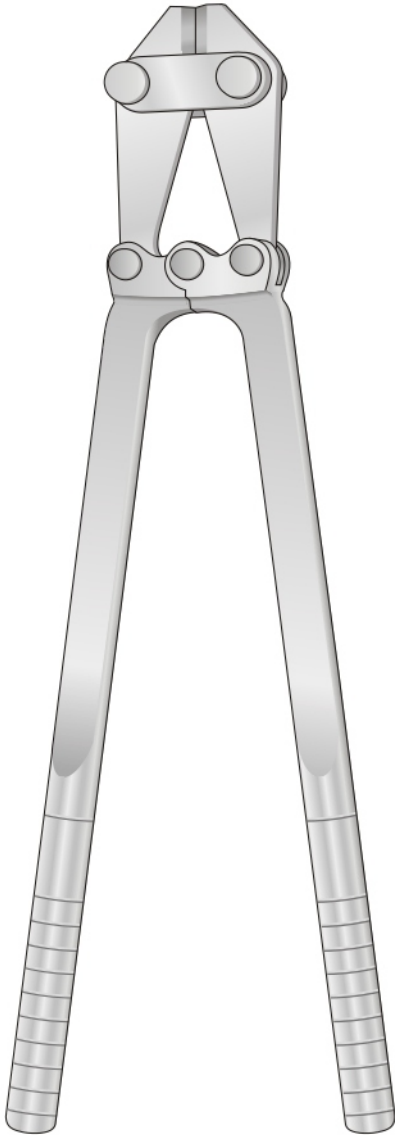

HS-6828
480 mm

Per filo leggero Ø 7 mm
Per filo duro Ø 6 mm
For soft wire Ø 7 mm
For hard wire Ø 6 mm
Für weichen Draht Ø 7 mm
Für harten Draht Ø 6 mm
Pour fil léger Ø 7 mm
Pour fil dur Ø 6 mm
Para alambres ligero Ø 7 mm
Para alambres duro Ø 6 mm

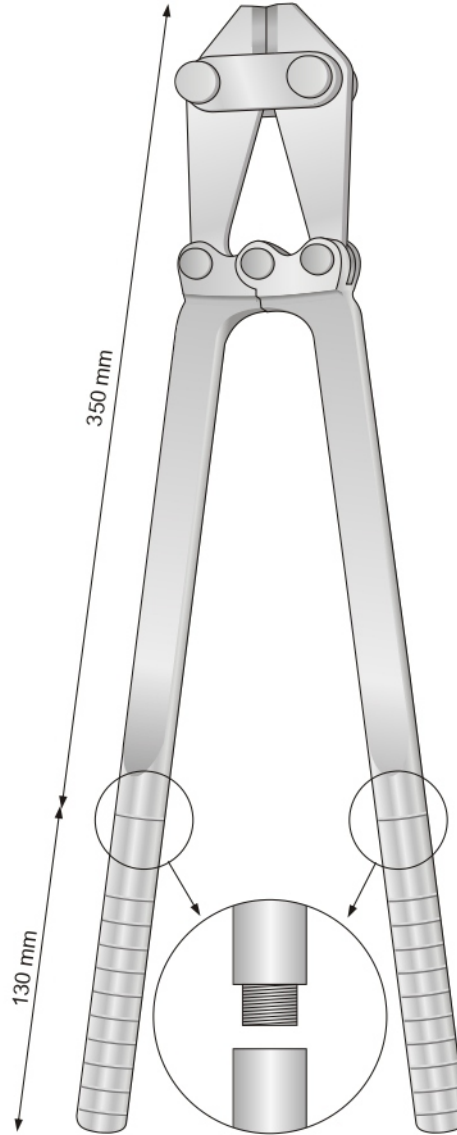

HS-6829
480 mm

Per filo leggero Ø 5 mm
Per filo duro Ø 4,5 mm
For soft wire Ø 5 mm
For hard wire Ø 4,5 mm
Für weichen Draht Ø 5 mm
Für harten Draht Ø 4,5 mm
Pour fil léger Ø 5 mm
Pour fil dur Ø 4,5 mm
Para alambres ligero Ø 5 mm
Para alambres duro Ø 4,5 mm

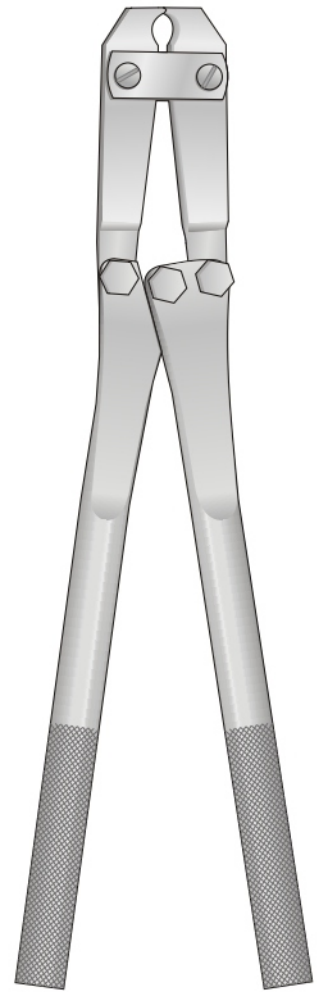

HS-6830
375 mm

Misuratore per chiodi Kirschner
Meßlehre für Kirschnerdrähte



0,5 mm



HS-6831
50 mm

0,5 mm



HS-6832
120 mm

0,5 mm



HS-6833
150 mm

0,5 mm



HS-6834
300 mm



Misuratore di lunghezza per viti
Screw depth gauges, to select proper length of screw
Instruments de mesure de profondeur pour determiner la longueur de vis requise

Per viti Ø
For screw Ø
Für Schrauben Ø
Pour vis de Ø



HS-6835
165 mm

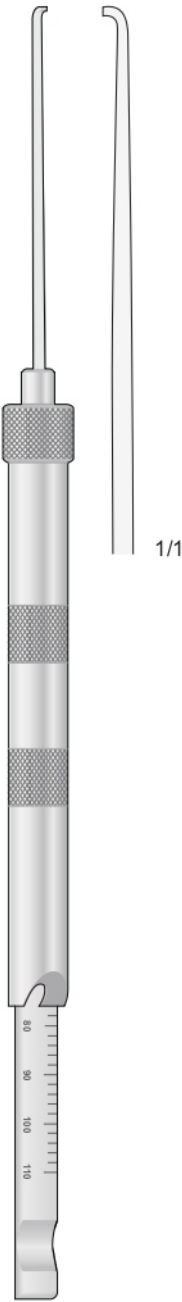

HS-6836
265 mm

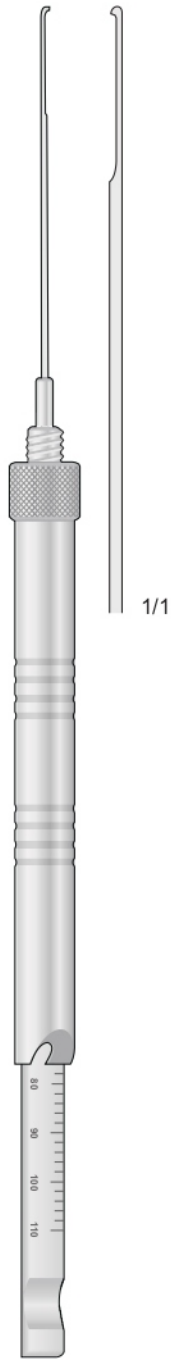

HS-6837
280 mm

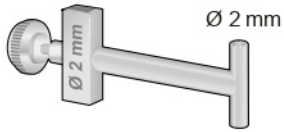

HS-6838-2

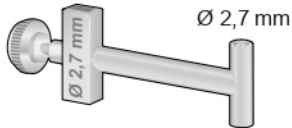

HS-6838-3

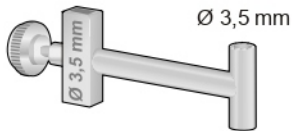

HS-6838-4

Centrapunte
Manicotto dentato
Steckbohrbüchsen
Insert-drill

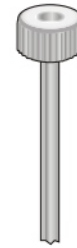

Ø Esterno Ø Per punte
Ø Outside Ø For drills
Ø Außen Ø Für Bohrer
Ø Extérieur Ø Pour Mèches
Ø Exterior Ø Para agujas

| Cod. Art. | Ø Esterno | Ø Per punte |
|-----------|-----------|-------------|
| HS-6839-1 | 4,5 mm | 3,2 mm |
| HS-6839-2 | 3,5 mm | 2 mm |
| HS-6839-3 | 3,5 mm | 2,7 mm |

Guida per punte elicoidali
Gewebeschützülzen

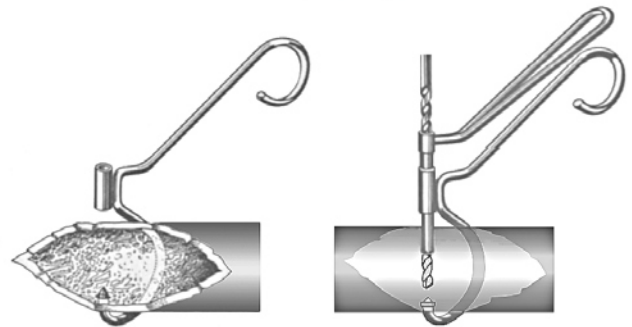

12-1940-05
Completo di 3 guide

12-1940-01
Centratore solo

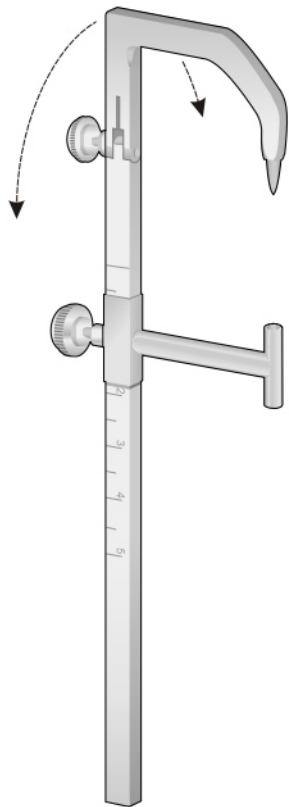

HS-6838
145 mm

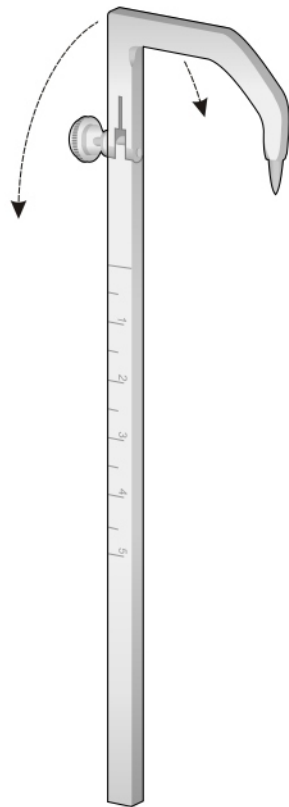

HS-6838-1
145 mm

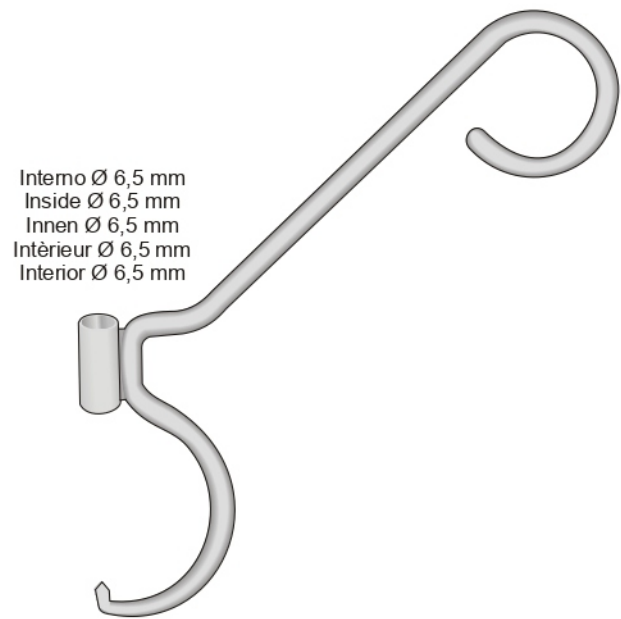

Interno Ø 6,5 mm
Inside Ø 6,5 mm
Innen Ø 6,5 mm
Intérieur Ø 6,5 mm
Interior Ø 6,5 mm

HS-6839



Attacco Dentale
Dental schaft

Ø 1,5 mm



HS-6840-9
50 mm

Ø 2,0 mm



HS-6840-10
55 mm

Attacco AO
Mit AO schaft

Ø 1,5 mm



HS-6840-1
65 mm

Ø 2 mm



HS-6840-2
70 mm

Ø 2,7 mm



HS-6840-3
100 mm

Passo della vite
a 1,25 mm

Ø 3,5 mm



HS-6840-4
110 mm

Passo della vite
a 1,75 mm

Ø 3,5 mm



HS-6840-5
110 mm

Ø 4,5 mm



HS-6840-6
130 mm

Ø 4,5 mm



HS-6840-7
130 mm

Ø 6,5 mm



HS-6840-8
170 mm

Punte elicoidali con innesto rapido

Attacco AO
Mit AO schaft
Drill bits

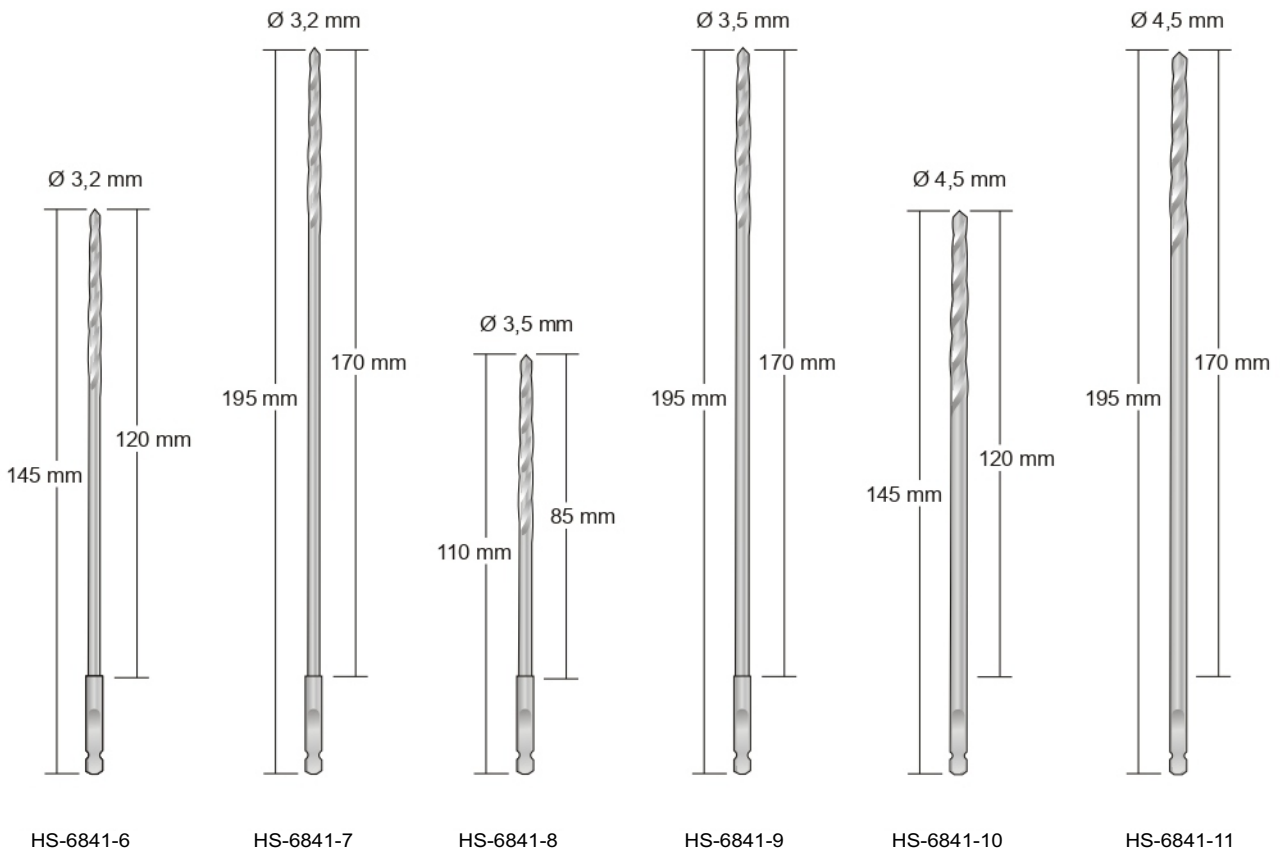
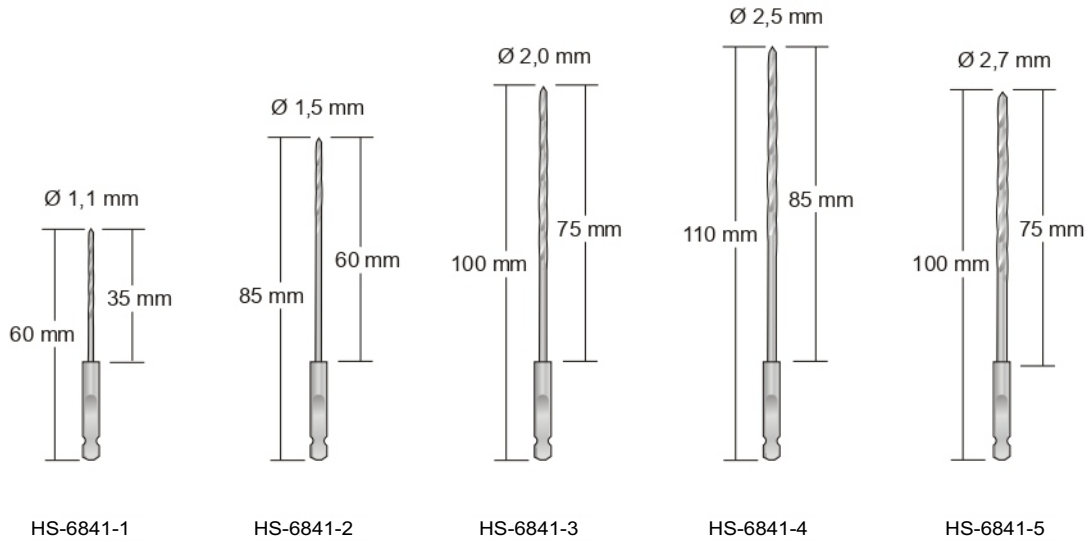

Punte elicoidali

Con attacco rotondo
Mit rundschaft
Drill bits

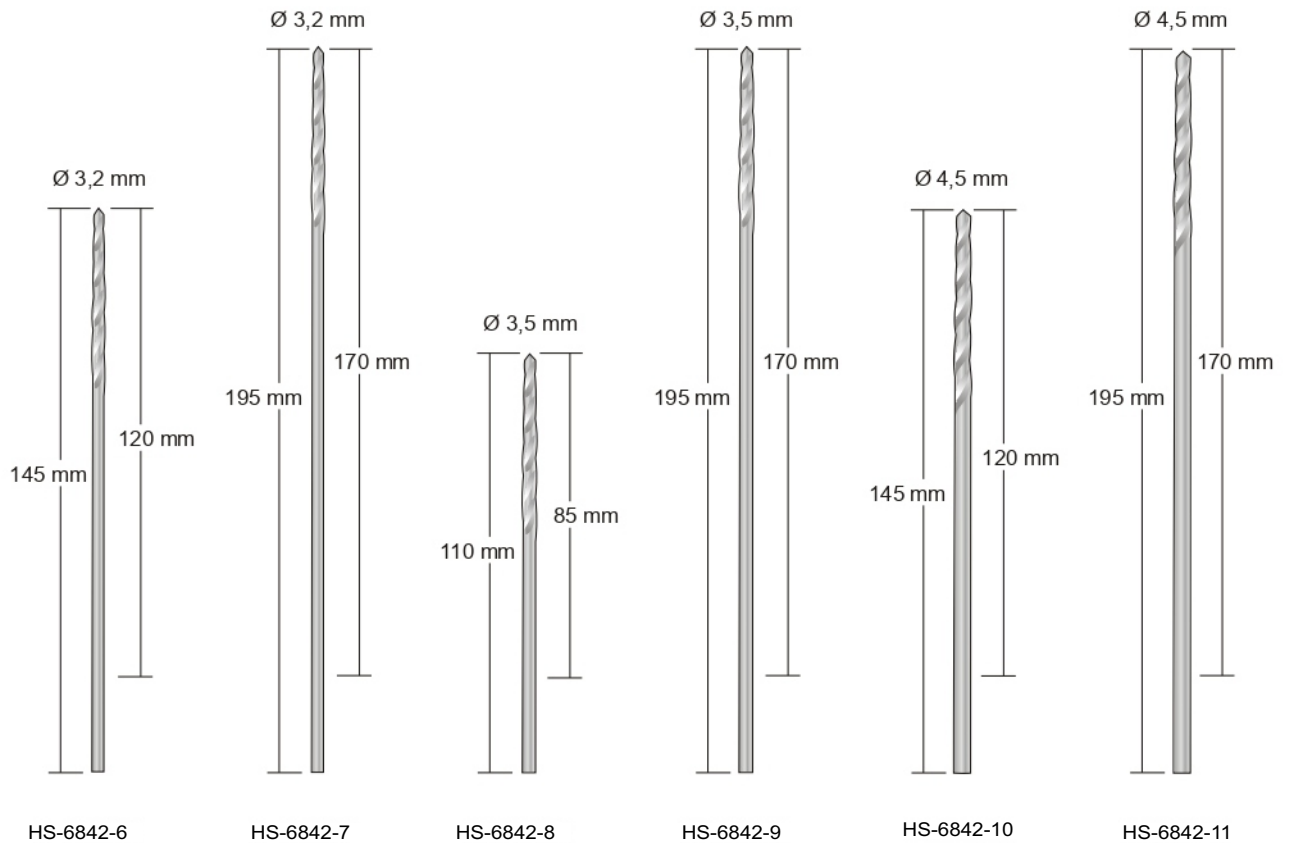
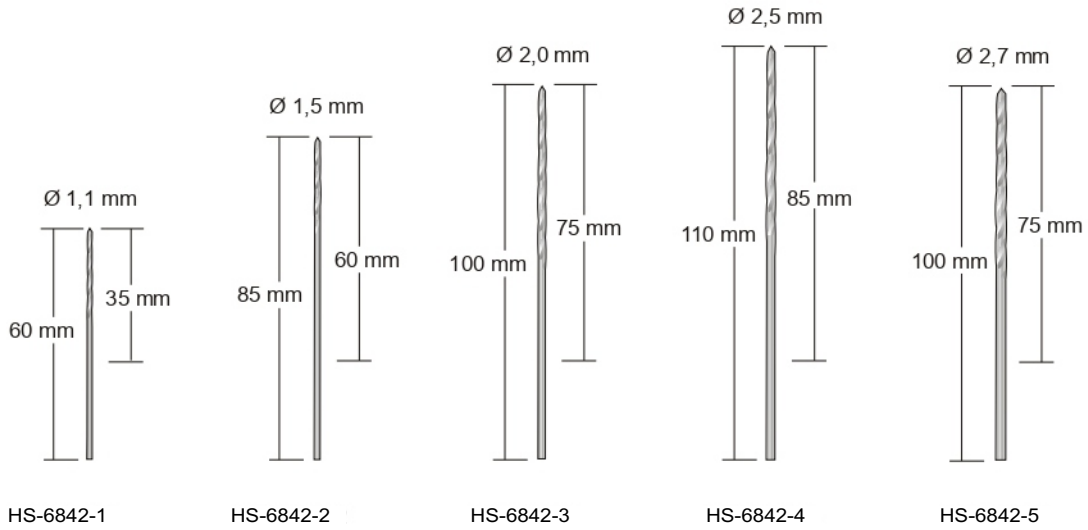

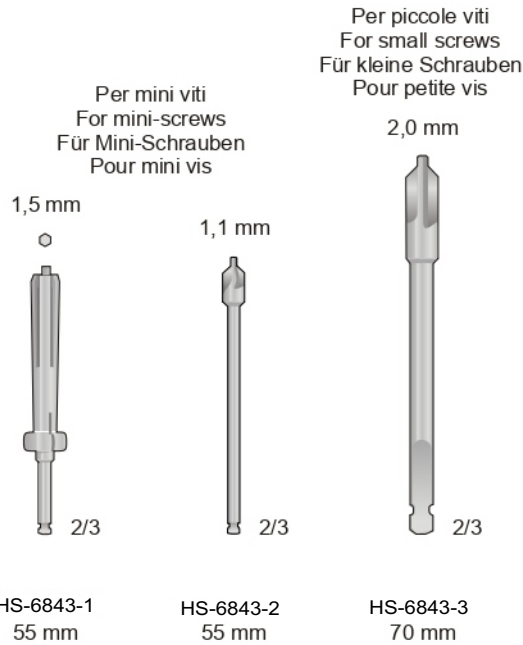

Per viti malleolari
For malleolar screws
Für Malleolarschrauben
Pour vis à malléole

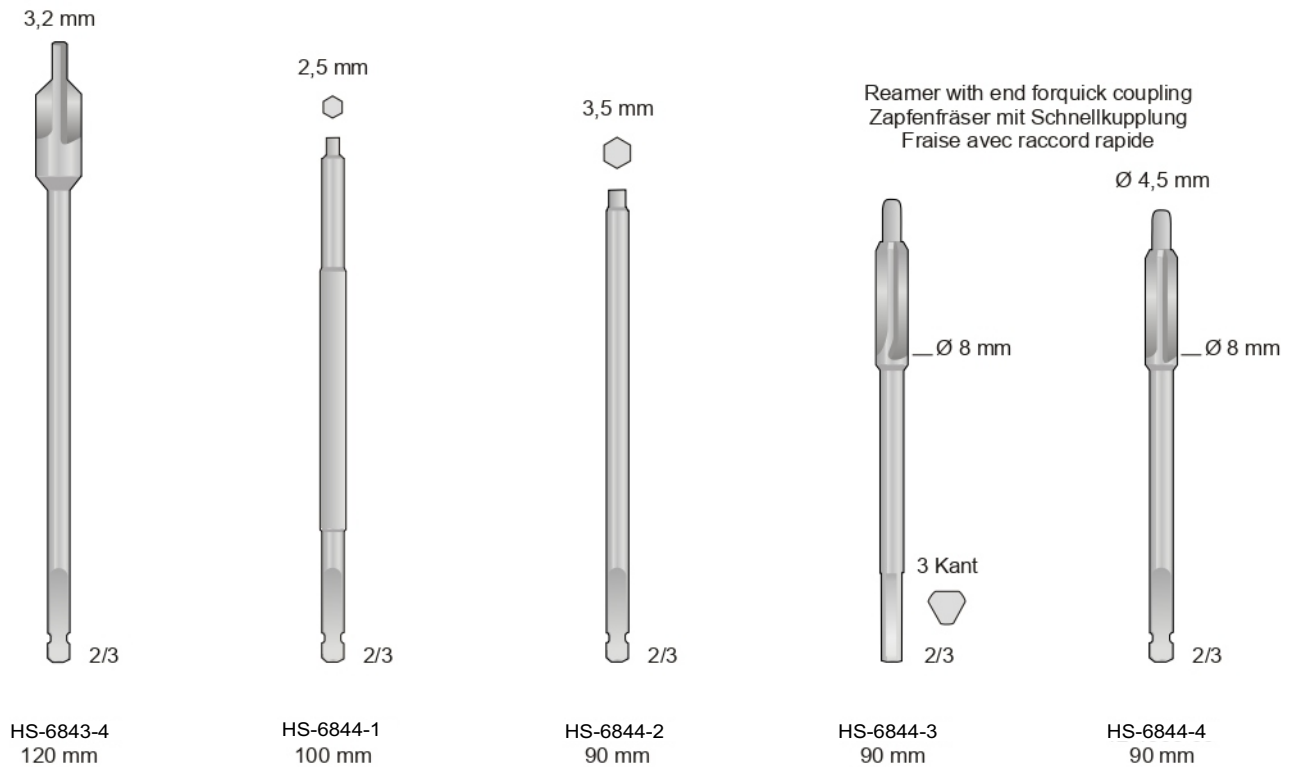

Manico con mandrino rapido
Handles with quick-action chuck
Handgriffe mit schnellspann futter
Poignées avec mandrins rapides

Ø 4 mm

AO-Schaft



Dental-Schaft



4kant-Schaft

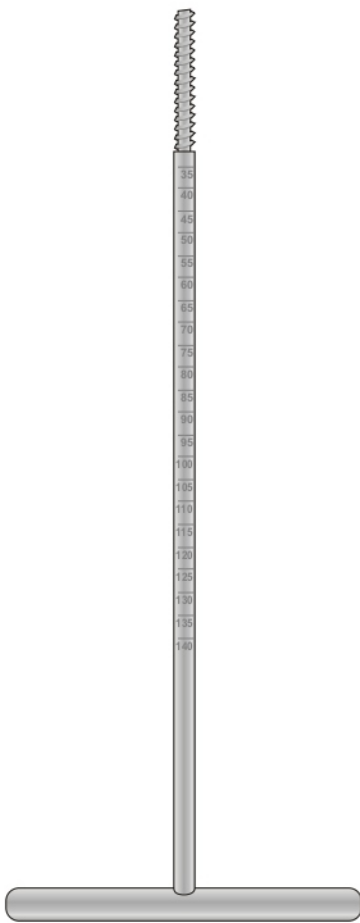

HS-6844
260 mm



MANICO FERROZELL
HS-6845
125 mm



HS-6846
110 mm

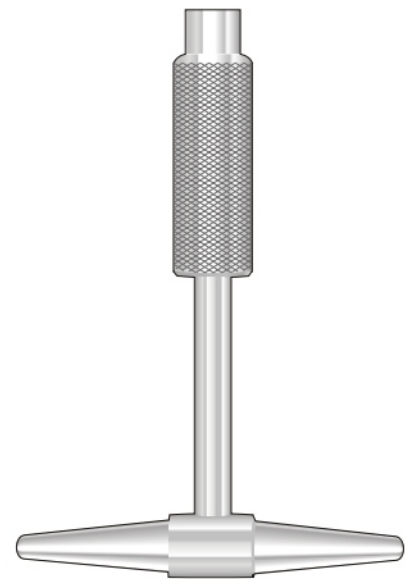

HS-6847
80 mm

Centratori guida punte - Drill guides - Bohrbüchsen zu Knochenplatten - Guide méche

Per trapano Ø 2 mm

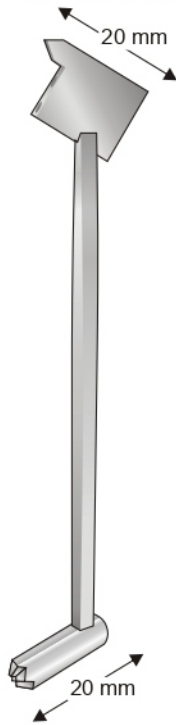

HS-6848
110 mm

Per viti da corticale Ø 3,5 mm
Per maschiatore Ø 2,5 mm



HS-6849

Per viti da corticale
Ø 6,5 mm
Per maschiatore
Ø 3,2 mm



HS-6850

Per trapano Ø 1,1/1,5 mm

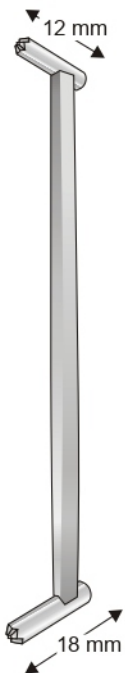

HS-6851
105 mm

Per trapano Ø 2,5 mm
Per viti da corticale Ø 3,5 mm
Per maschiatore Ø 3,5 mm

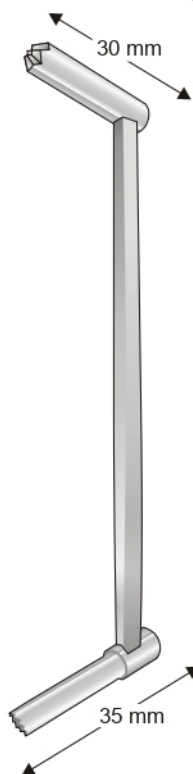

HS-6852
125 mm

Per viti da corticale Ø 4,5 mm
Per maschiatore Ø 3,2 mm

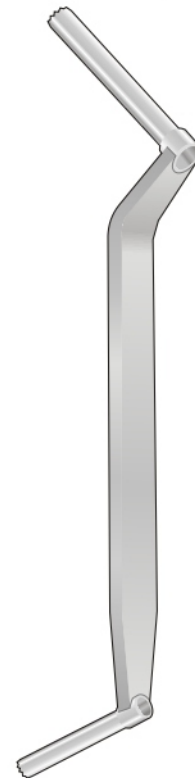

HS-6853

Centratori guida punte - Drill guides - Bohrbüchsen zu Knochenplatten - Guide méche

Codificazione del colore

verde = centrico
oro = eccentrico

Per trapano Ø 2,0 mm
Per viti da corticale Ø 2,7 mm

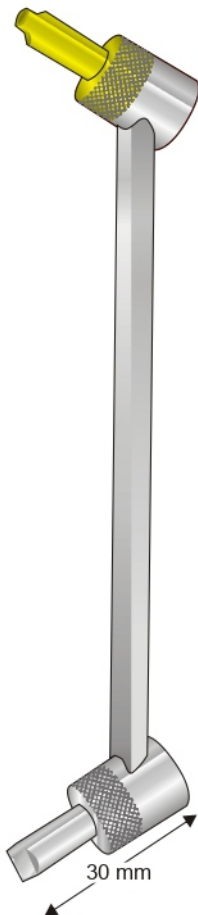

HS-6854
140 mm

Per trapano Ø 2,5 mm
Per viti da corticale Ø 3,5 mm

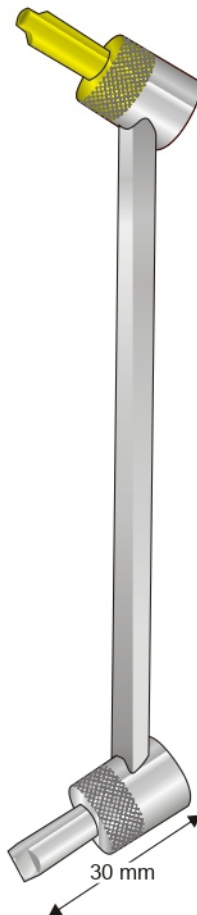

HS-6855
140 mm

Per trapano Ø 3,2 mm
Per viti da corticale Ø 4,5 mm

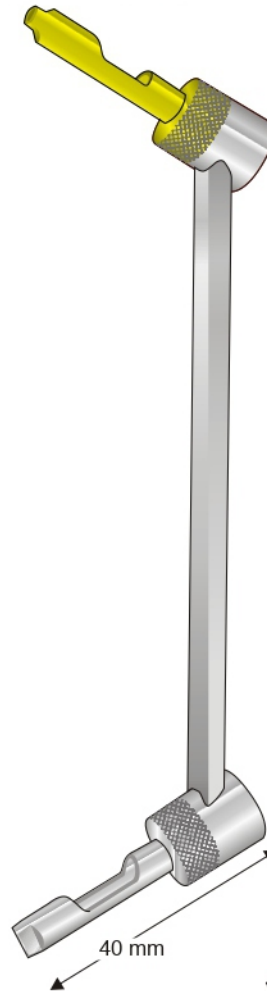

HS-6856
165 mm

Per trapano Ø 3,2 mm
Per viti da corticale Ø 4,5 mm

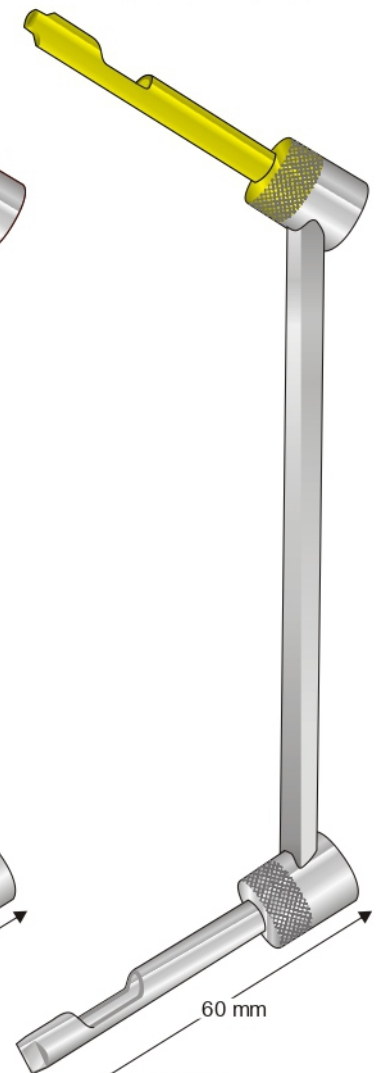

HS-6857
170 mm



Centratori guida punte - Drill guides - Bohrbüchsen zu Knochenplatten - Guide méche

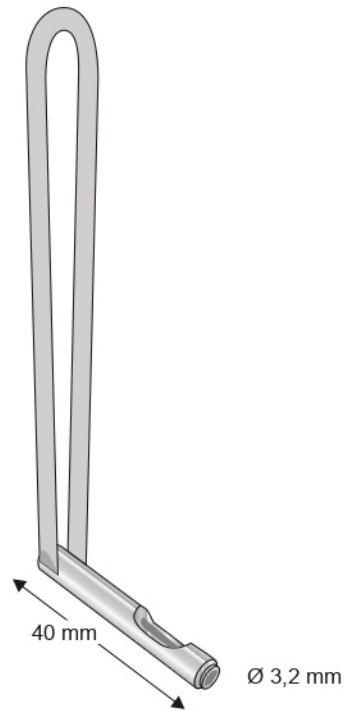

HS-6858-1
125 mm

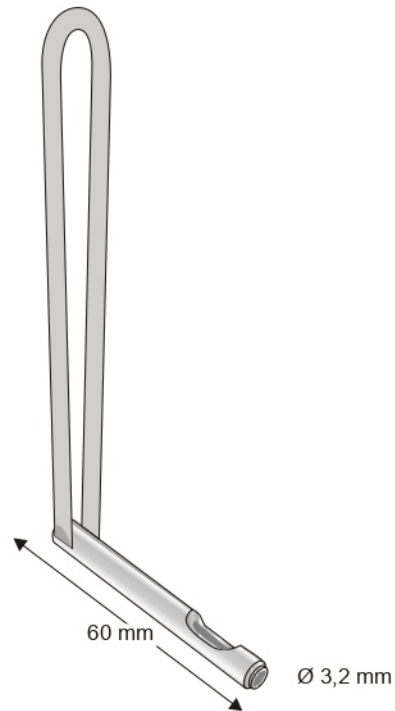

HS-6858-2
125 mm

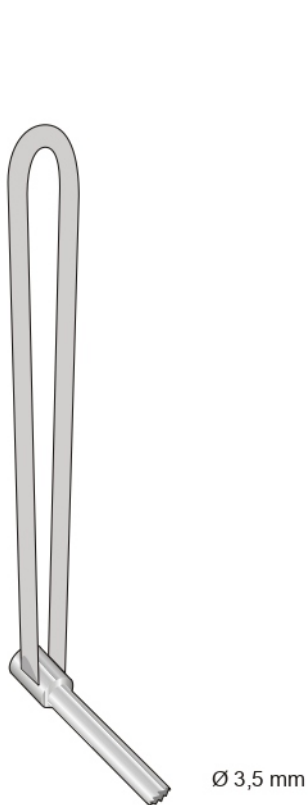

HS-6858-3
125 mm

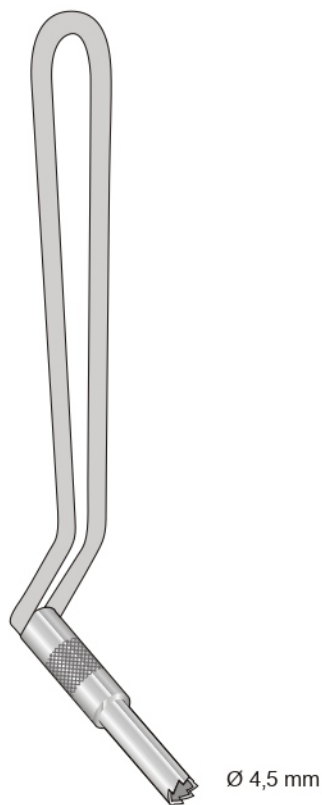

HS-6858-4
150 mm

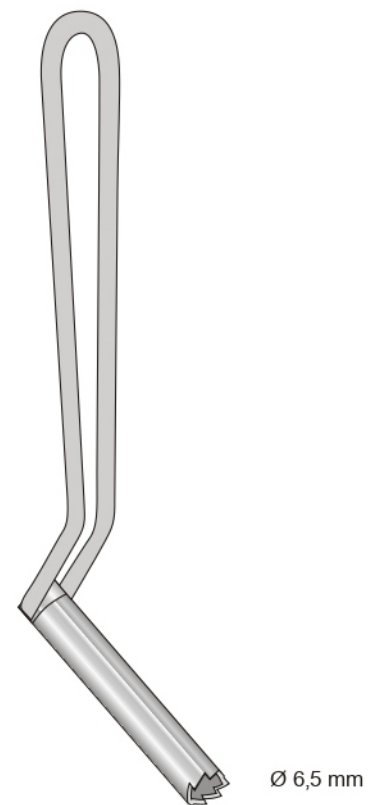

HS-6858-5
150 mm

Scatola con set giraviti - Box with screws driver - Schraubenzieher, Set mit Etui
Jeu de tournevis, en boîte - Set destornilladores

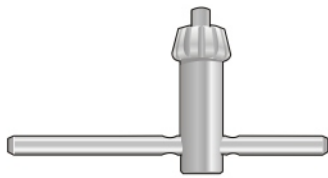
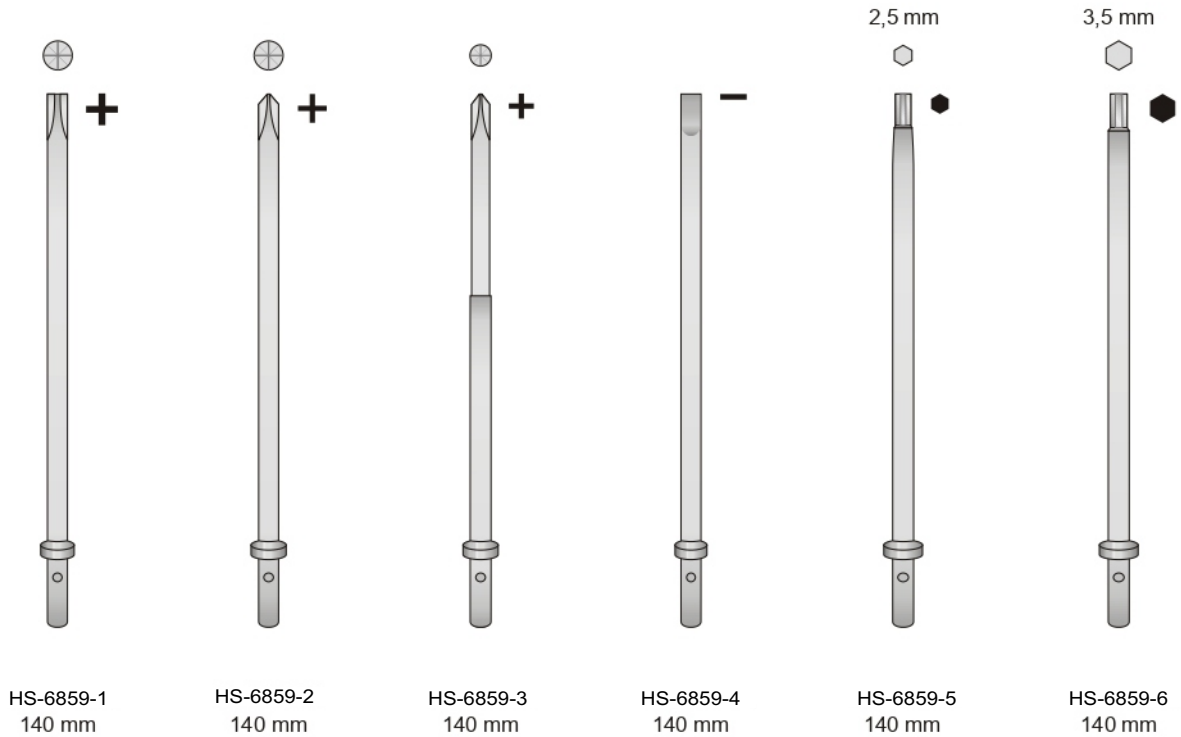

HS-6860
32 mm

Scatola con set giraviti - Completo
Box with screws driver - Complete
Schraubenzieher, Set mit Etui - Komplett
Jeu de tournevis, en boîte - Complete
Set destornilladores - Completos

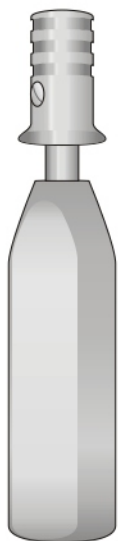

HS-6861
145 mm

Max. Ø 6,3 mm

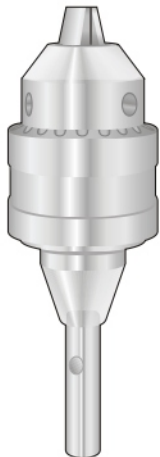

UNIVERSAL
HS-6862
75 mm

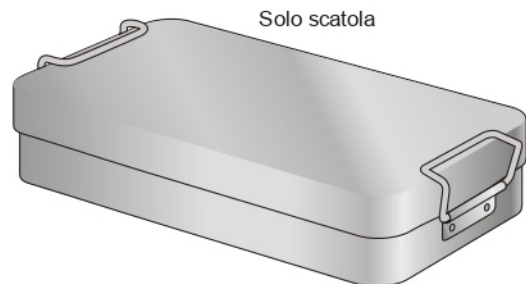

Solo scatola

HS-6863
200x100x40 mm

Giraviti - Screws driver - Schraubenzieher - Jeu de tournevis - Destornilladores

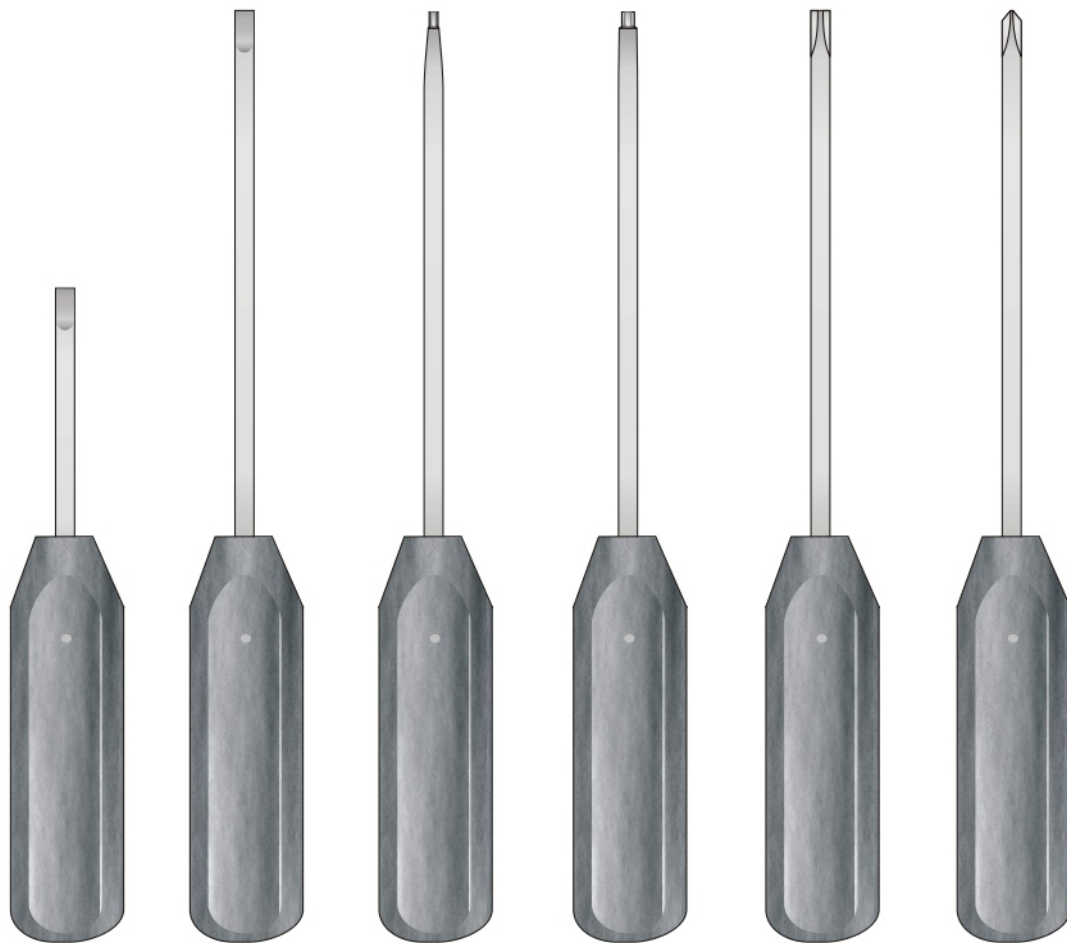
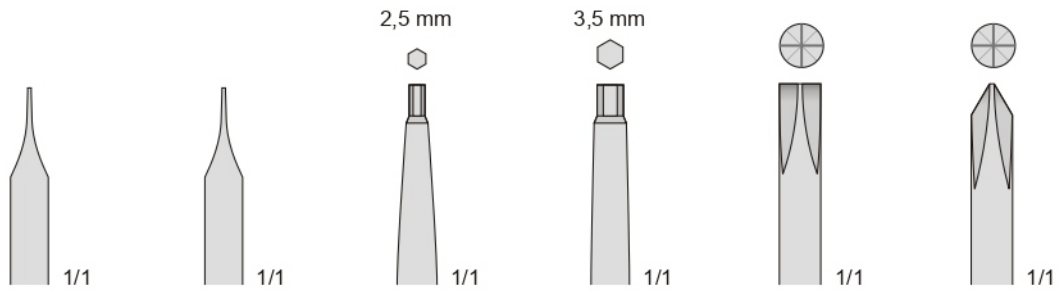

HS-6864-1
170 mm

LANE
 HS-6864-2
 250 mm

HS-6864-3
 250 mm

HS-6864-4
 250 mm

HS-6864-5
 250 mm

PHILIPS
 HS-6864-6
 250 mm

Giraviti - Screws driver - Schraubenzieher - Jeu de tournevis - Destornilladores

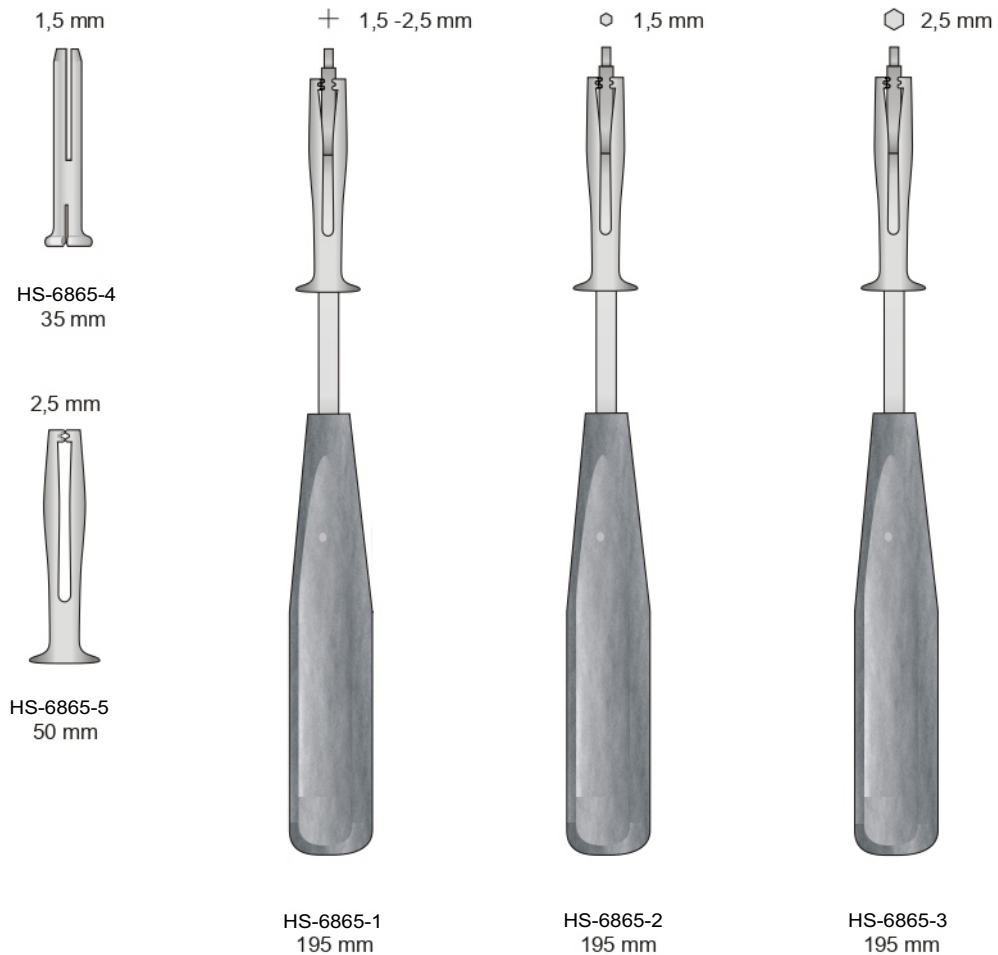

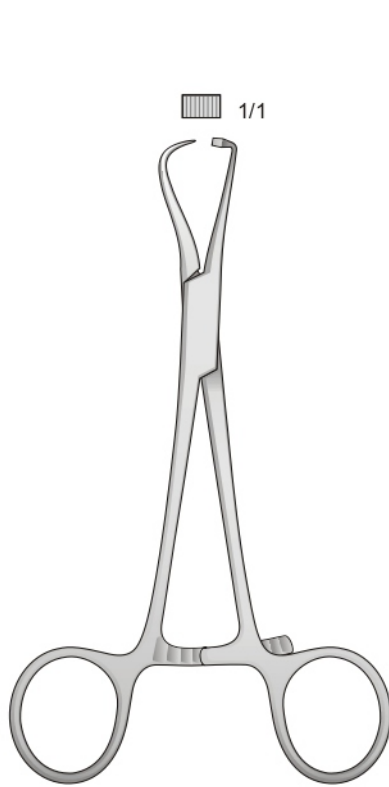

HS-6866
120 mm

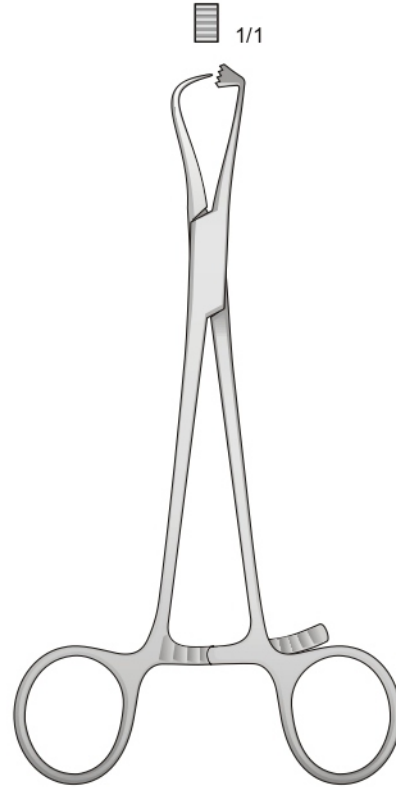

HS-6867
125 mm

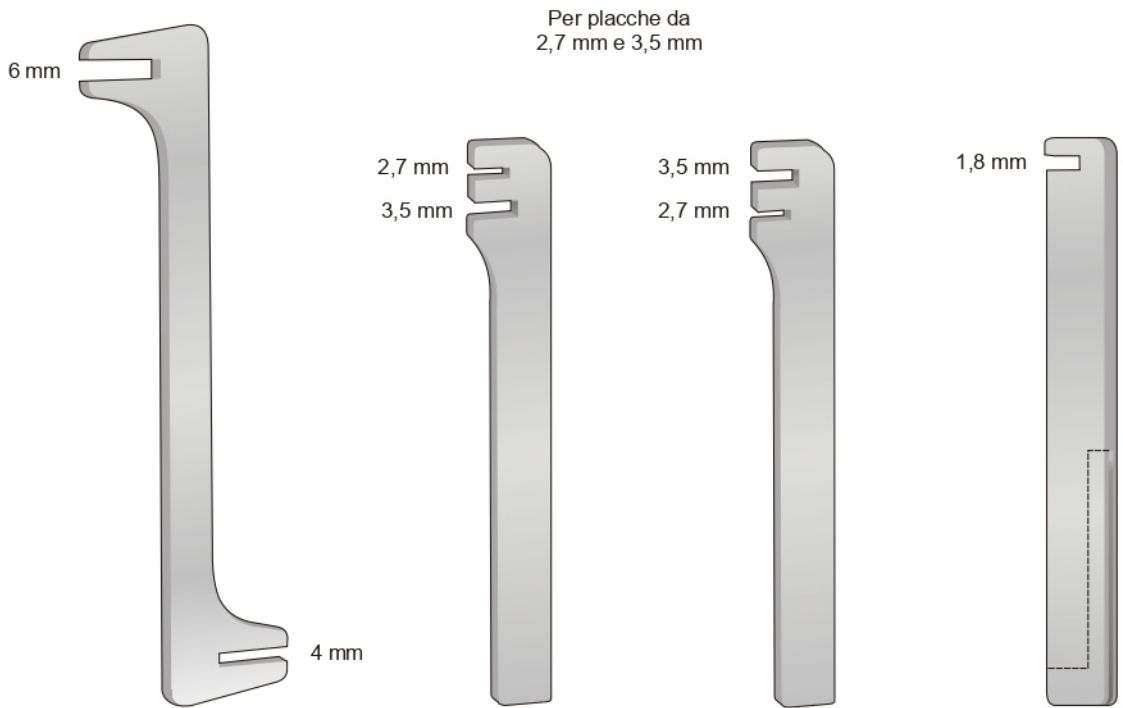

Per placche da
2,7 mm e 3,5 mm

HS-6868
180 mm

HS-6868-1 100 mm
HS-6868-2 140 mm

HS-6868-3 100 mm
HS-6868-4 140 mm

HS-6868-5
100 mm

Pinze piegaplacche - Bending pliers - Biegezange - Pincés à plier

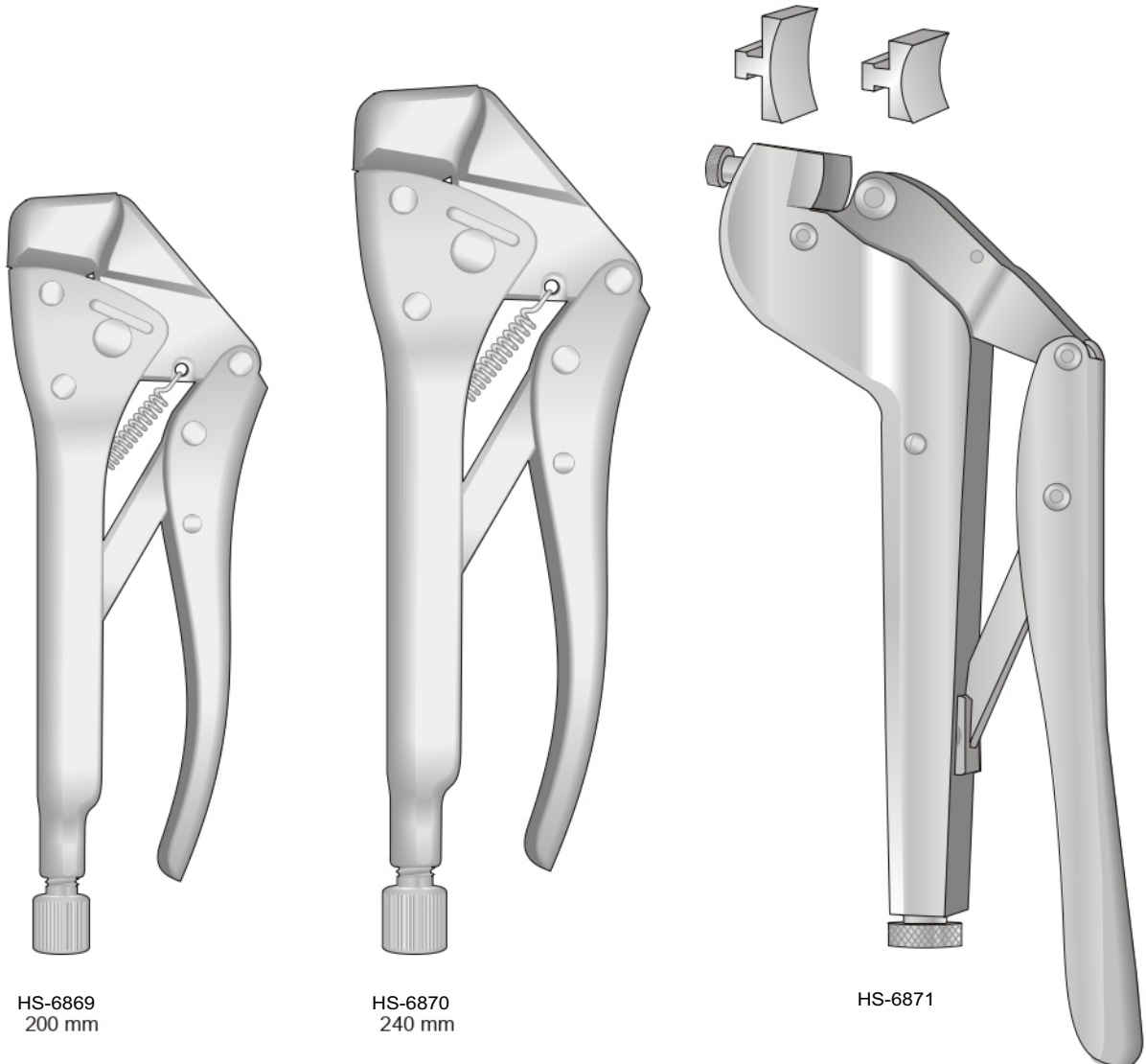

Pressa piegaplacche - Bending press - Biegepresse - Presse pour plier

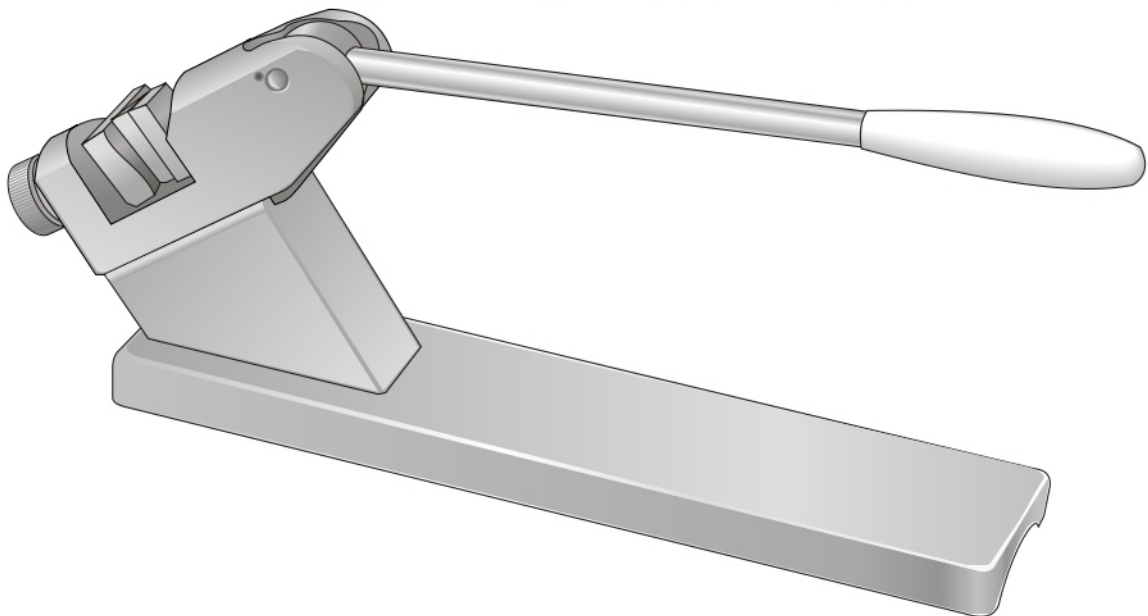

HS-6872

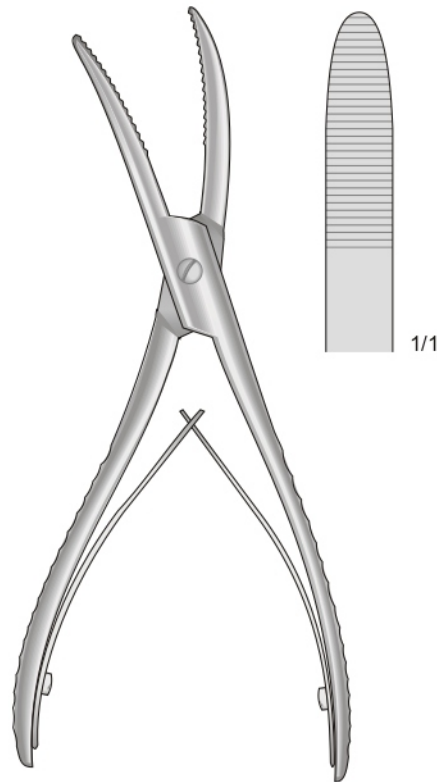

WOLFF
 HS-6873
 180 mm

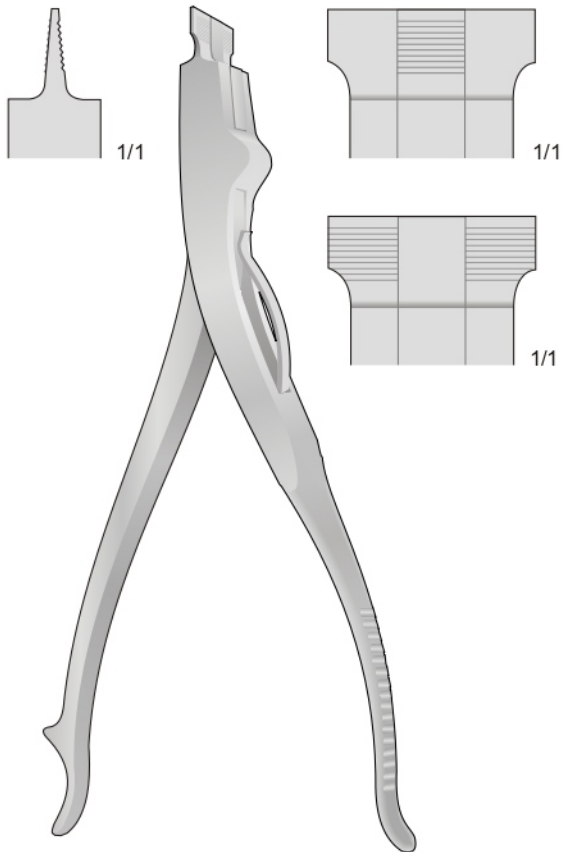

LAWTON
 HS-6874
 220 mm

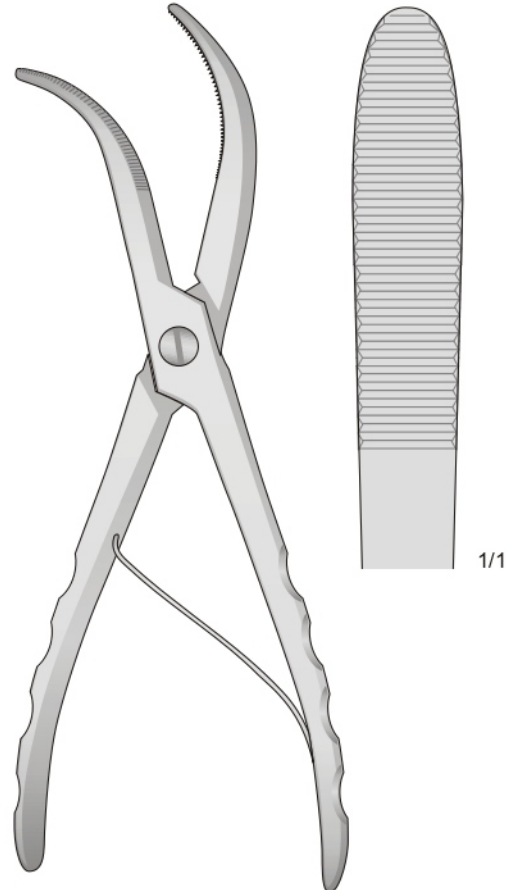

WOLFF
 HS-6875
 250 mm



Cesoie per gesso
Gips - Schneidezangen

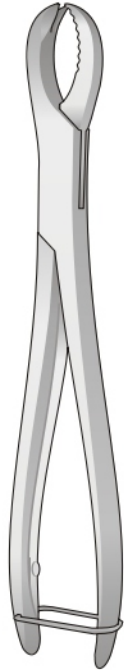

1/1

HS-6876
210 mm

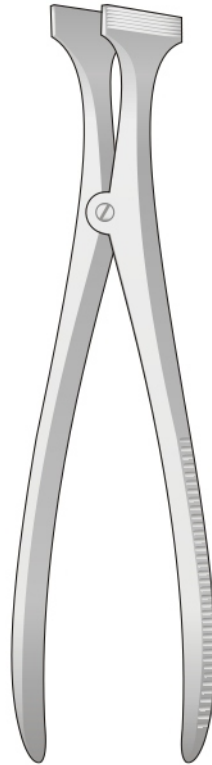

HENNIG
HS-6877
270 mm

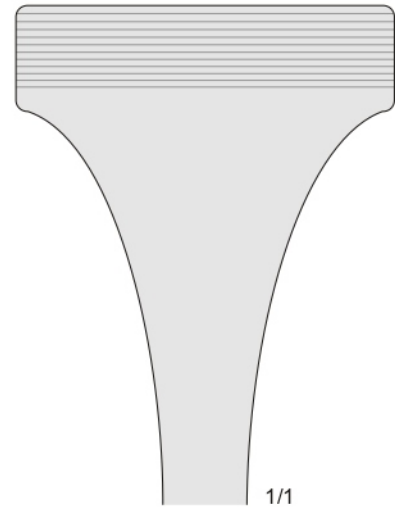

1/1

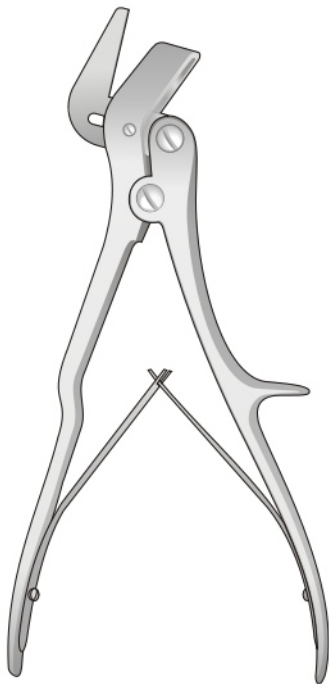

STILLE
HS-6878
230 mm

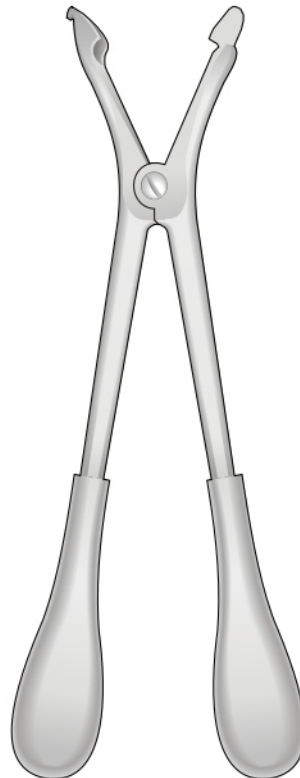

HAGLUND
HS-6879
280 mm

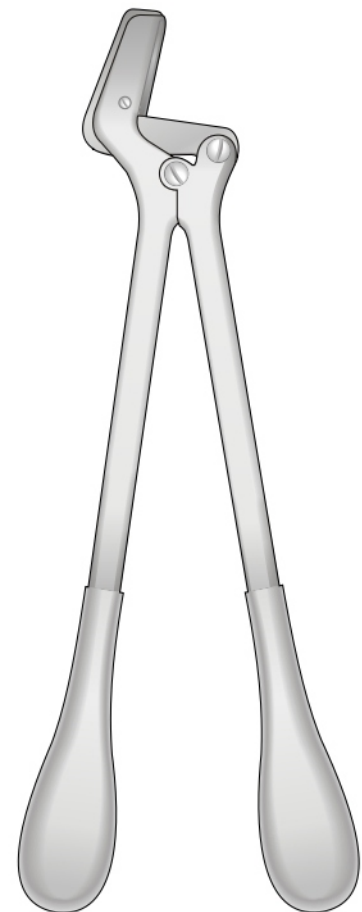

STILLE
HS-6880
370 mm

**Manufacturer & Exporter
Of Surgical, Dental & Beauty Instruments.**



Health Fast Surgical

Surgical Manufacturer Company

+92 (342) 880 9017

+92 (342) 880 9017

info@healthfastsurgical.com

www.healthfastsurgical.com

Dogra Khurd, P.O Harrar Sialkot-51310 Pakistan.



ISO
9001:2008

