

Atraumatic Vascular Clamps

Surgical
INSTRUMENTS CATALOGUE



www.healthfastsurgical.com



Health Fast Surgical
Surgical Manufacturer Company



Atraumatiche - Atraumatic
Atraumatische - Atraumatiques - Atraumáticas

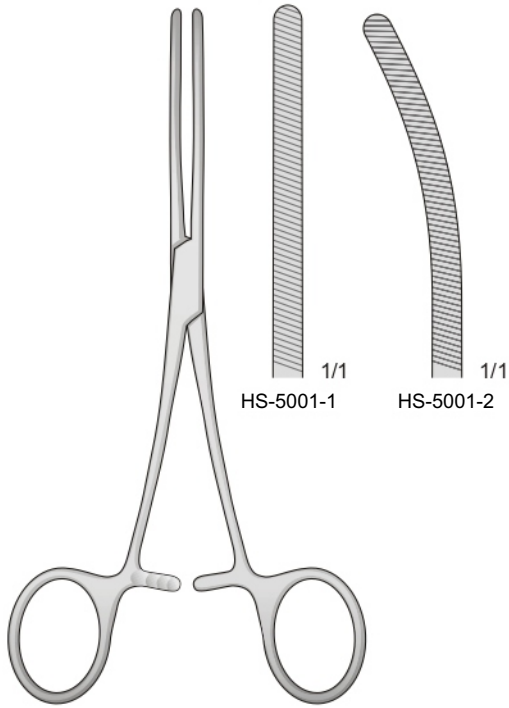

DOYEN
HS-5001
170 mm

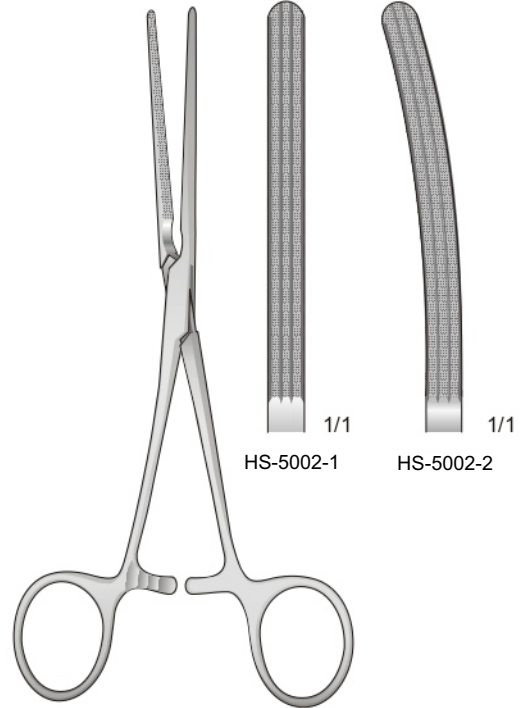

DOYEN
HS-5002
170 mm

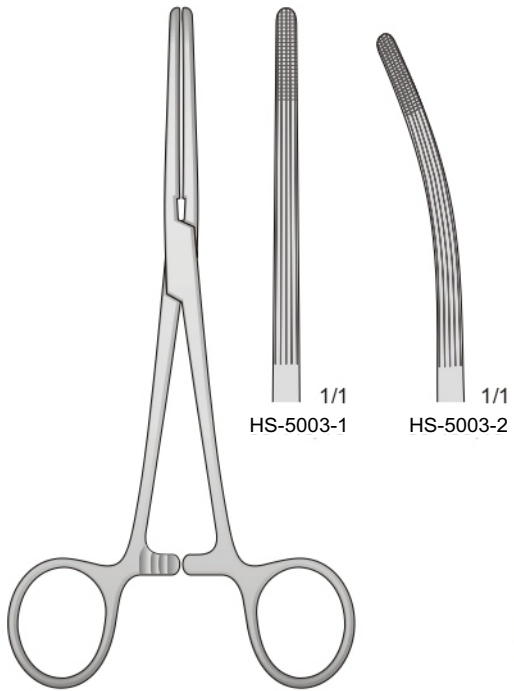

ROCHESTER-CARMALT
HS-5003
160 mm

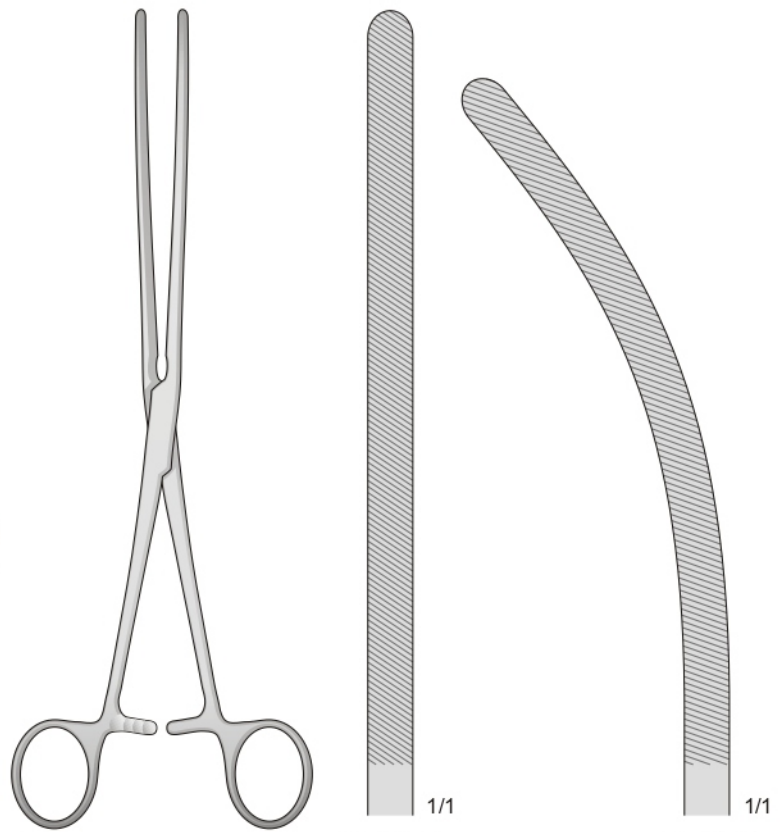

DOYEN
HS-5004
230 mm

Intestinal Clamps Soft Elastic

Elastiche - Elastisch - Elastich - Elastic - Elasticas

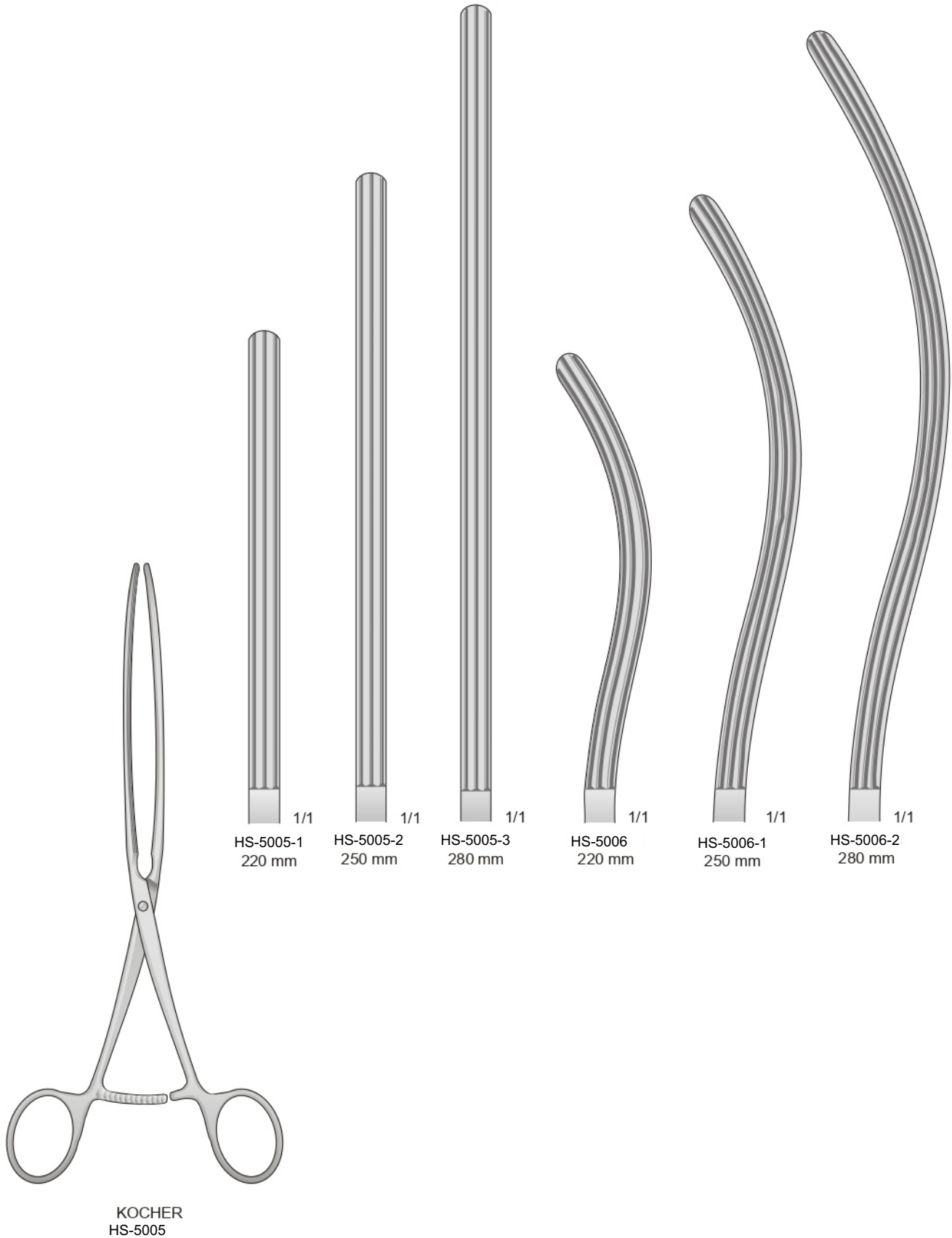

Intestinal Clamps Soft Elastic

Atraumatische - Atraumatic
 Atraumatische - Atraumatiques - Atraumáticas

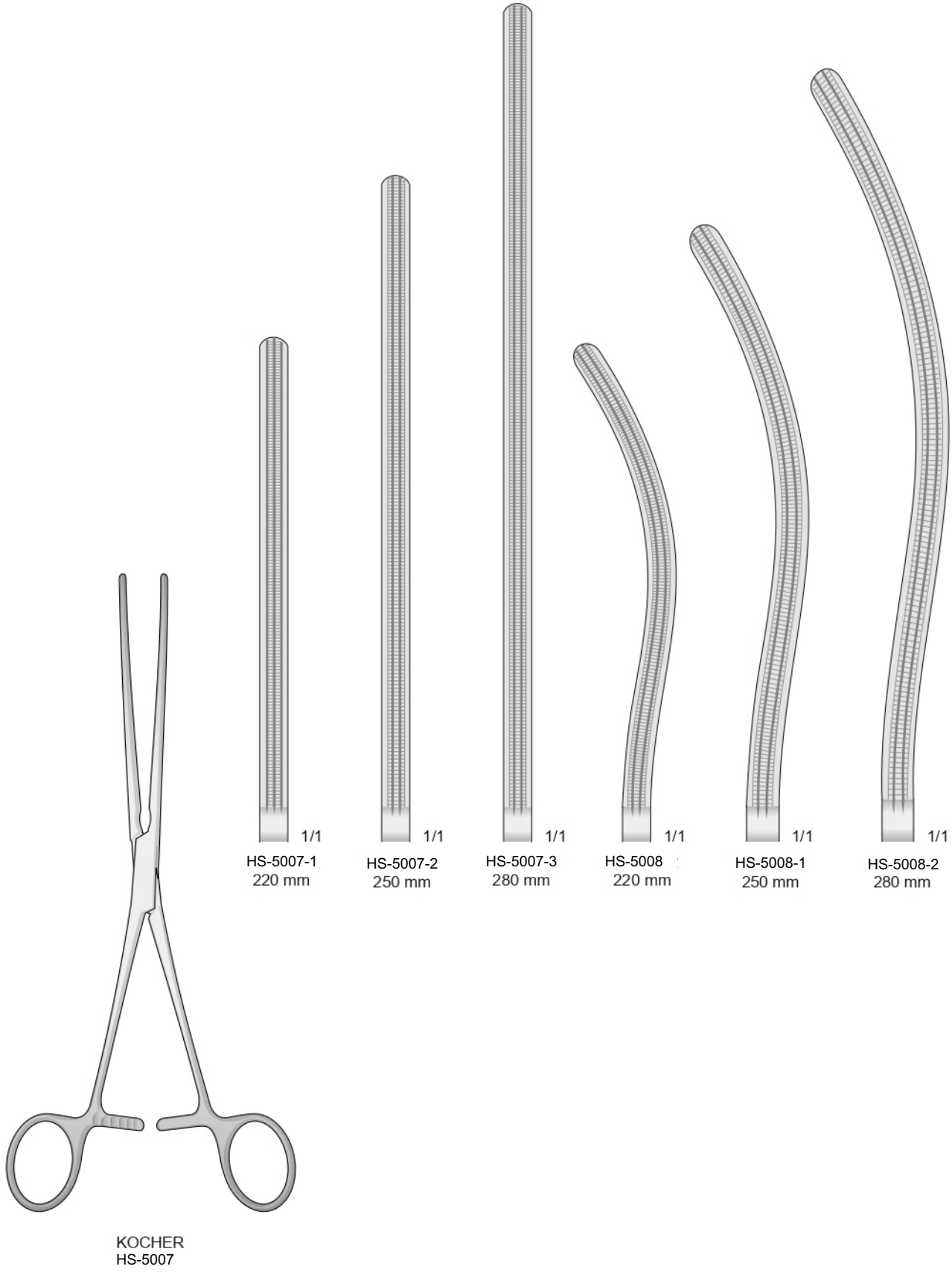

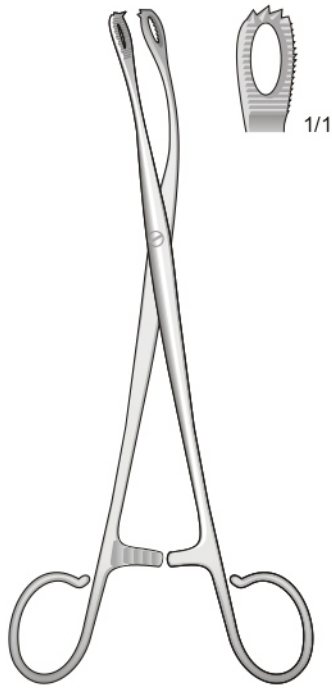

1/1

BLOHMKE
HS-5011
200 mm

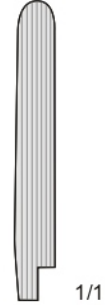
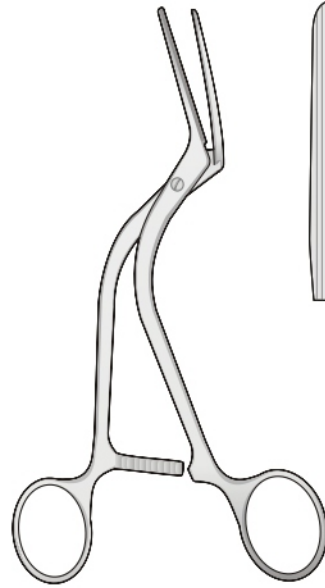

1/1

HÖPFNER
HS-5012
165 mm

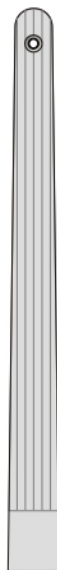
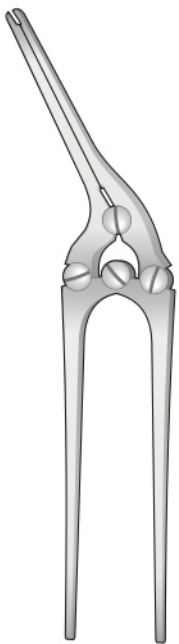

1/1

PAYR
HS-5009
200 mm

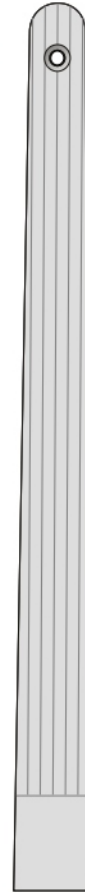

1/1

PAYR
HS-5010
280 mm

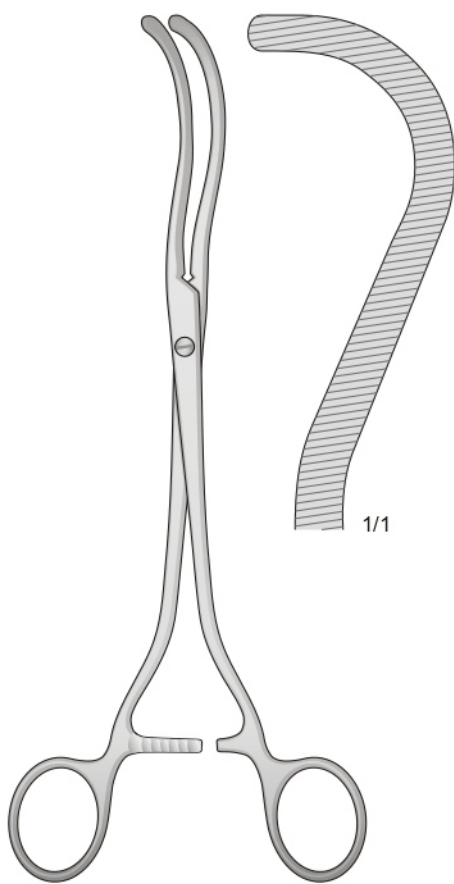

GUYON
HS-5013
235 mm

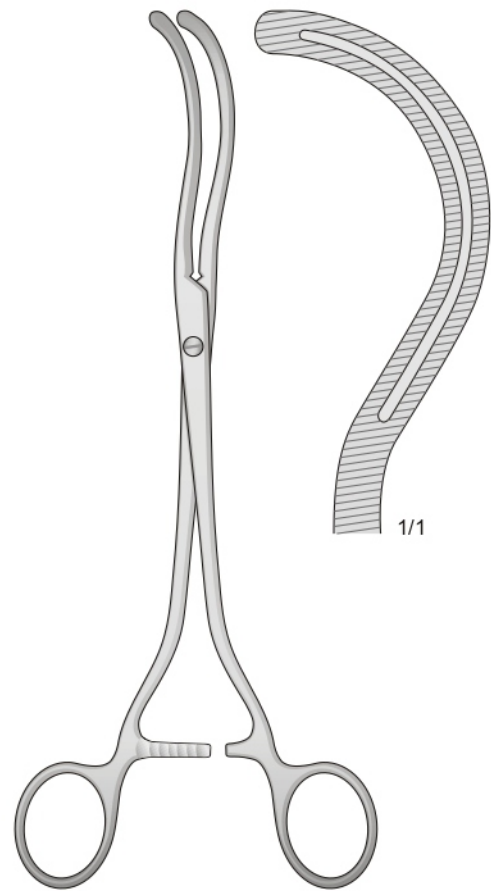

STILLE
HS-5014
240 mm

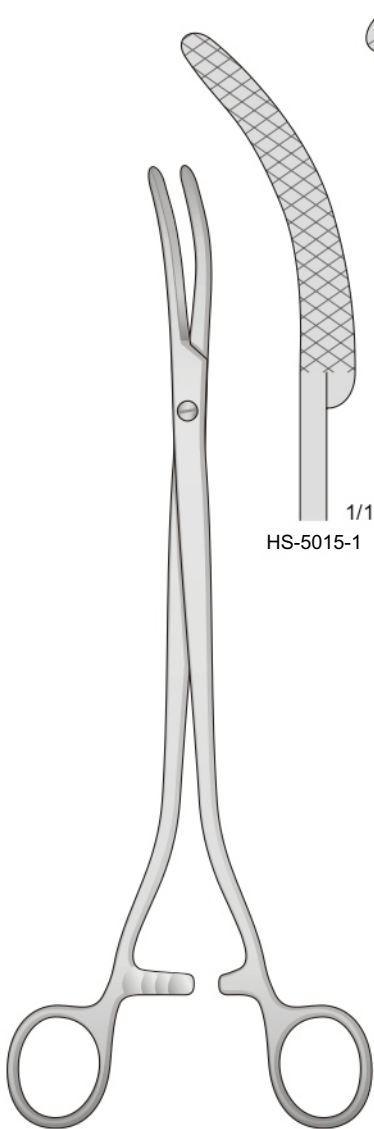

WERTHEIM
HS-5015
260 mm

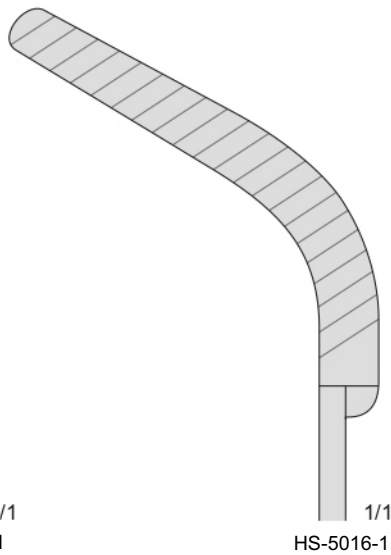

WERTHEIM
HS-5016
235 mm

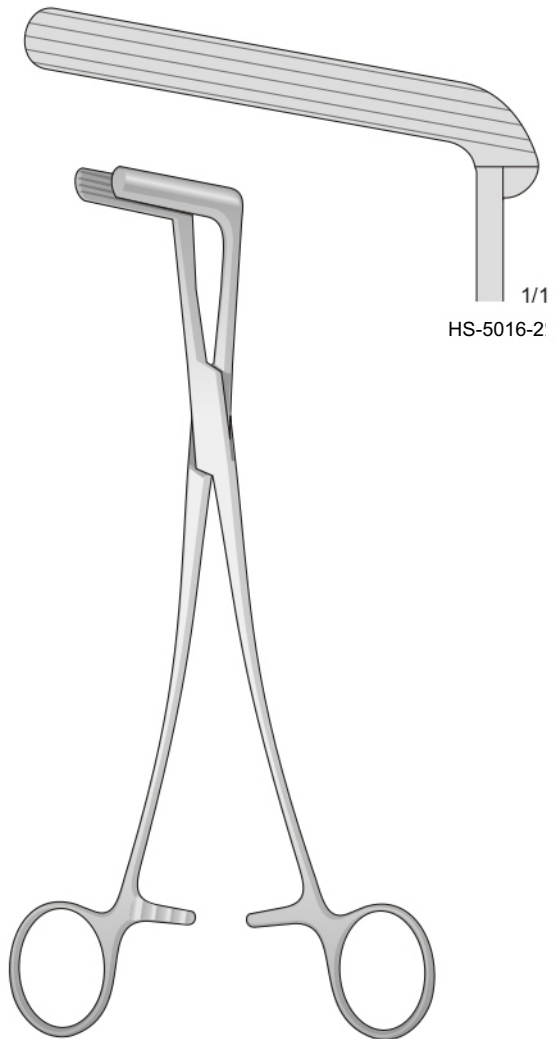

HS-5016-2
1/1



HS-5024-1
35 mm

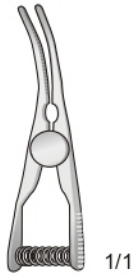

HS-5025-1
35 mm

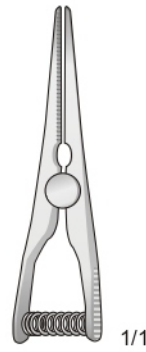

HS-5024-2
45 mm

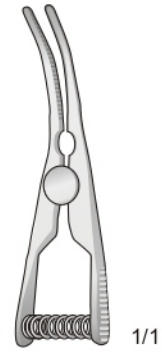

HS-5025-2
45 mm

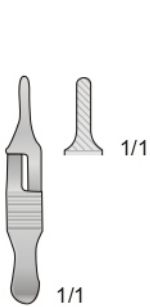

HS-5020
30 mm

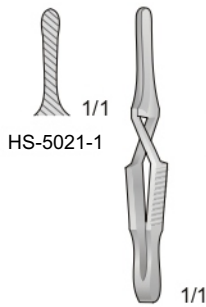

DIFFENBACH
HS-5021
40 mm

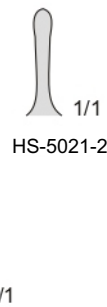

HS-5021-2

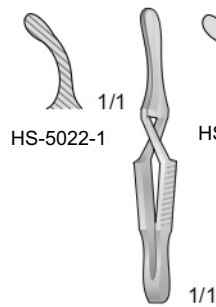

DIFFENBACH
HS-5022
40 mm

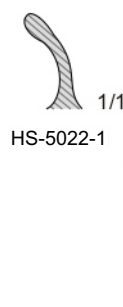

HS-5022-1

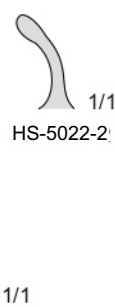

HS-5022-2

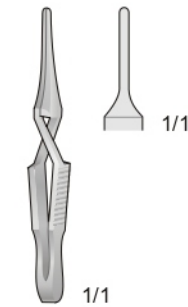

HS-5023-1
40 mm

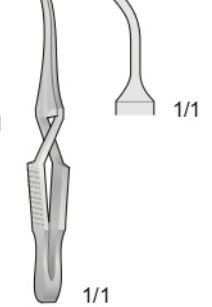

HS-5023-2
45 mm

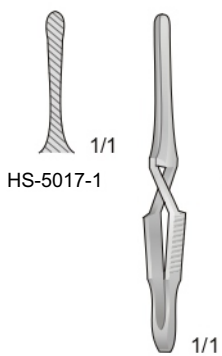

DIFFENBACH
HS-5017
45 mm

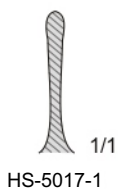

HS-5017-1

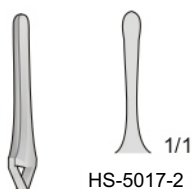

HS-5017-2

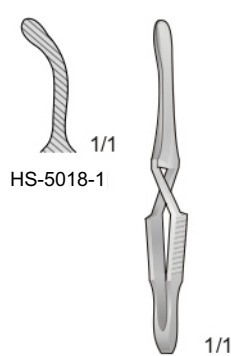

DIFFENBACH
HS-5018
45 mm

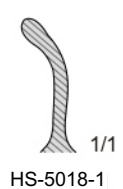

HS-5018-1

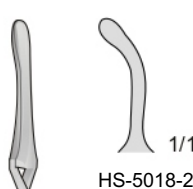

HS-5018-2

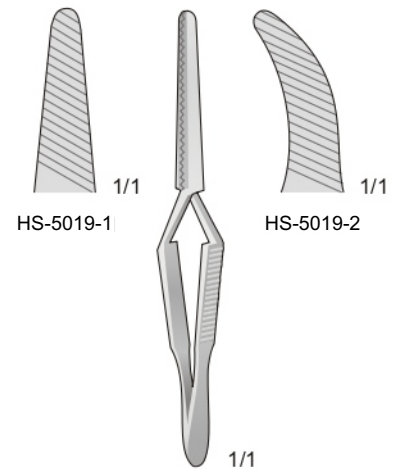

DIFFENBACH
HS-5019
60 mm

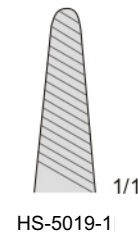

HS-5019-1

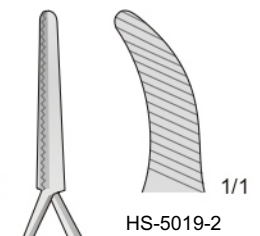

HS-5019-2

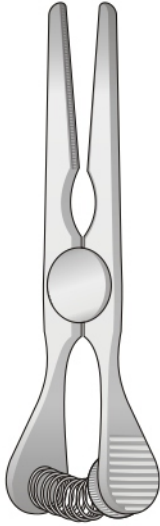

GLOVER
HS-5027

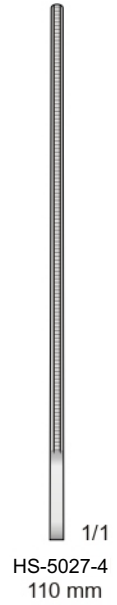
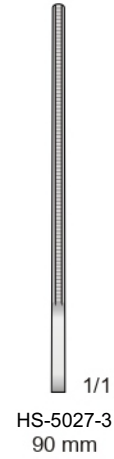

GLOVER
HS-5026

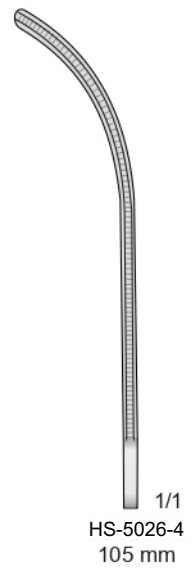
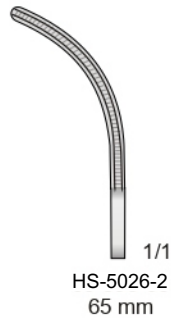
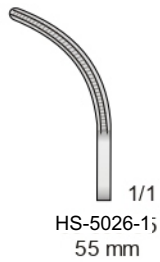



Atrauma Bulldog Clamps



HS-5030

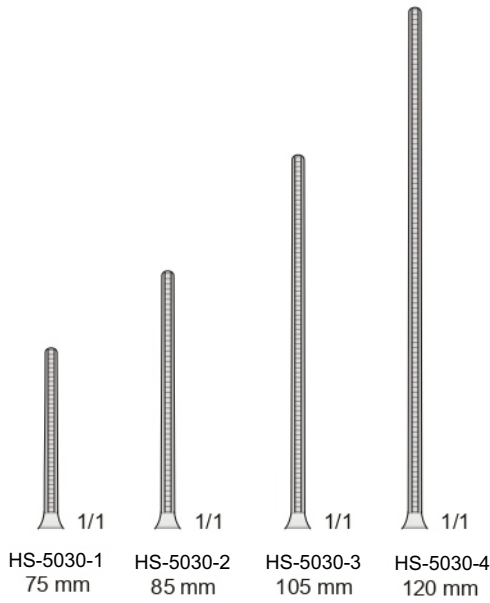

Pinza per applicare e rimuovere Bulldog clamps
Zange zum ansetzen der Bulldogklemmen
Forceps for applying and removing Bulldog clamps
Pinces pour applicateur clamps Bulldog
Pinzas de aplicación para pinzas Bulldog



HS-5028

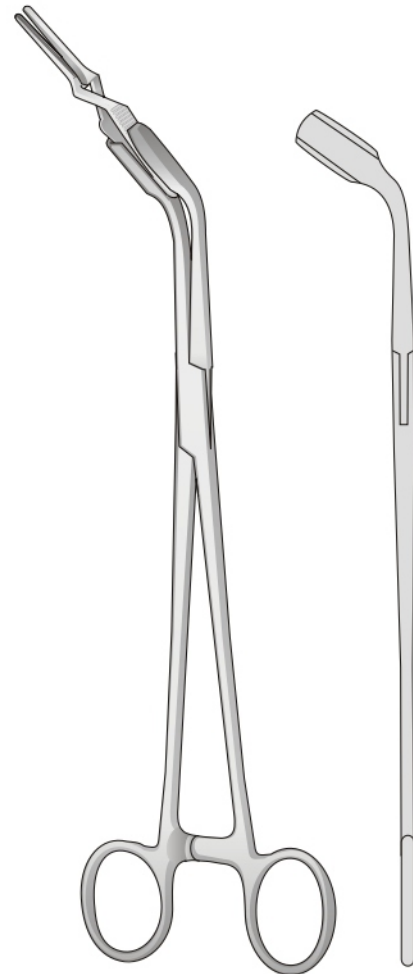
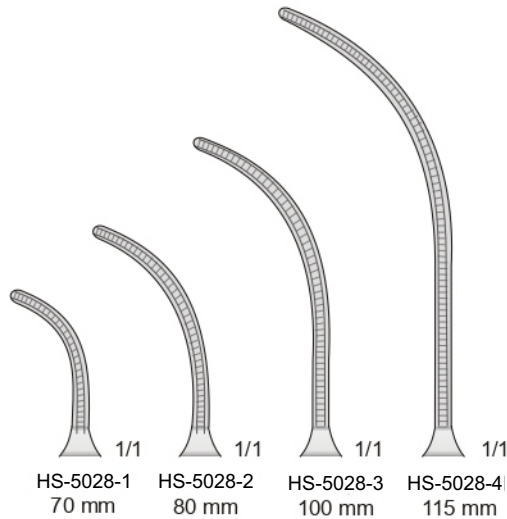

HS-5029
230 mm

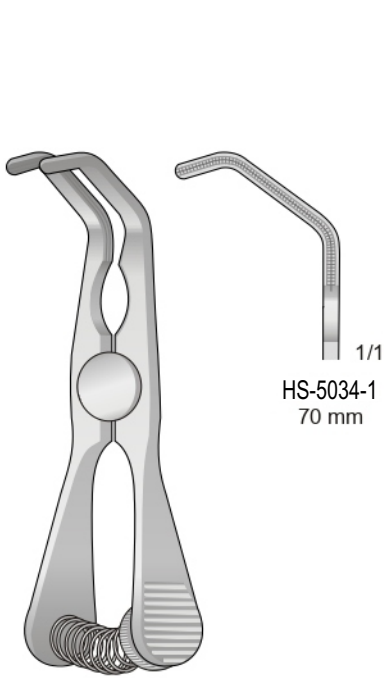

DE BAKEY-SATINSKY
 HS-5034
 70 mm

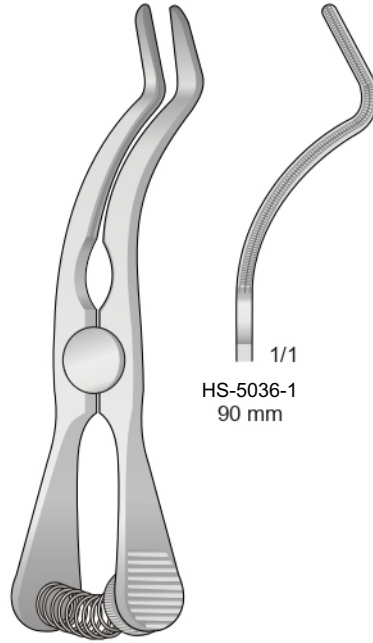

DE BAKEY-CAROTIS
 HS-5036
 90 mm

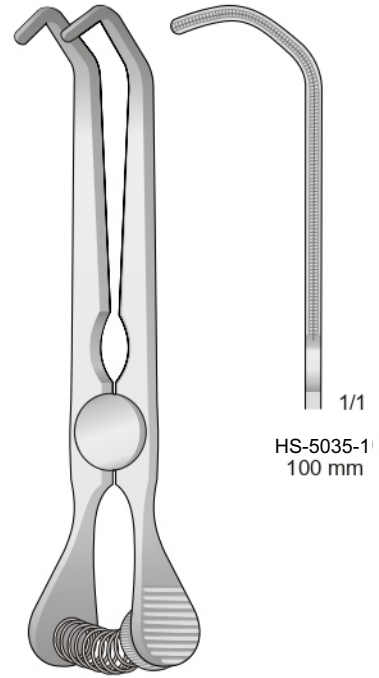

DE BAKEY-SATINSKY
 HS-5035
 100 mm

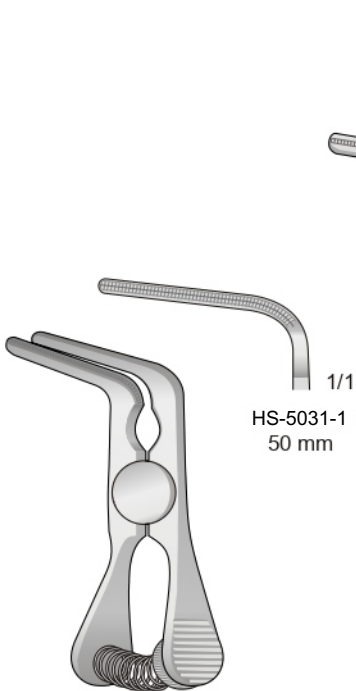

GLOVER
 HS-5031
 50 mm

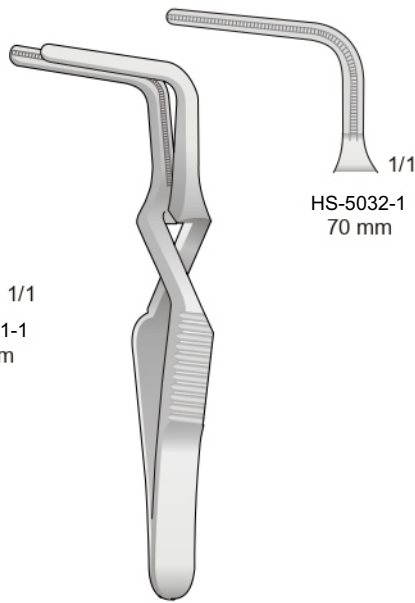

SANTULLI
 HS-5032
 70 mm

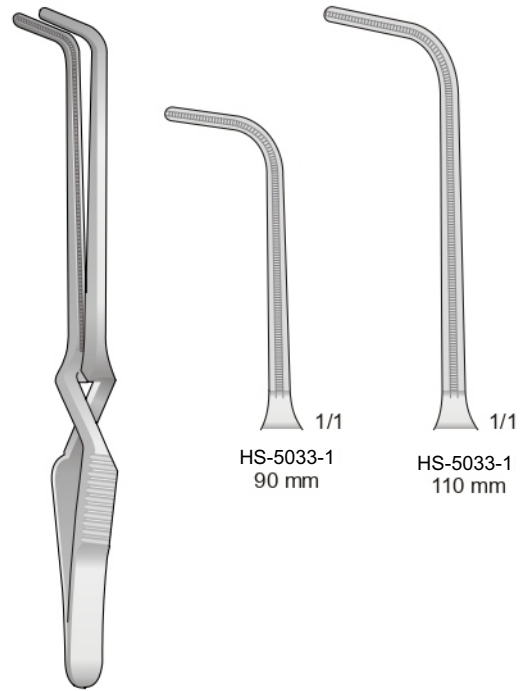

06-460

HS-5033-1
 90 mm

HS-5033-1
 110 mm



Atraumatic Vessel Clamps

Pinze atraumatiche per neonati e bambini
Atraumatic Vessel clamps for babys and children
Atraumatische Gefäßklemmen für Säuglinge und Kinder
Pincas vasculares atraumáticas para niños

Modelli estremamente fini
Delicate - Fein - Fins - Finas

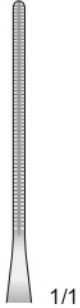

HS-5037-1
140 mm



HS-5037-2
140 mm

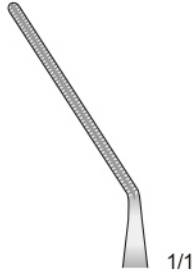

HS-5037-3
140 mm



HS-5037-4
130 mm

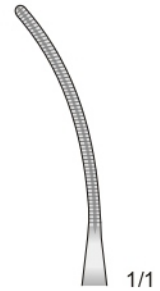

HS-5037-5
140 mm



HS-5037-6
130 mm



HS-5037-7
130 mm

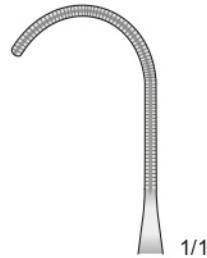

HS-5037-8
140 mm



HS-5037-9
135 mm

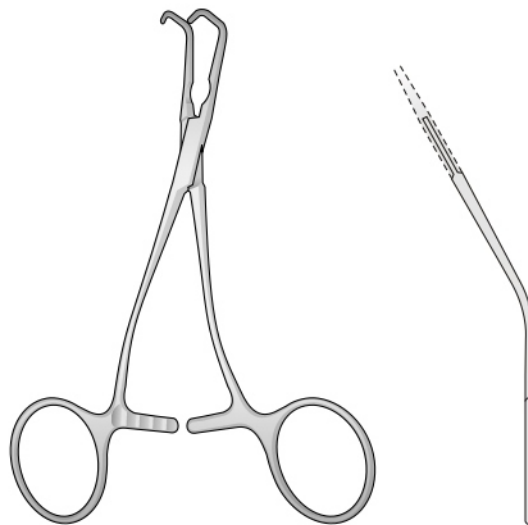

HS-5037
130 mm

Atraumatic Vessel Clamps

Atraumatische
 Atraumatic
 Atraumatische
 Atraumatiques
 Atraumaticas

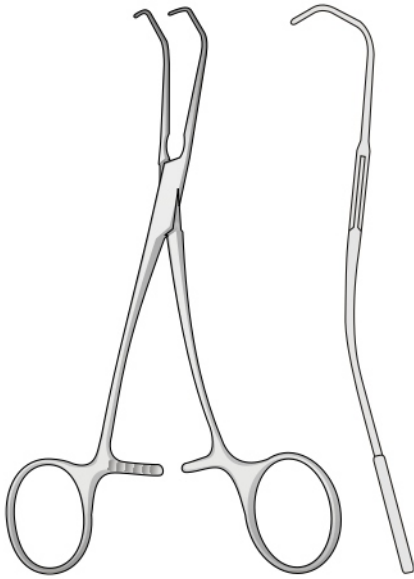

CASTANEDA
 HS-5039
 155 mm

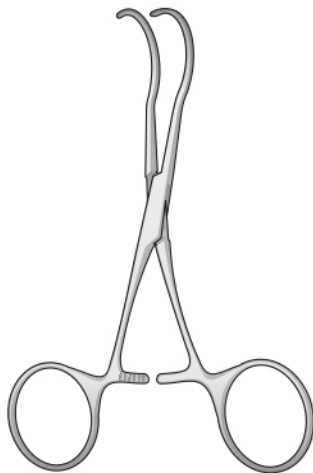
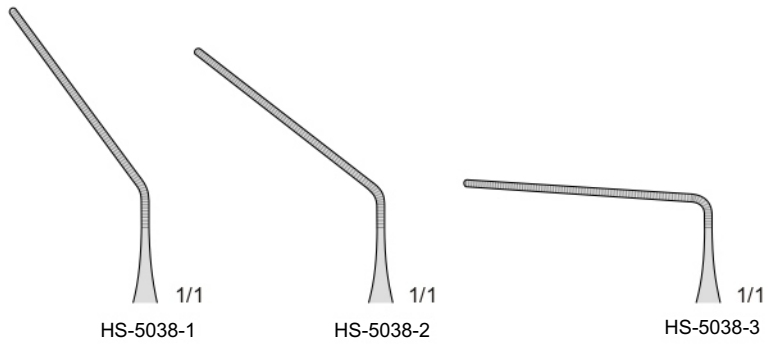
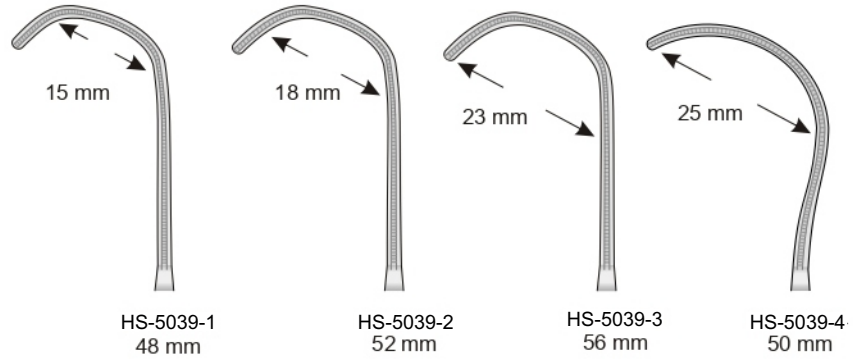

CASTANEDA
 HS-5038
 120 mm

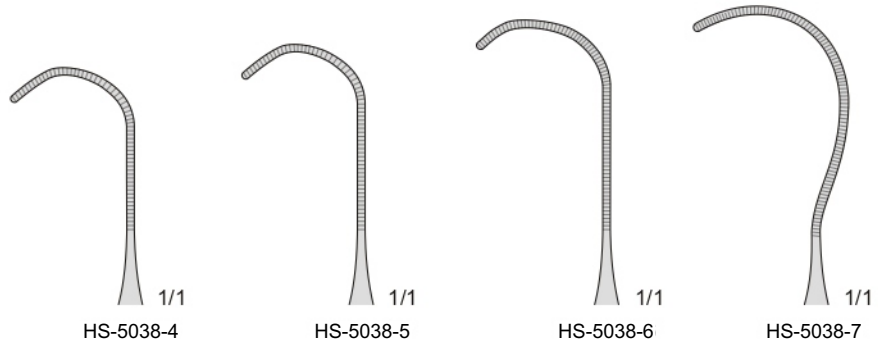



Atraumatic Vessel Clamps

Pinze per neonati e bambini
Atraumatic vessel clamps for babys and children
Sugling - und Kinderklemmen
Pinces-clamps pour nouveaux-nes et enfants
Pinzas vasculares atraumaticas para nios

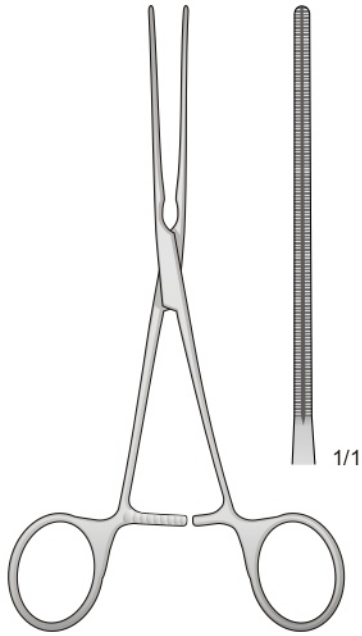

HS-5042
165 mm

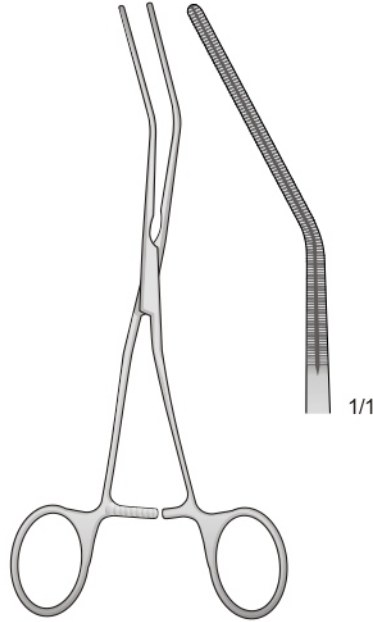

HS-5043
160 mm

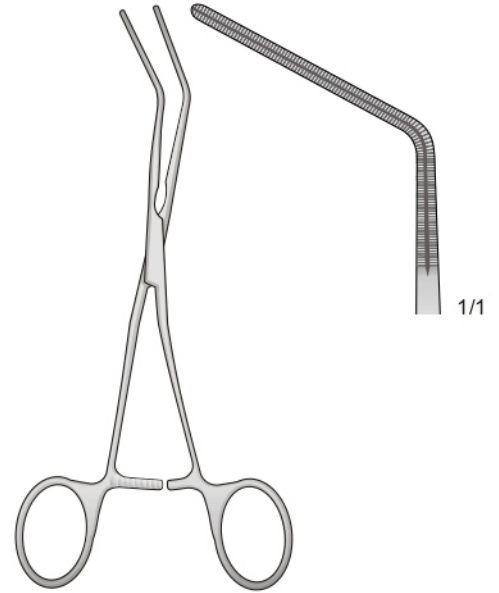

HS-5044
150 mm

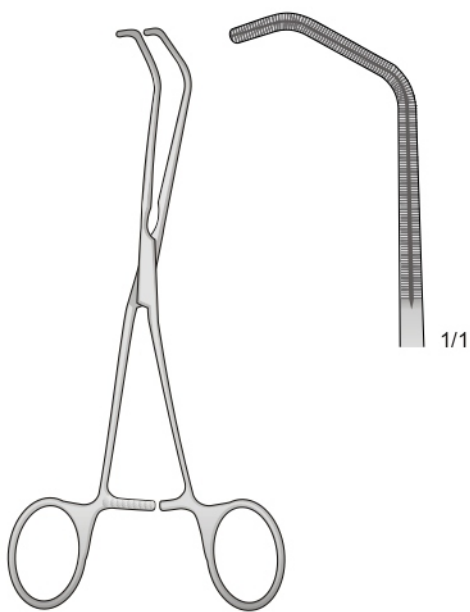

HS-5040
150 mm

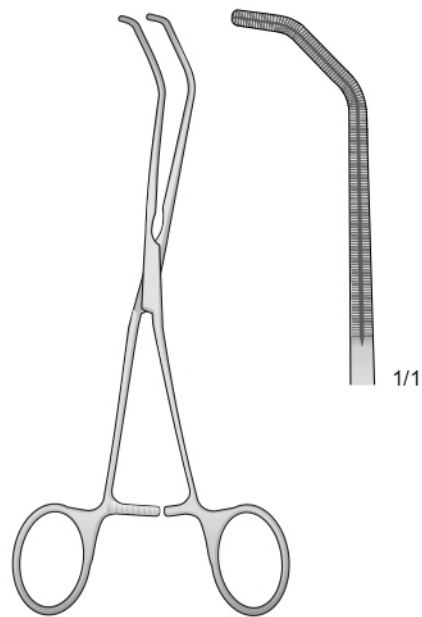

HS-5041
155 mm

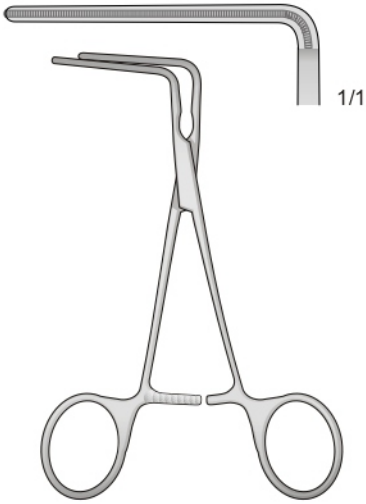

De BAKEY
HS-5047
100 mm

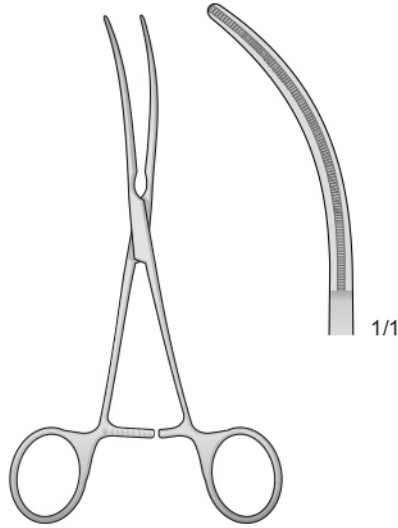

De BAKEY
HS-5048
110 mm

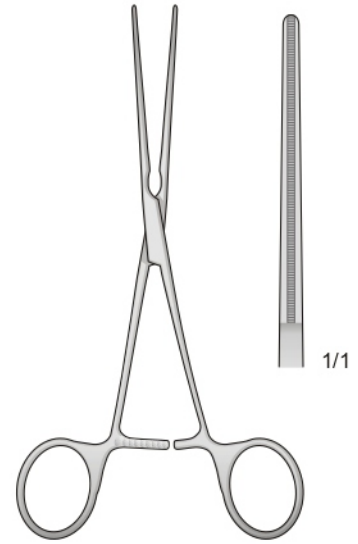

De BAKEY
HS-5049
120 mm

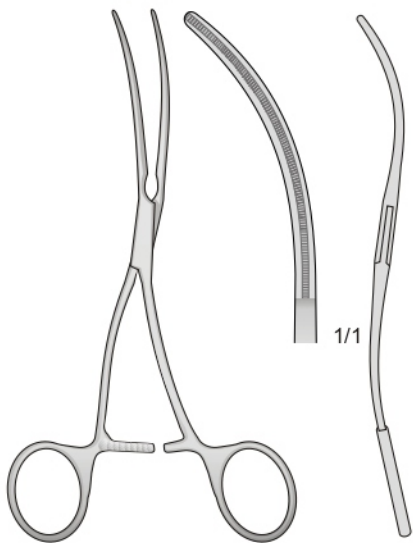

De BAKEY
HS-5045
120 mm

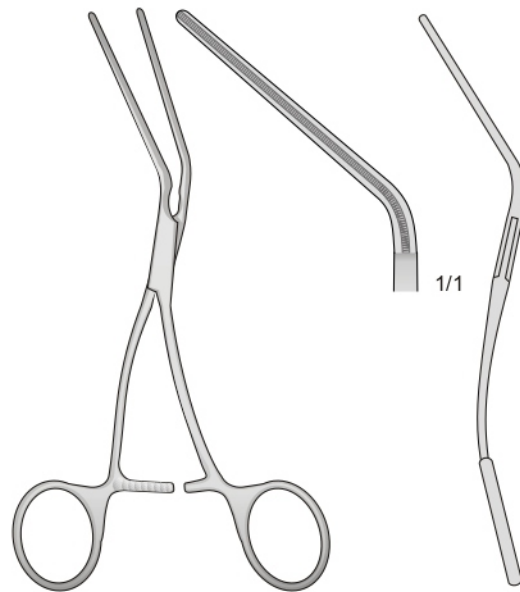

De BAKEY
HS-5046
130 mm

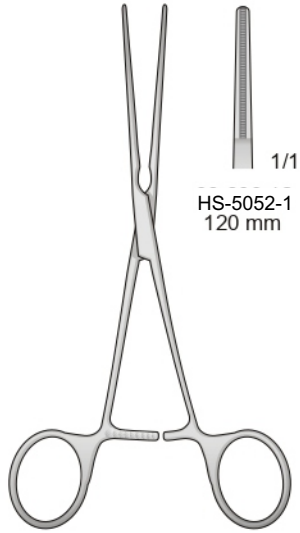

De BAKEY - MOSQUITO
HS-5052
120 mm

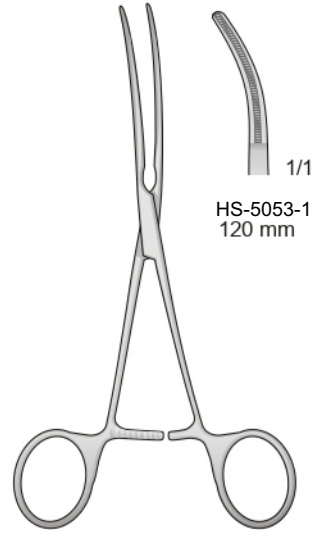

De BAKEY - MOSQUITO
HS-5053
120 mm

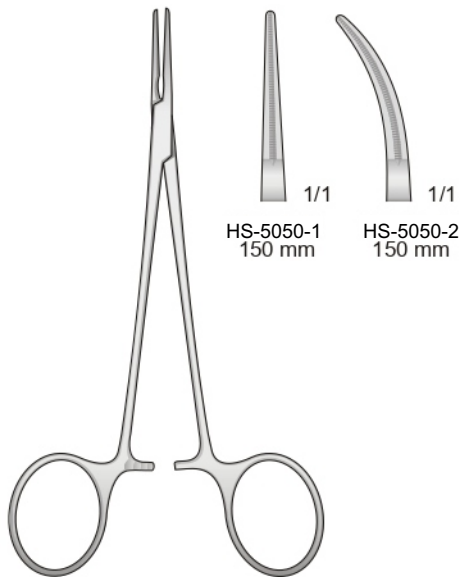

De BAKEY - MOSQUITO
HS-5050
150 mm

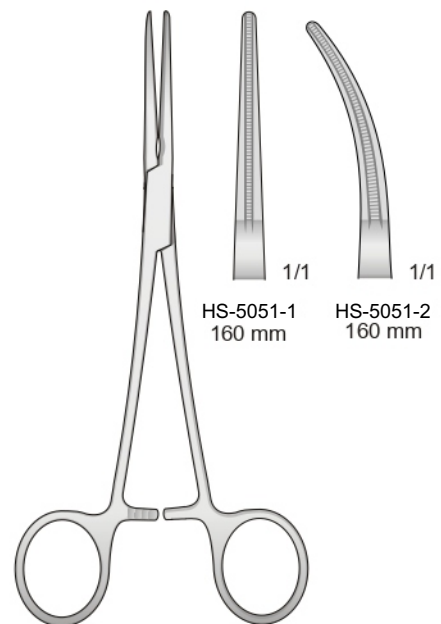

De BAKEY - RANKIN
HS-5051
160 mm

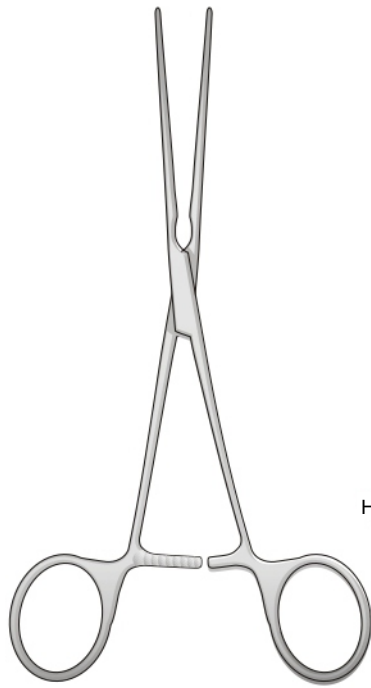

De BAKEY - PEAN
HS-5055

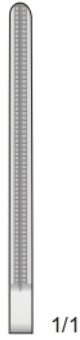

HS-5055-1
140 mm

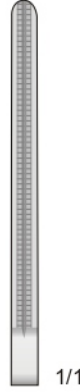

HS-5055-2
160 mm

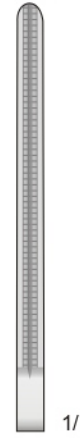

HS-5055-3
180 mm

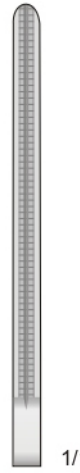

HS-5055-4
200 mm

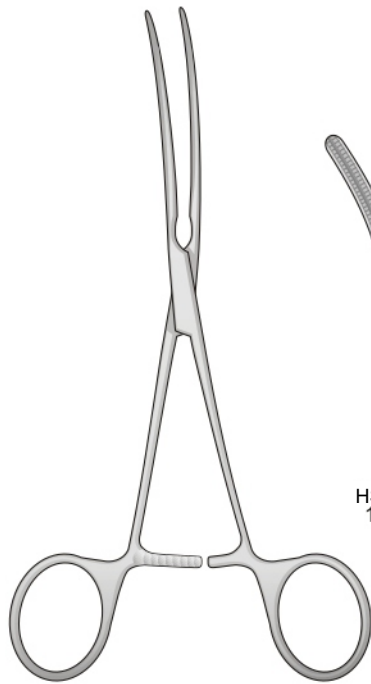

De BAKEY - PEAN
HS-5054



HS-5054-1
140 mm

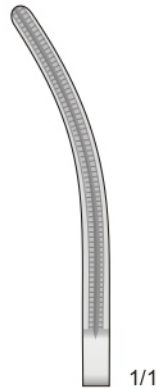

HS-5054-2
160 mm

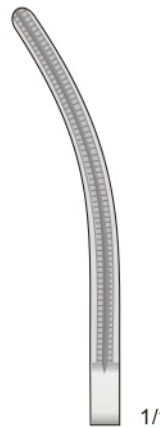

HS-5054-3
180 mm

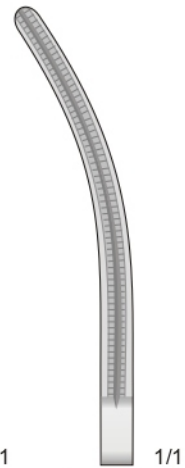

HS-5054-4
200 mm

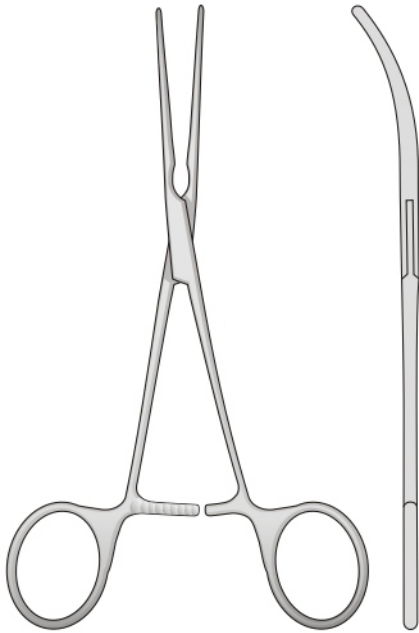

De BAKEY
HS-5060
165 mm

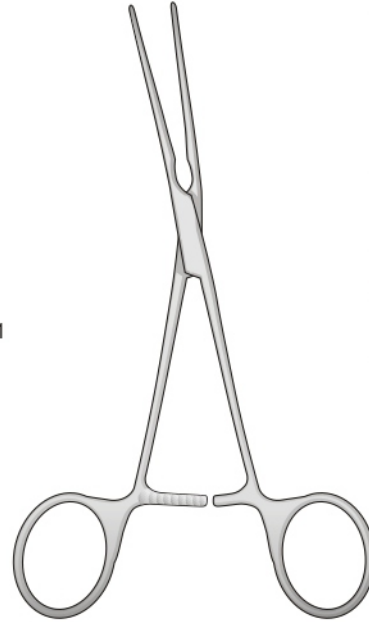
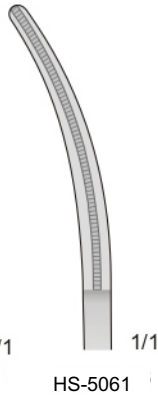
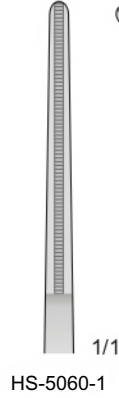

De BAKEY
HS-5062
165 mm

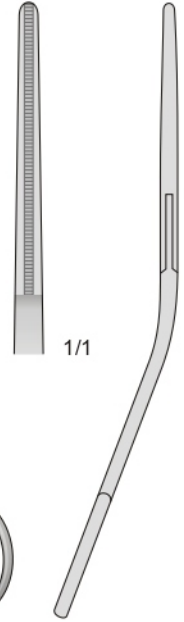

1/1

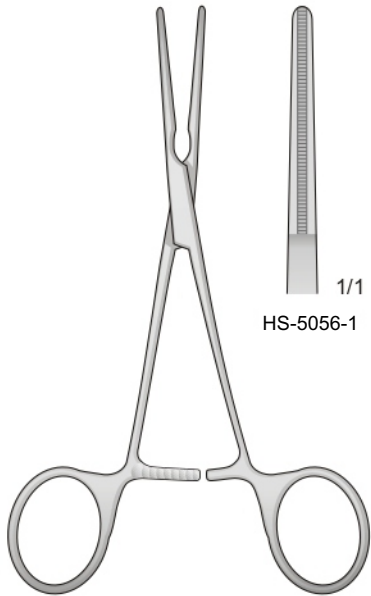

De BAKEY - BAINBRIDGE
HS-5056
155 mm

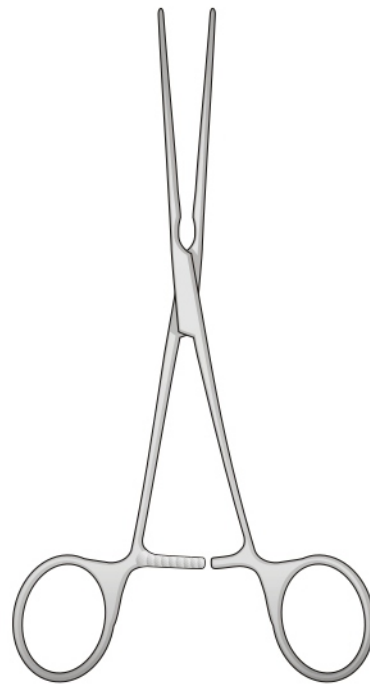
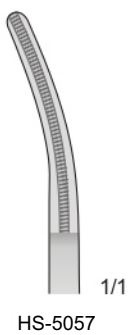
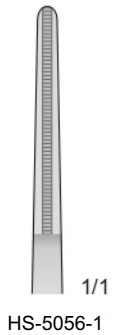

De BAKEY - BAINBRIDGE
HS-5058
180 mm

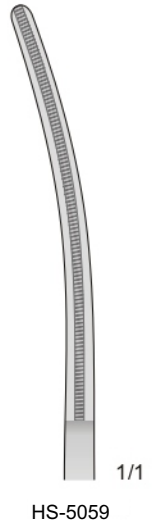
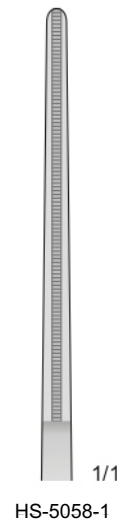

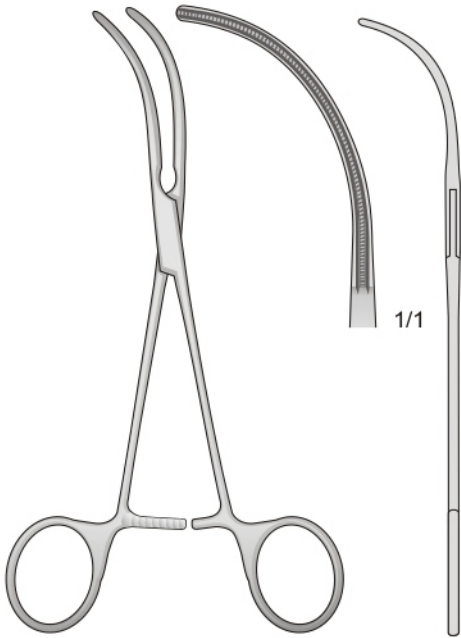

De BAKEY
HS-5064
160 mm

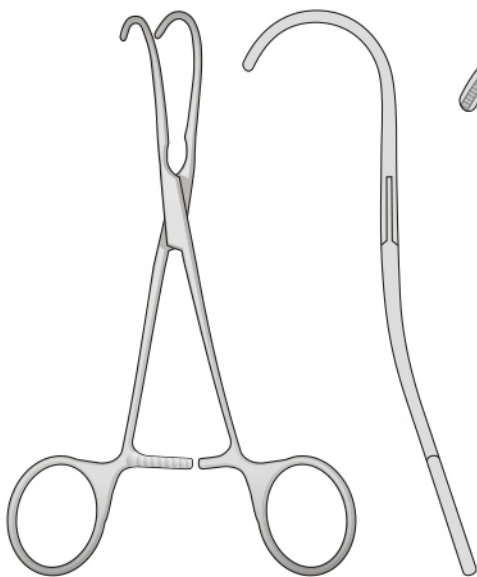

De BAKEY
HS-5063
150 mm

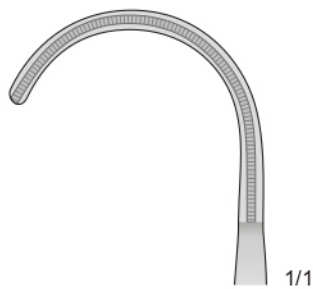

HS-5063-1

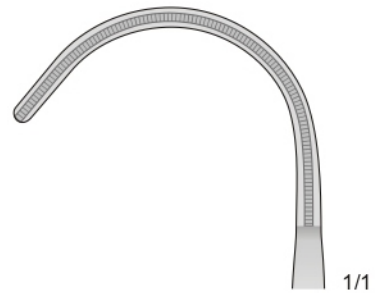

HS-5063-2

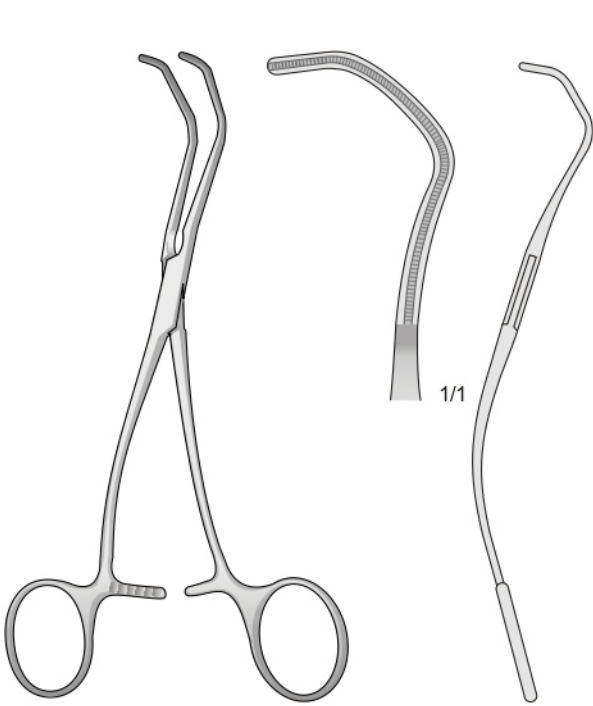

De-BAKEY
 HS-5066
 170 mm

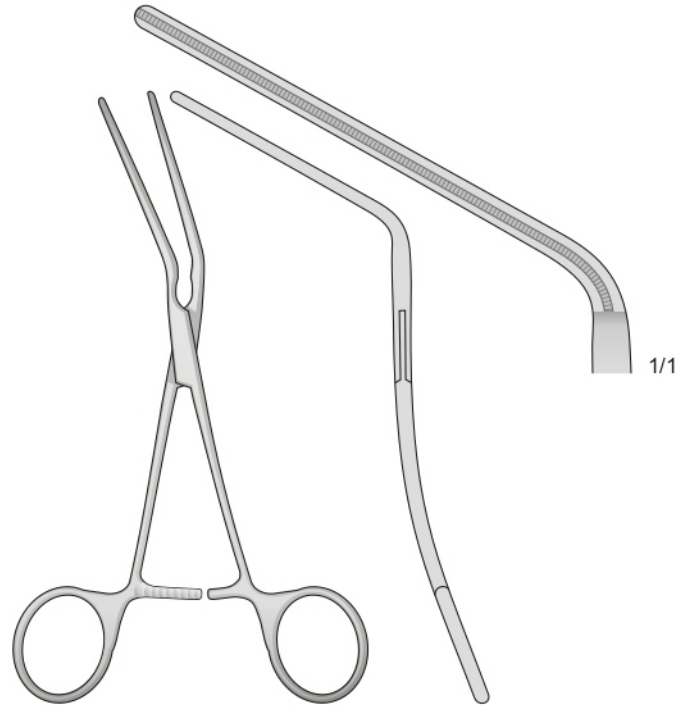

De BAKEY
 HS-5067
 165 mm

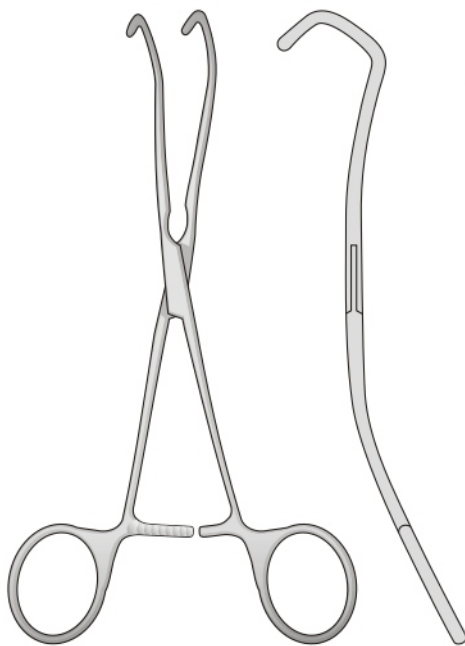

DERRA
 HS-5065
 170 mm

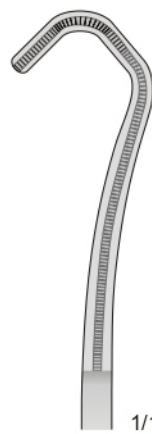

HS-5065-1

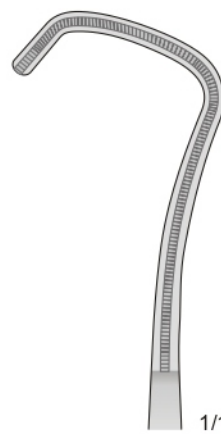

HS-5065-2

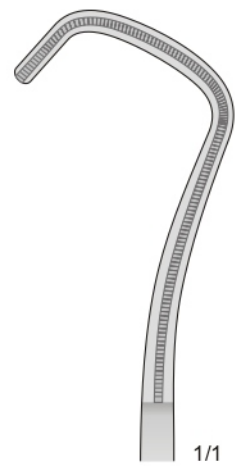

HS-5065-3

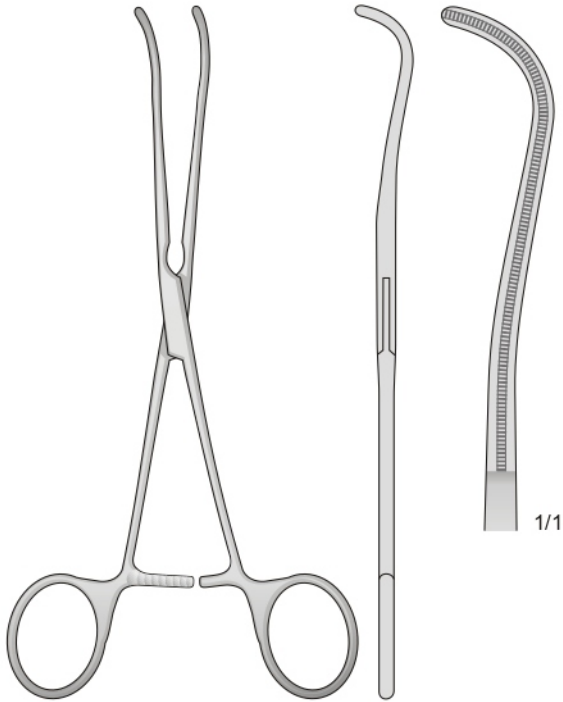

De BAKEY
 HS-5070
 190 mm

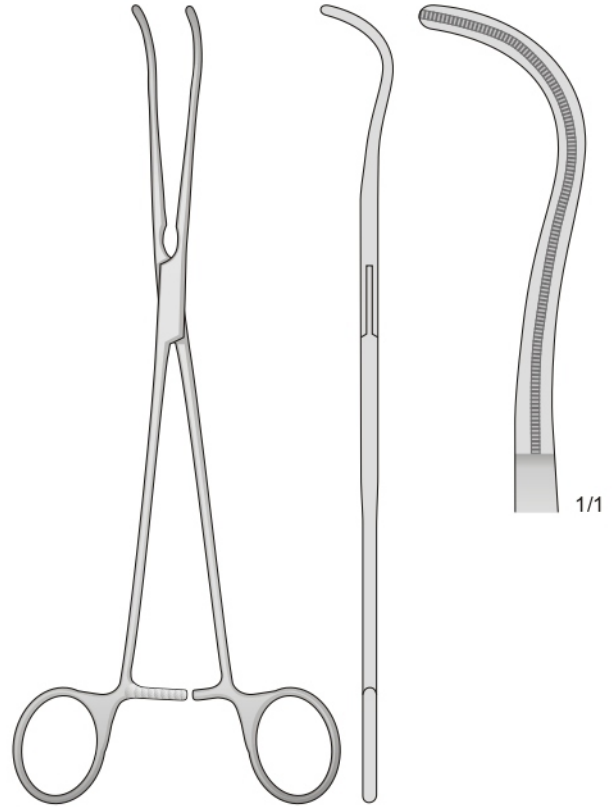

De BAKEY
 HS-5071
 230 mm

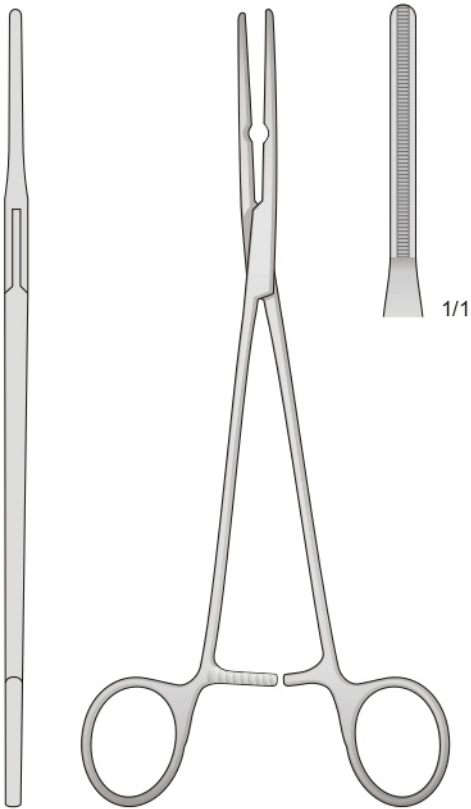

De BAKEY
 HS-5068
 215 mm

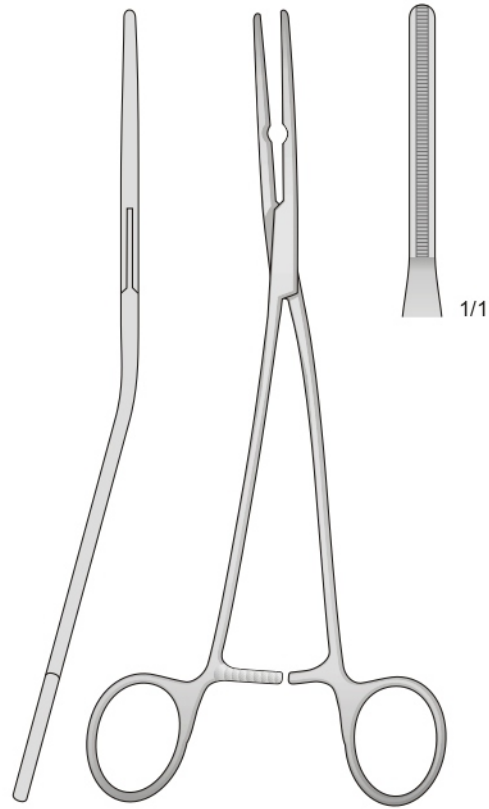

De BAKEY
 HS-5069
 215 mm

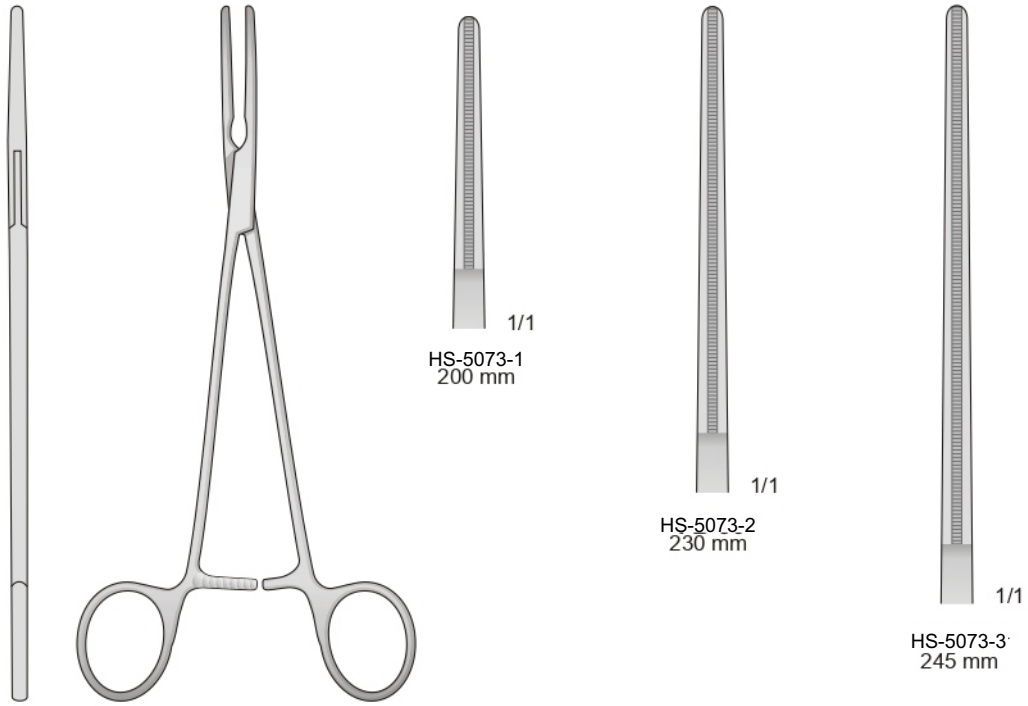

De BAKEY
 HS-5073

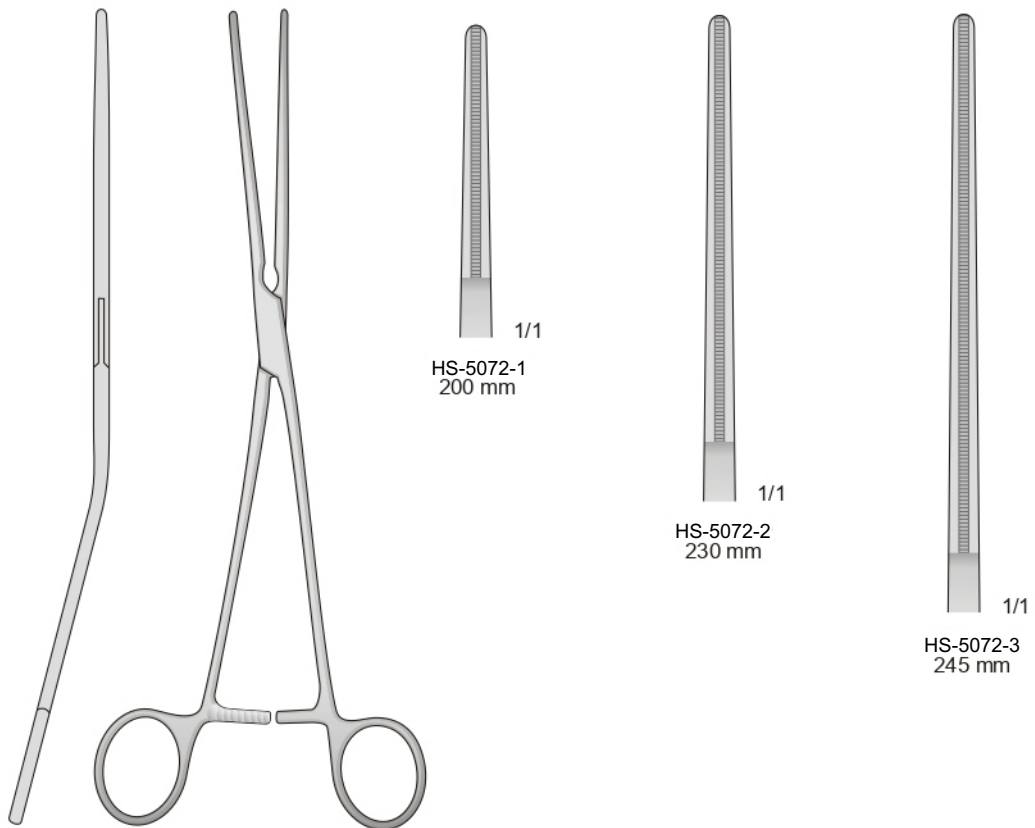

De BAKEY
 HS-5072

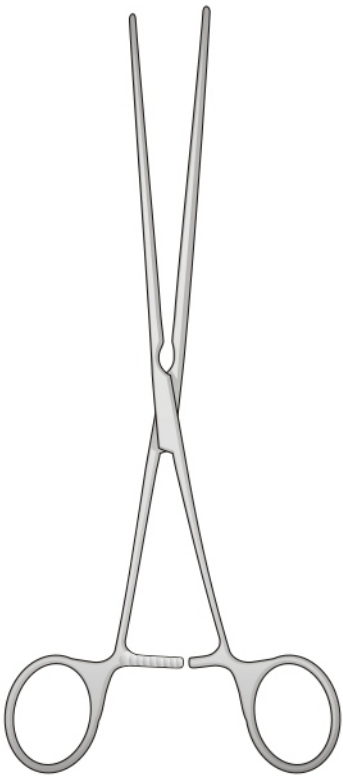

De BAKEY
 HS-5076
 220 mm

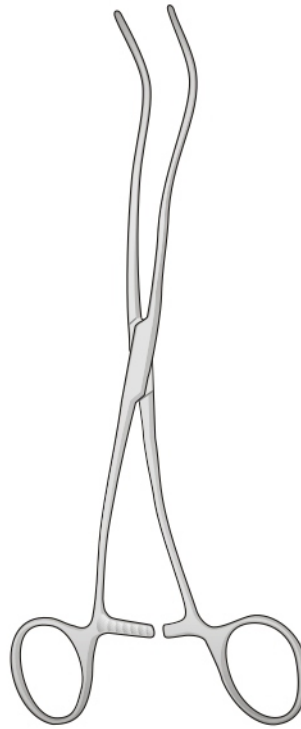
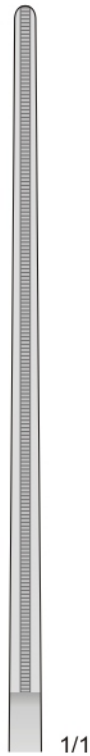

De BAKEY
 HS-5077
 200 mm

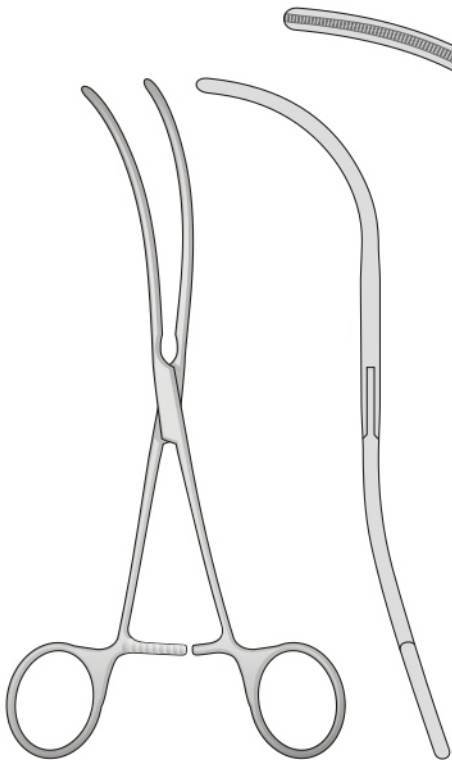
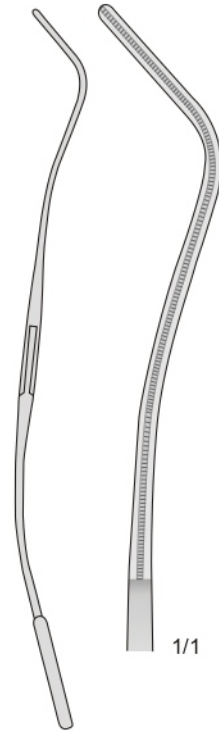

De BAKEY
 HS-5074
 180 mm

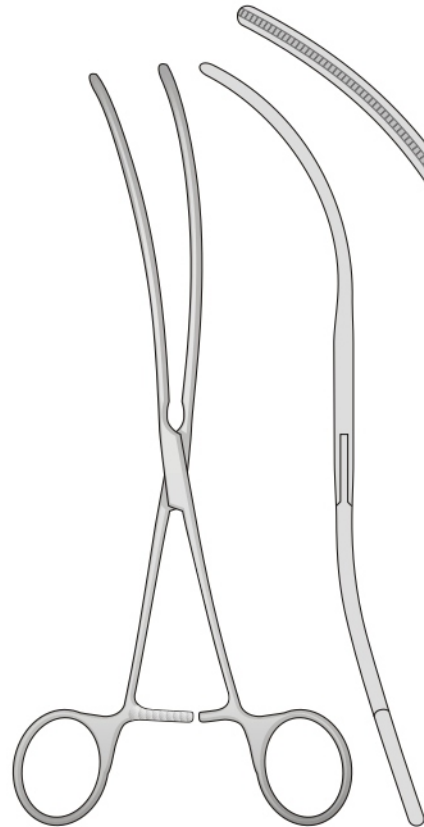

De BAKEY
 HS-5075
 200 mm

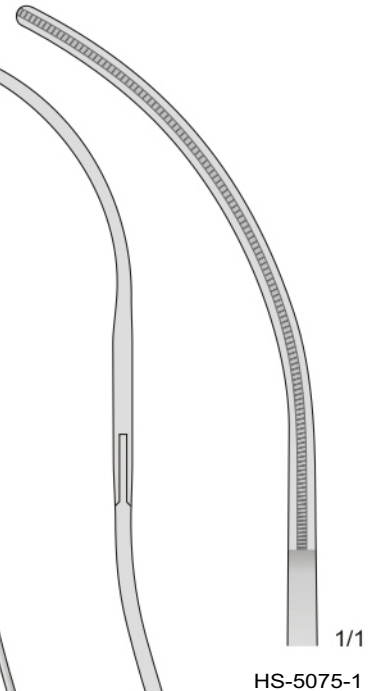

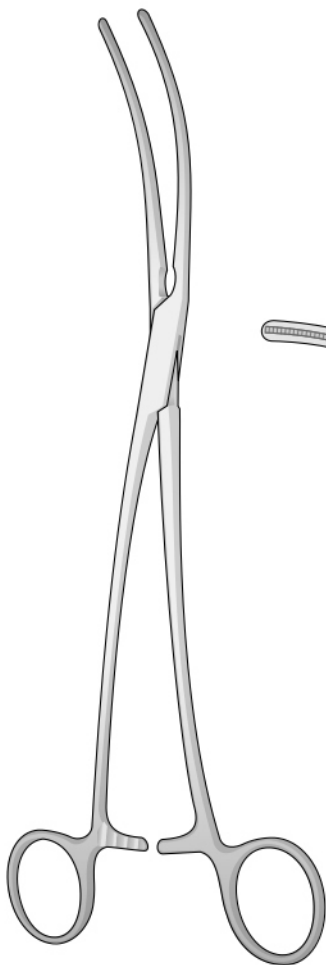

De BAKEY-BAHNSON
HS-5078

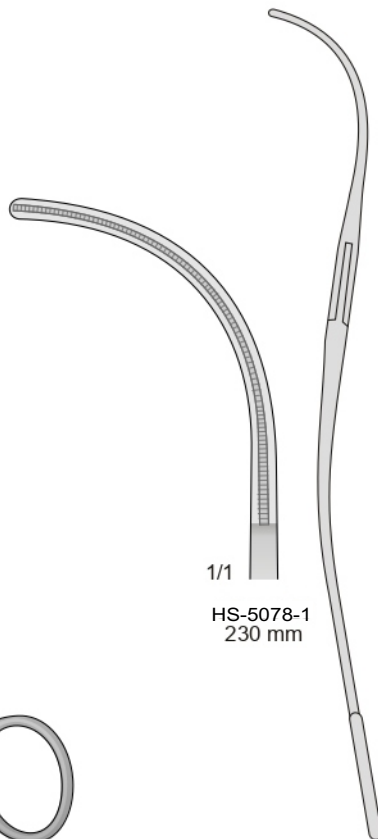

1/1
HS-5078-1
230 mm

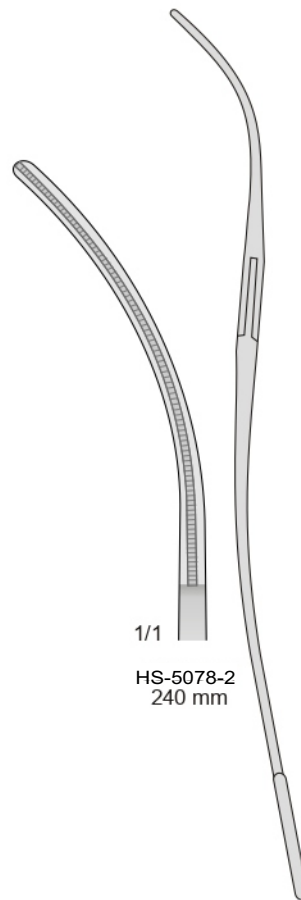

1/1
HS-5078-2
240 mm

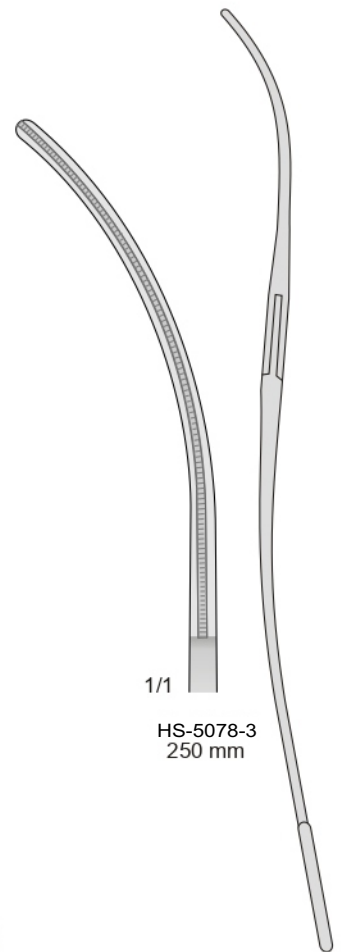

1/1
HS-5078-3
250 mm



HS-5079-1
250 mm

HS-5079-2
270 mm

HS-5079-3
280 mm

HS-5079-4
330 mm

De BAKEY
HS-5079

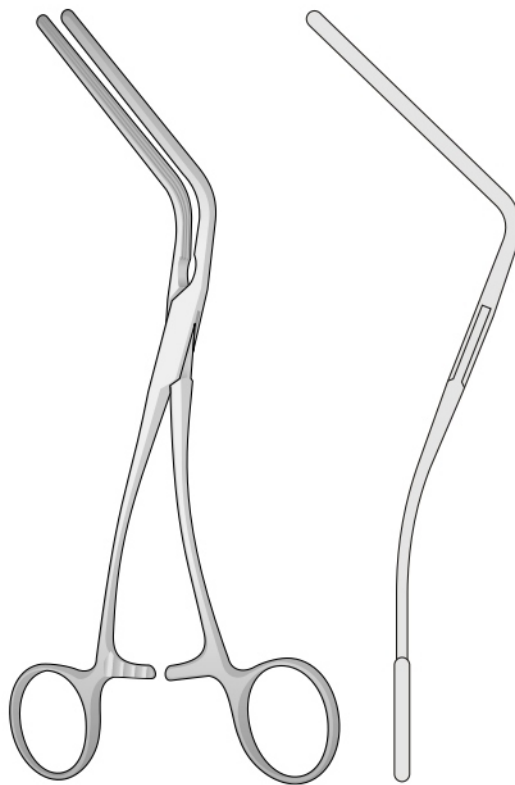
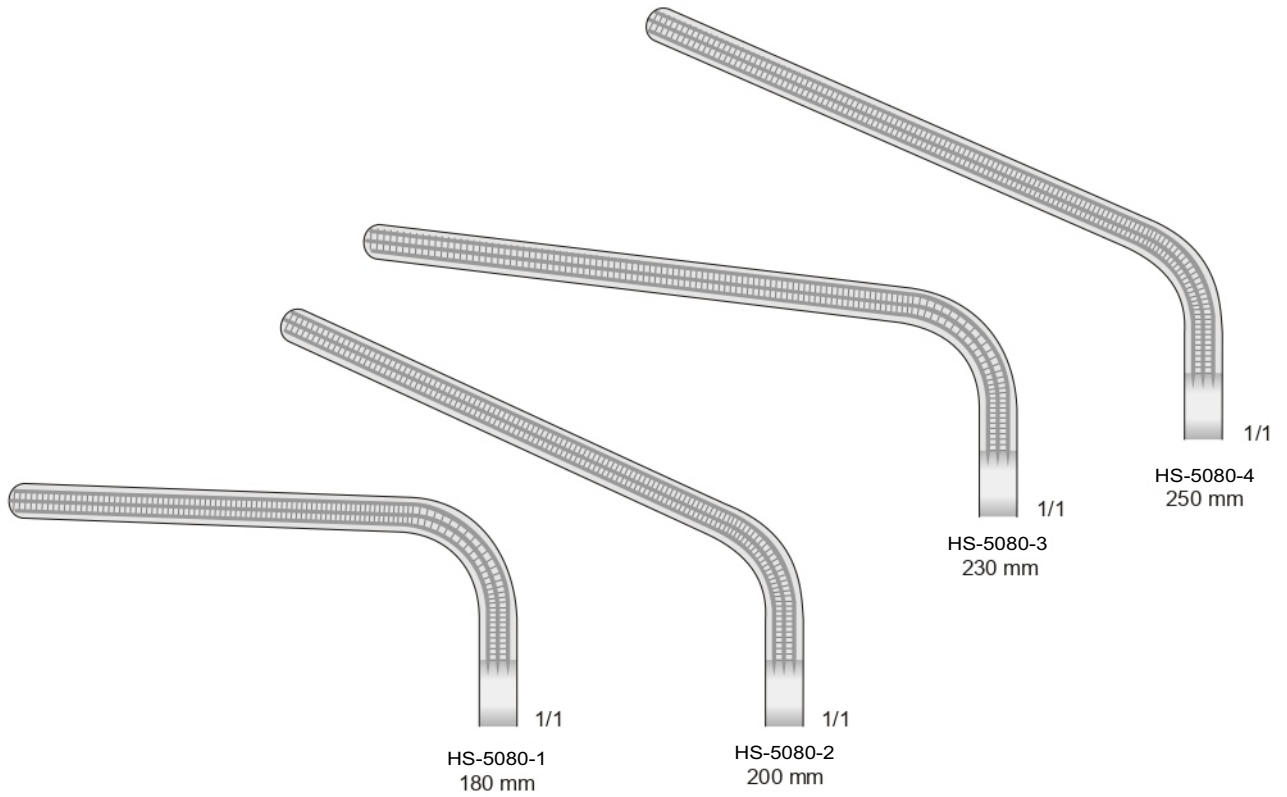

MORRIS-De BAKEY
HS-5080

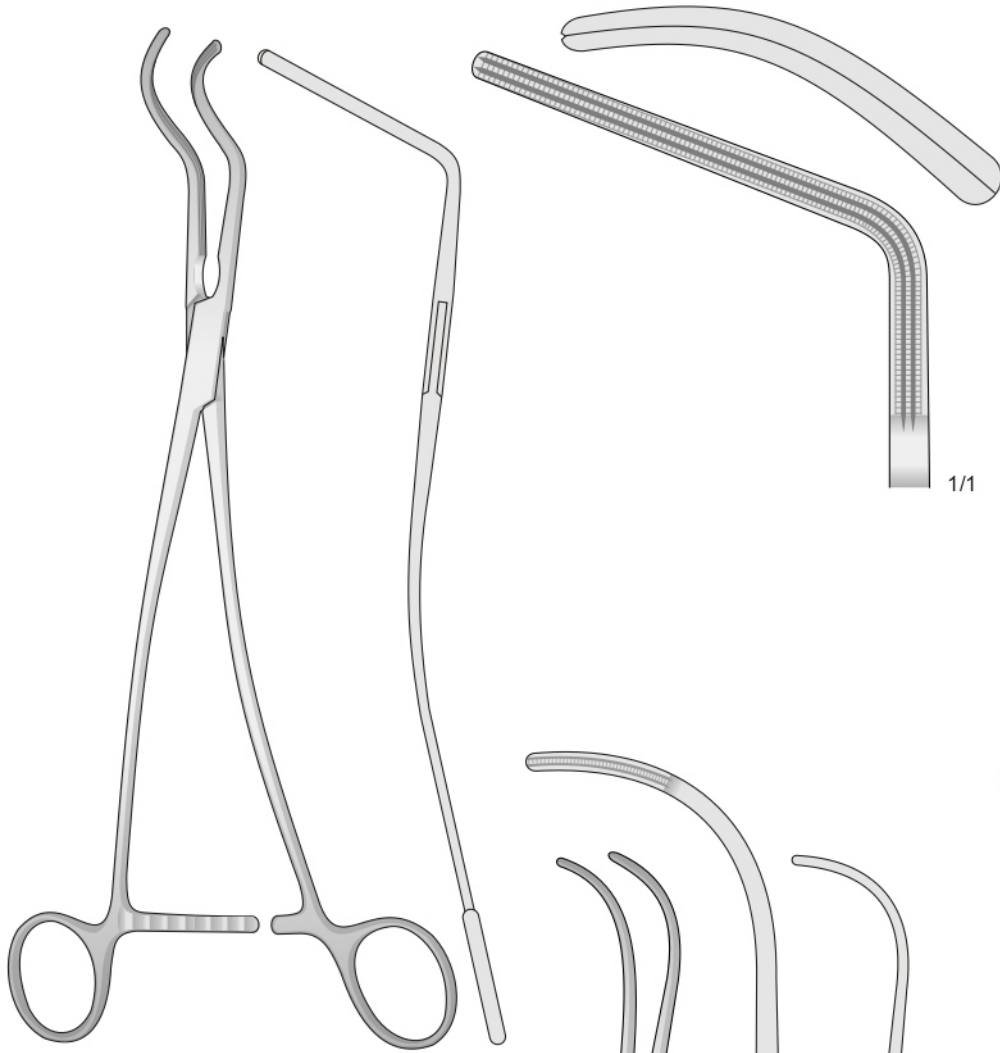

De BAKEY
HS-5081
270 mm

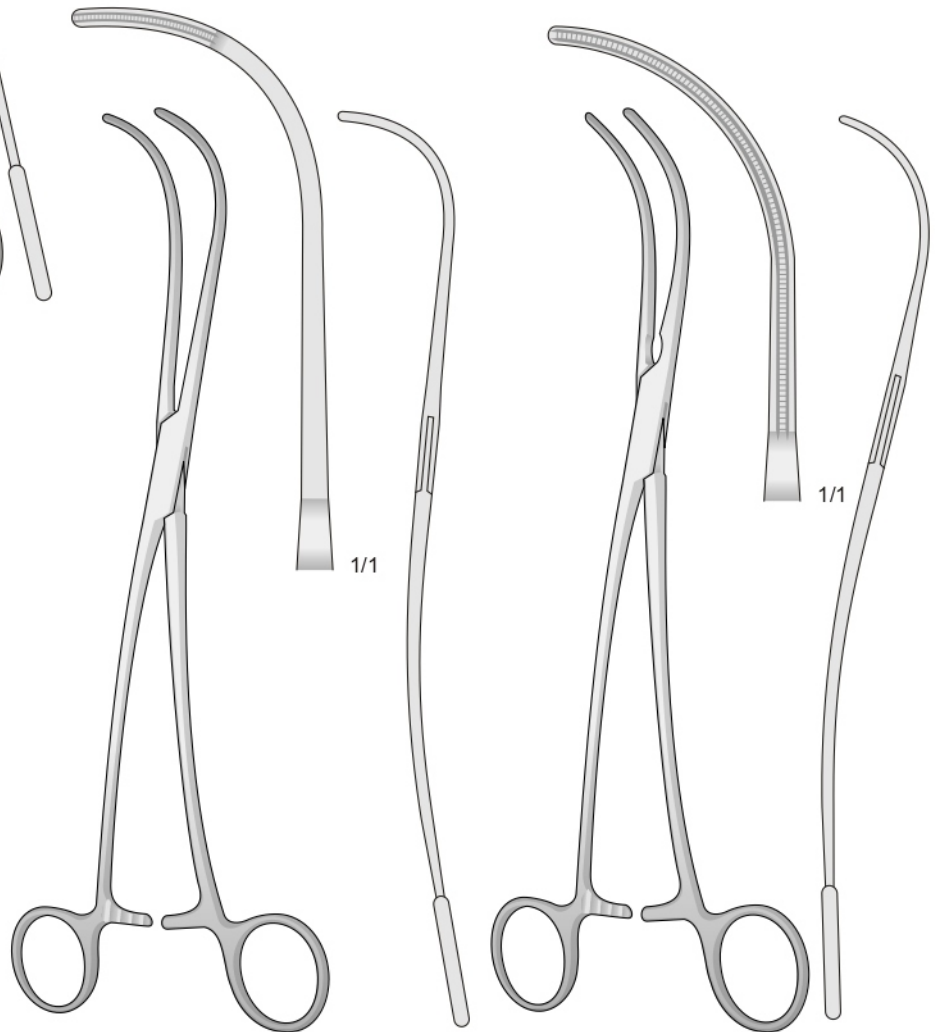

De BAKEY
HS-5082
240 mm

De BAKEY
HS-5083
240 mm



De BAKEY
HS-5084

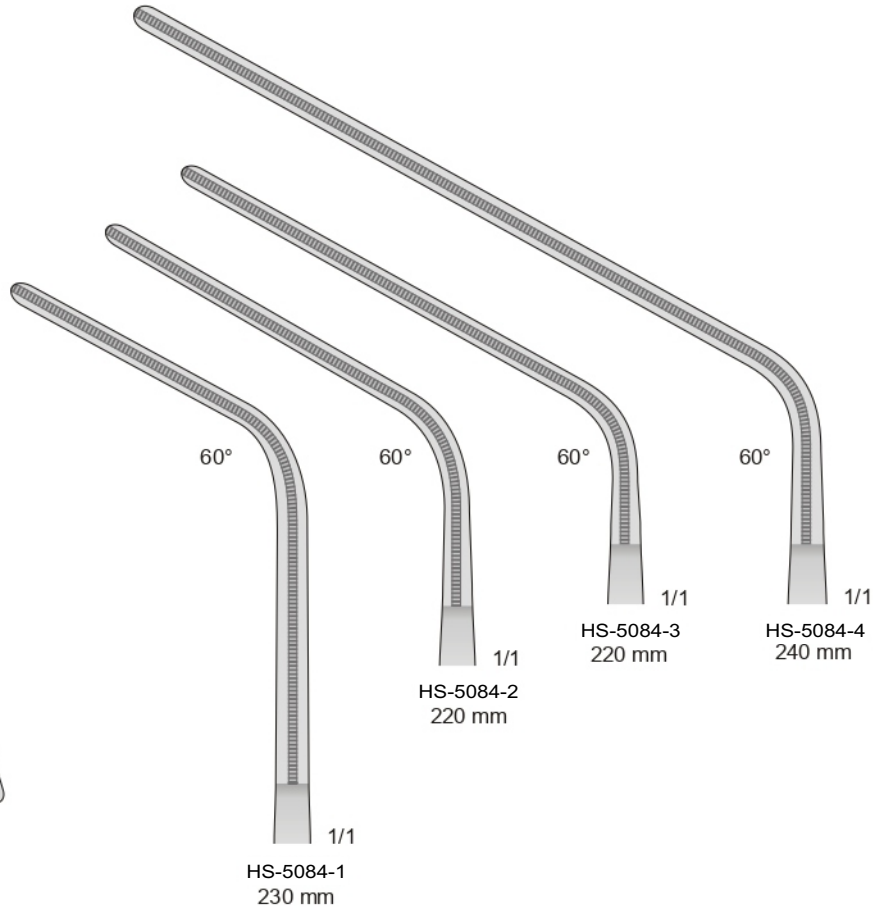

De-BAKEY
HS-5085

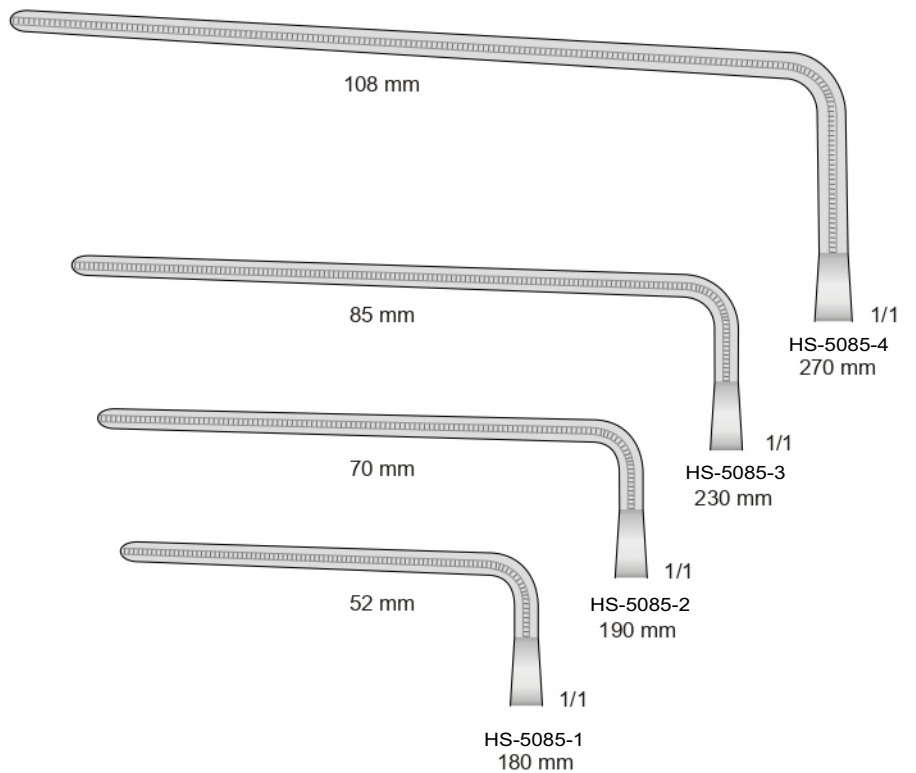



De BAKEY-SATINSKY
HS-5086

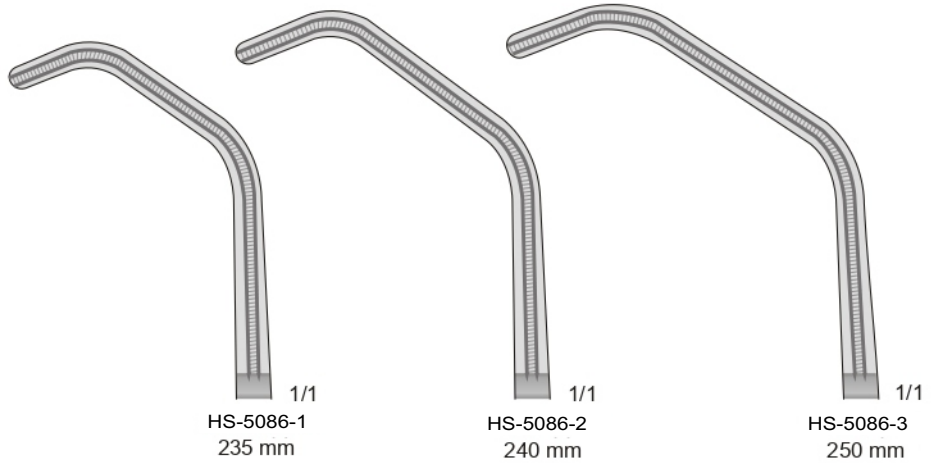

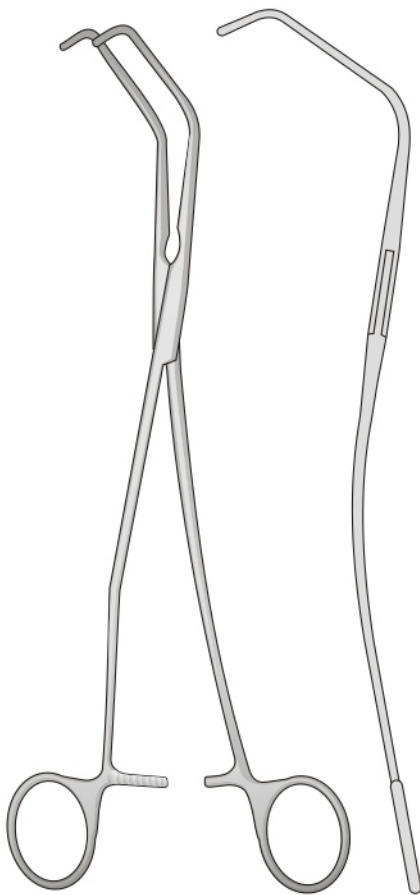
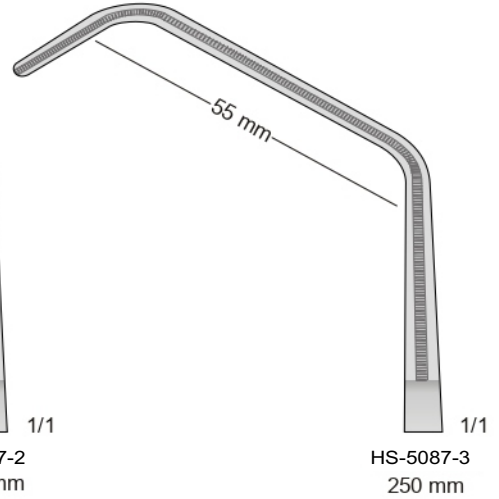
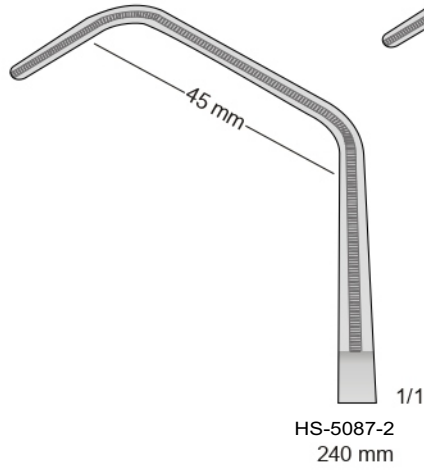
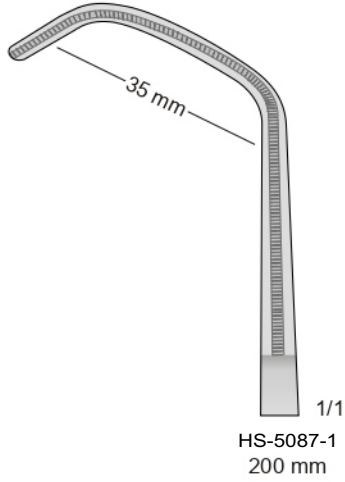

De-BAKEY
HS-5087

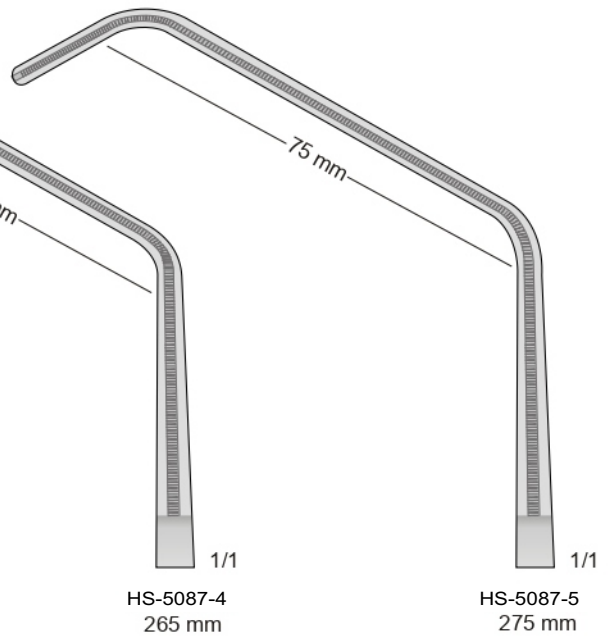
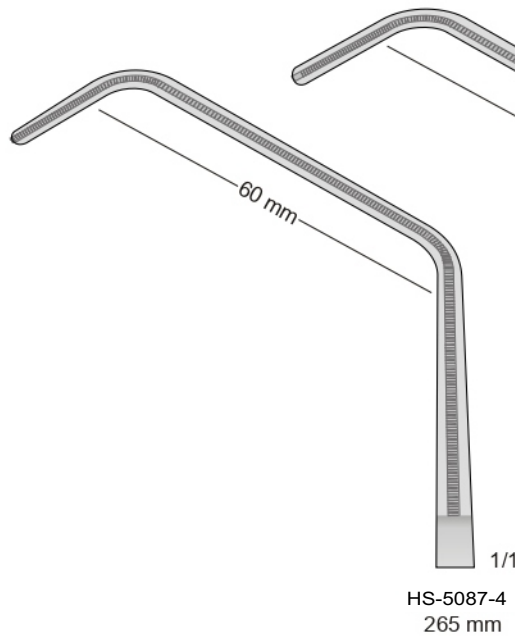

Atraumatic Vessel Clamps



1/1
 HS-5088-2
 240 mm

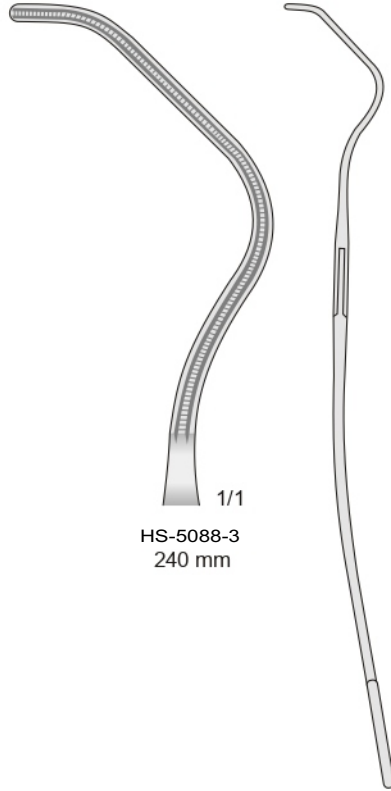

1/1
 HS-5088-3
 240 mm

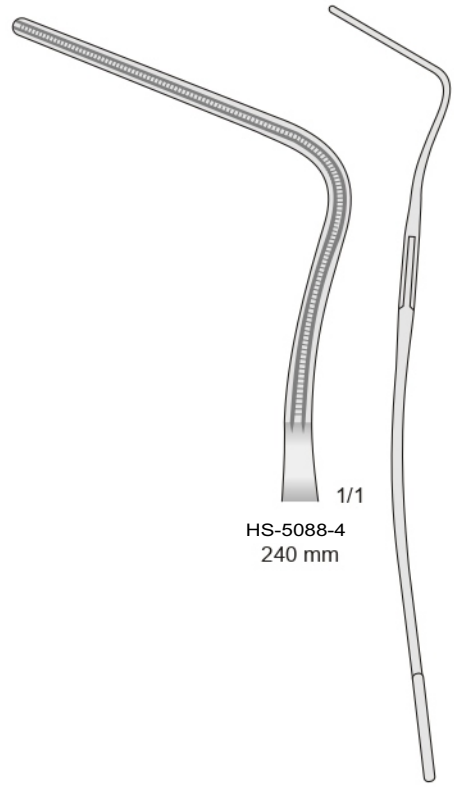

1/1
 HS-5088-4
 240 mm

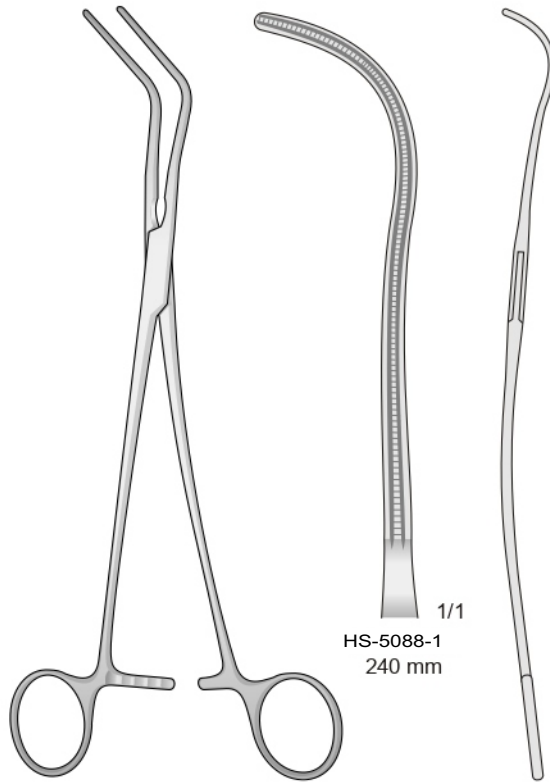

1/1
 HS-5088-1
 240 mm

De BAKEY-HARKEN
 HS-5088

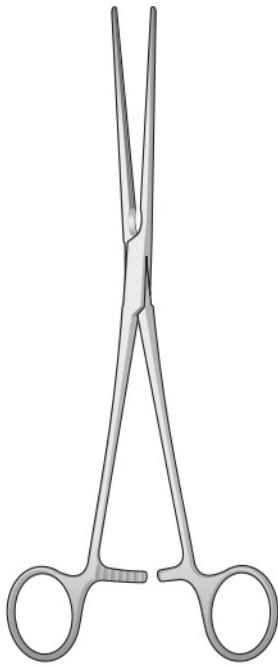

De BAKEY
HS-5088



HS-5088-1
215 mm



HS-5088-2
230 mm



HS-5088-3
270 mm



HS-5088-4
315 mm

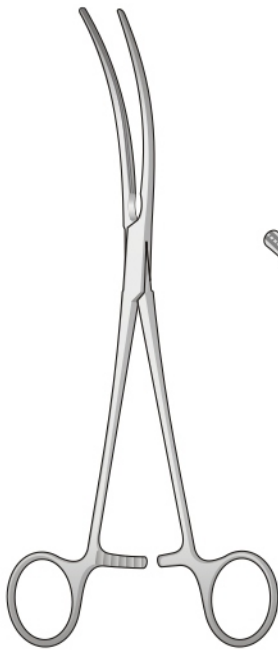

De BAKEY
HS-5089

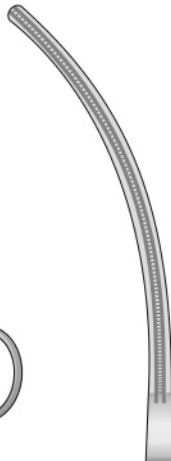

HS-5089-1
215 mm



HS-5089-2
230 mm

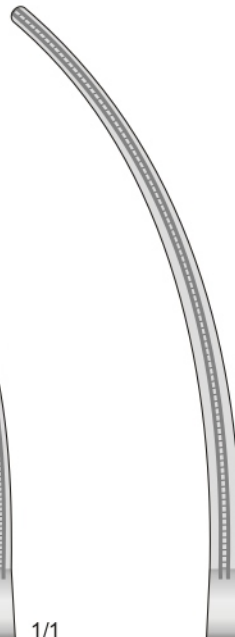

HS-5089-3
270 mm

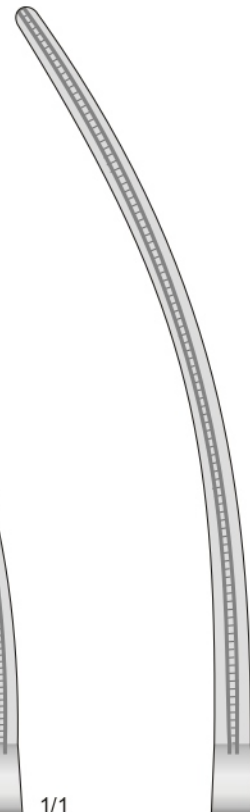

HS-5089-4
310 mm

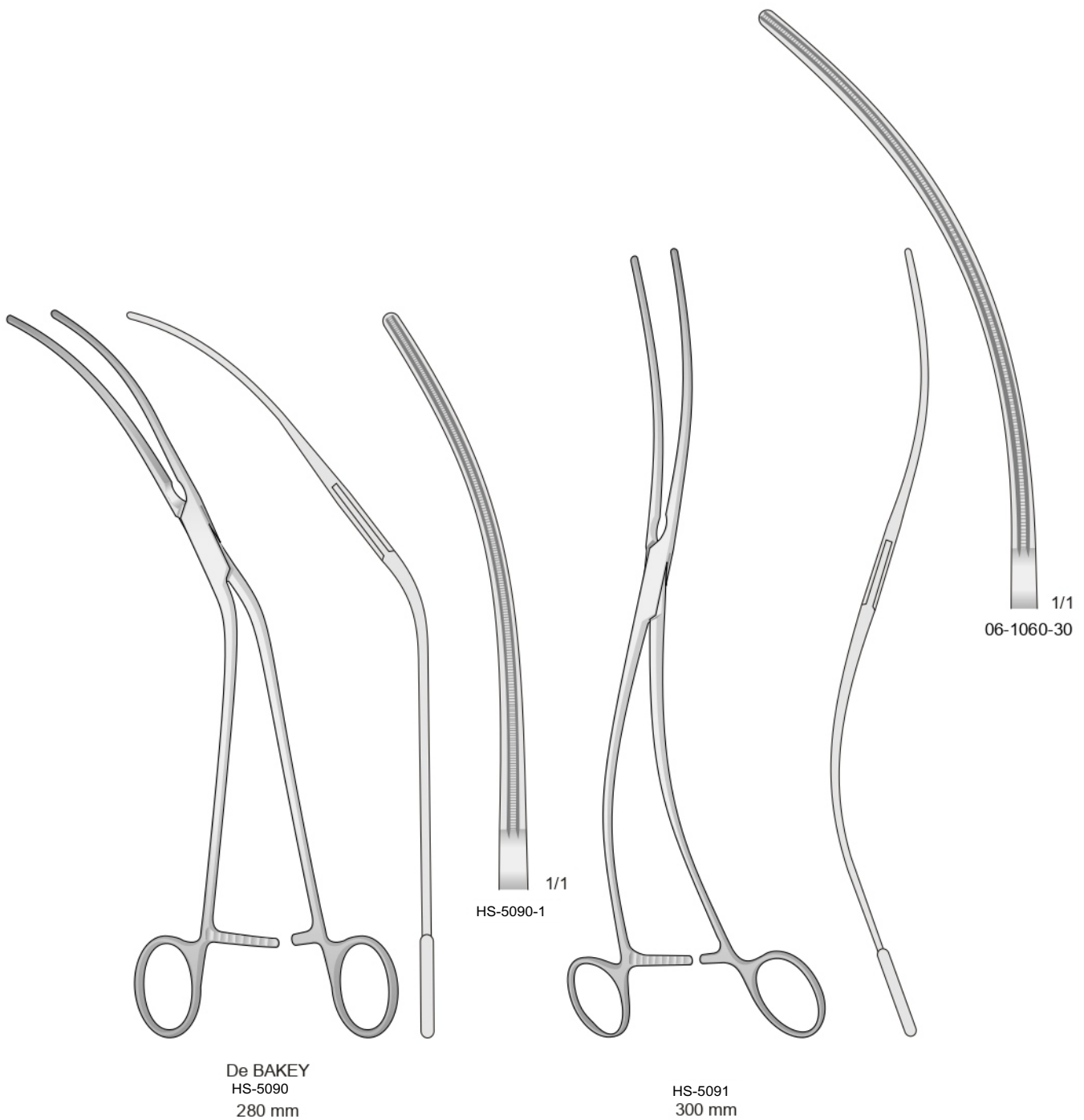

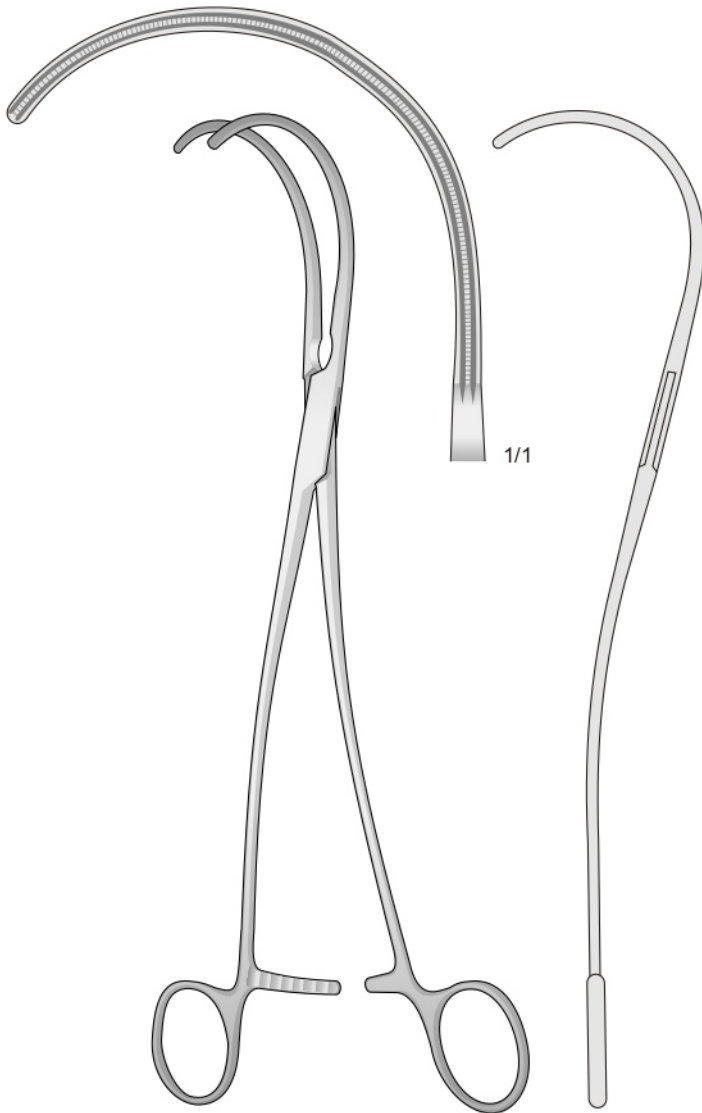

De BAKEY
HS-5092
260 mm

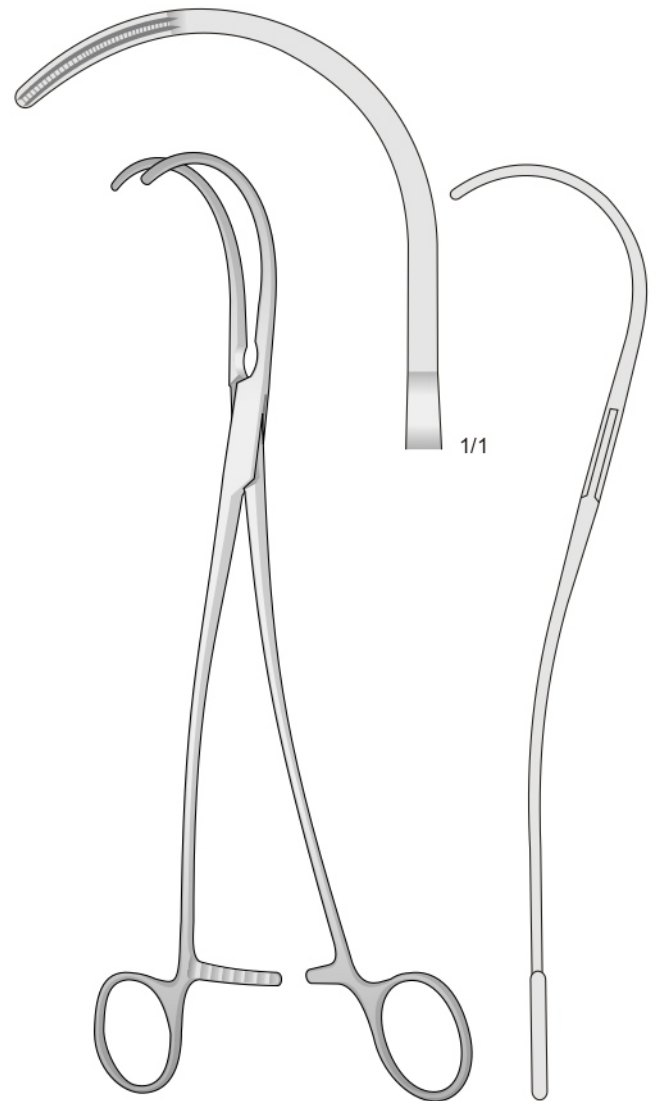

De BAKEY
HS-5093
250 mm

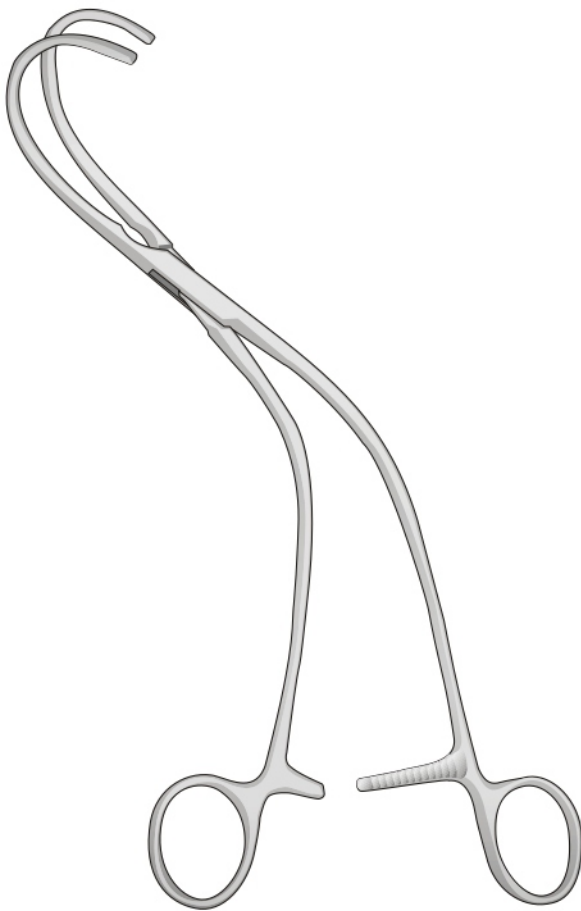
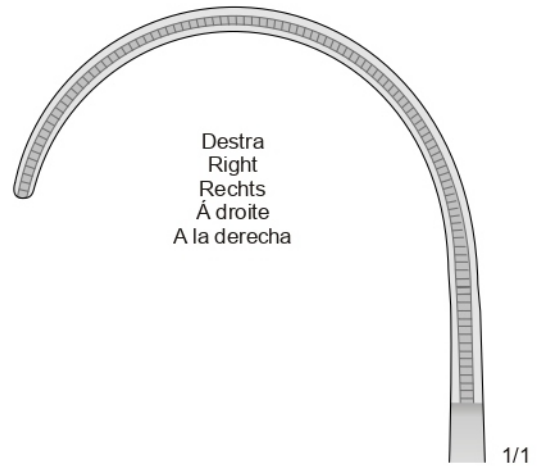
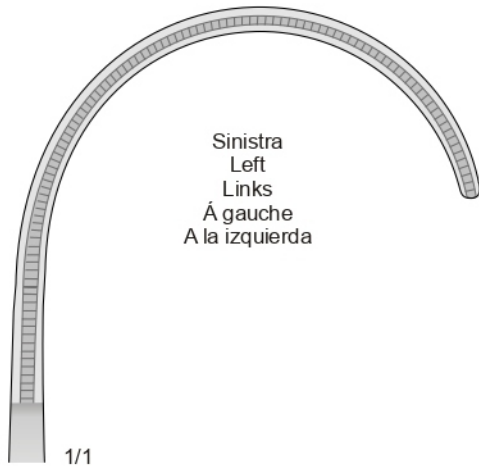

WEBER
HS-5094
260 mm

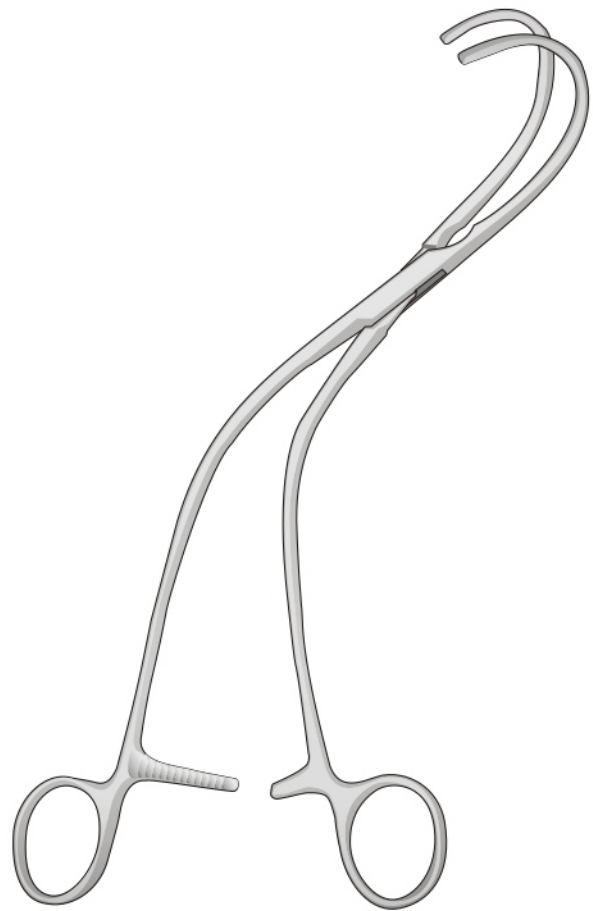

WEBER
HS-5095
260 mm

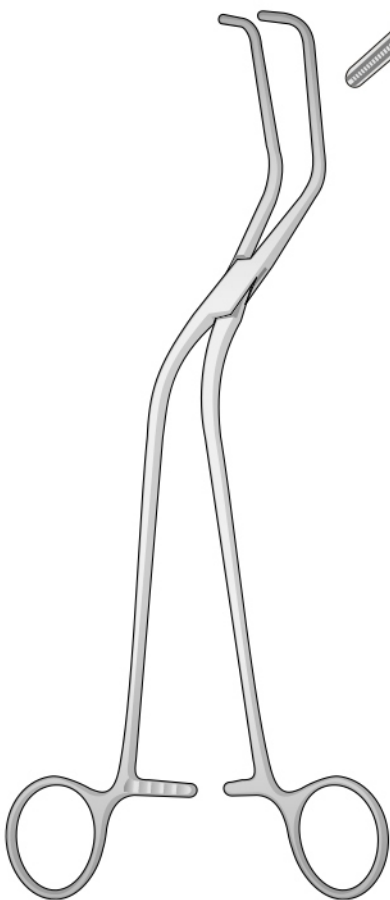

OCHSNER
HS-5096
235 mm



1/1

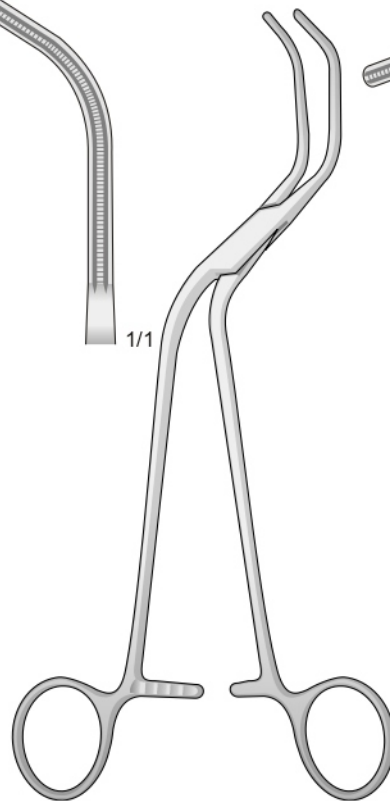

DIETRICH
HS-5097
210 mm

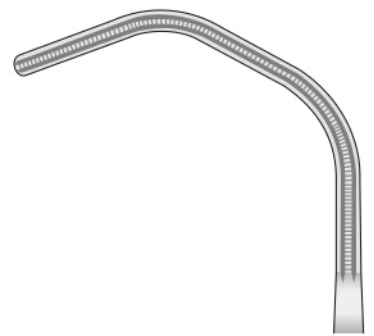

1/1

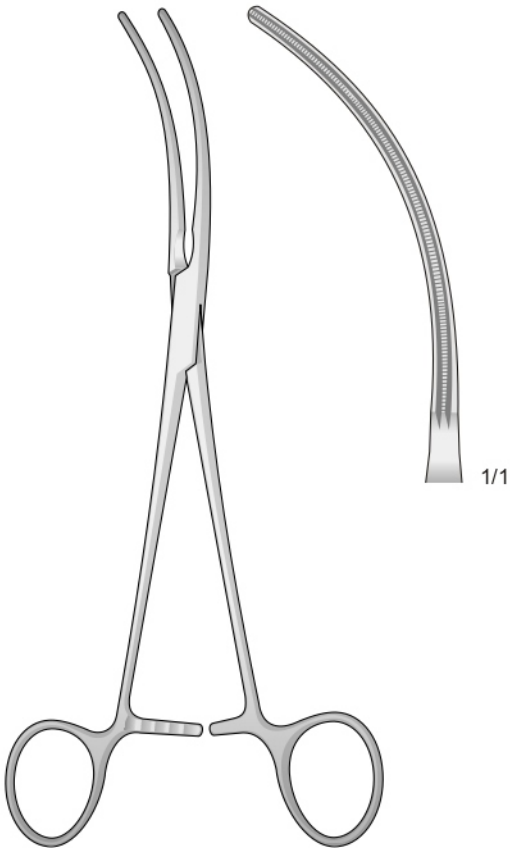

POTTS
HS-5097
220 mm

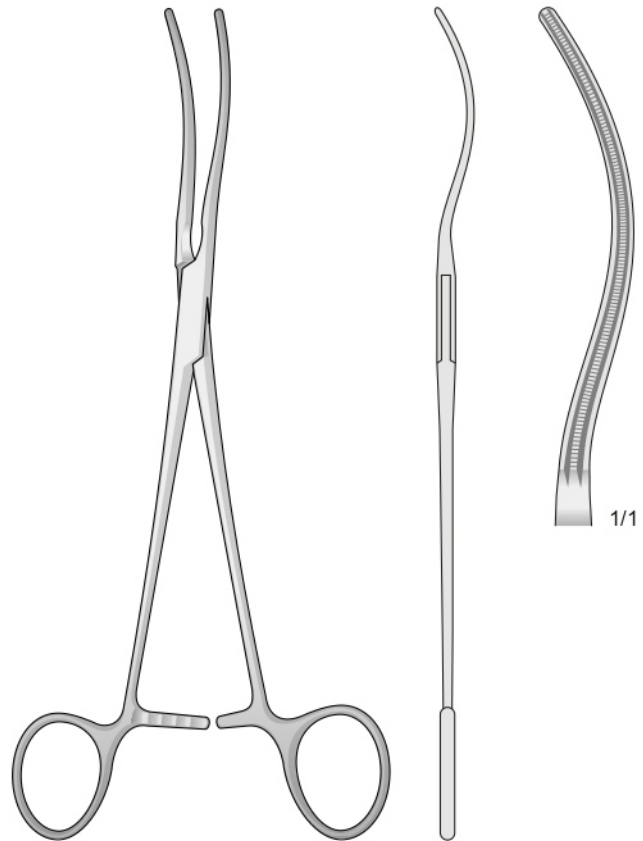

POTTS
HS-5098
220 mm

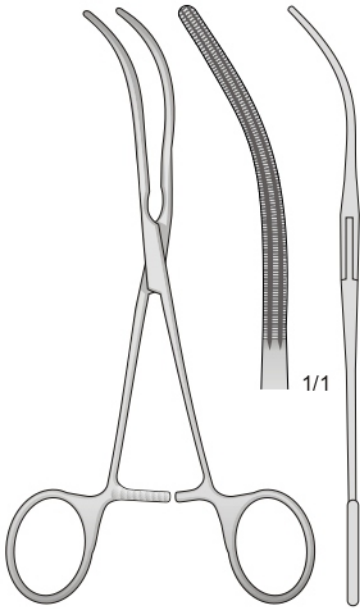

GLOVER
06-1140-17
170 mm

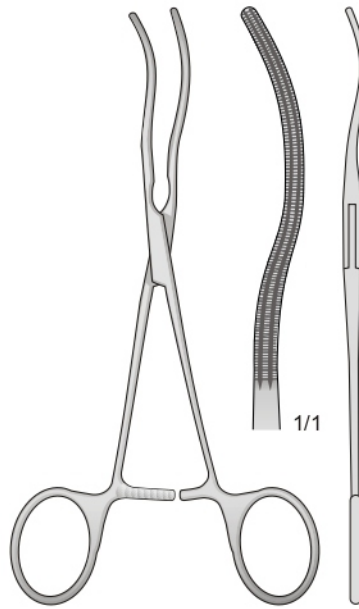

06-1150-17
170 mm

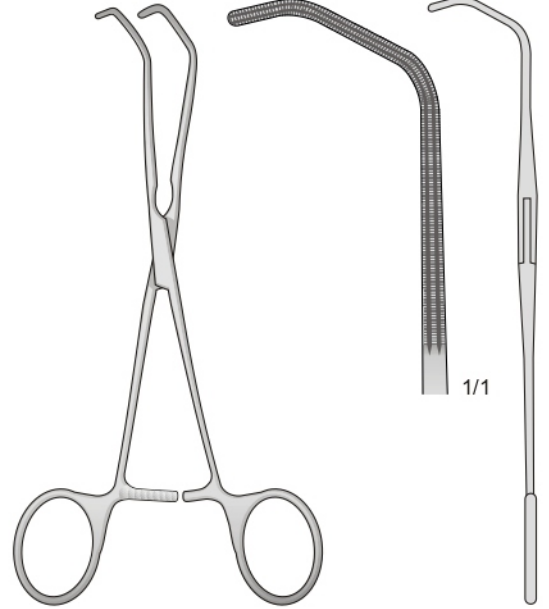

BECK
06-1160-17
170 mm

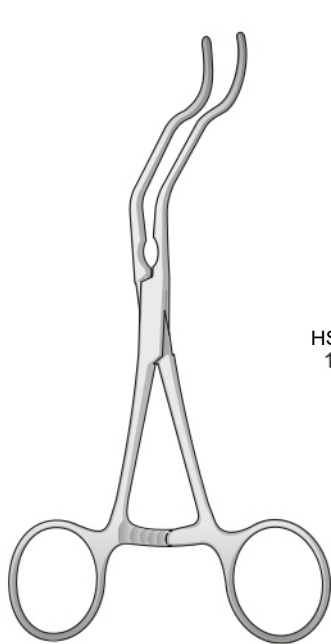

GREGORY
HS-5099



HS-5099-1
140 mm



HS-5099-2
160 mm

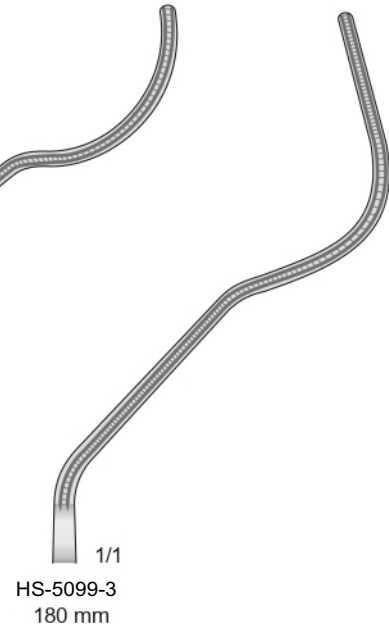

HS-5099-3
180 mm

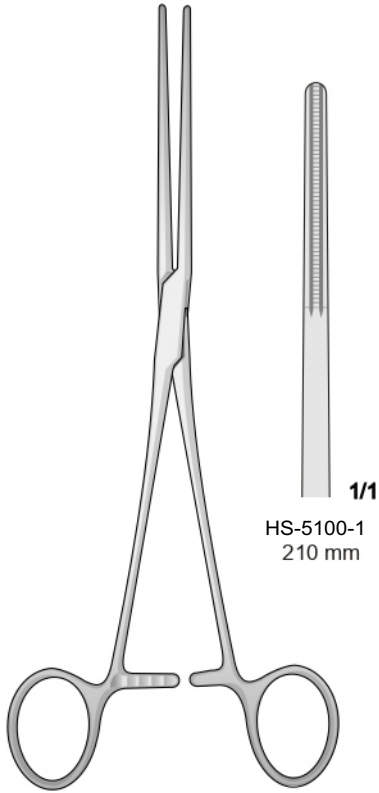

POTTS
 HS-5100

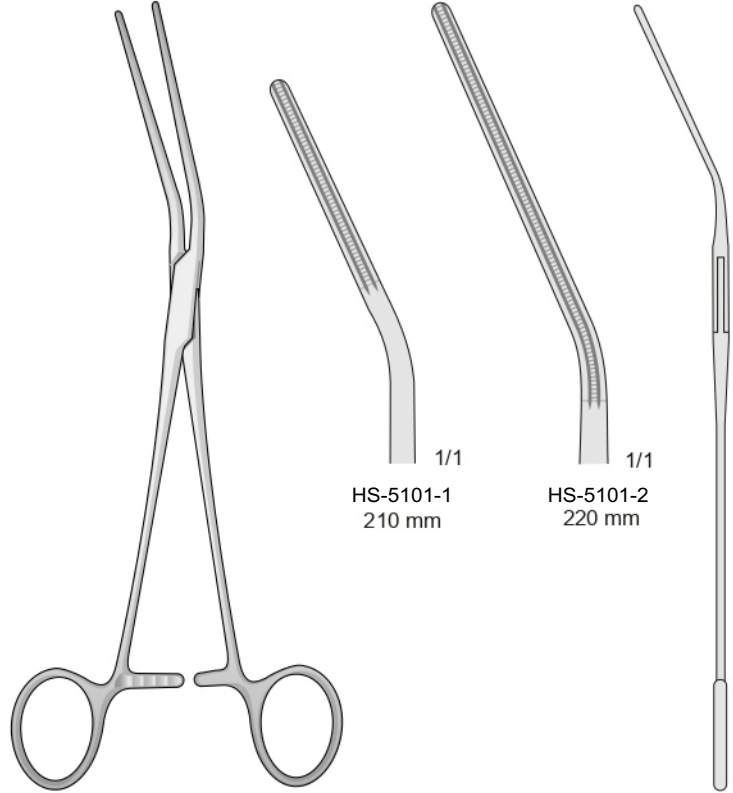

POTTS
 HS-5101

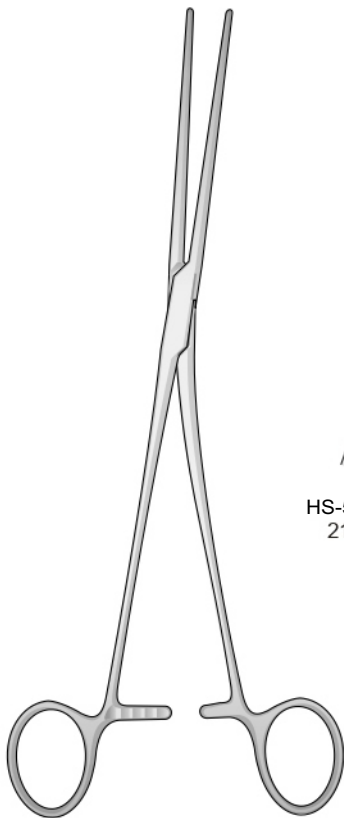

POTTS
 HS-5102

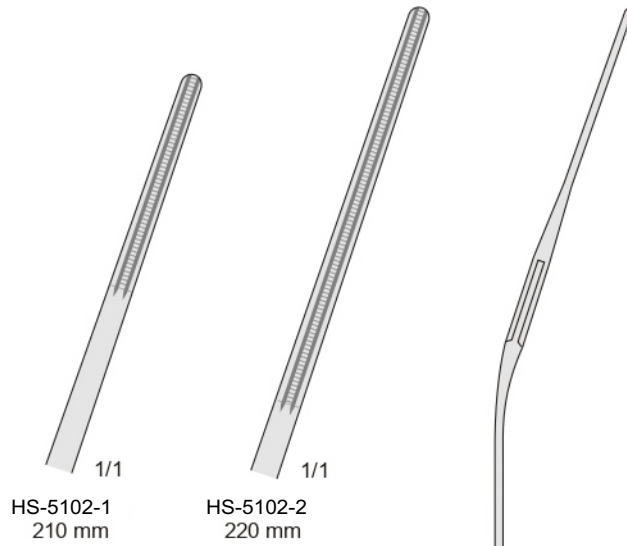

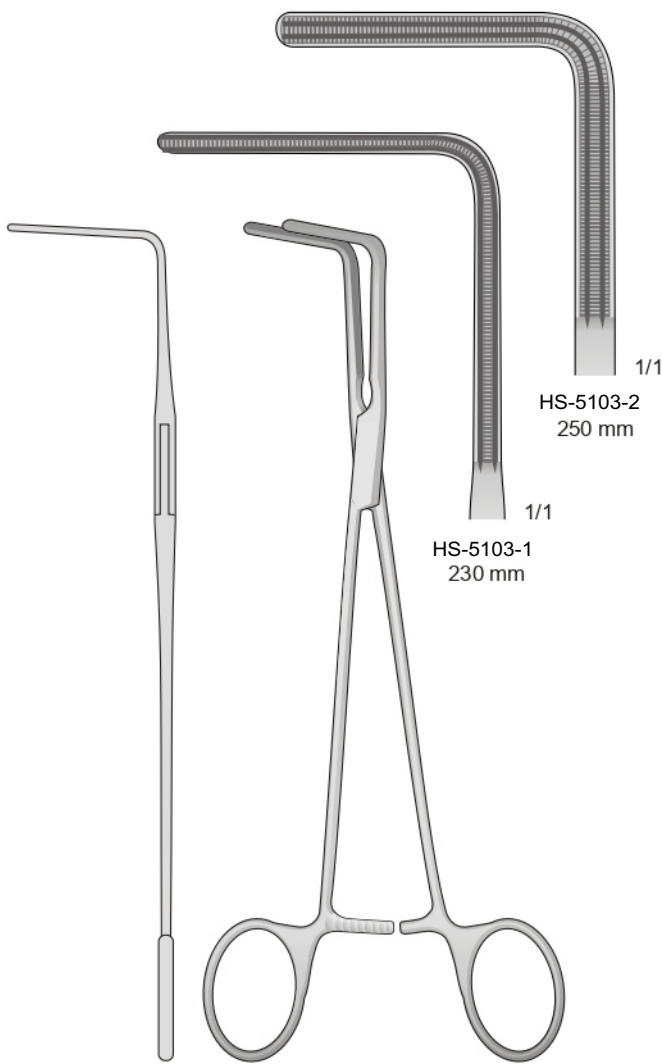

LEES
HS-5103

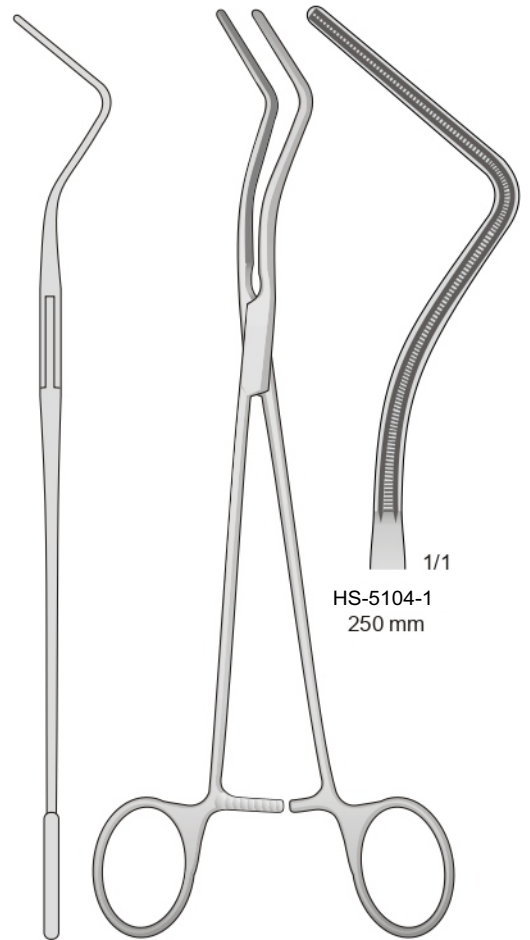

LEES
HS-5104
250 mm

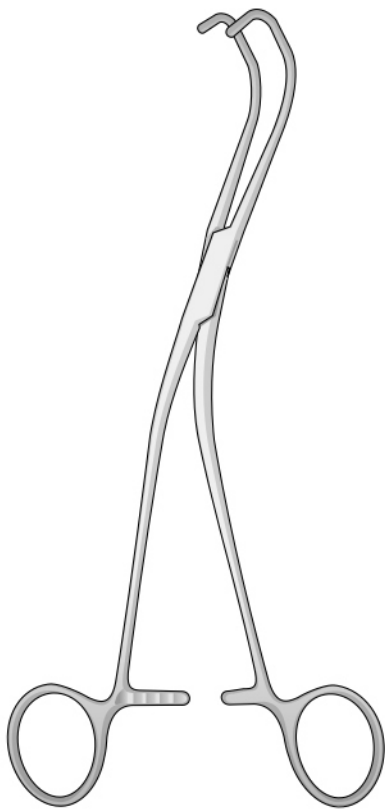

LAMBERT-KAY
HS-5105

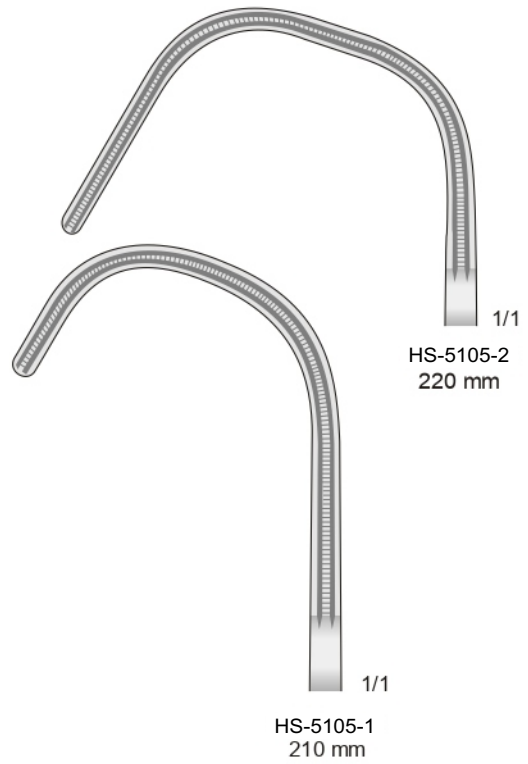
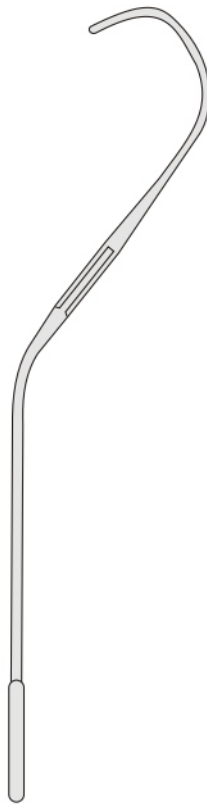

HS-5105-1
210 mm

HS-5105-2
220 mm

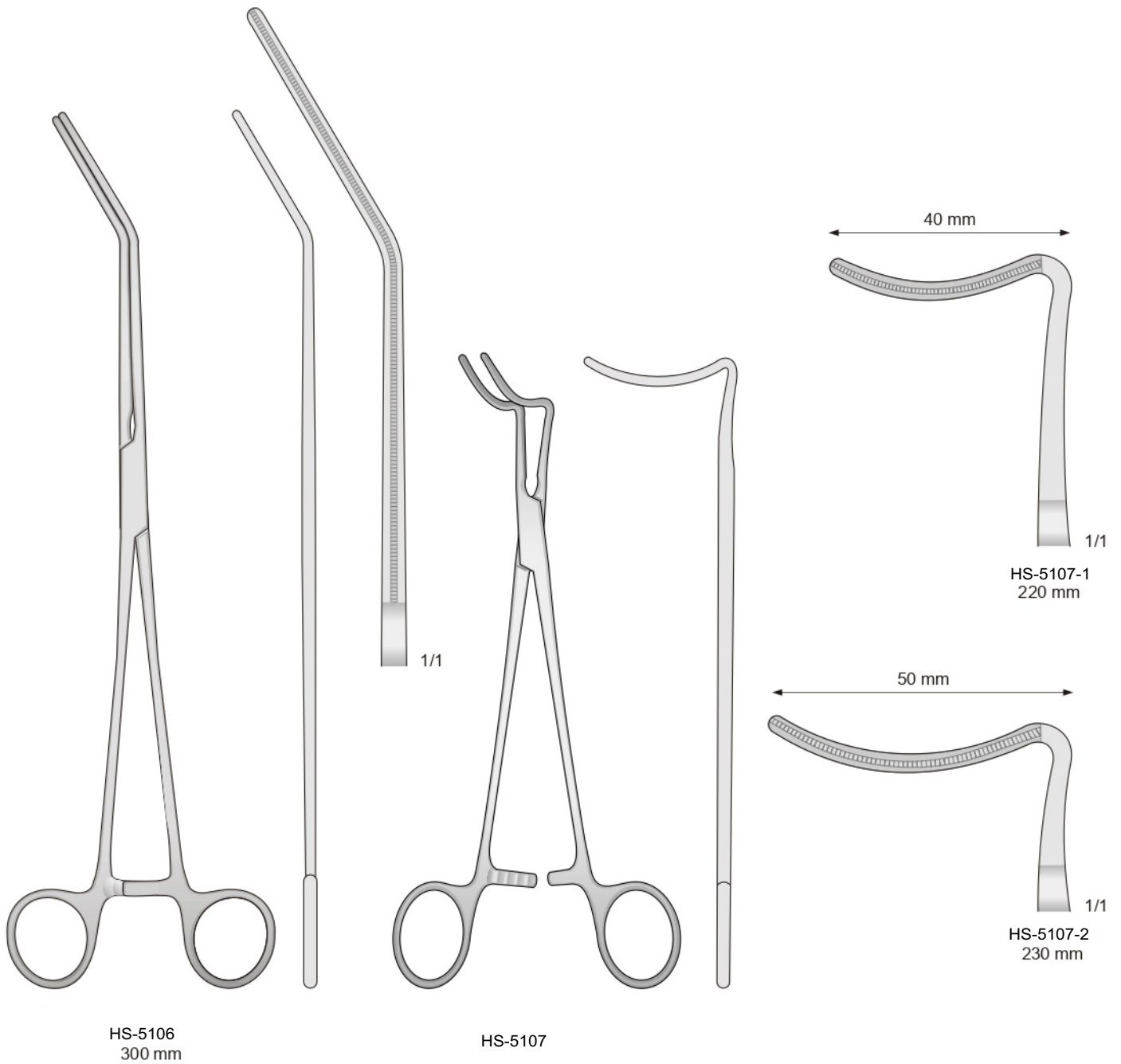

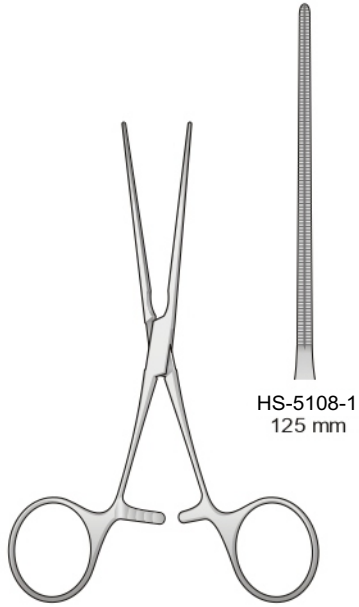

COOLEY
HS-5108

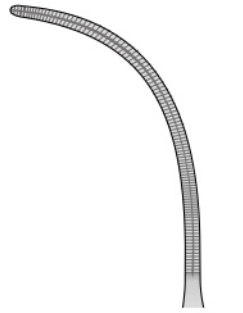

HS-5108-2
115 mm

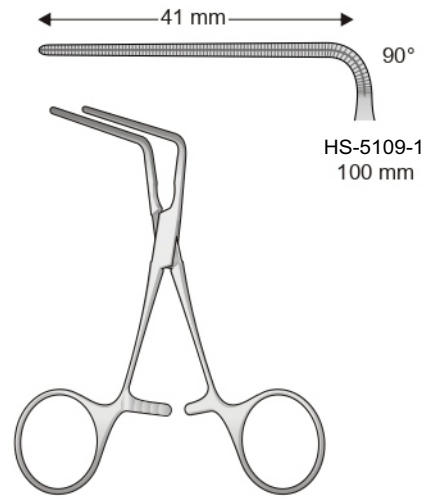

COOLEY
HS-5109

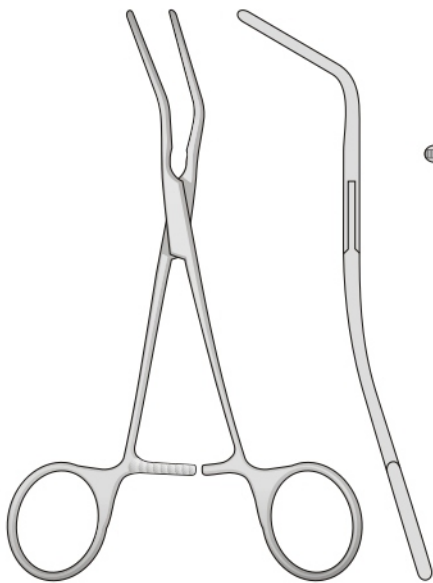

COOLEY
HS-5110

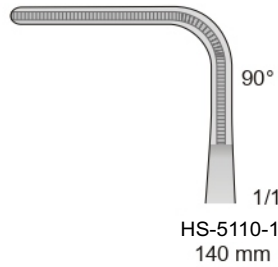

HS-5110-1
140 mm

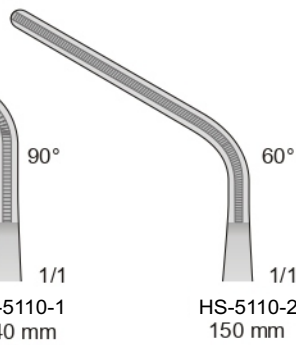

HS-5110-2
150 mm

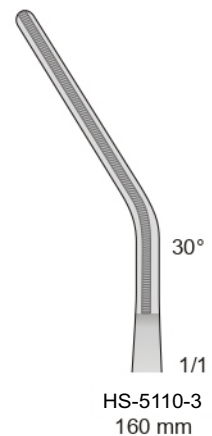

HS-5110-3
160 mm

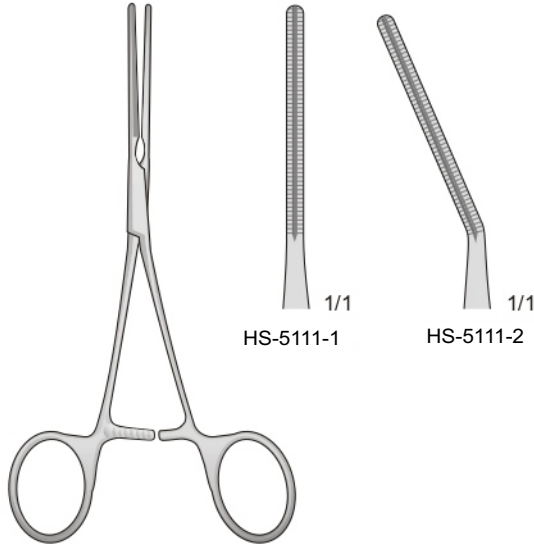

COOLEY
HS-5111
140 mm

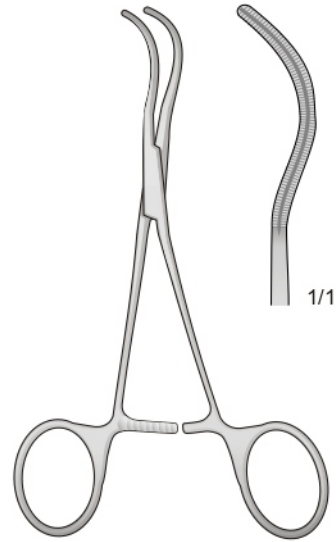

COOLEY
HS-5112
140 mm

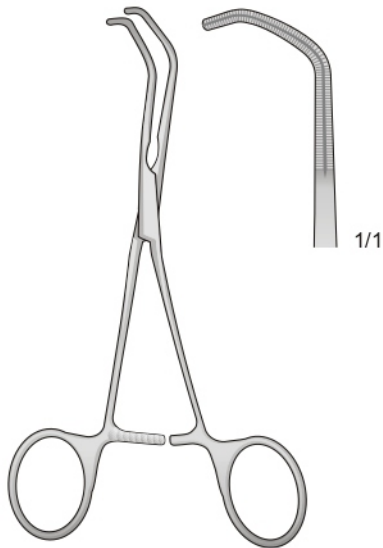

COOLEY
HS-5113
140 mm

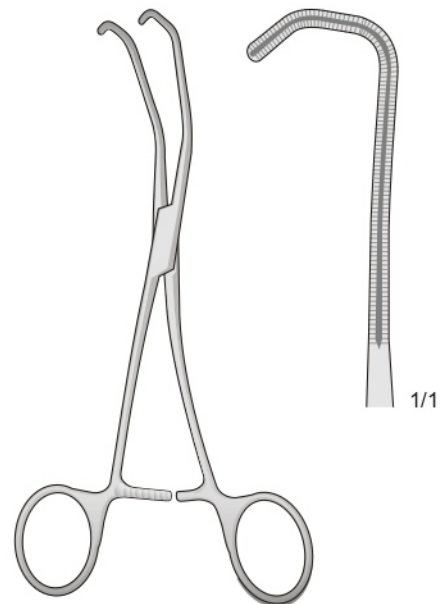

COOLEY
HS-5114
160 mm

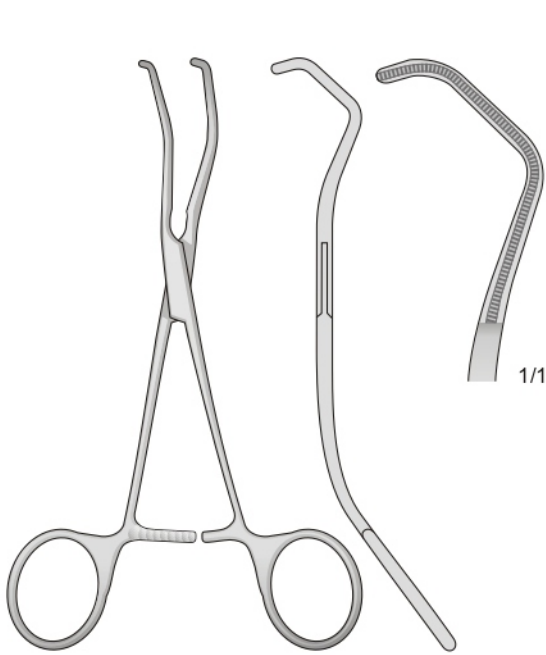

COOLEY
 HS-5115
 160 mm

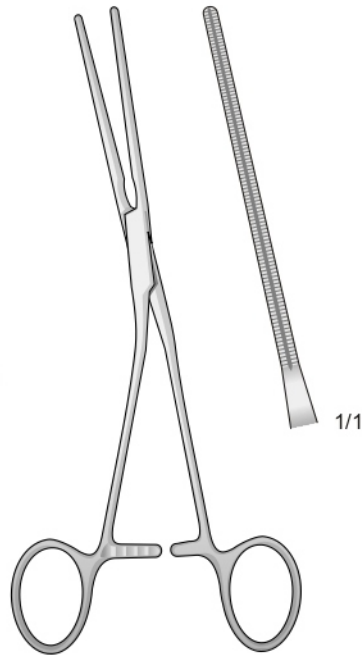

COOLEY
 HS-5116
 170 mm

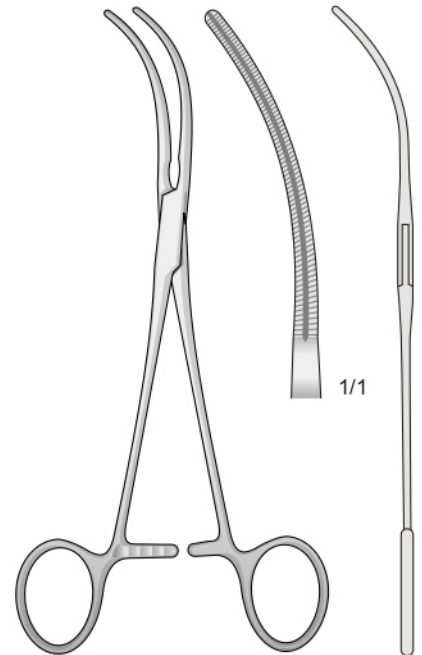

COOLEY
 HS-5117
 170 mm

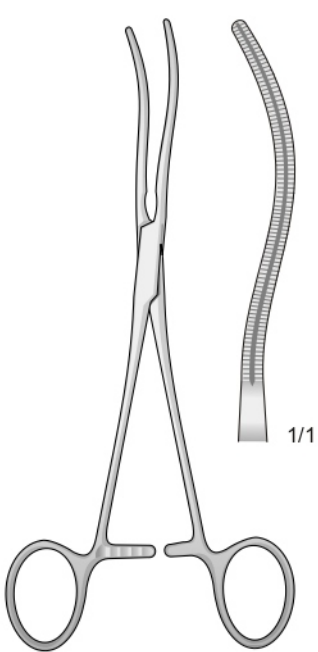

COOLEY
 HS-5118
 170 mm

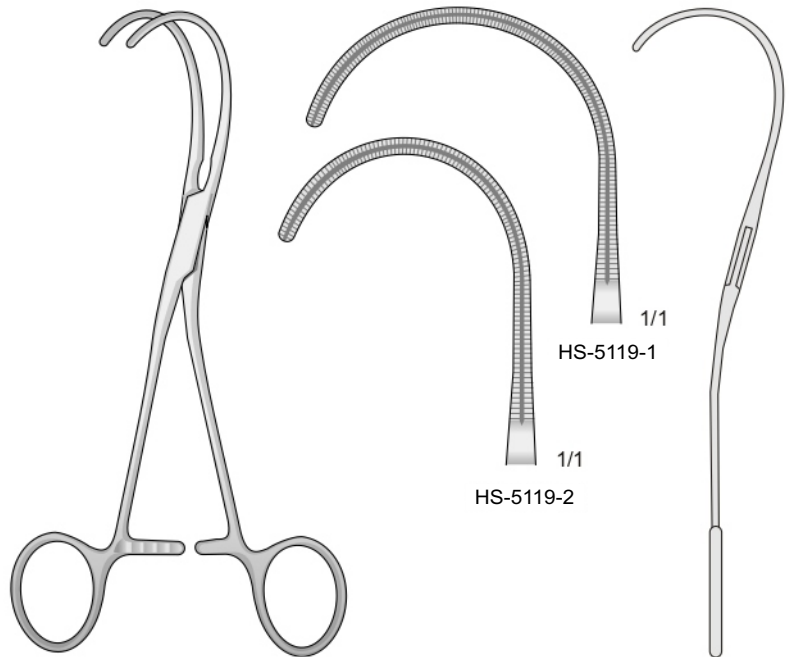

COOLEY
 HS-5119
 170 mm

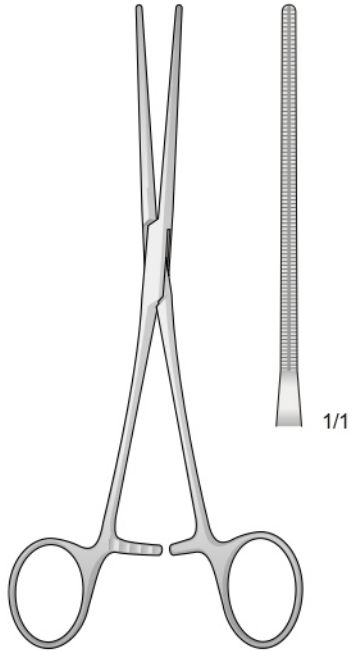

COOLEY
HS-5120
170 mm

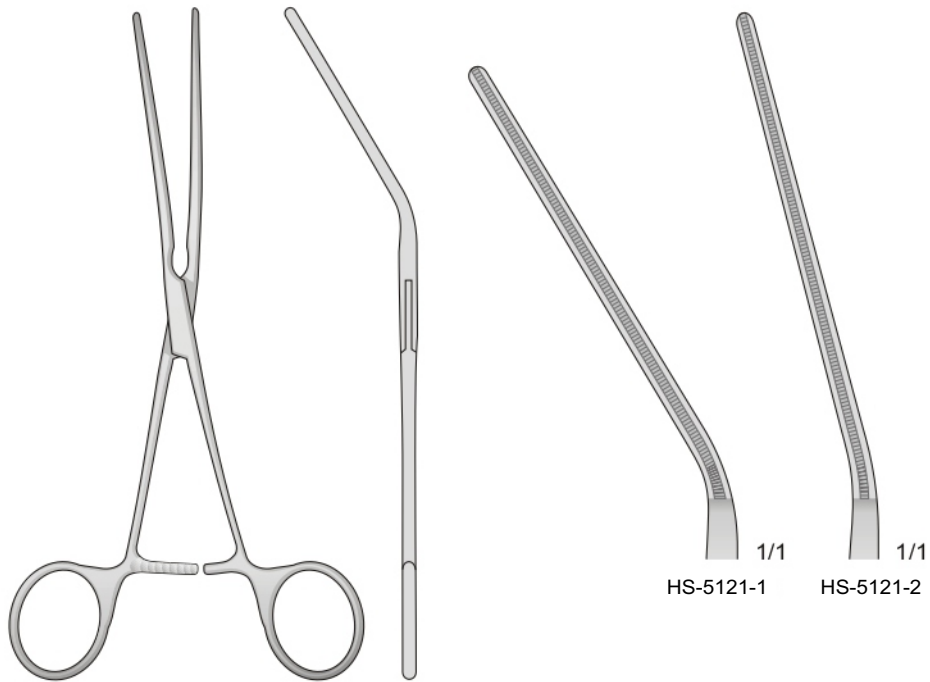

LELAND - JONES
HS-5121
190 mm

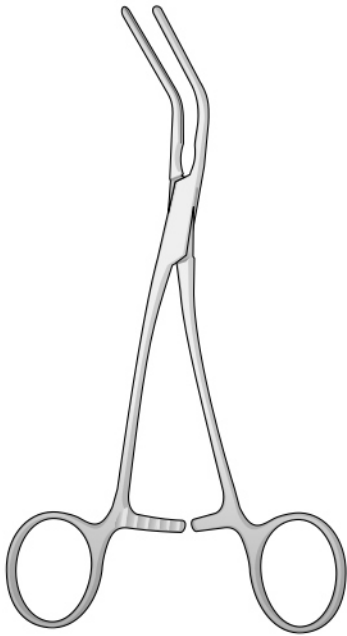

COOLEY
HS-5122

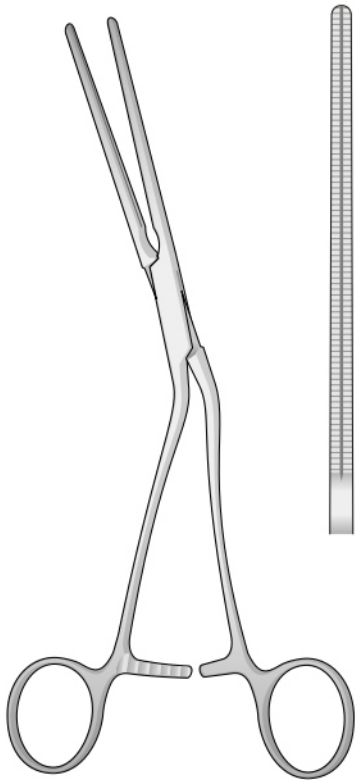
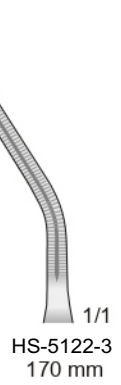
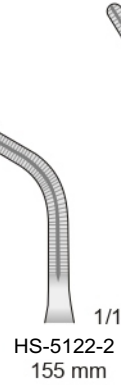
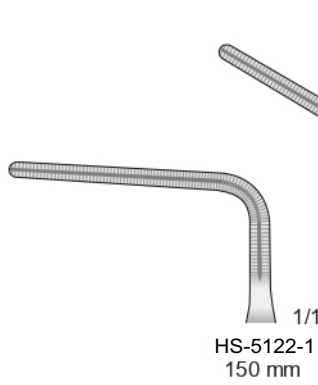
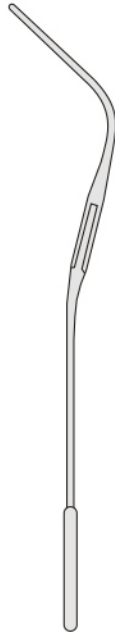

COOLEY
HS-5123
210 mm

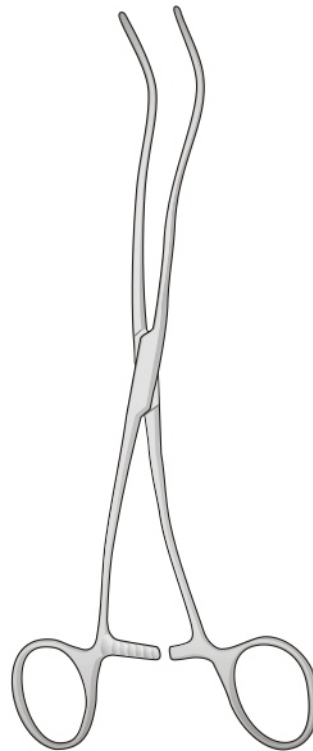
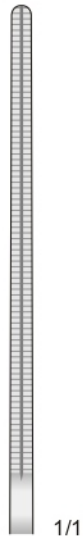

COOLEY
HS-5124
200 mm

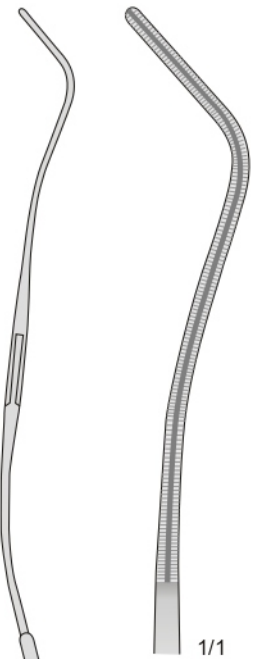

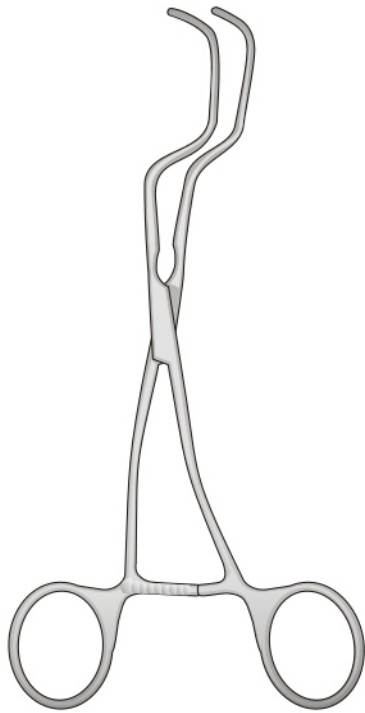

DALE
HS-5125
185 mm

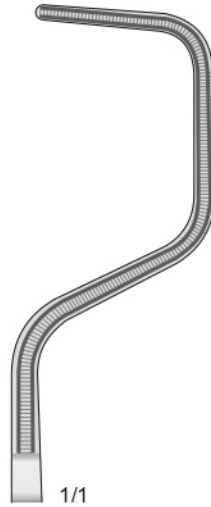

1/1
HS-5125-1
185 mm

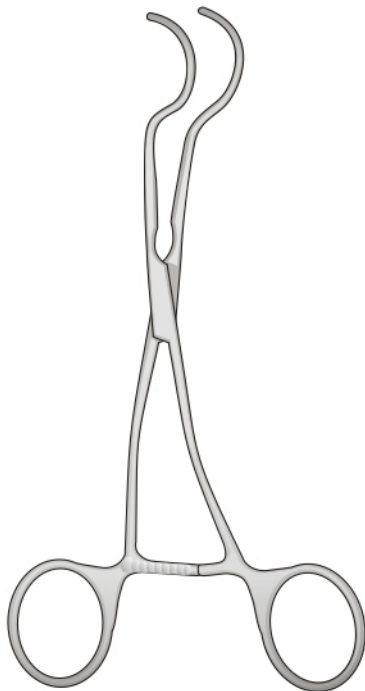

DALE
HS-5126

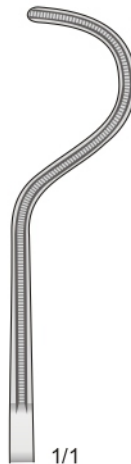

1/1
HS-5126-1
170 mm

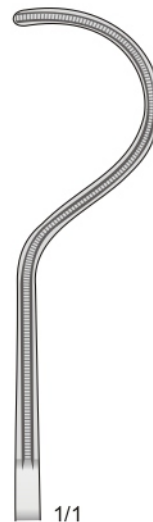

1/1
HS-5126-2
175 mm



1/1
HS-5126-3
185 mm

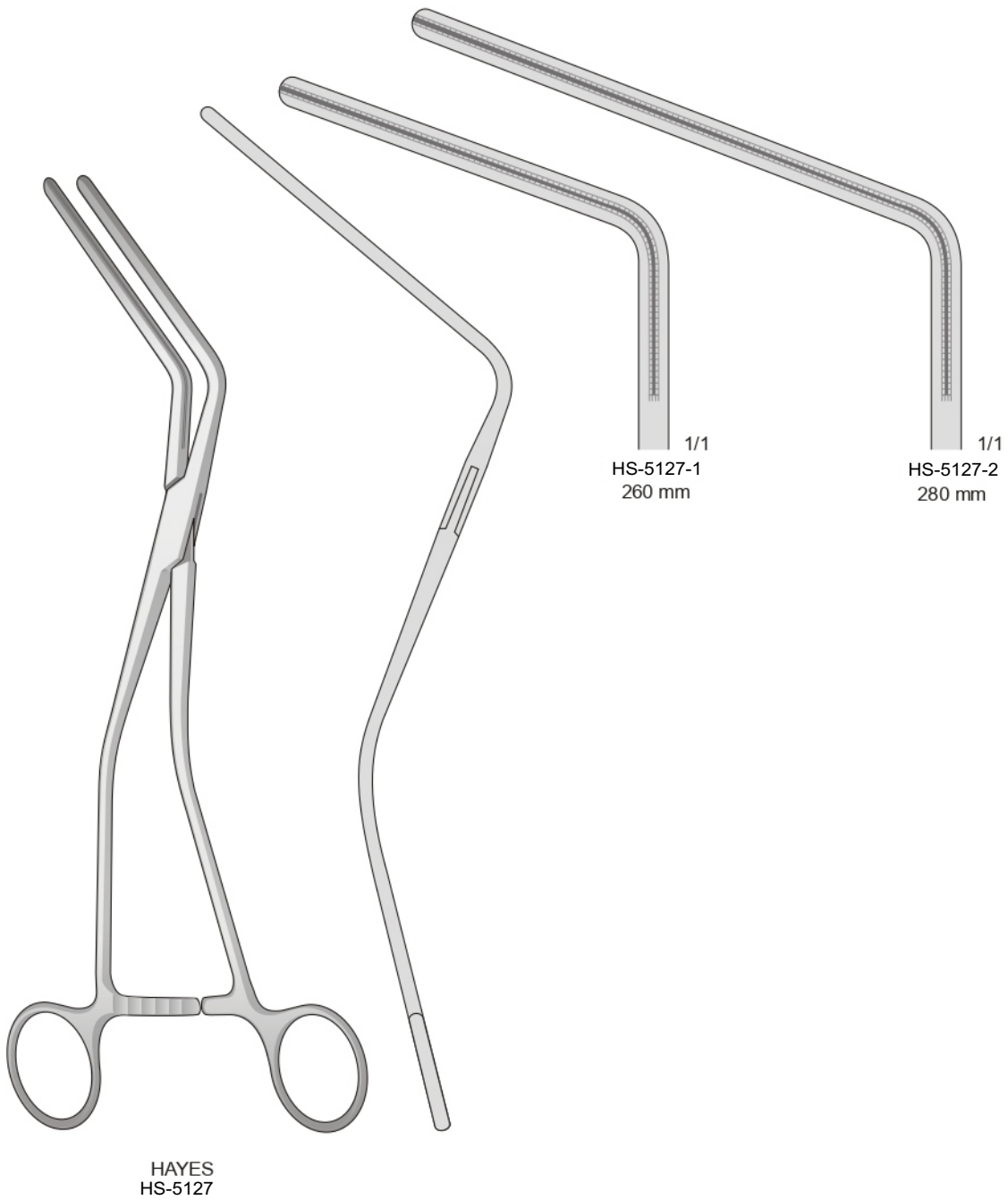

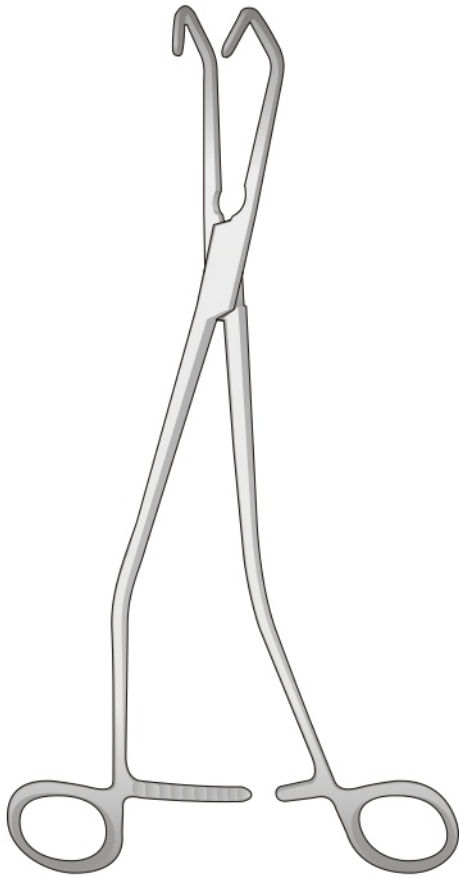

HOPT
HS-5128-1 - 230 mm
HS-5128-2 - 235 mm
HS-5128-3 - 240 mm



1/1
HS-5128-1
40 mm



1/1
HS-5128-2
50 mm



1/1
HS-5128-3
60 mm

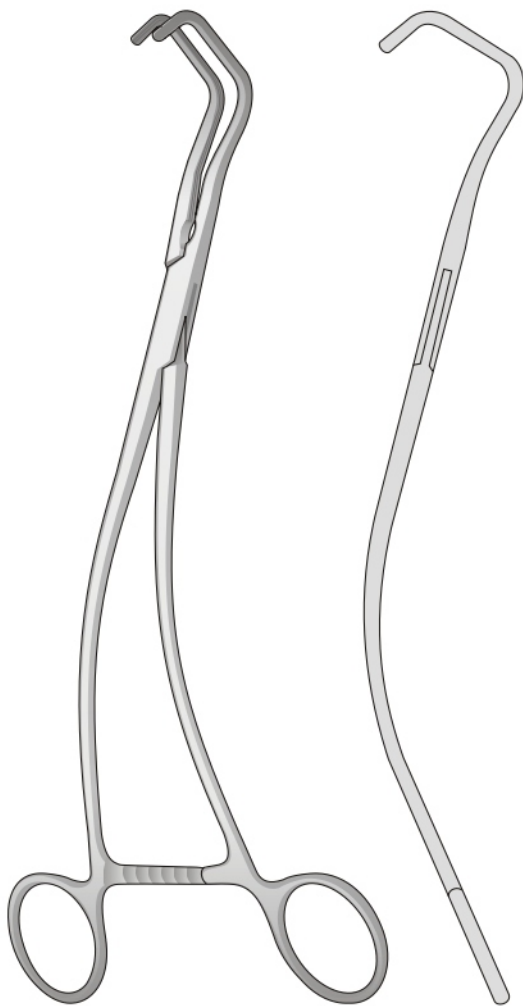

URO-TANGENTIAL
HS-5129
260 mm

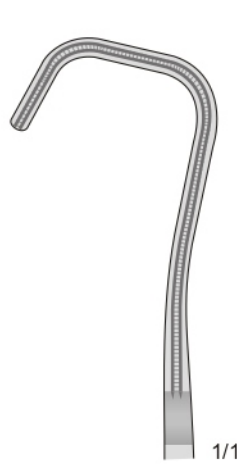

HS-5129-1
260 mm

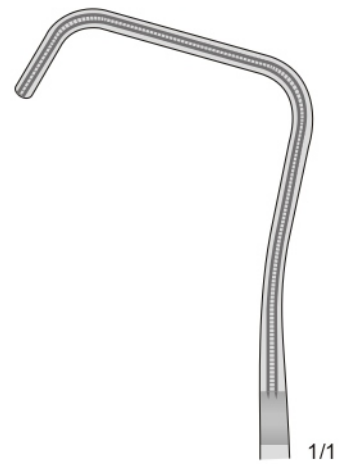

HS-5129-2
260 mm



Atraumatic Vessel Clamps

Per bambini
For children
Kinderklemmen
Pour enfants
Para niños

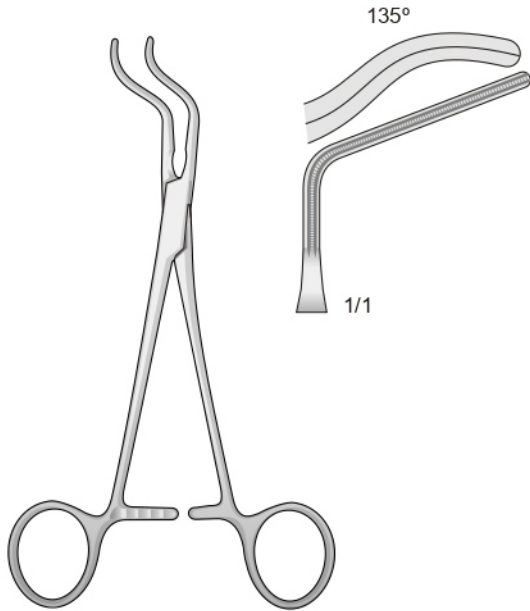

SUBRAMANIAN-MINIATURE
06-1500-15
155 mm

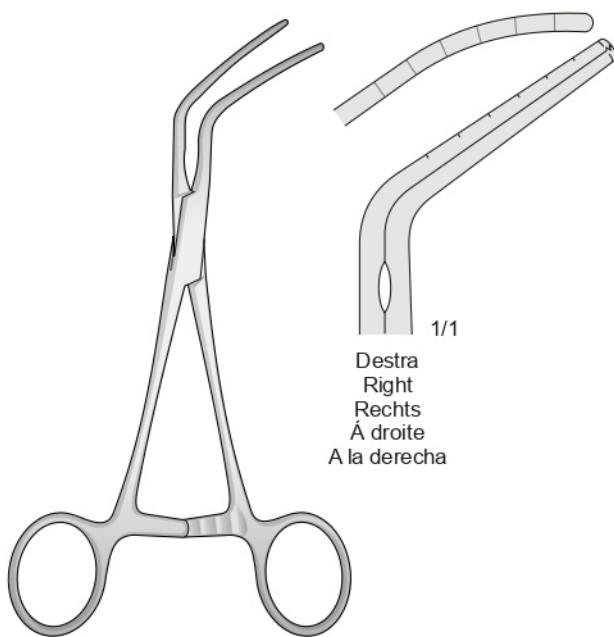

SUBRAMANIAN
06-1510-16
160 mm

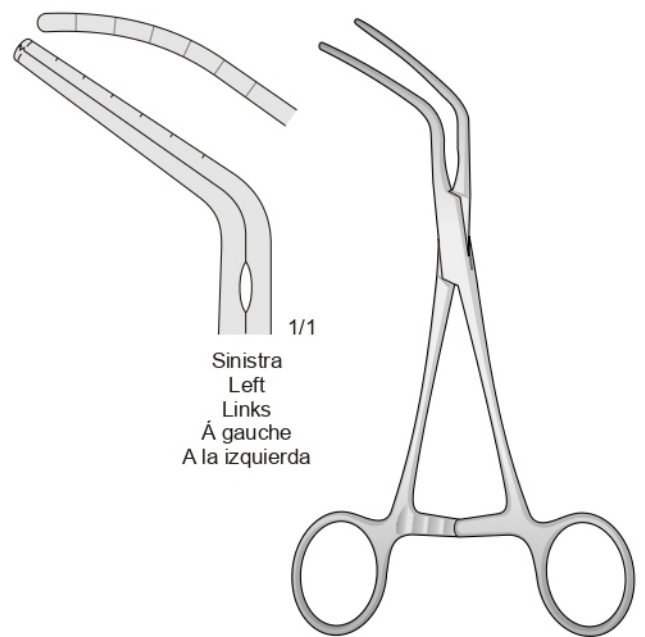

SUBRAMANIAN
06-1520-16
160 mm

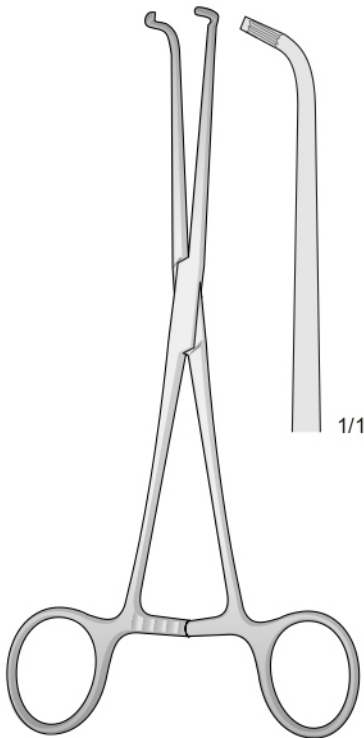

JAVID
06-1530-18
180 mm

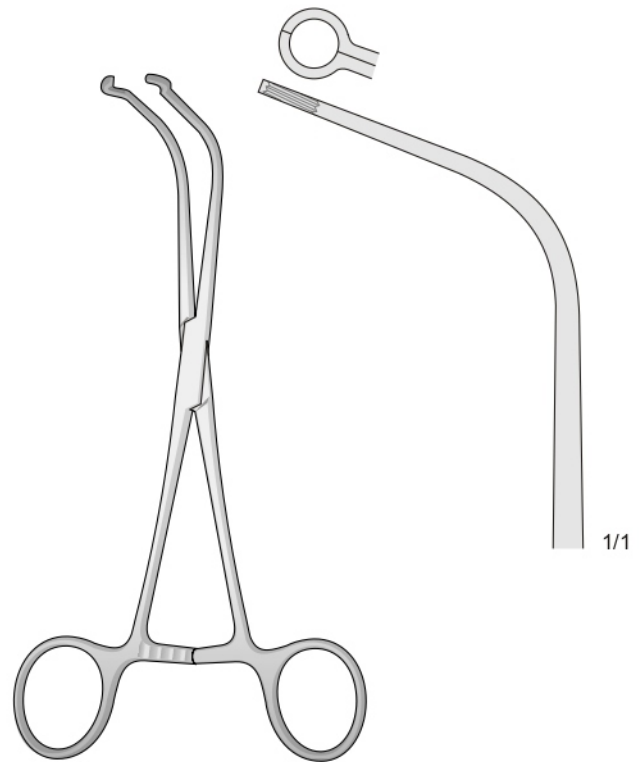

JAVID
06-1530-19
190 mm

Intestinal Forceps

Atraumatiche - Atraumatic - Atraumatische
Atraumatique - Atraumáticas

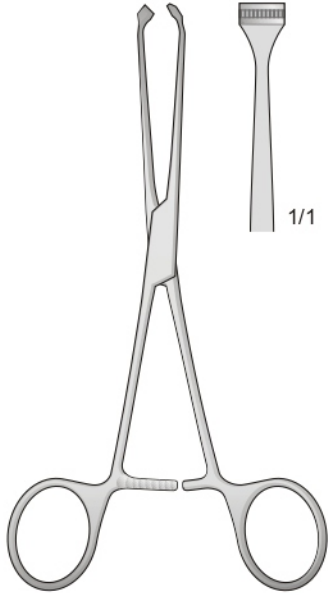

ALLIS
06-1540-15
150 mm

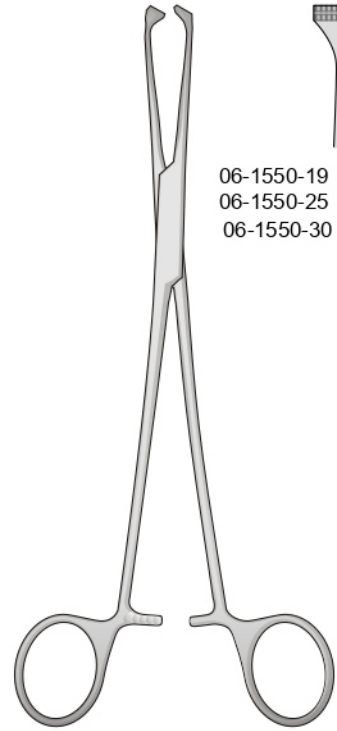

1/1
06-1550-19 - 190 mm
06-1550-25 - 250 mm
06-1550-30 - 300 mm

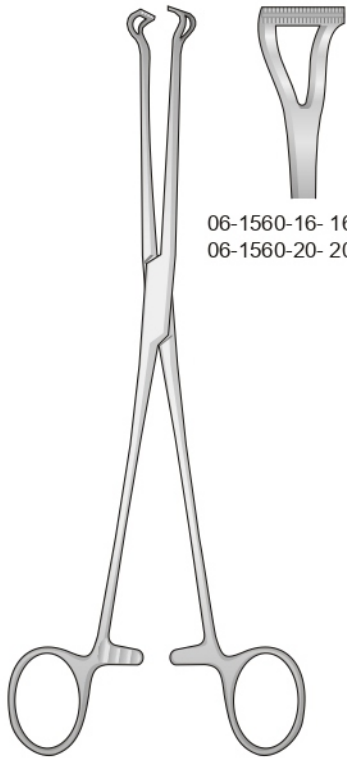

BABCOCK
06-1560

06-1560-16- 160 mm
06-1560-20- 200 mm

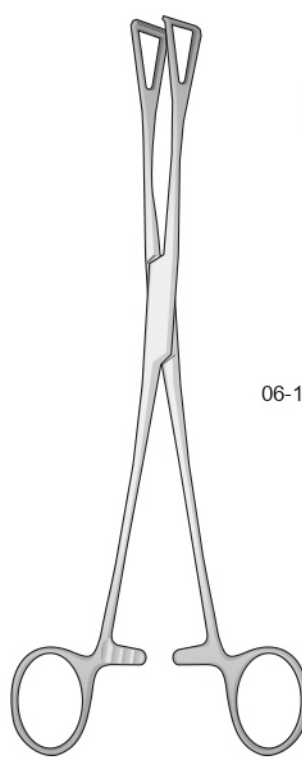

DUVAL
06-1570

14 mm
18 mm
06-1570-01- 200 mm
06-1570-02- 200 mm

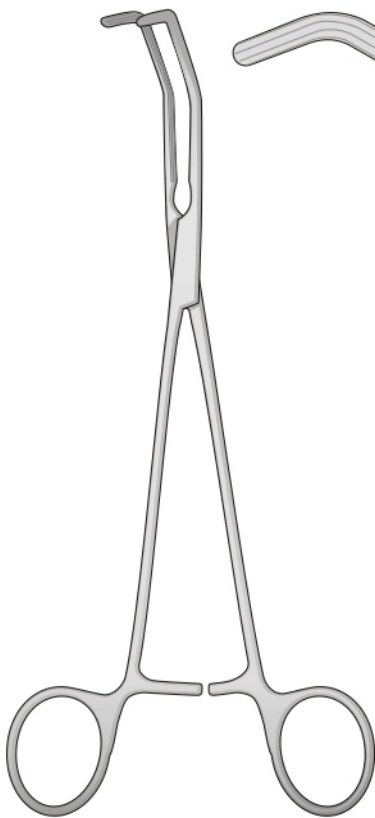

PRICE - THOMAS
06-1580
220 mm

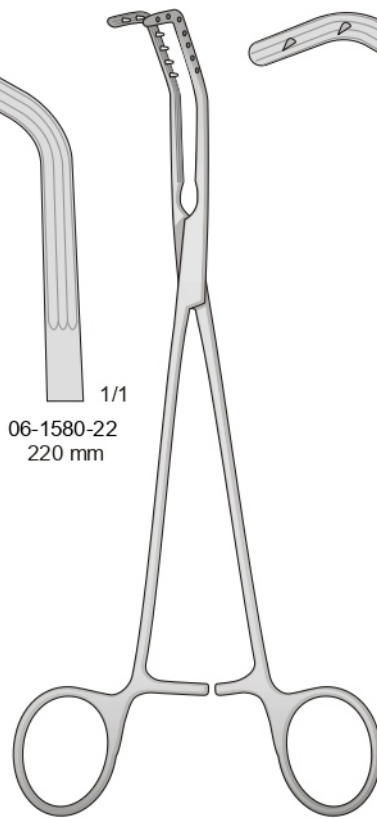

PRICE - THOMAS
06-1590

1/1
06-1580-22
220 mm

1/1
06-1590-01
220 mm

1/1
06-1590-02
220 mm

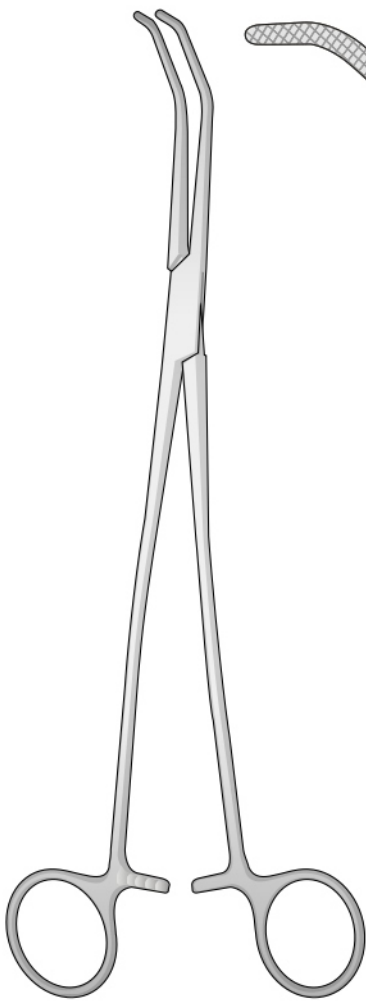

SATINSKY
06-1600
260 mm

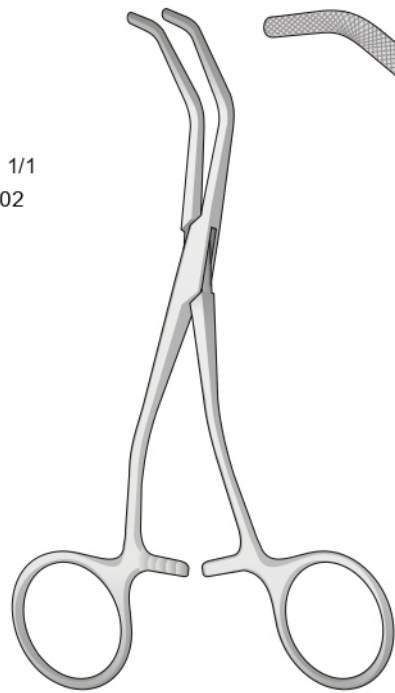
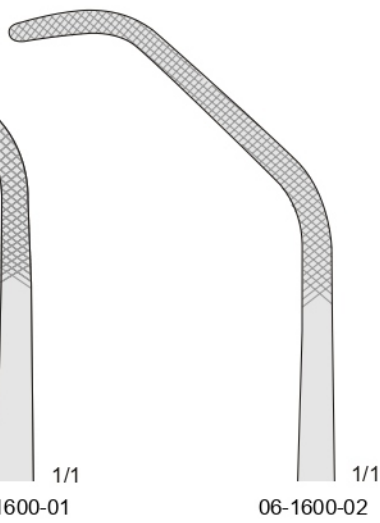
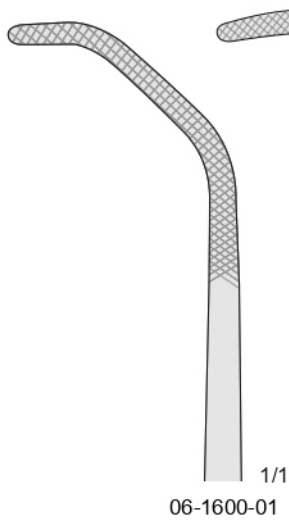

BABY-SATINSKY
06-1610
150 mm

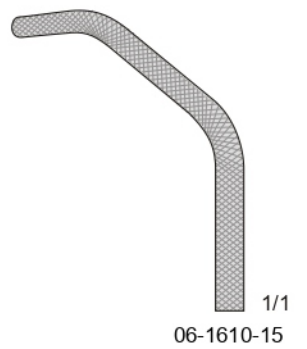

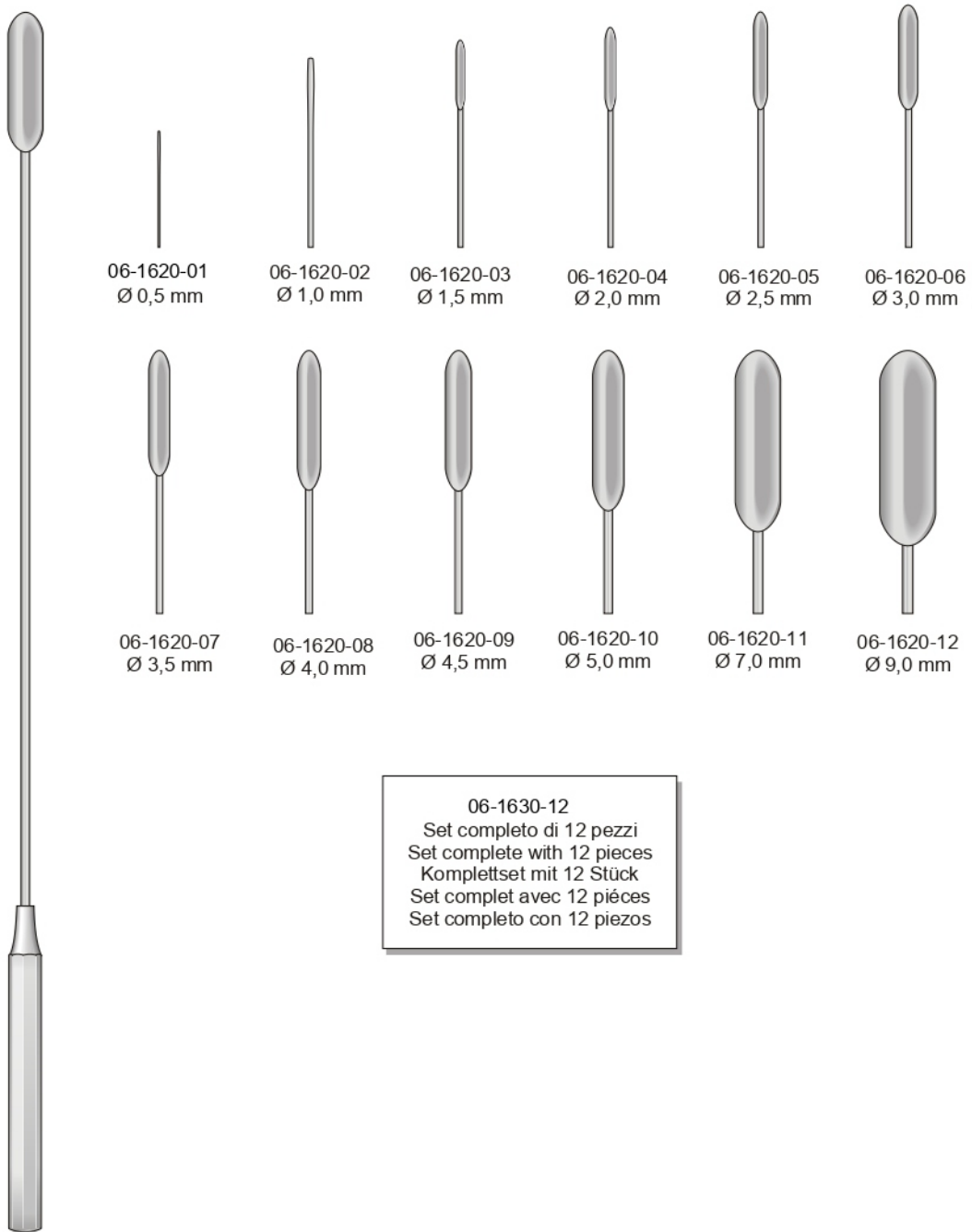

06-1620-01
Ø 0,5 mm

06-1620-02
Ø 1,0 mm

06-1620-03
Ø 1,5 mm

06-1620-04
Ø 2,0 mm

06-1620-05
Ø 2,5 mm

06-1620-06
Ø 3,0 mm

06-1620-07
Ø 3,5 mm

06-1620-08
Ø 4,0 mm

06-1620-09
Ø 4,5 mm

06-1620-10
Ø 5,0 mm

06-1620-11
Ø 7,0 mm

06-1620-12
Ø 9,0 mm

06-1630-12
Set completo di 12 pezzi
Set complete with 12 pieces
Komplettset mit 12 Stück
Set complet avec 12 pièces
Set completo con 12 piezas

DE BAKEY
06-1620
190 mm



- 06-1640-01- 140 mm - Ø 1,0
- 06-1640-02- 140 mm - Ø 1,5
- 06-1640-03- 140 mm - Ø 2,0
- 06-1640-04- 140 mm - Ø 2,5
- 06-1640-05- 140 mm - Ø 3,0
- 06-1640-06- 140 mm - Ø 3,5
- 06-1640-07- 140 mm - Ø 4,0
- 06-1640-08- 140 mm - Ø 4,5
- 06-1640-09- 140 mm - Ø 5,0

- 06-1640-10- 210 mm - Ø 1,0
- 06-1640-11- 210 mm - Ø 1,5
- 06-1640-12- 210 mm - Ø 2,0
- 06-1640-13- 210 mm - Ø 2,5
- 06-1640-14- 210 mm - Ø 3,0
- 06-1640-15- 210 mm - Ø 3,5
- 06-1640-16- 210 mm - Ø 4,0
- 06-1640-17- 210 mm - Ø 4,5
- 06-1640-18- 210 mm - Ø 5,0

06-1650-09
Set completo di 9 pezzi
Set complete with 9 pieces
Komplettsset mit 9 Stück
Saet complet avec 9 pièces
Set completo con 9 piezas

06-1660-09
Set completo di 9 pezzi
Set complete with 9 pieces
Komplettsset mit 9 Stück
Saet complet avec 9 pièces
Set completo con 9 piezas

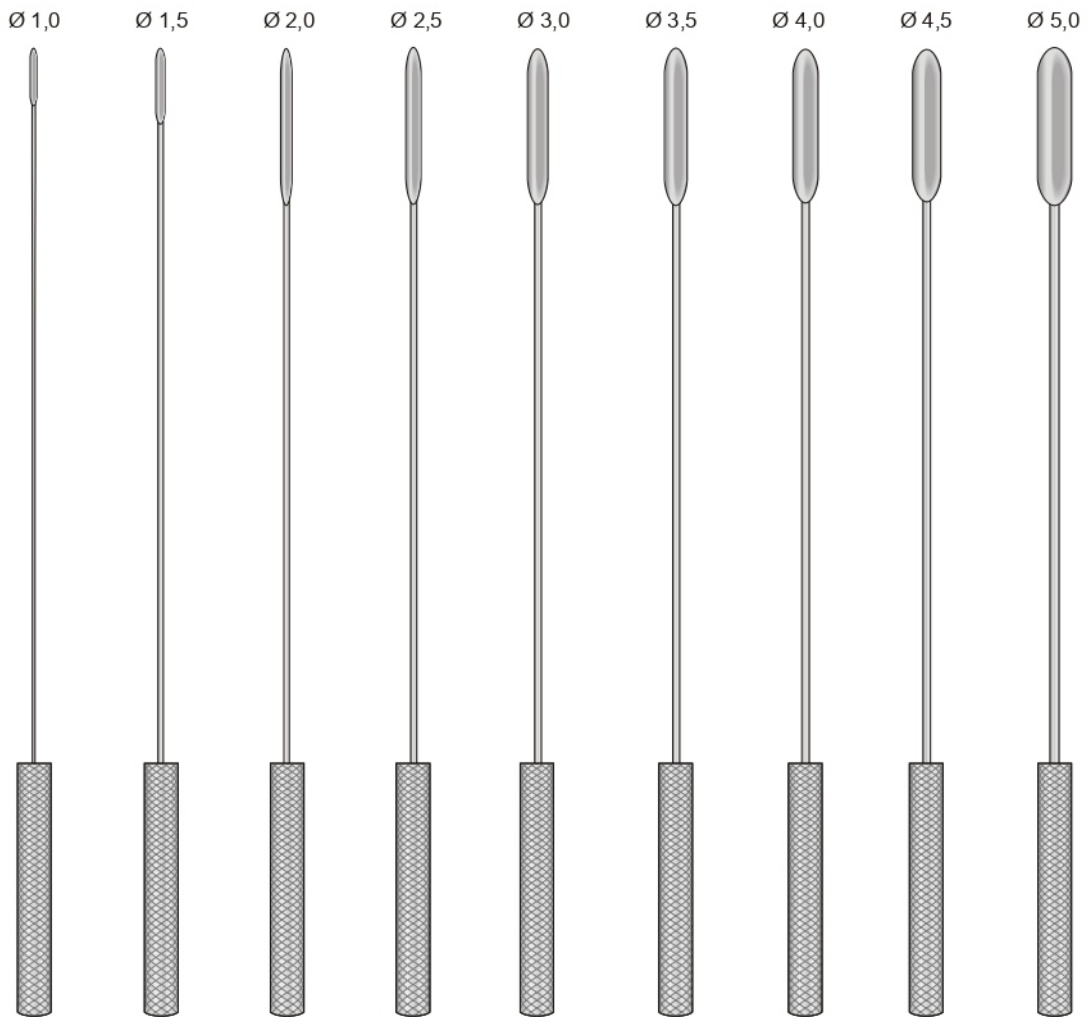

GARRETT
06-1640



VOLLMAR
06-1670
500 mm

Ø 2 mm
○ 1/1
06-1670-01

Ø 3 mm
○ 1/1
06-1670-02

Ø 4 mm
○ 1/1
06-1670-03

Ø 6 mm
○ 1/1
06-1670-04

Ø 7 mm
○ 1/1
06-1670-05

Ø 8,5 mm
○ 1/1
06-1670-06

Ø 10 mm
○ 1/1
06-1670-07

Ø 12 mm
○ 1/1
06-1670-08

Ø 14 mm
○ 1/1
06-1670-09



06-1680-12
120 mm

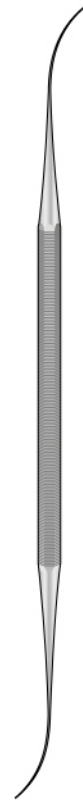

VARADY
06-1690-01
180 mm



VARADY
06-1690-02
180 mm



VARADY
06-1690-03
180 mm

Aghi vascolari malleabili - Gefäßspülkanülen
Ø 3 mm Ø 4 mm Ø 5 mm Ø 6 mm



SCHMID
06-1700-01
150 mm



SCHMID
06-1700-02
150 mm



SCHMID
06-1700-03
150 mm



SCHMID
06-1700-04
150 mm



AP. 9-45 mm

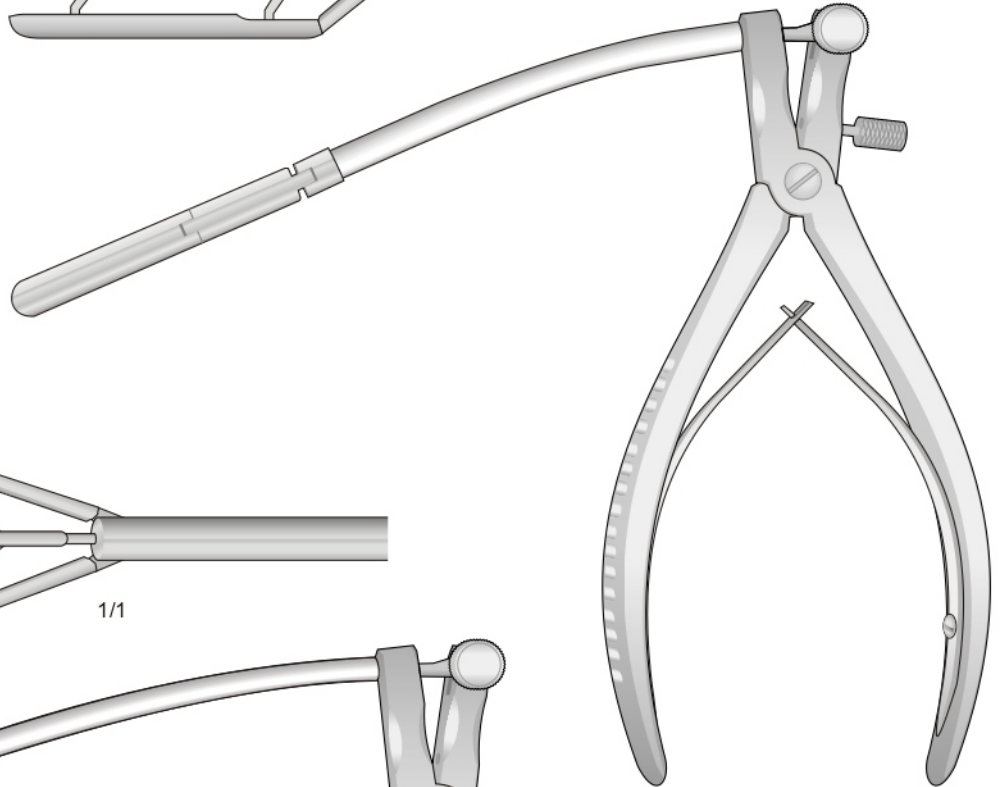
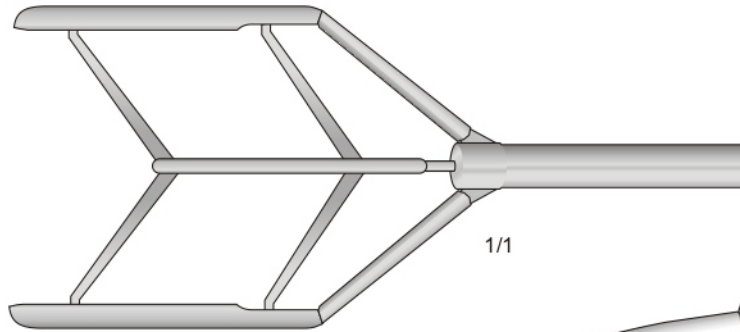

TUBBS
06-1720

AP. 8-15 mm

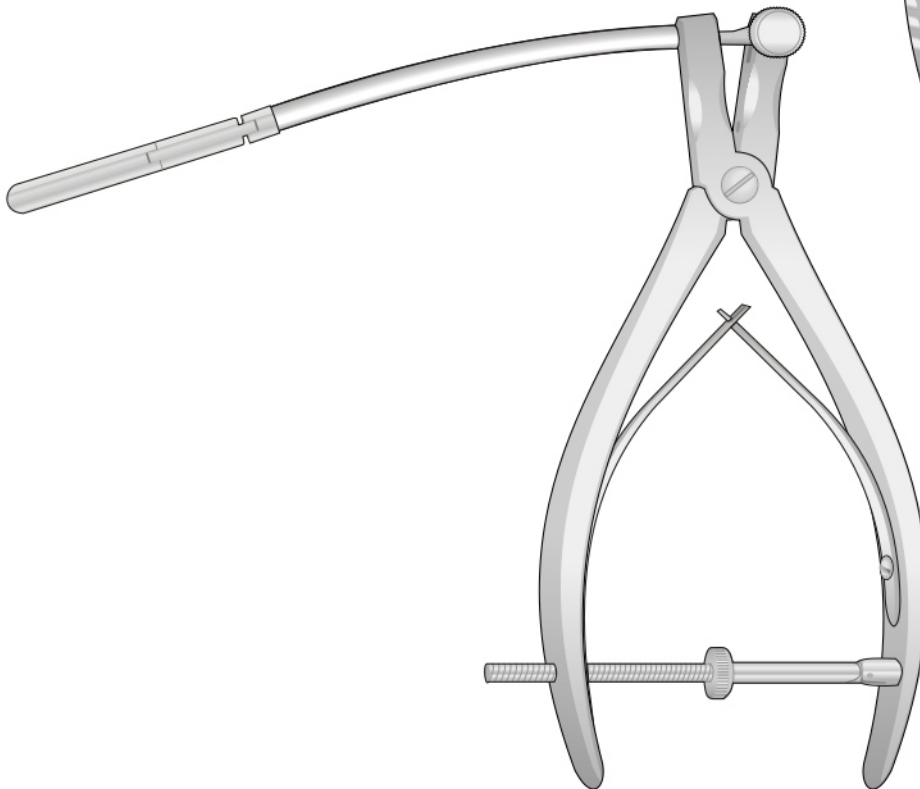
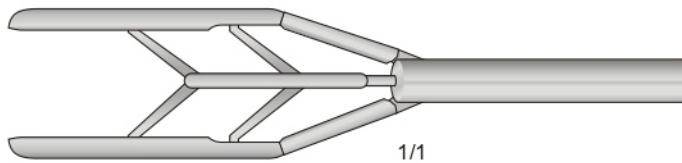

COOLEY
06-1710

**Manufacturer & Exporter
Of Surgical, Dental & Beauty Instruments.**



Health Fast Surgical

Surgical Manufacturer Company

+92 (342) 880 9017

+92 (342) 880 9017

info@healthfastsurgical.com

www.healthfastsurgical.com

Dogra Khurd, P.O Harrar Sialkot-51310 Pakistan.



ISO
9001:2008

