

# Surgical

INSTRUMENTS CATALOGUE



[www.healthfastsurgical.com](http://www.healthfastsurgical.com)

***Addendum***



# Health Fast Surgical

Surgical Manufacturer Company

Diagnostik-Bestecke - Diagnostic Sets  
Set Diagnostica - Set Diagnóstico  
Troussets à Diagnostic

Etui für McINTOSH Fig. 1-3  
Case for McINTOSH Fig. 1-3  
Cassetta per laringoscopio McINTOSH Fig. 1-3  
Estuche para McINTOSH Fig. 1-3  
Etui pour McINTOSH Fig. 1-3

Halogen - Alogeno



HS-4301  
Otoscopio completo con custodia



HS-4302

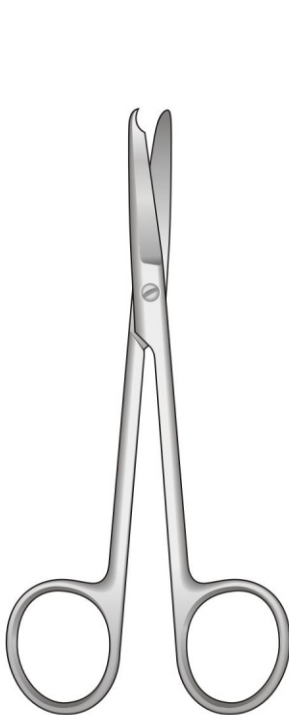

SPENCER  
HS-4303  
120 mm

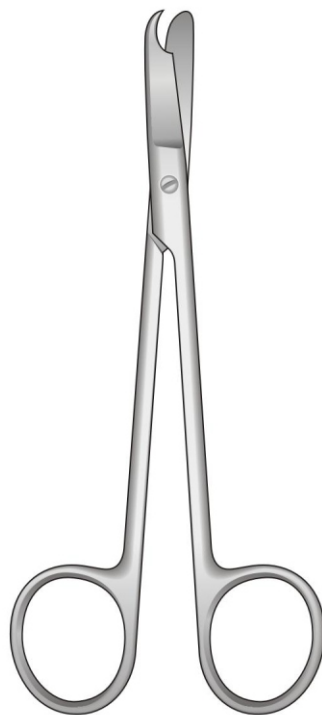

LITTAUER  
HS-4304  
140 mm

Wellenschliff  
TC

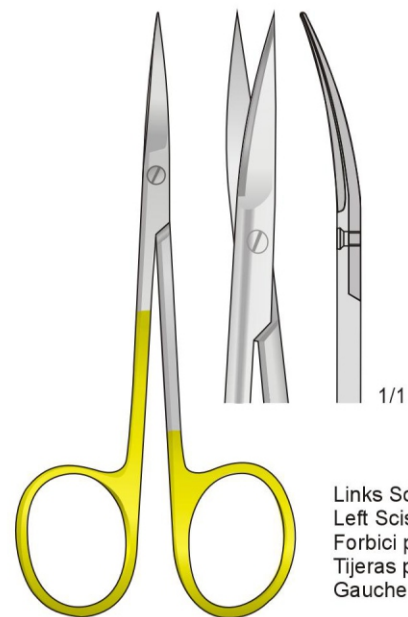

IRIS  
HS-4305  
110 mm

Links Scheren  
Left Scissors  
Forbici per mancini  
Tijeras para zurdos  
Gauche Ciseaux



**"Ribbon type"**

Mit großen Ringen  
 With large rings  
 Forbici ad anelli grandi  
 Con anillos especialmente grandes  
 avec larges anneaux

Iris scissors

Blepharoplasty  
 Blefaroplastica

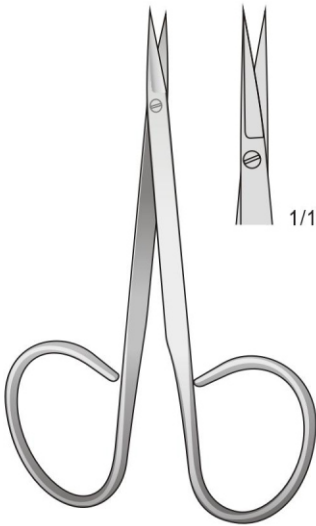

HS-4306  
95 mm

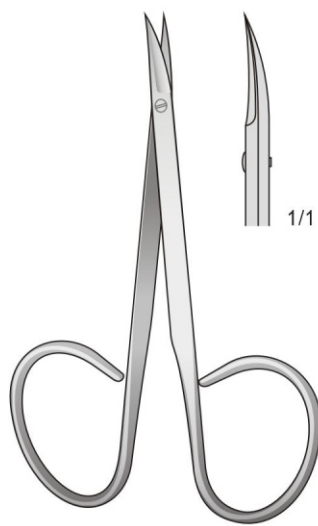

HS-4307  
95 mm

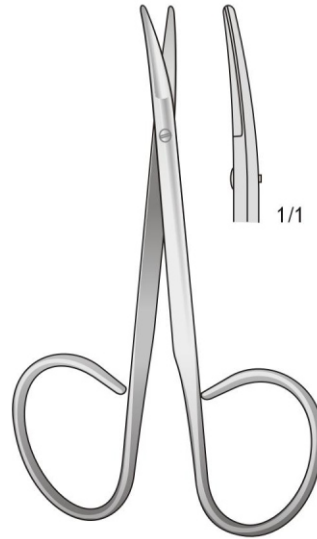

HS-4308  
95 mm

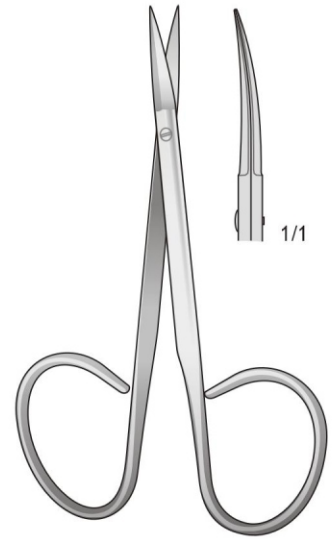

HS-4309  
105 mm

Iris scissors

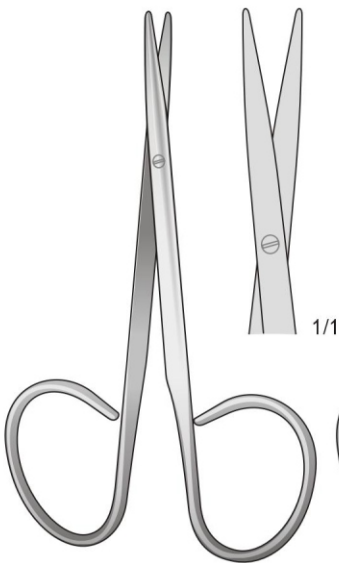

HS-4310  
100 mm

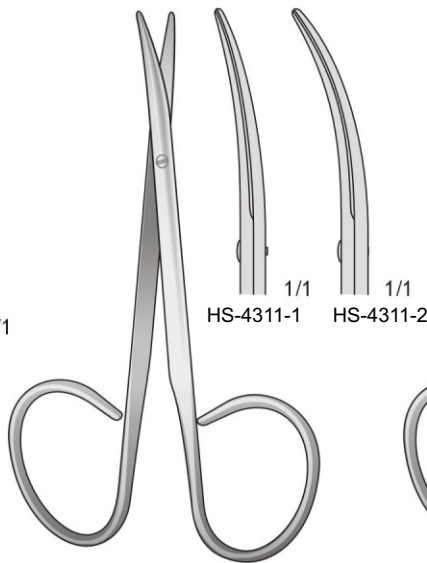

HS-4311  
100 mm

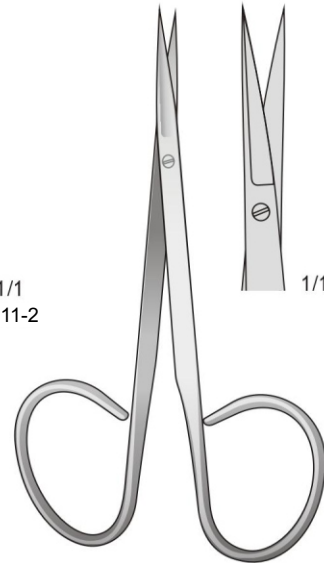

HS-4312  
105 mm

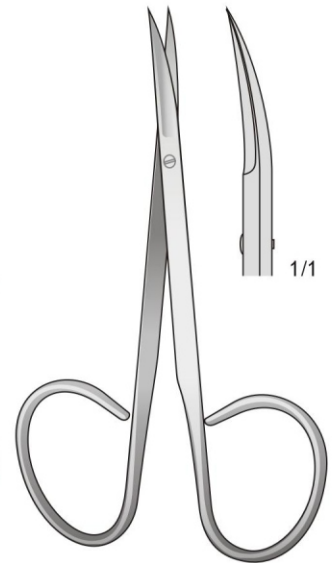

HS-4313  
105 mm

**"Ribbon type"**

Mit großen Ringen  
With large rings  
Forbici ad anelli grandi  
Con anillos especialmente grandes  
avec larges anneaux

Spitz  
Sharp  
Acuta  
Aguda  
Pointu

Stumpf  
Blunt  
Smussa  
Romas  
Mousse

Gezahnt  
Serrated  
Dentellata  
Dentadas  
Dentelés

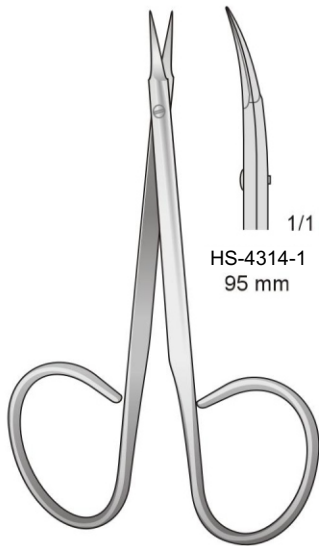

HS-4314  
STITCH

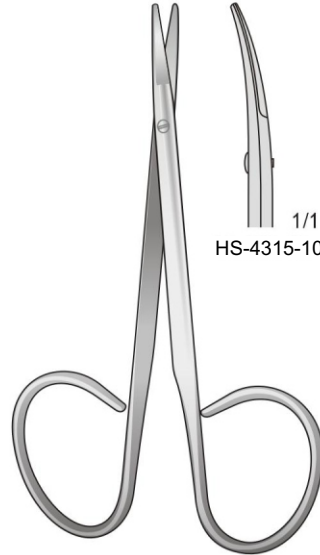
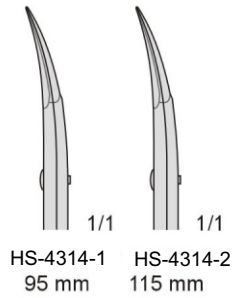

HS-4315  
100 mm

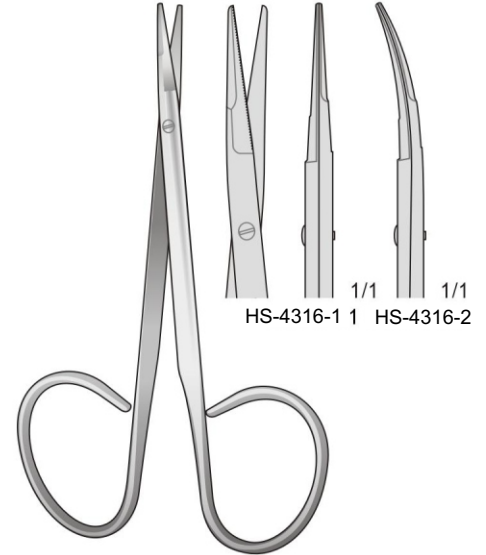
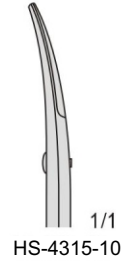

KAYE  
HS-4316  
105 mm

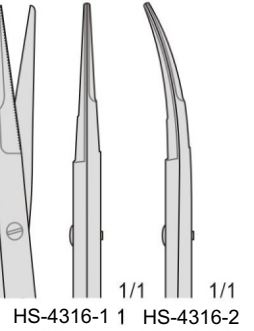

Stumpf - Blunt  
Smussa - Romas  
Mousse

Stumpf - Blunt  
Smussa - Romas  
Mousse

Spitz - Sharp  
Acuta - Aguda  
Pointu

Spitz - Sharp  
Acuta - Aguda  
Pointu

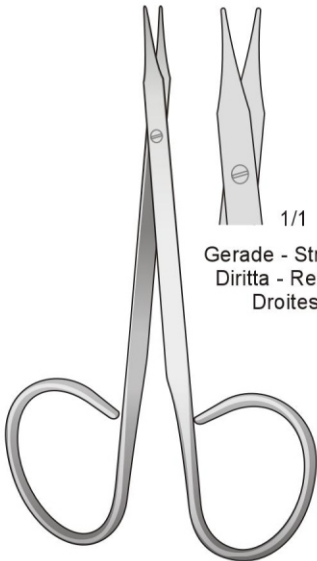

STEVENS  
HS-4317  
100 mm

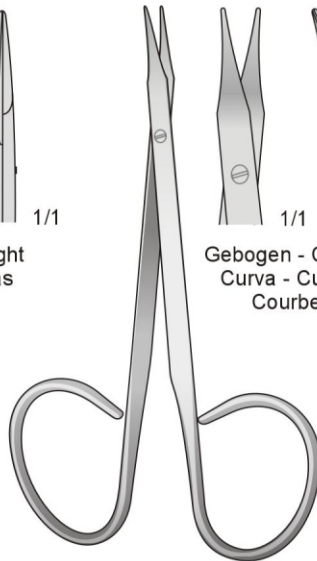
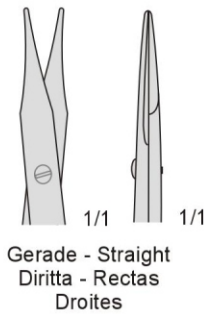

STEVENS  
HS-4318  
100 mm

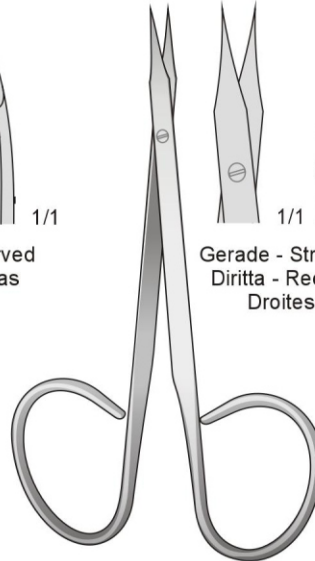
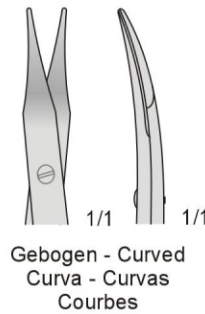

WALTON  
HS-4319  
100 mm

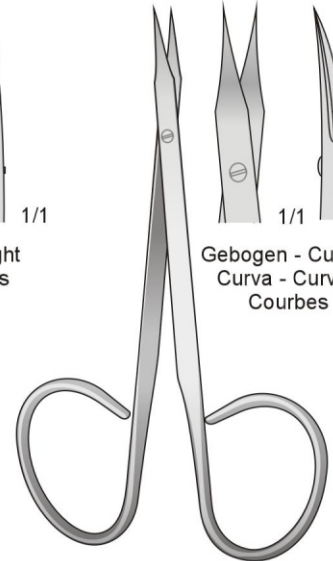
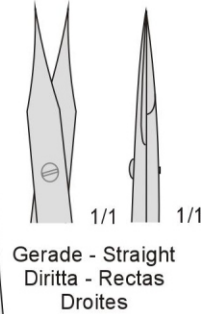

WALTON  
HS-4320  
100 mm

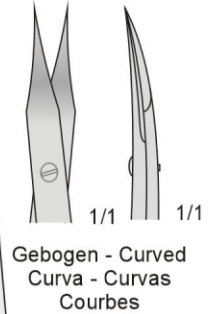

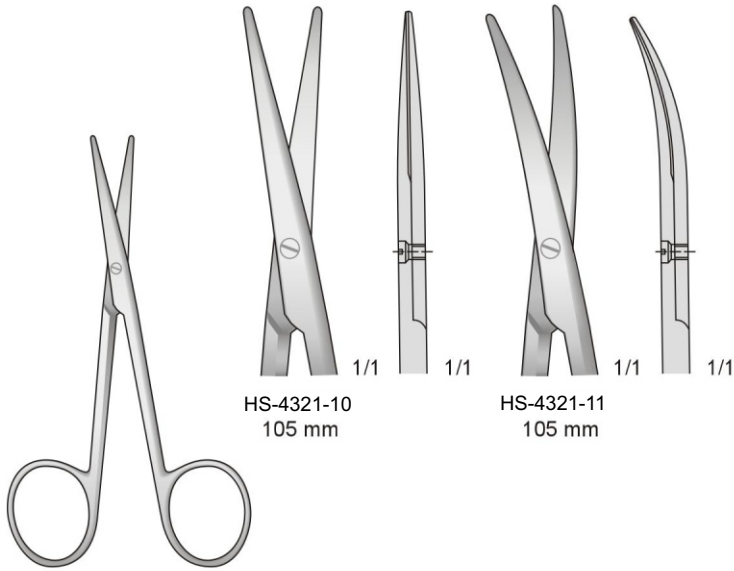

**COTTLE-KNAPP**  
HS-4321  
105 mm

**COTTLE**  
HS-4322  
115 mm

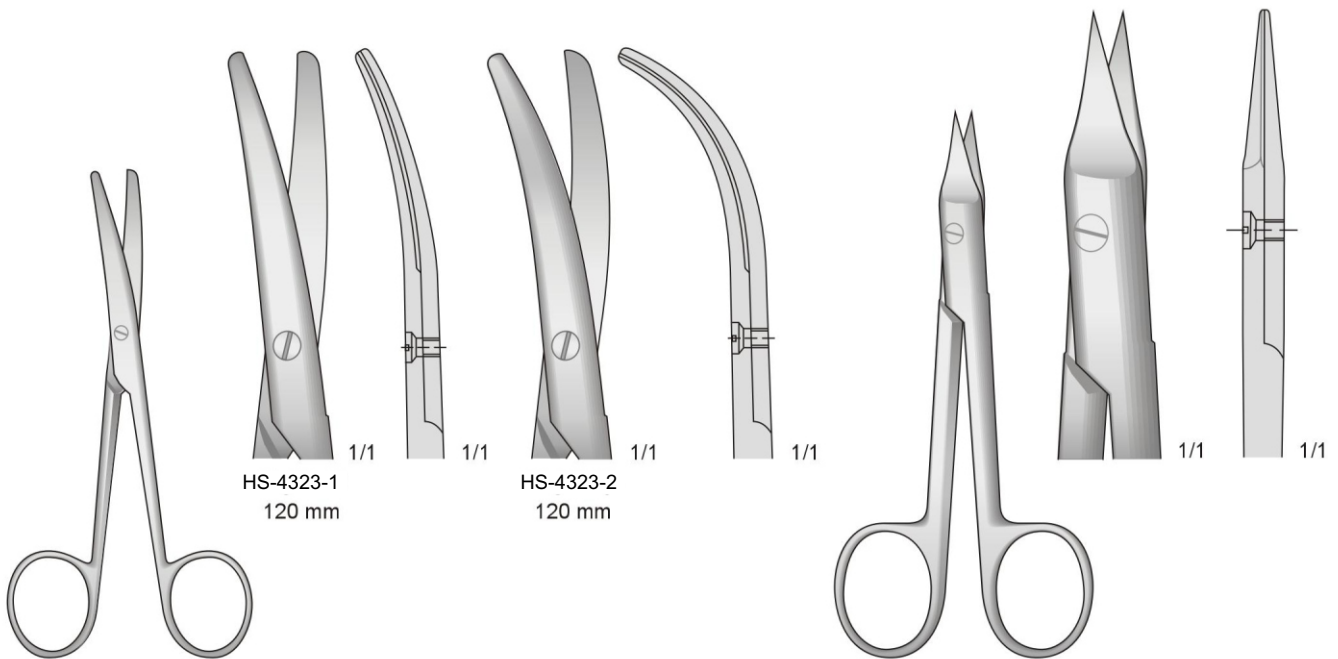

**LANDOLT**  
HS-4323  
120 mm

**SYSTRUNK**  
HS-4324  
130 mm

Spitz  
 Sharp  
 Acuta  
 Aguda  
 Pointu



O'BRIEN  
 HS-4325  
 95 mm

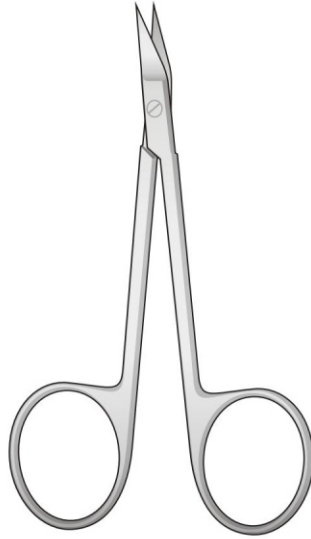

DANIELS  
 HS-4326  
 90 mm

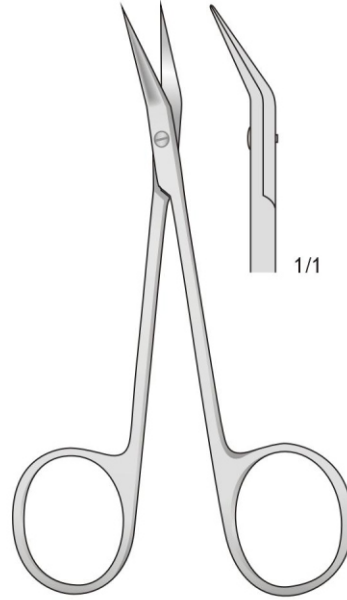

BIRO  
 HS-4327  
 100 mm

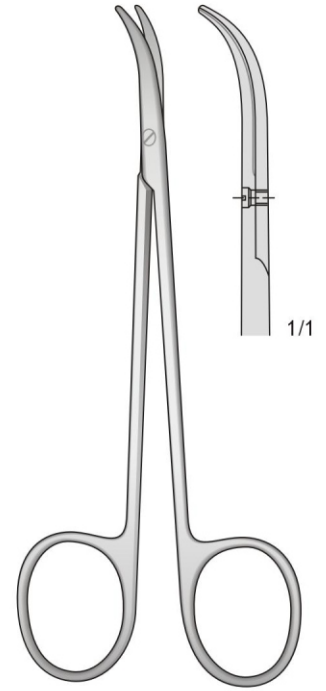

CINELLI  
 HS-4328  
 115 mm

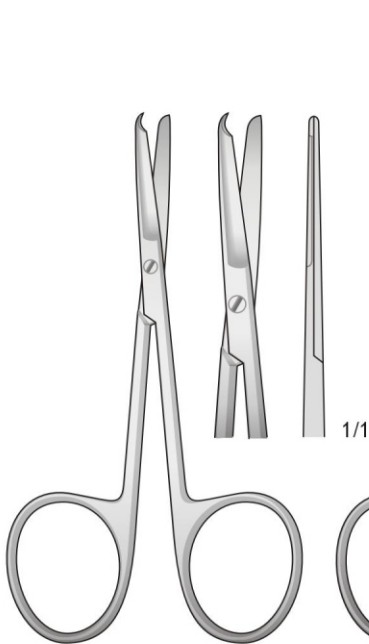

SPENCER  
 HS-4329  
 90 mm

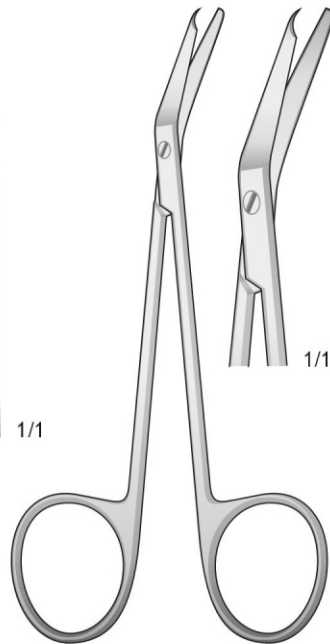

SPENCER  
 HS-4330  
 130 mm

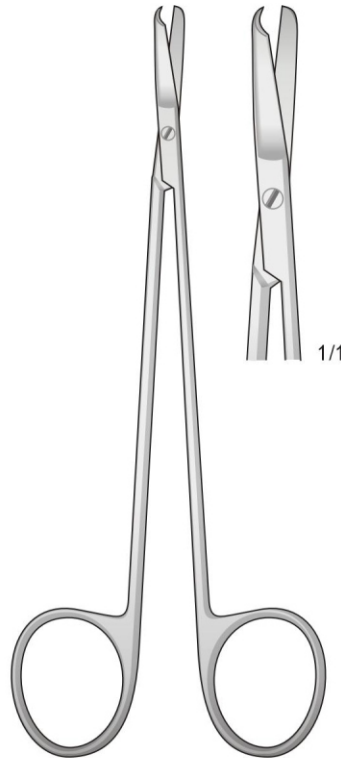

KELLY  
 HS-4331  
 150 mm

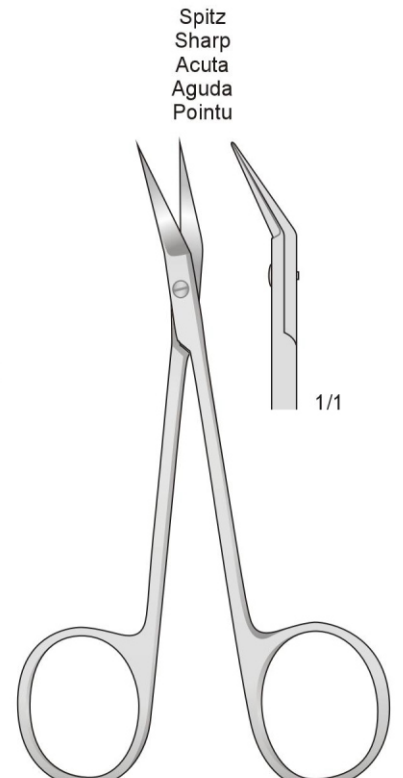

WILMER  
 HS-4332  
 105 mm

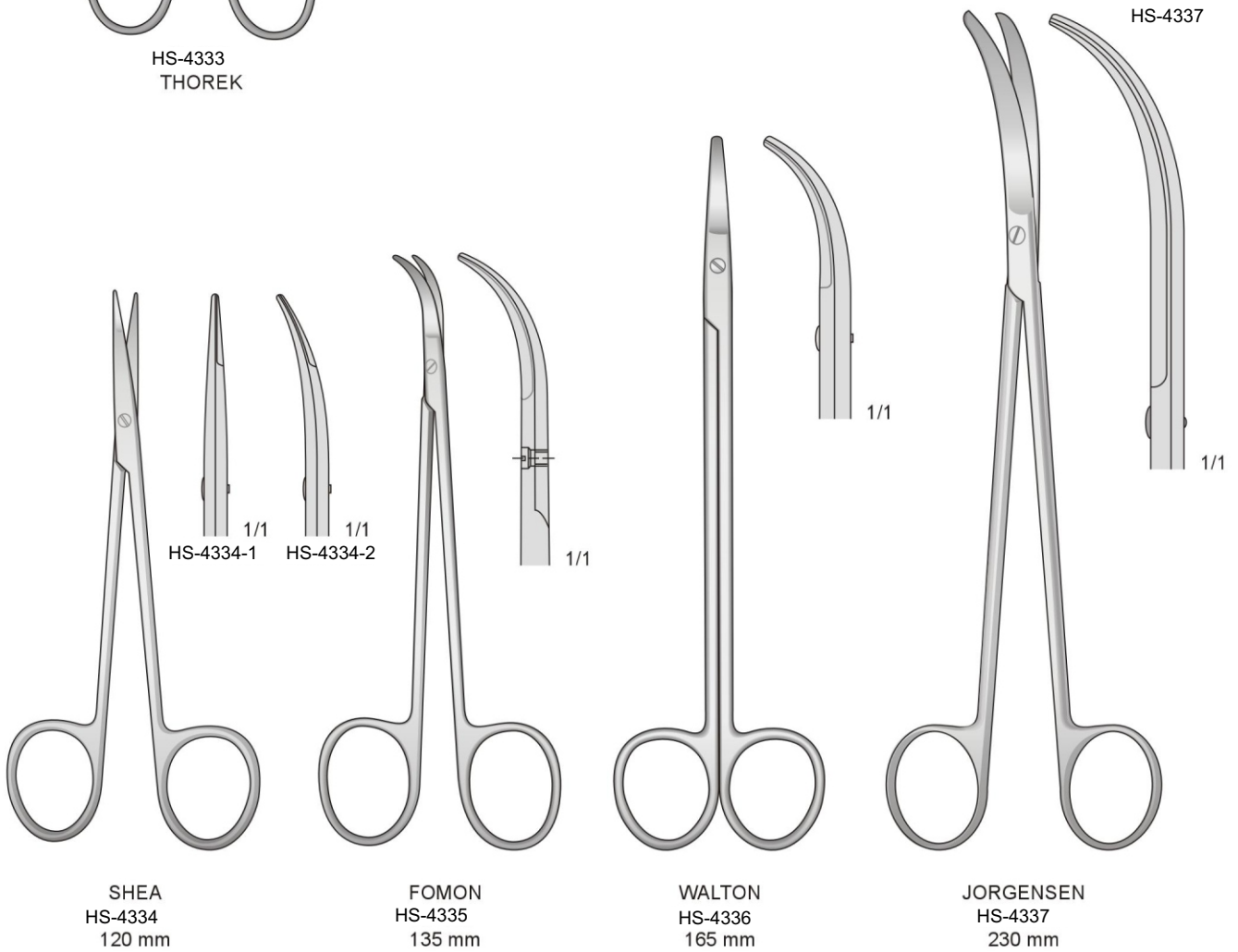



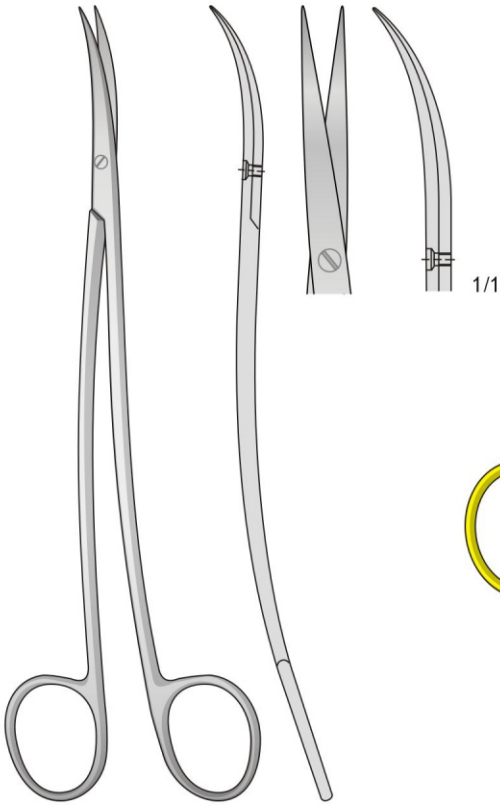

**METZENBAUM-FINO**  
HS-4338-1 - 180 mm  
HS-4339-2 - 200 mm  
HS-4340-3 - 230 mm

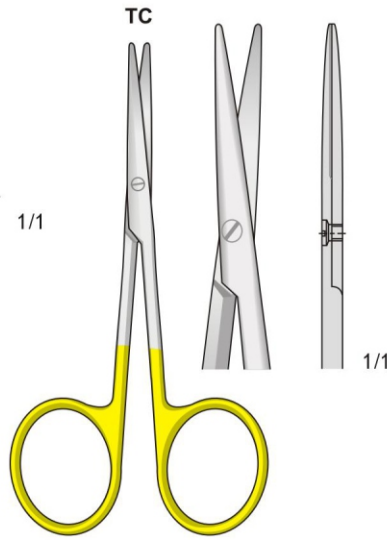

**LEXER-BABY**  
HS-4341  
100 mm

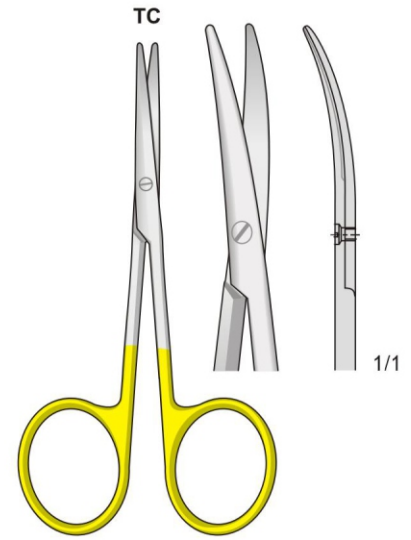

**LEXER-BABY**  
HS-4342  
100 mm

Gezahnt - Sawedge  
Dentellate - Dentadas  
Dentelés

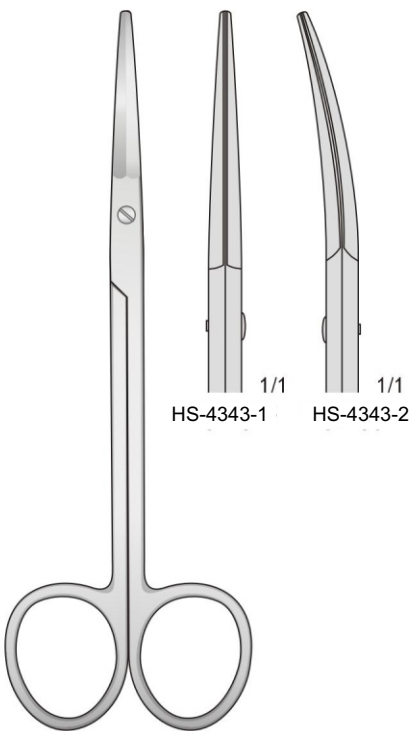

**KAHN**  
HS-4343  
145 mm

Gezahnt - Sawedge  
Dentellate - Dentadas  
Dentelés

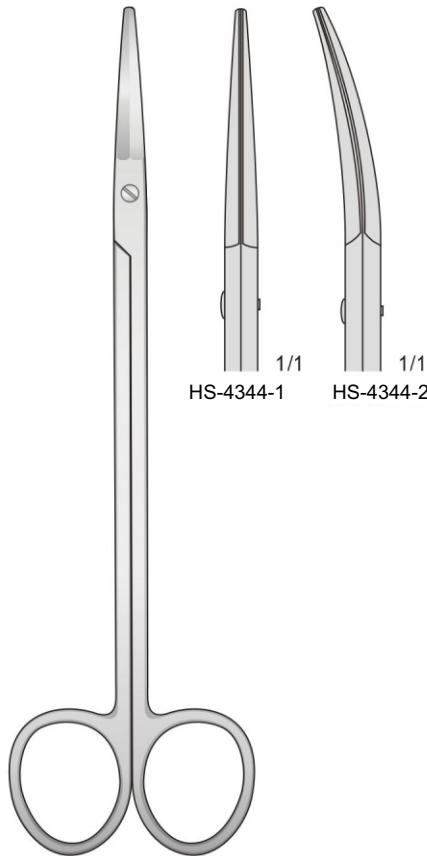

**KAHN**  
HS-4344  
180 mm

Gezahnt - Sawedge  
Dentellate - Dentadas  
Dentelés

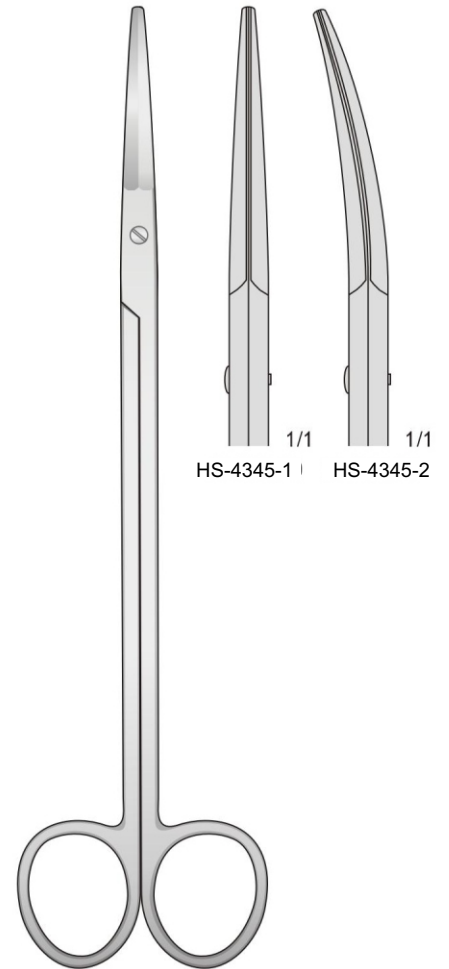

**KAHN**  
HS-4345  
205 mm

Eine Schneide gezahnt S-förmig gebogen  
One toothed cutting edge S-shaped  
Una lama dentata curva a forma S  
Una hoja dentada forma S  
Une lame dentelée courbés en S

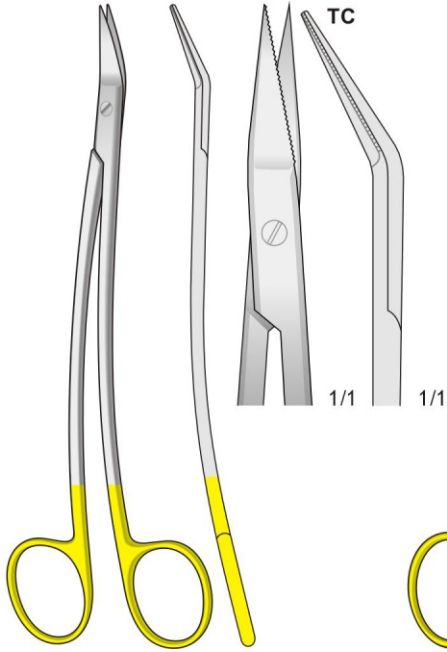

HS-4346  
175 mm

TC

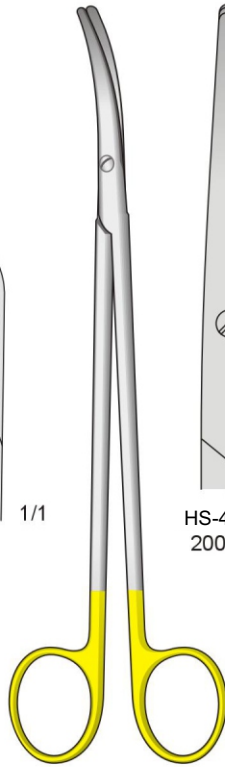

METZENBAUM-THOREK  
HS-4347

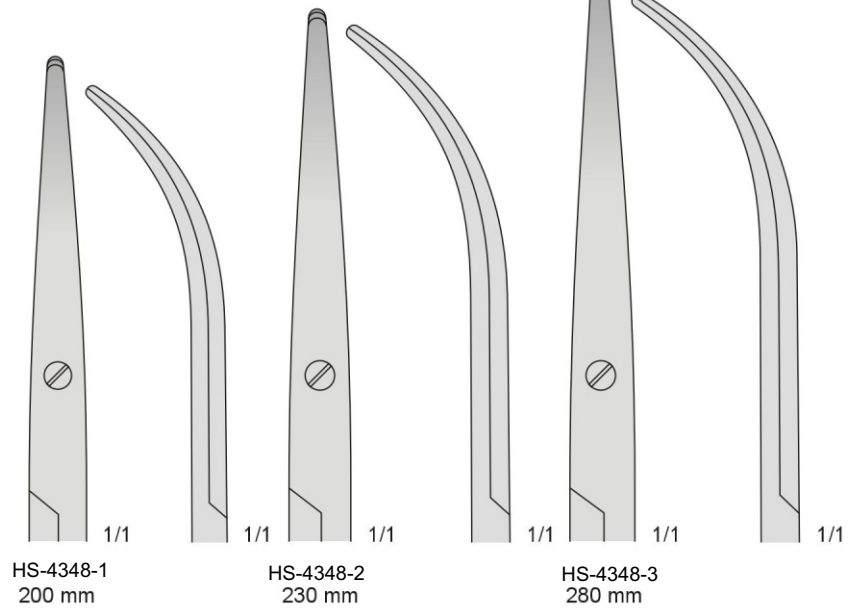

HS-4348-1  
200 mm

HS-4348-2  
230 mm

HS-4348-3  
280 mm

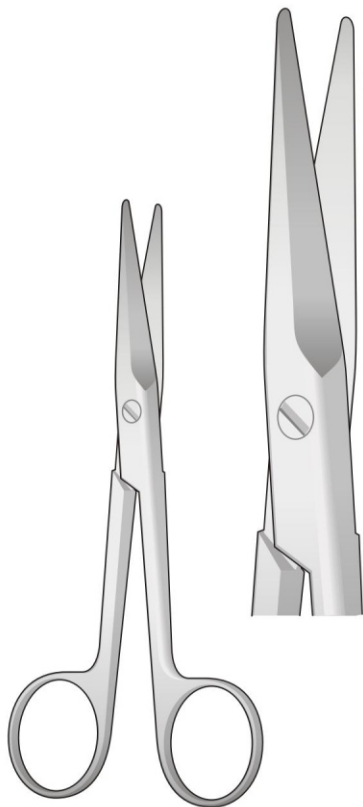

MAYO  
HS-4349  
155 mm

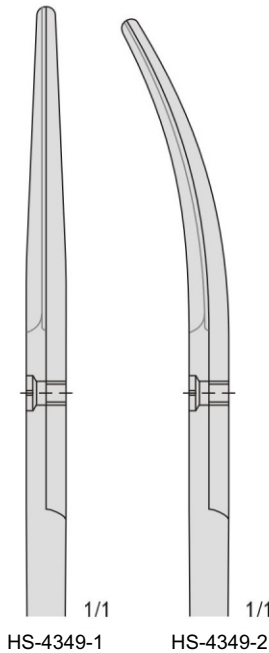

HS-4349-1

HS-4349-2

TC

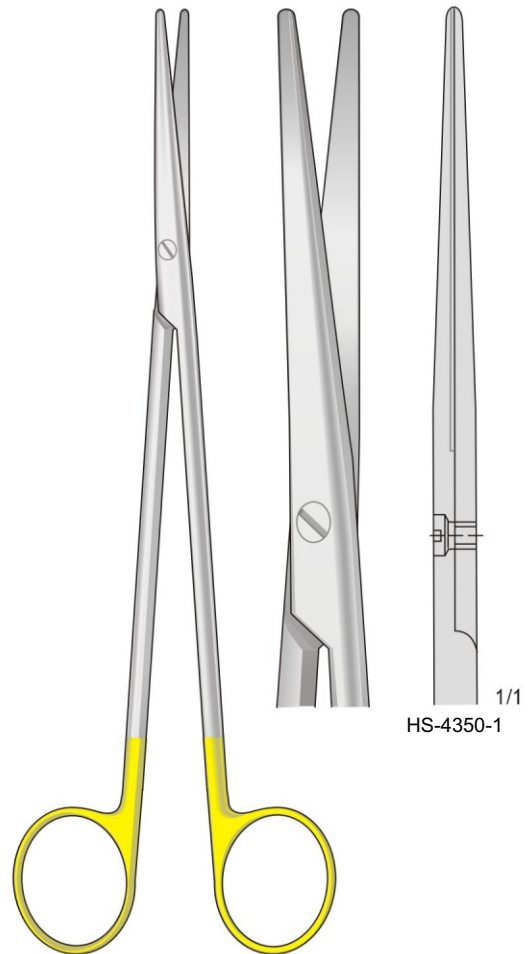

METZENBAUM  
HS-4350  
280 mm

HS-4350-1

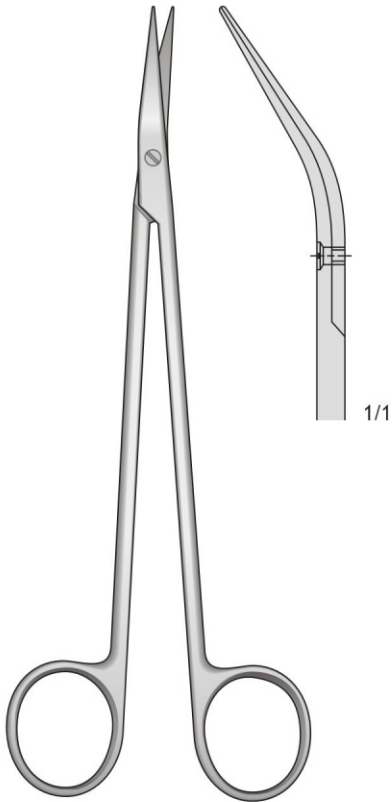

POTTS-SMITH  
HS-4352  
175 mm

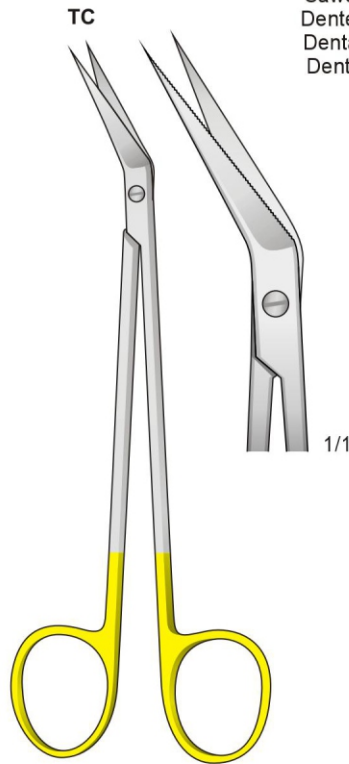

HS-4353  
160 mm

Gezahnt  
Sawedge  
Dentellate  
Dentadas  
Dentelés

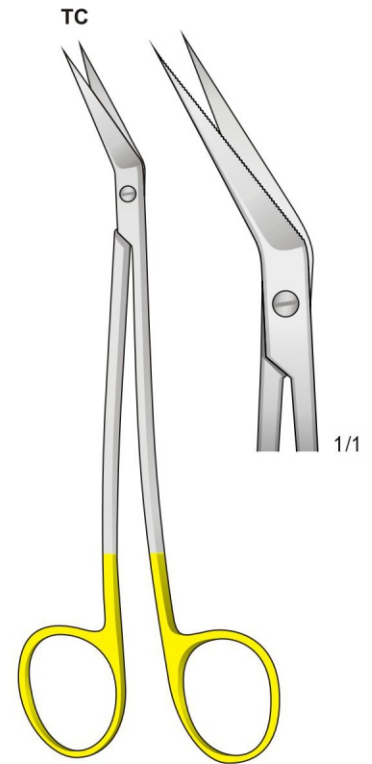

HS-4354  
160 mm

Gefäßscheren  
Vessel scissors

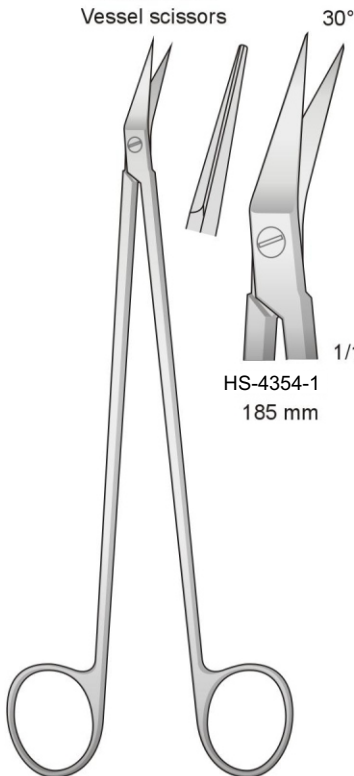

POTTS-DE MARTEL  
HS-4354  
185 mm

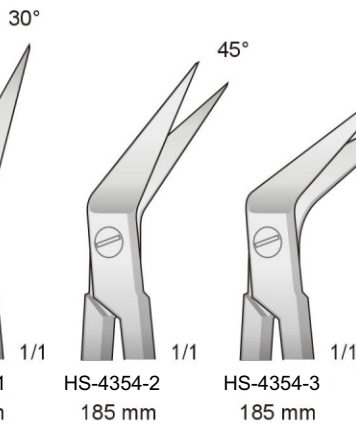

HS-4354-1  
185 mm

HS-4354-2  
185 mm

HS-4354-3  
185 mm

Coronararterien-Schere  
Coronary artery scissors

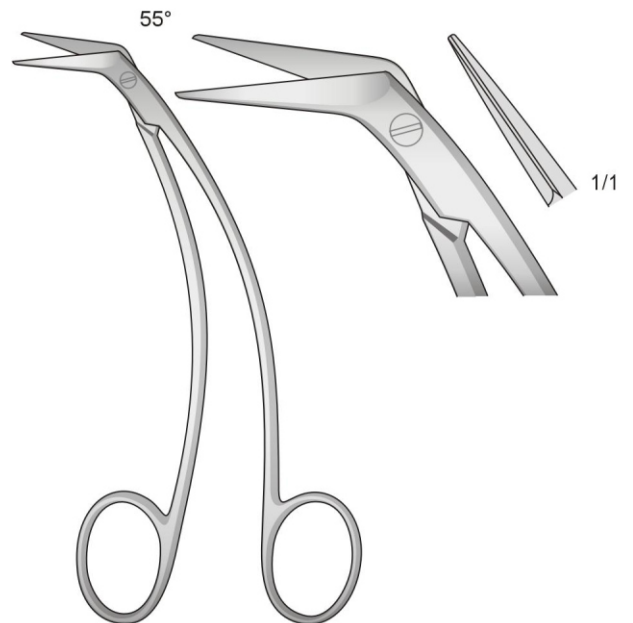

FAVOLORO  
HS-4355  
140 mm

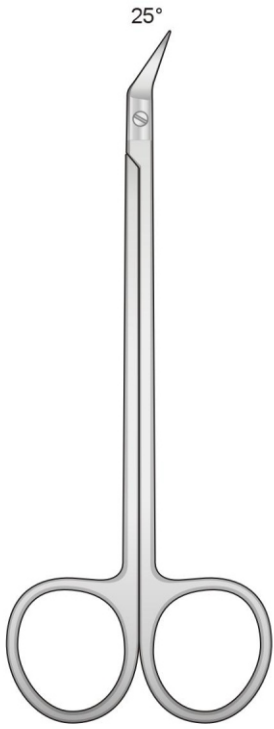

HS-4356  
135 mm

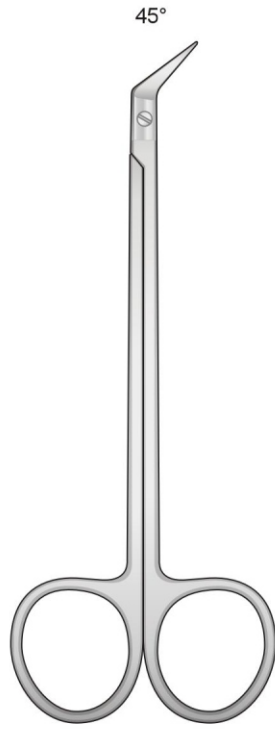

HS-4357  
135 mm

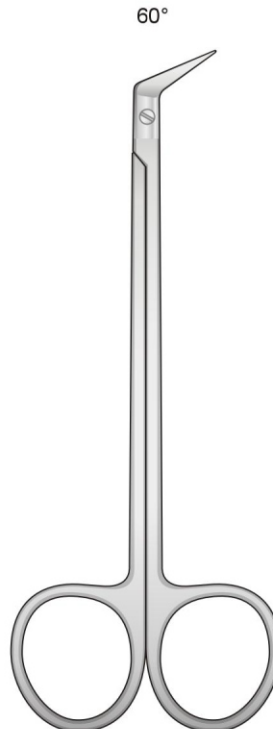

HS-4358  
135 mm

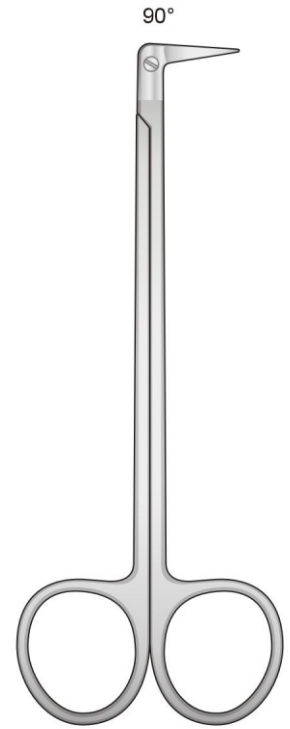

HS-4359  
135 mm

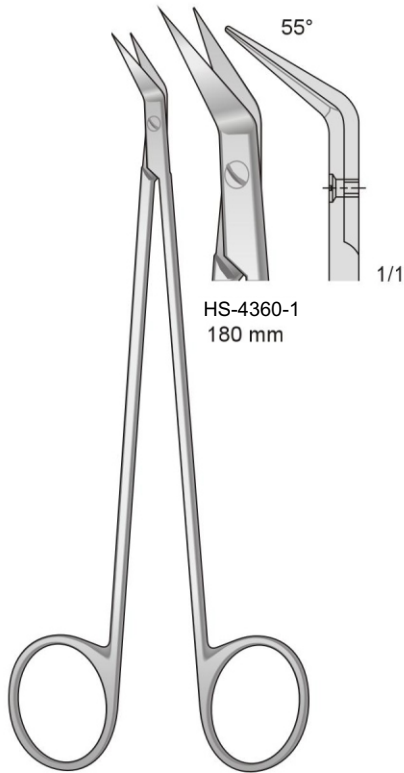

HS-4360-1  
180 mm

POTTS-SMITH  
HS-4360  
180 mm

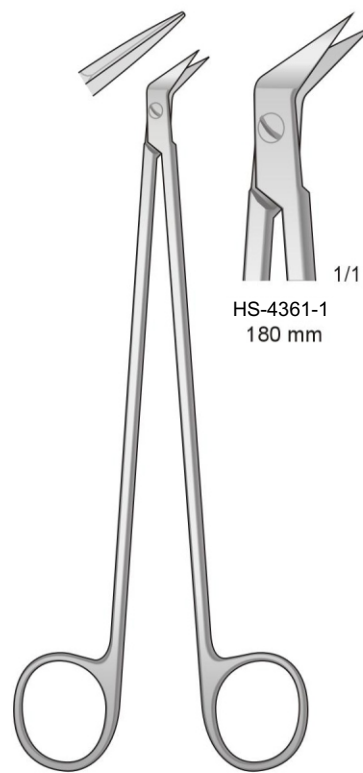

HS-4361-1  
180 mm

POTTS-SMITH  
HS-4361  
180 mm



**Operating Scissors**

Gezahnt - Serrated  
Dentellata - Dentadas  
Dentelés

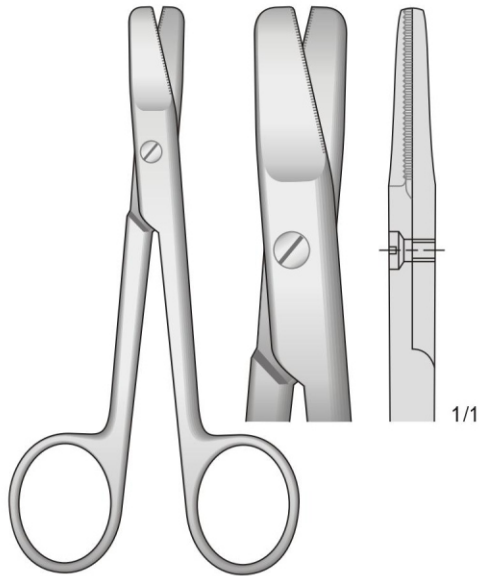

HARVEY  
HS-4362  
125 mm

Spitz - Sharp  
Acuta - Agudo - Aigu



METZENBAUM  
HS-4363  
145 mm

Kapselschere  
Forbice da cartilagine  
Cartilage Scissors

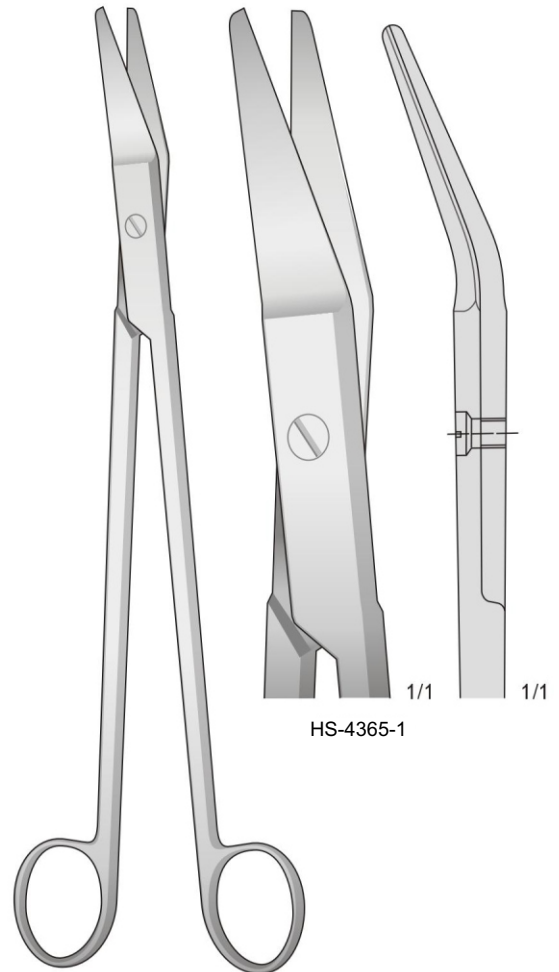

RESANO  
HS-4365  
250 mm

Uterusschere  
Uterine scissors



BOZEMANN  
HS-4364  
220 mm



Gezahn - Serrated  
Dentellata - Dentadas - Dentées

TC

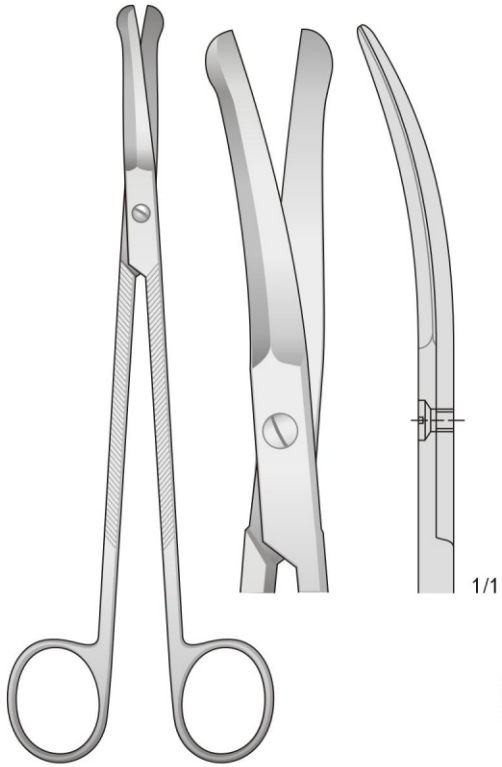

GOOD  
HS-4366  
195 mm

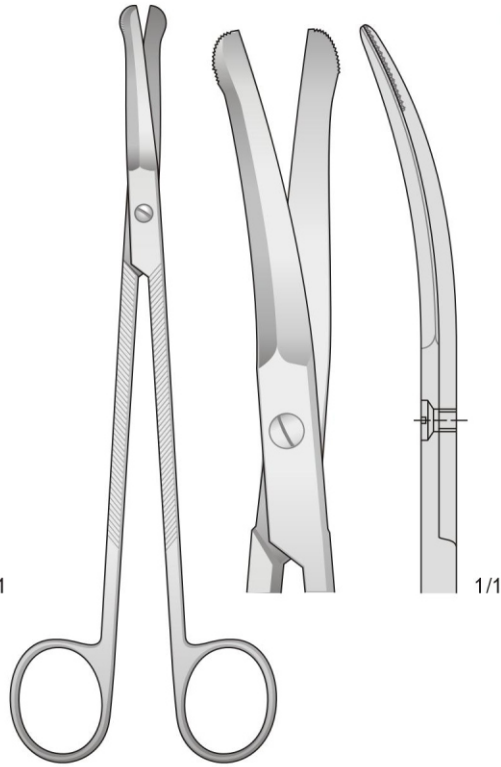

SCHWECKENDIEK  
HS-4367  
195 mm

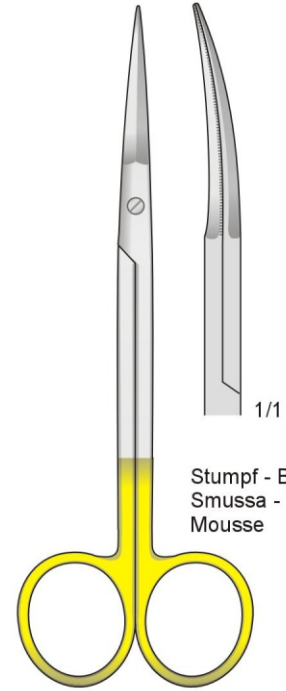

PECK-JOSEPH  
HS-4368  
140 mm

Stumpf - Blunt  
Smussa - Romas  
Mousse

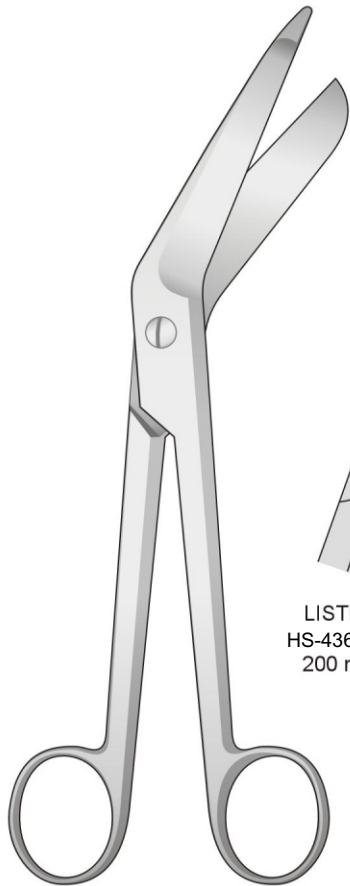

LISTER  
HS-4369-1  
200 mm

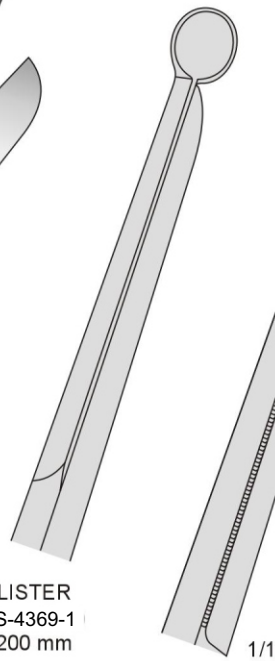

BERGMANN  
HS-4369-2  
230 mm

TC

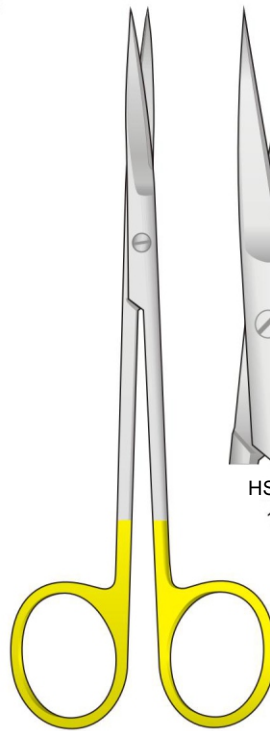

JOSEPH  
HS-4370  
150 mm

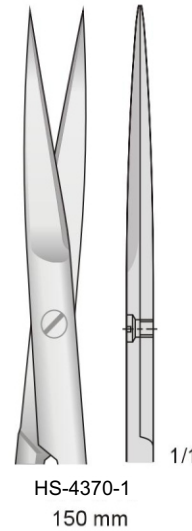

HS-4370-1  
150 mm

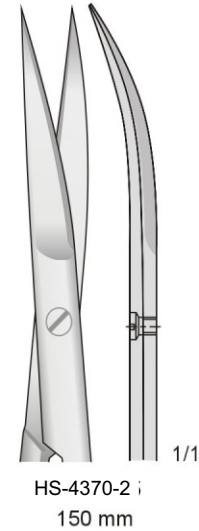

HS-4370-2  
150 mm

**Operating Scissors**

“Super-cut” scheren micro-schliff für tissue atrauma  
 “Super-cut” scissors for gripping tissue and cutting interproximally  
 Forbici “super-cut” estremamente taglienti per tessuti con riduzione del trauma  
 Tijeras “super cortes” para cortar tissue-atrauma  
 Ciseaux “super cut” coupe les tissus en reduisant les risques de traumatisme

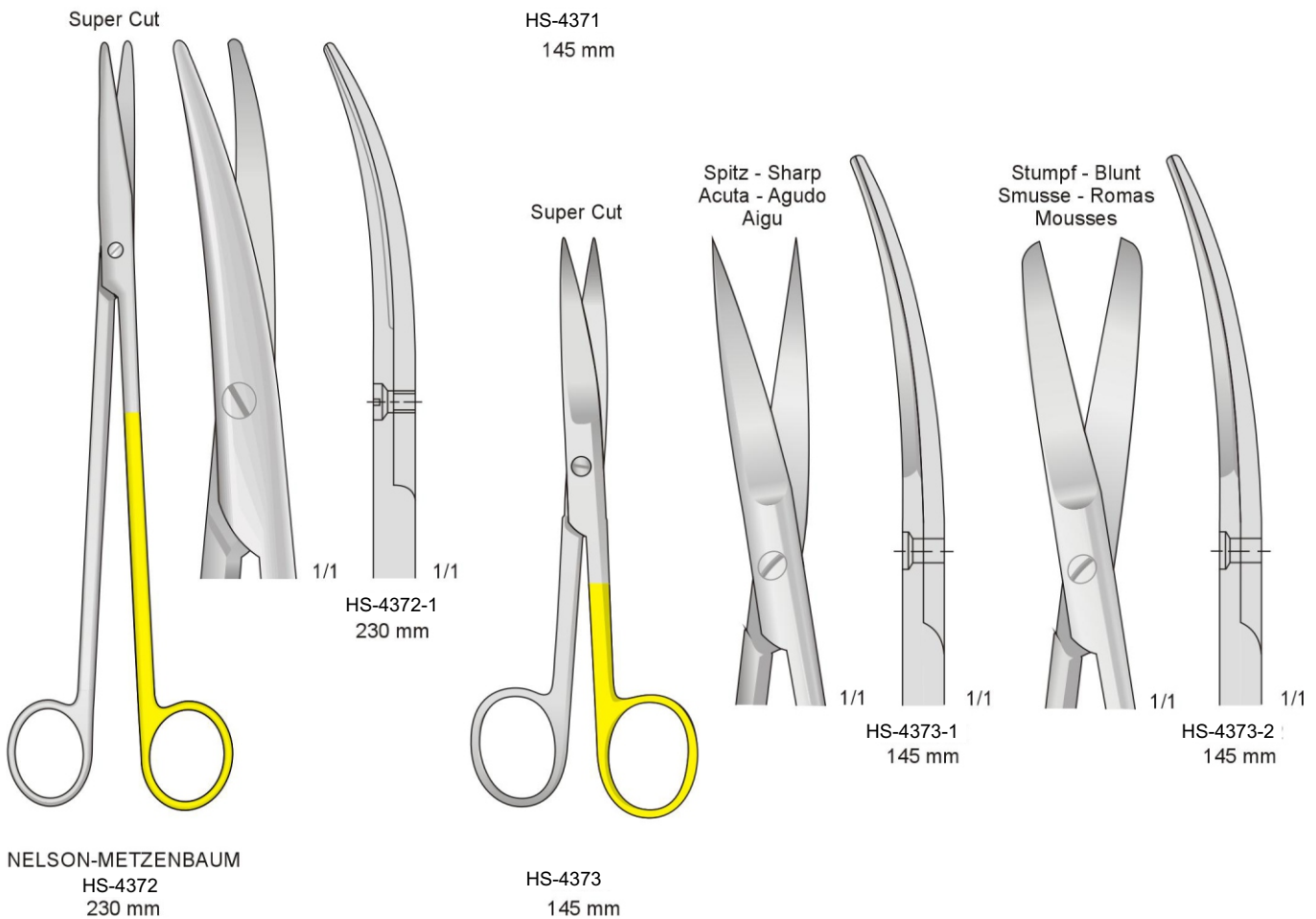
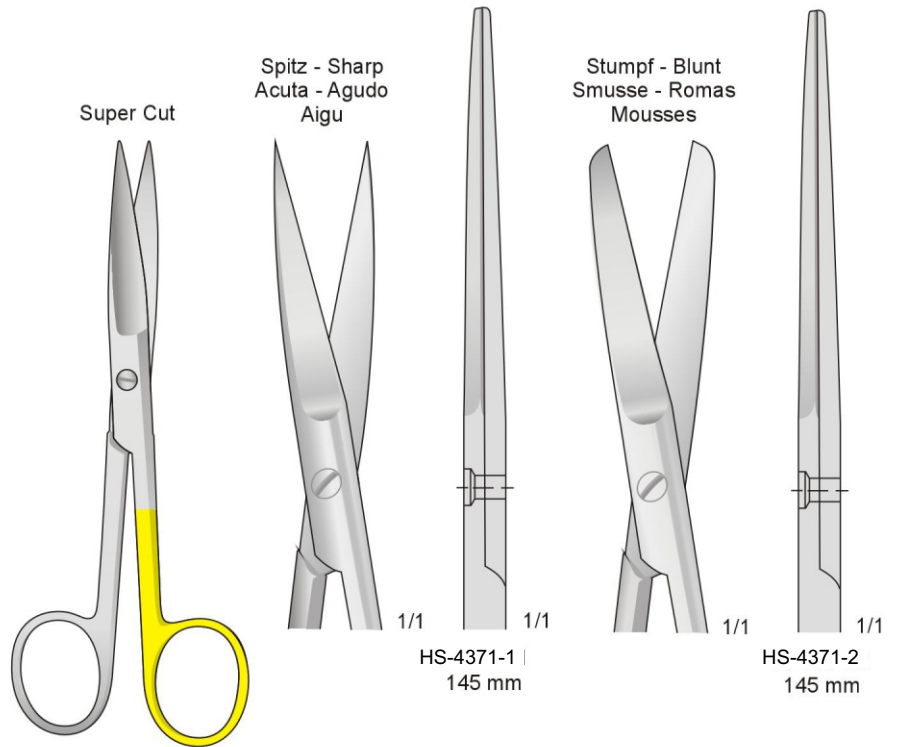

Mit Hartmetalleinsätzen  
Tungsten-carbide scissors  
Con punta al carburo di tungsteno  
Tijeras de tungsteno  
Avec plaquettes en carbure de tungstène

Mit eine Schneide gezahnt  
With one blade serrated  
Con una lama zigrinata  
Con una hoja dentada  
Avec lame dentèle

Super Cut  
TC

Mit eine Schneide gezahnt  
With one blade serrated  
Con una lama zigrinata  
Con una hoja dentada  
Avec lame dentèle

Super Cut  
TC

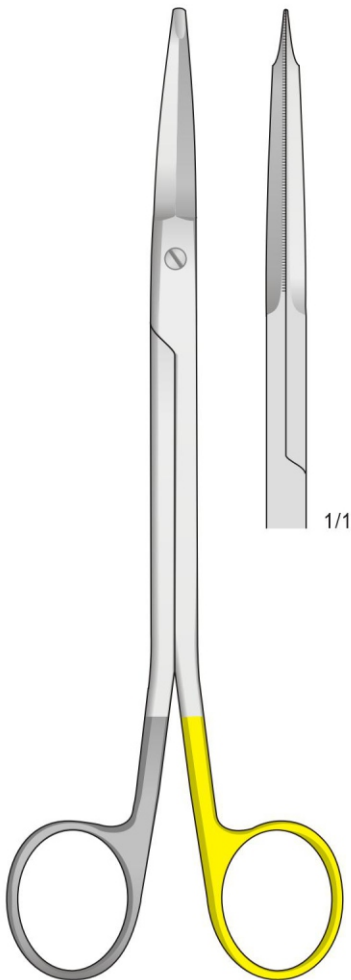

FREEMAN GORNEY  
HS-4374  
180 mm

Mit eine Schneide gezahnt  
With one blade serrated  
Con una lama zigrinata  
Con una hoja dentada  
Avec lame dentèle

Super Cut  
TC

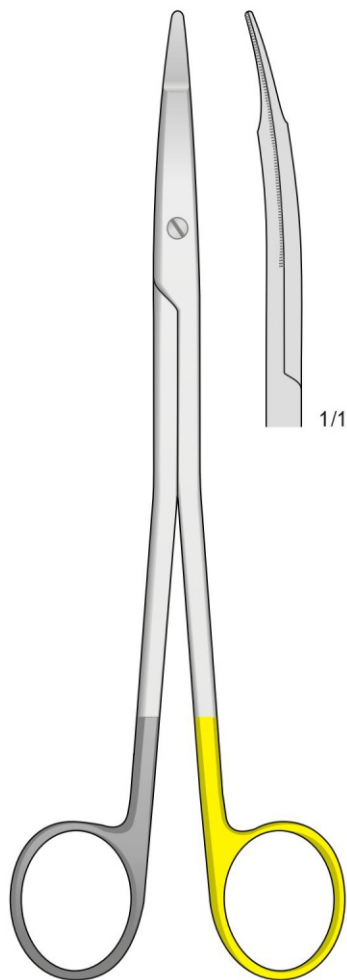

FREEMAN  
HS-4375  
180 mm

Mit eine Schneide gezahnt  
With one blade serrated  
Con una lama zigrinata  
Con una hoja dentada  
Avec lame dentèle

Super Cut  
TC

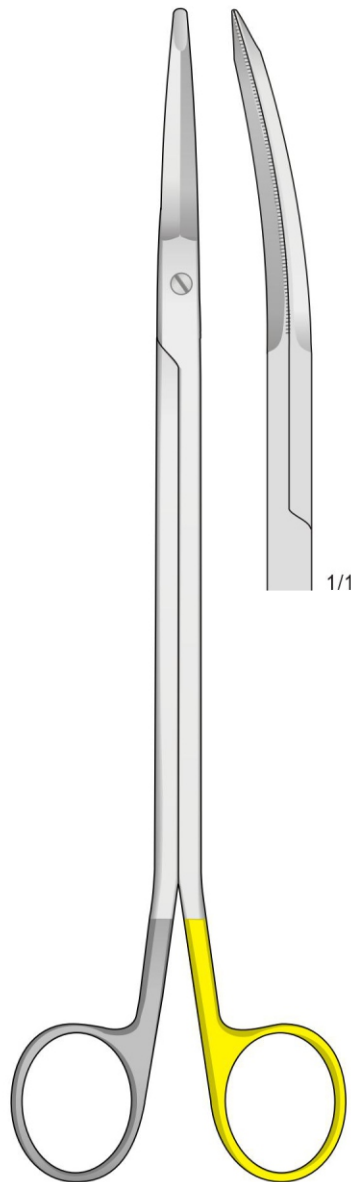

GORNEY  
HS-4376  
230 mm

Mit eine Schneide gezahnt  
With one blade serrated  
Con una lama zigrinata  
Con una hoja dentada  
Avec lame dentèle

Super Cut

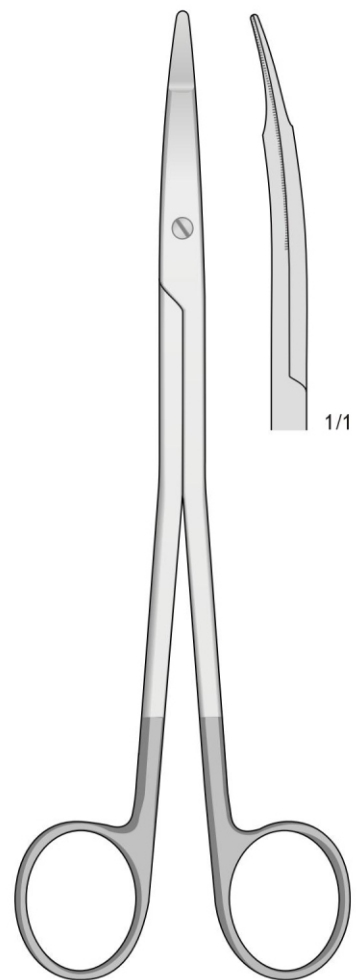

FREEMAN  
HS-4377  
180 mm

Mit Hartmetalleinsätzen  
 Tungsten-carbide scissors  
 Con punta al carburo di tungsteno  
 Tijeras de tungsteno  
 Avec plaquettes en carbure de tungstène

Mit eine Schneide gezahnt  
 With one blade serrated  
 Con una lama zigrinata  
 Con una hoja dentada  
 Avec lame dentèle

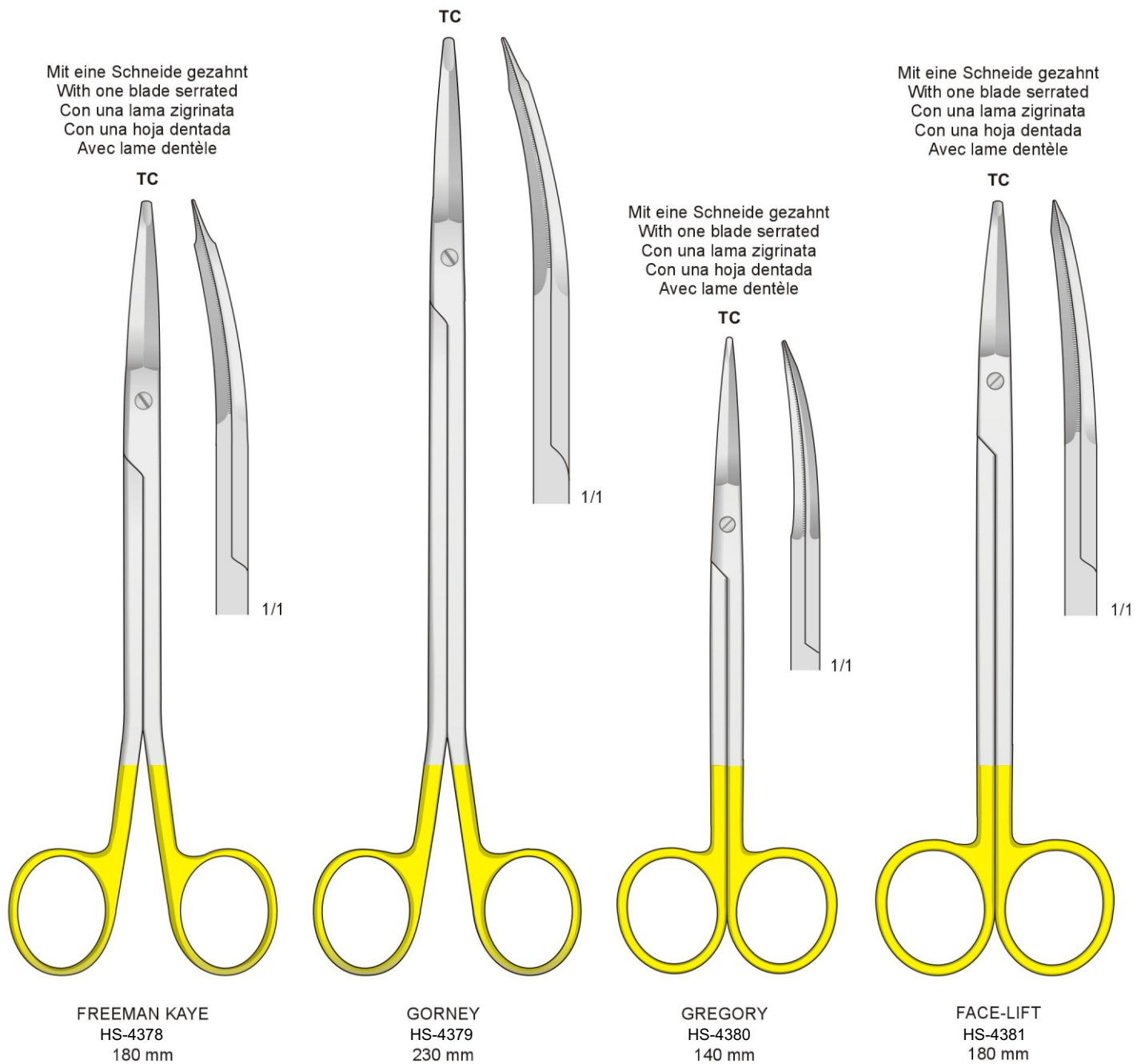

*Tissue Forceps*

Pinzette mit Häkchen  
Suturing Forceps  
Pinzette per suture

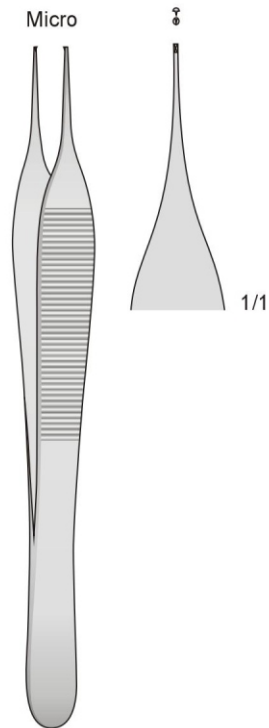

ADSON  
HS-4382  
150 mm

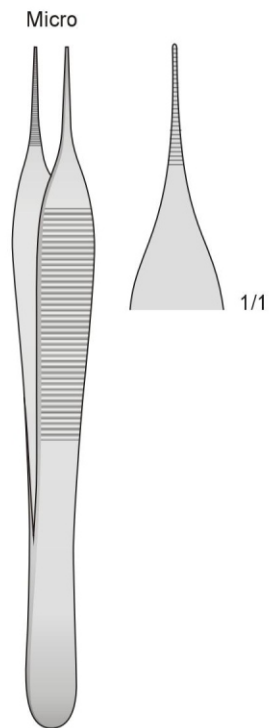

ADSON  
HS-4383  
150 mm



ADSON  
HS-4384  
125 mm

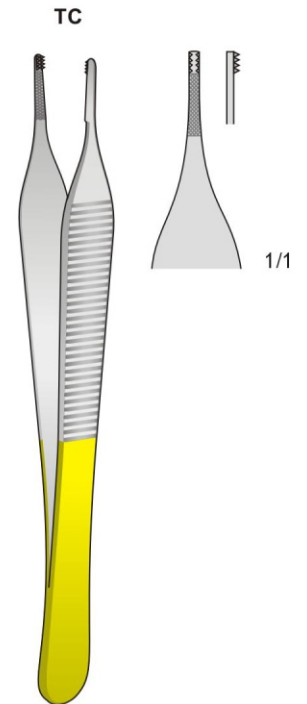

ADSON-BROWN  
HS-4385  
120 mm

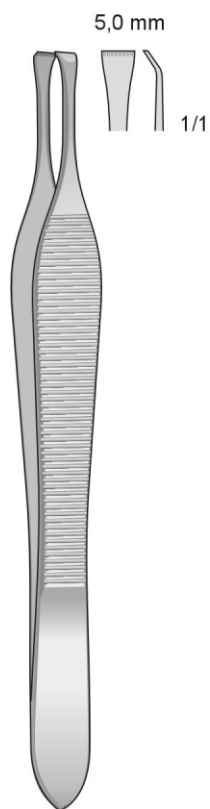

BEASLEY-BABCOCK  
HS-4386  
120 mm

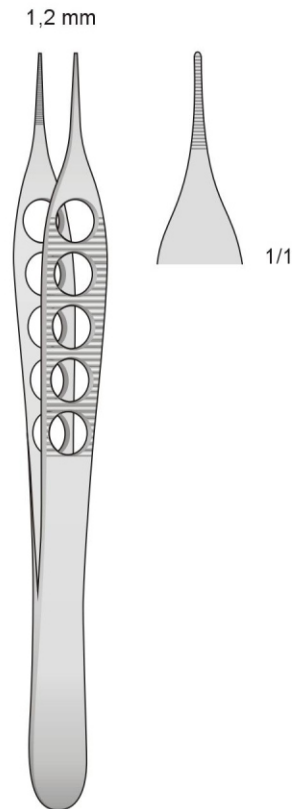

ADSON  
HS-4387  
120 mm

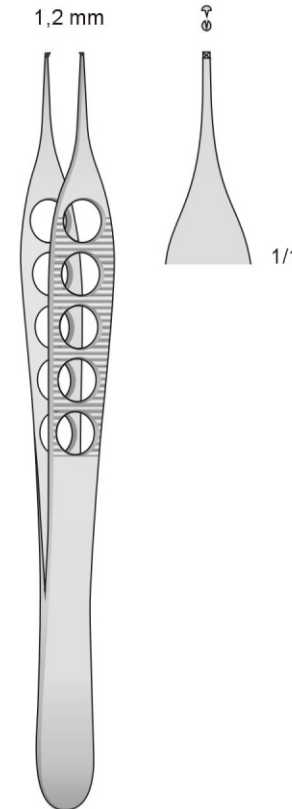

ADSON  
HS-4388  
120 mm

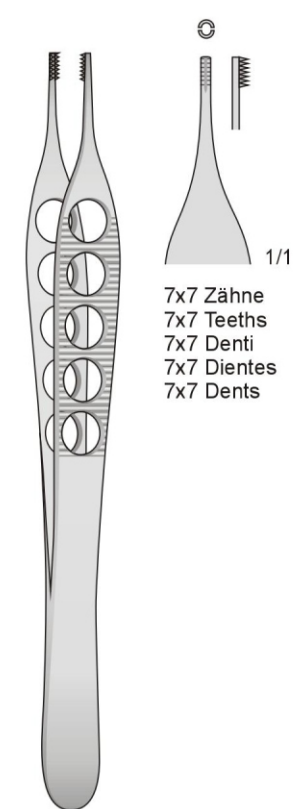

ADSON-BROWN  
HS-4389  
120 mm

7x7 Zähne  
7x7 Teeths  
7x7 Denti  
7x7 Dientes  
7x7 Dents



**Mikroprofil - Micro profile**  
**Profilo micro - Perfil micro - Profil micro**  
 2.0 mm

**TC**

HS-4390-1 160 mm    HS-4390-2 200 mm    HS-4390-3 245 mm

**TC**

HS-4391-1 175 mm    HS-4391-2 175 mm

1x2 Zähne  
1x2 Teeth  
1x2 Denti  
1x2 Dientes

**BONNEY**  
HS-4392 180 mm

1x2 Zähne  
1x2 Teeth  
1x2 Denti  
1x2 Dientes

**McINDOE**  
HS-4393 150 mm

HS-4393-1 150 mm    HS-4393-2 150 mm

**GILLIES**  
HS-4394 150 mm

HS-4394-1 150 mm    HS-4394-2 150 mm

**LANE**  
HS-4395

HS-4395-1 150 mm    HS-4395-2 150 mm    HS-4395-3 175 mm

1x2 Zähne  
1x2 Teeth  
1x2 Denti  
1x2 Dientes

2x3 Zähne  
2x3 Teeth  
2x3 Denti  
2x3 Dientes

1x2 Zähne  
1x2 Teeth  
1x2 Denti  
1x2 Dientes

*Tissue Forceps*

Titan - Titanium - Titano - Titane

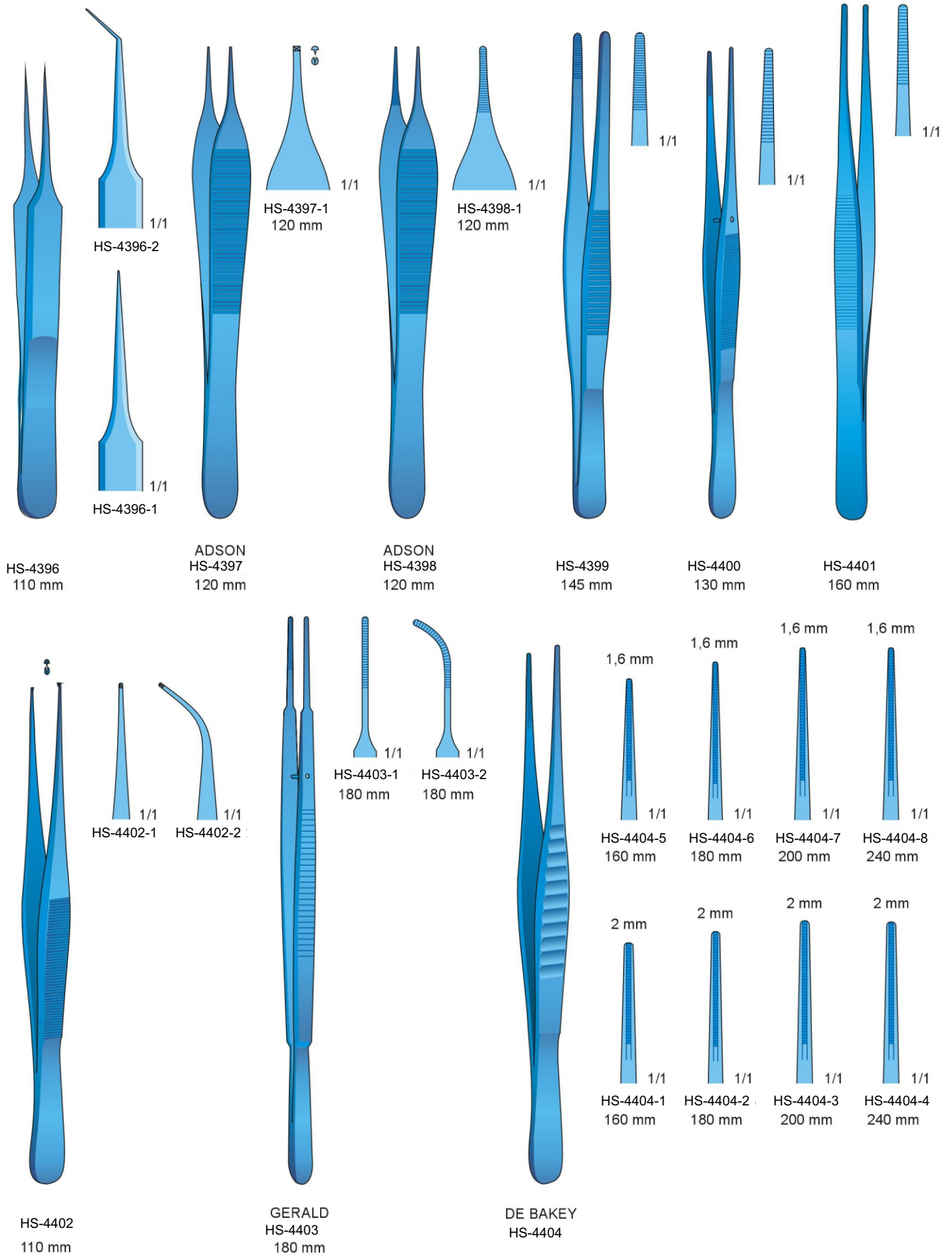

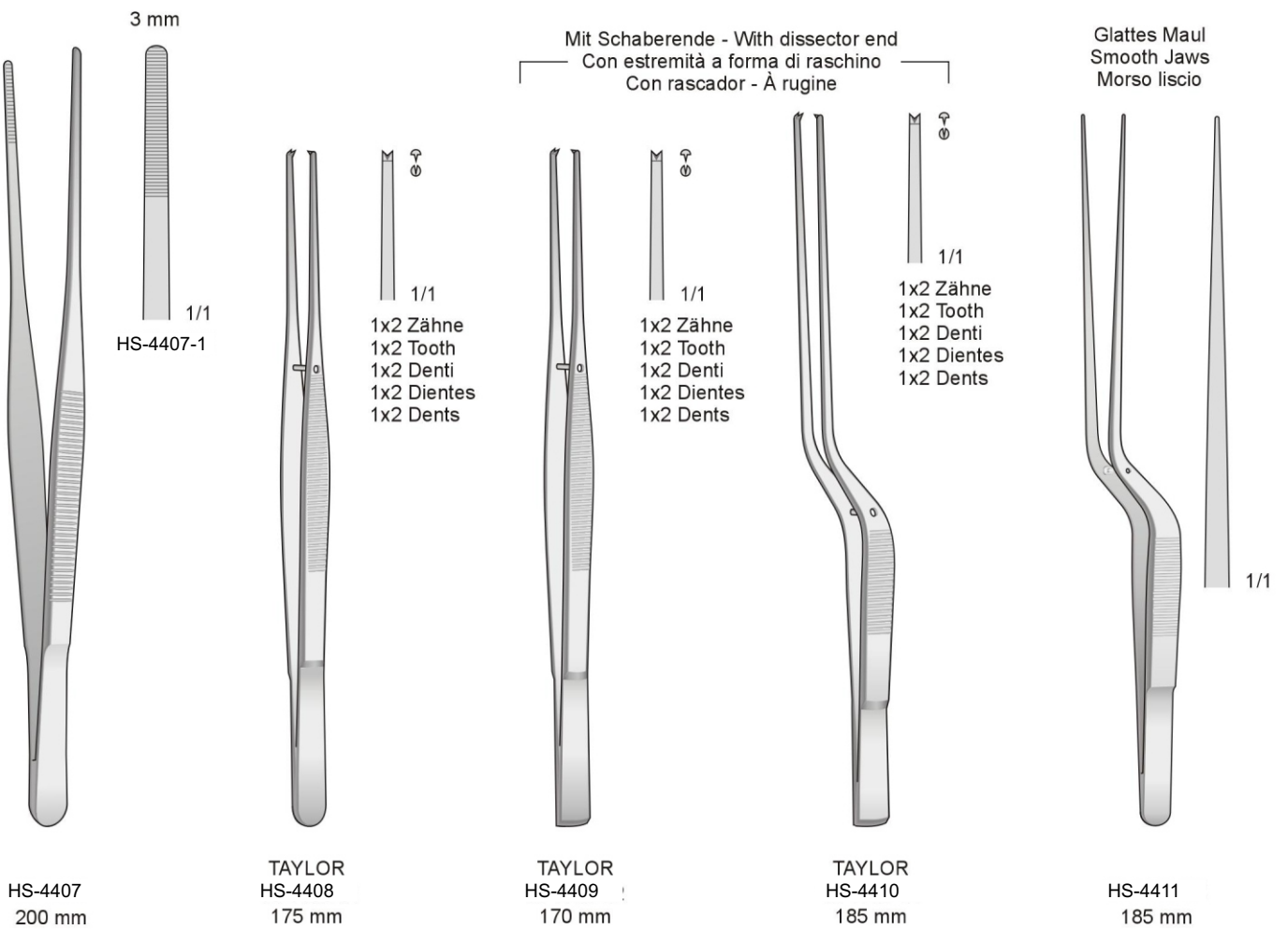
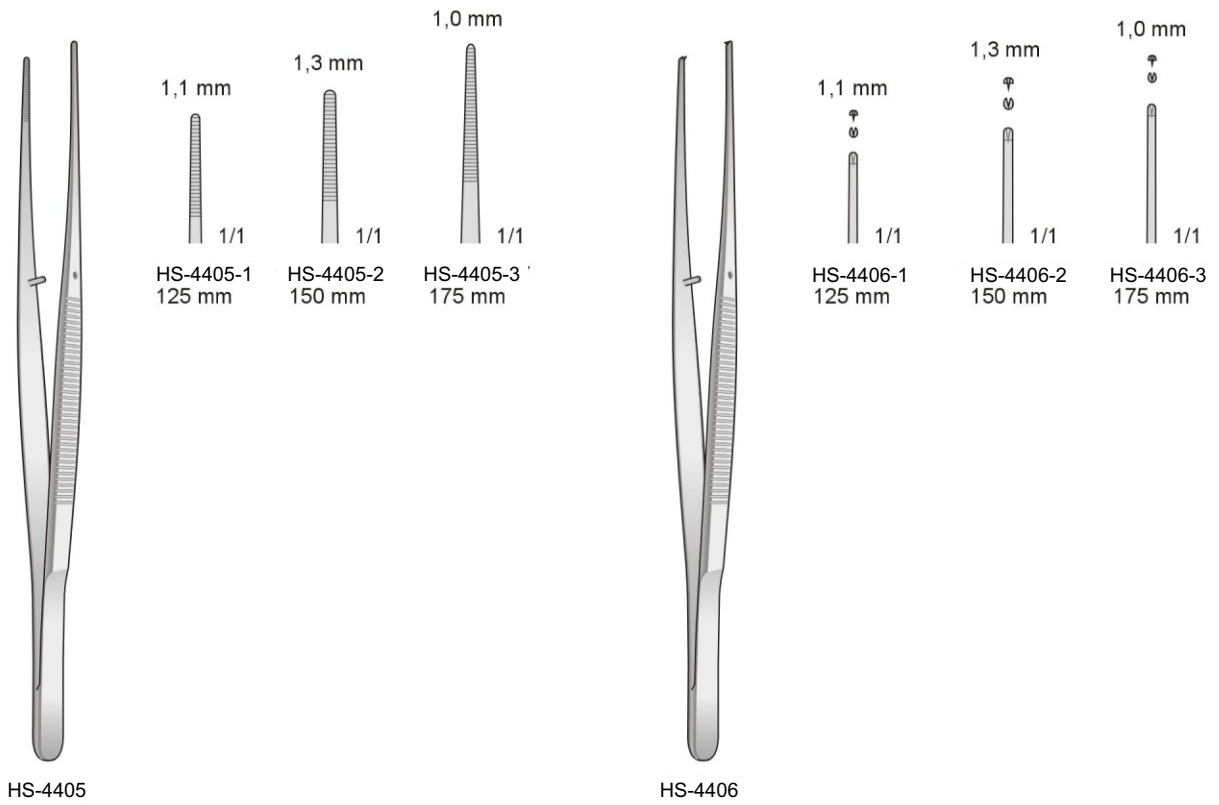

**Tissue Forceps**

Isoliert - Insulated - Isolate - Aislante - Isolant  
Monopolar - Monopolari

new

mit sterilisierfähiger Kunststoff-Isolierbeschichtung - with autoclavable plastic coated insulated handles  
con rivestimento isolante in plastica sterilizzabile - con recubrimiento aislante de materia plástica esterilizable  
à enduit plastique isolant, stérilisable

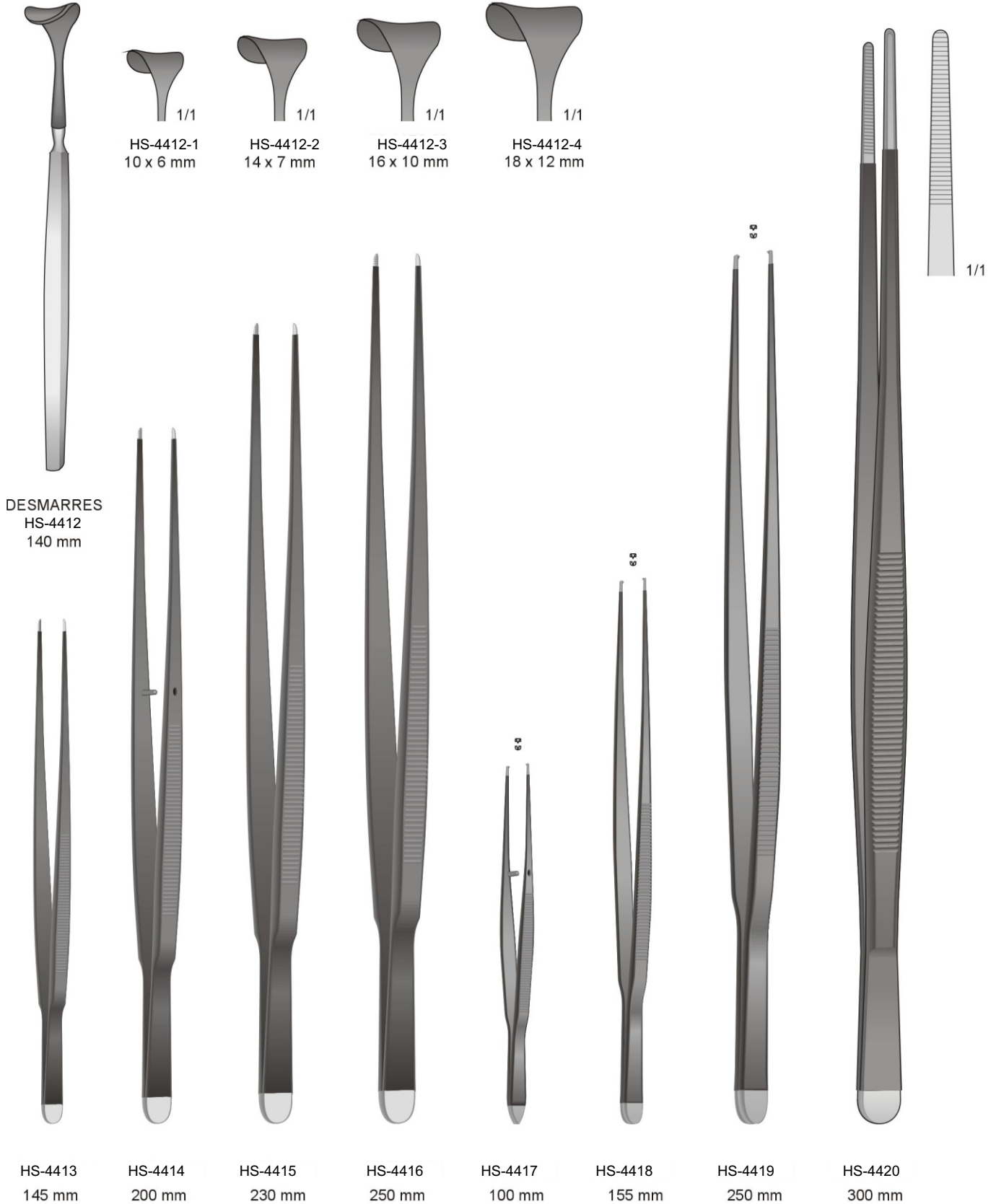

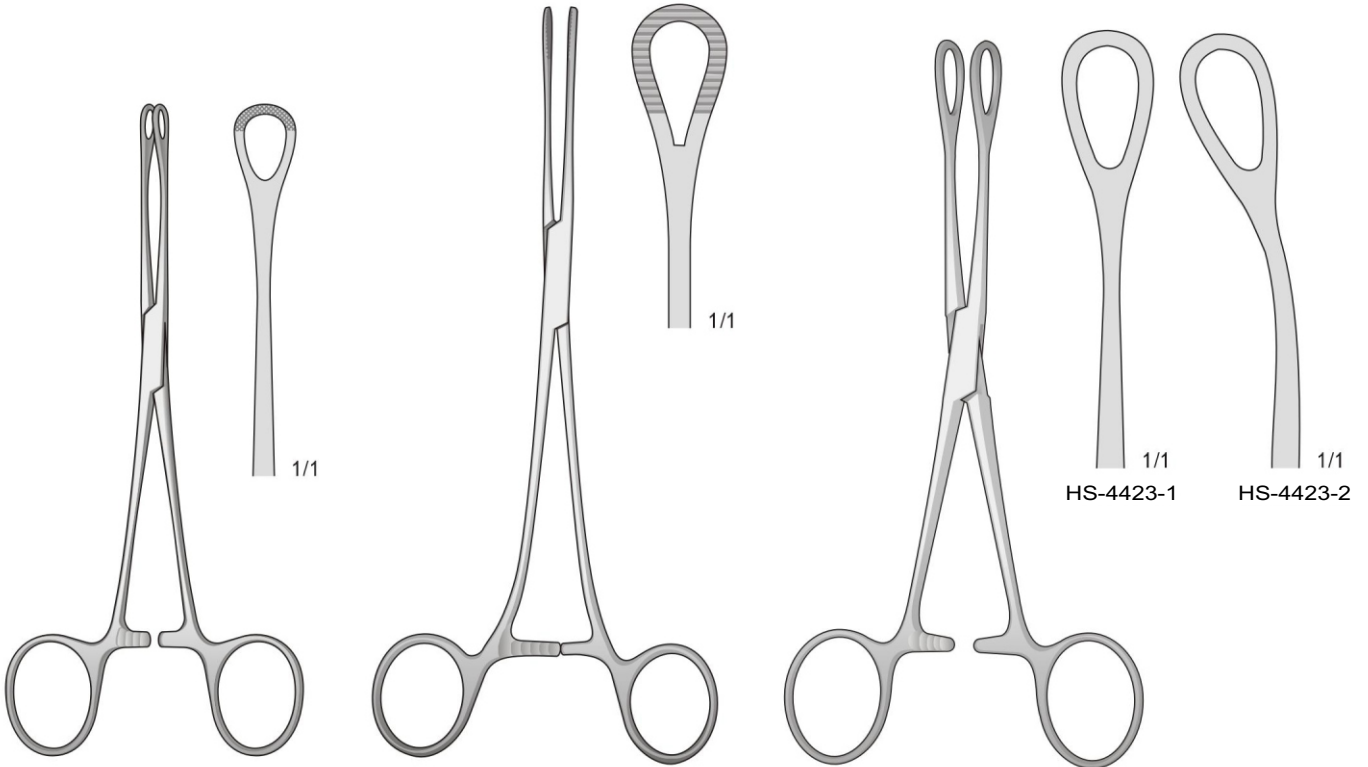

WILLIAMS  
 HS-4421  
 165 mm

HS-4422  
 200 mm

FOERSTER  
 HS-4423  
 180 mm

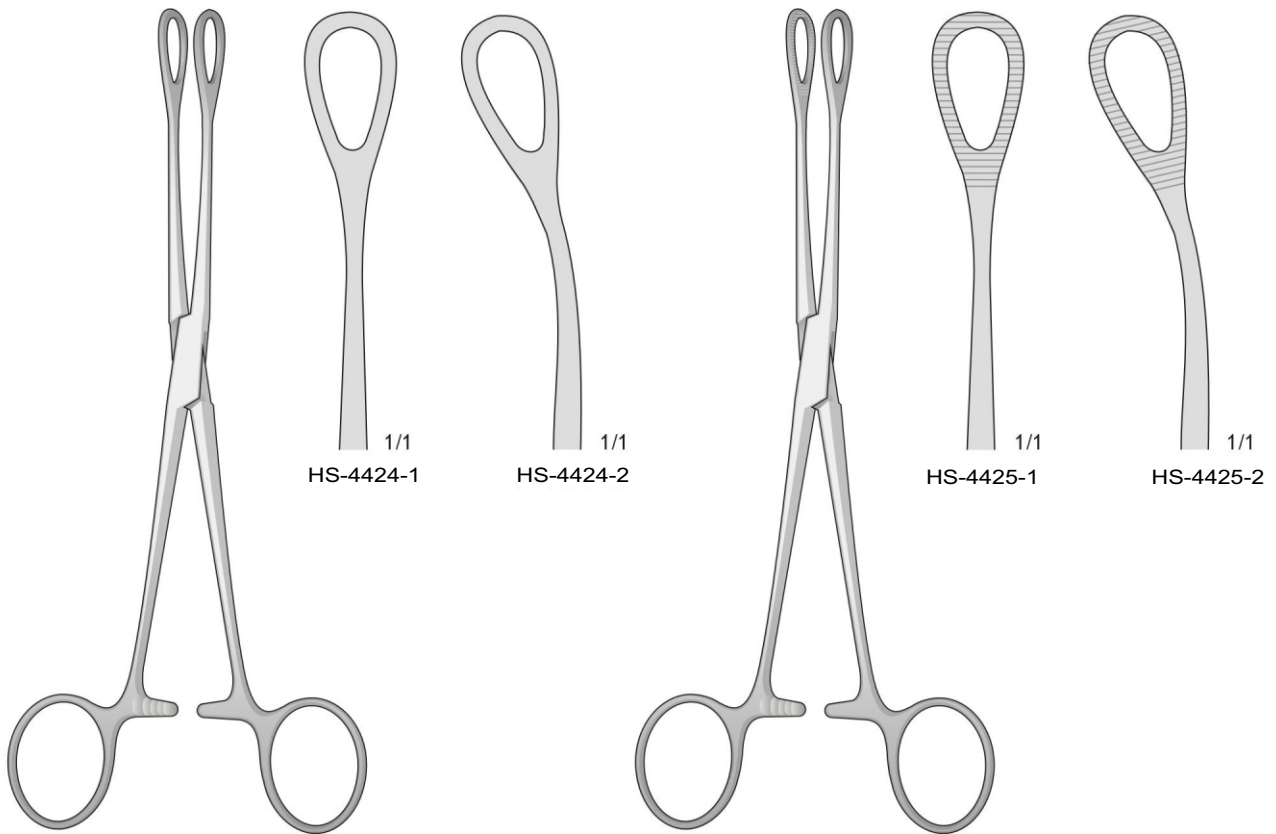

FOERSTER  
 HS-4424  
 200 mm

FOERSTER  
 HS-4425  
 200 mm



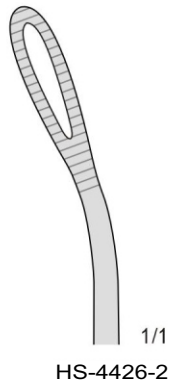
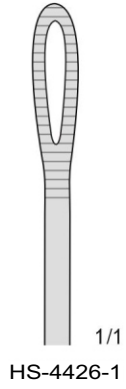
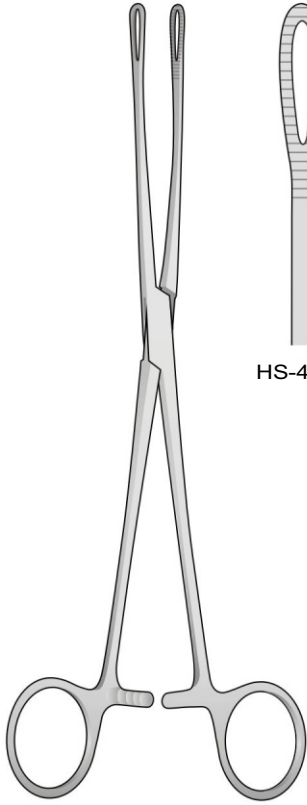

**FOERSTER**  
 HS-4426  
 250 mm

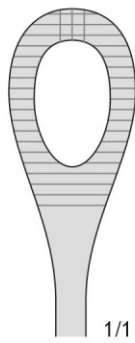
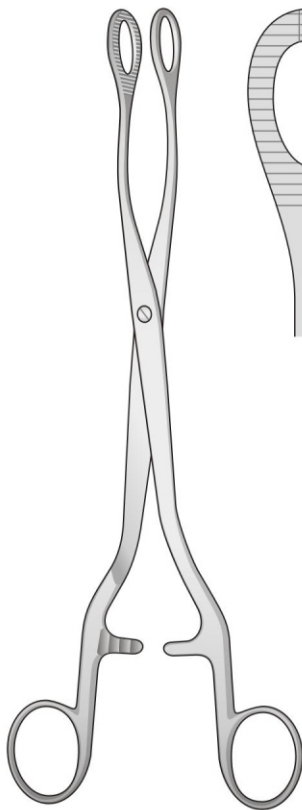

**HEYWOOD-SMITH**  
 HS-4427  
 250 mm

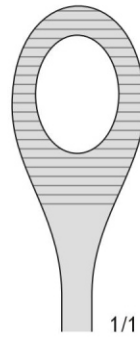
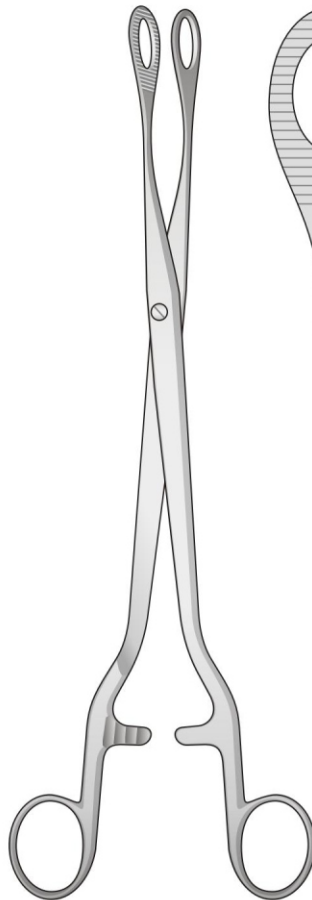

**NOTO**  
 HS-4428  
 280 mm

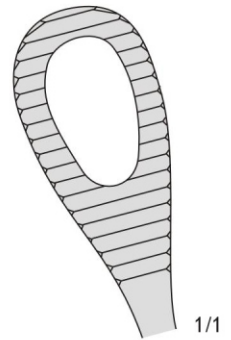
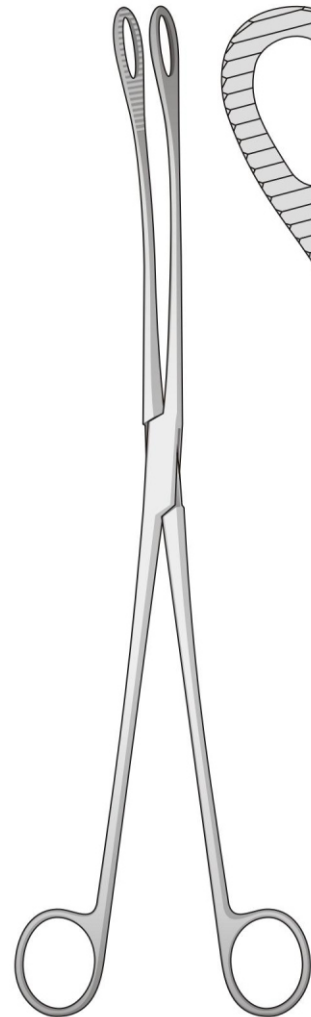

**KELLY**  
 HS-4429  
 320 mm

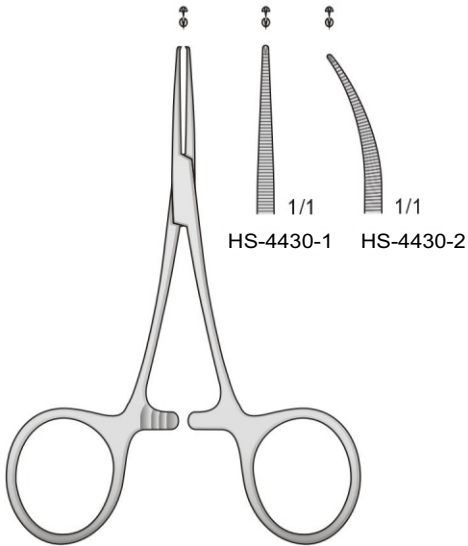

HARTMANN-BABY-MOSQUITO  
 HS-4430  
 95 mm

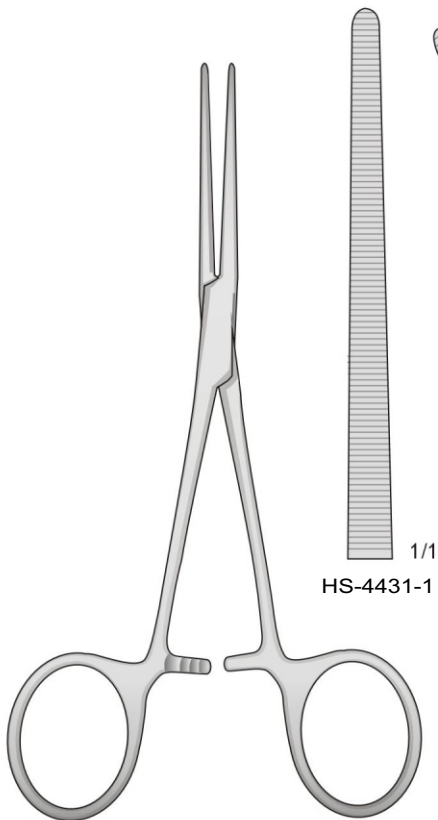

ROCHESTER-PEAN  
 HS-4431  
 225 mm

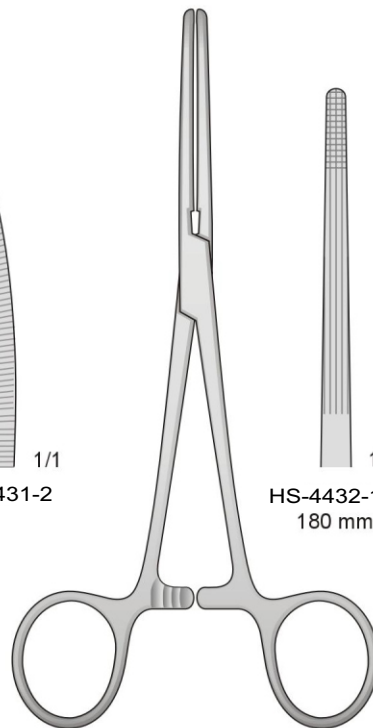
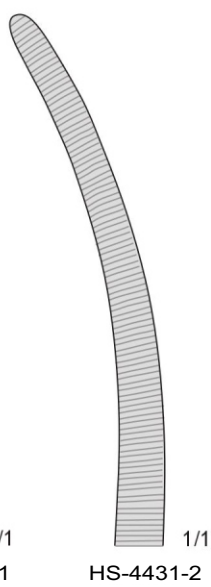

ROCHESTER-CARMALT  
 HS-4432

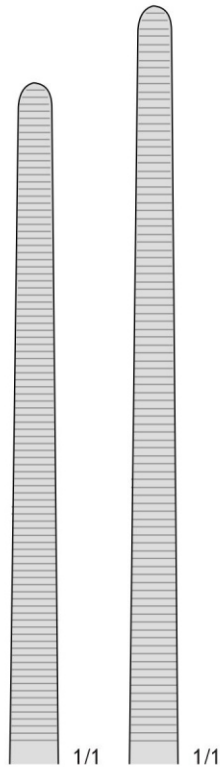

HS-4433-3 260 mm    HS-4433-4 280 mm

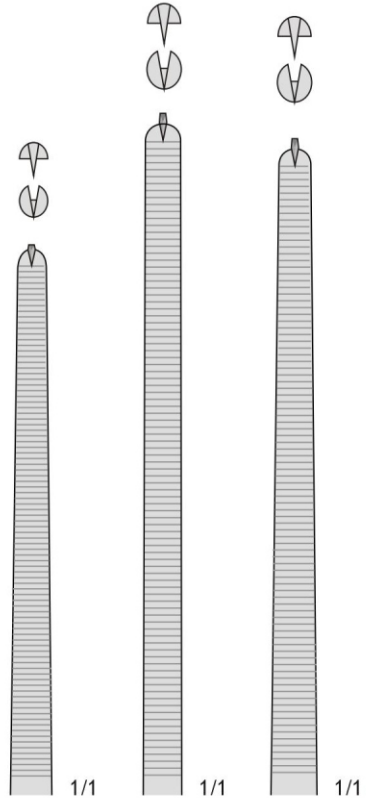

HS-4434-4 225 mm    HS-4434-5 260 mm    HS-4434-6 280 mm

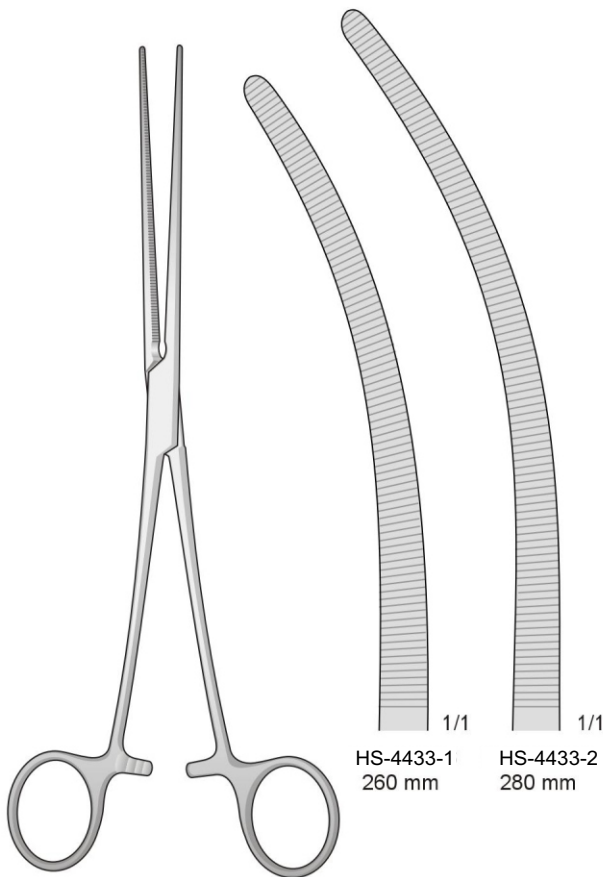

PEAN  
HS-4433

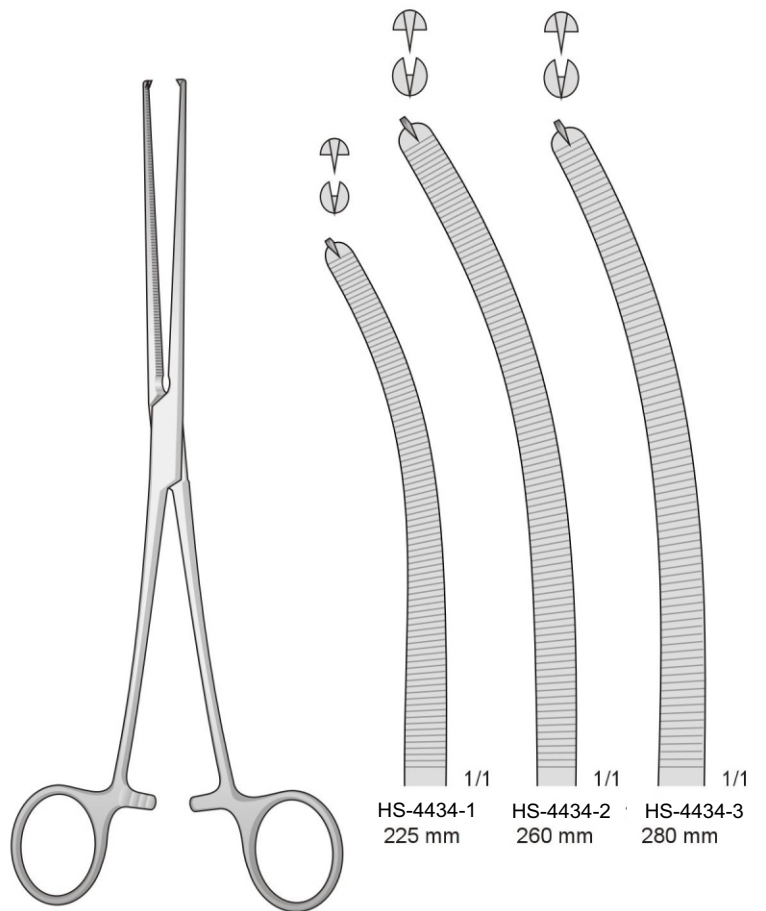

KOCHER-OCHSNER  
HS-4434

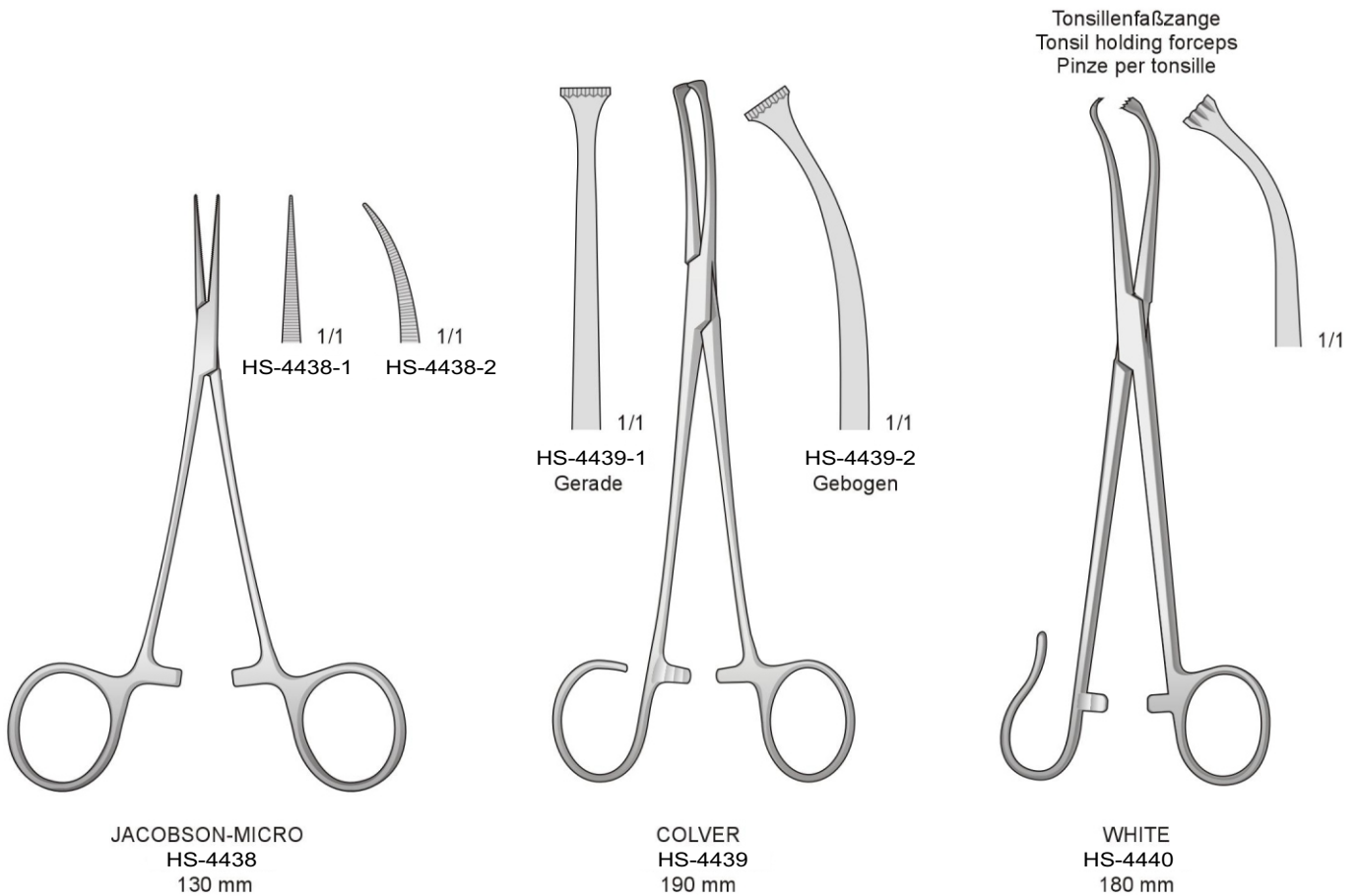
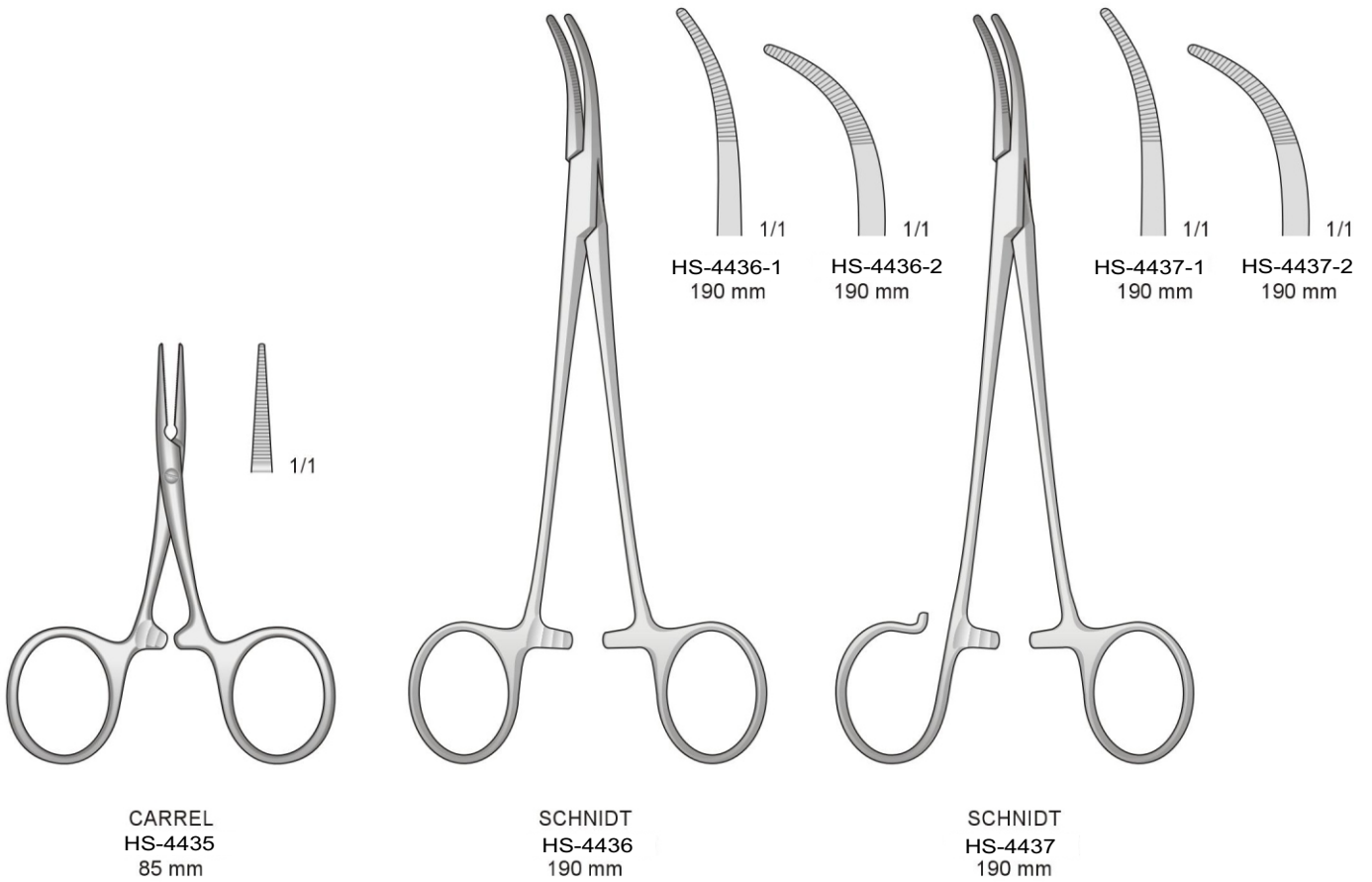

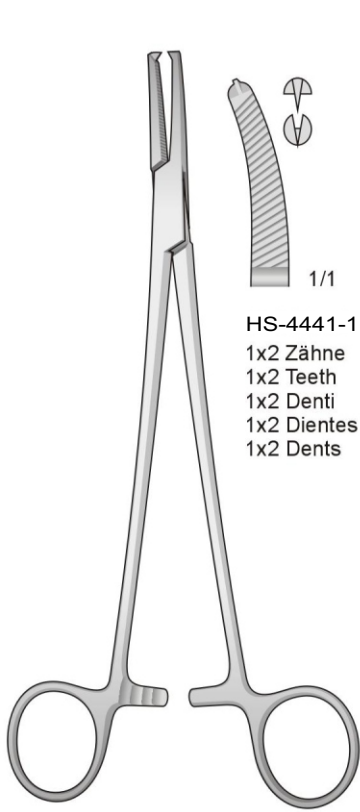

FAURE  
 HS-4441  
 200 mm

HS-4441-1  
 1x2 Zähne  
 1x2 Teeth  
 1x2 Denti  
 1x2 Dientes  
 1x2 Dents

HS-4441-2  
 1x2 Zähne  
 1x2 Teeth  
 1x2 Denti  
 1x2 Dientes  
 1x2 Dents

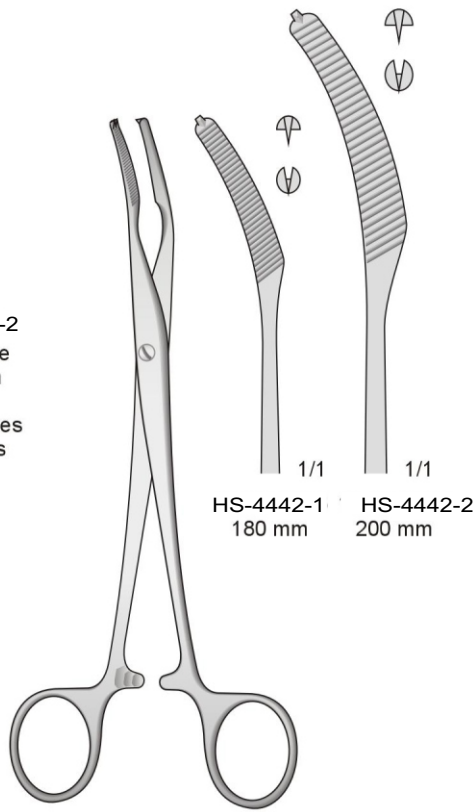

MIKULICZ  
 HS-4442

HS-4442-1  
 180 mm

HS-4442-2  
 200 mm

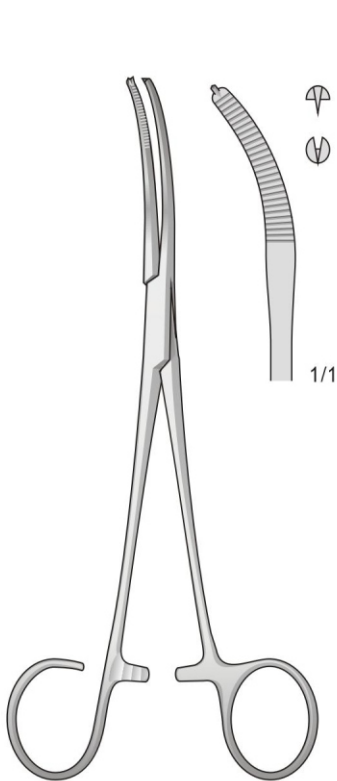

MIKULICZ  
 HS-4443  
 185 mm

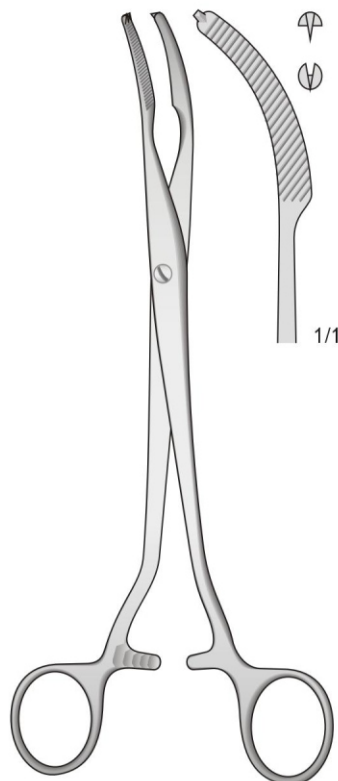

MIKULICZ  
 HS-4444  
 200 mm

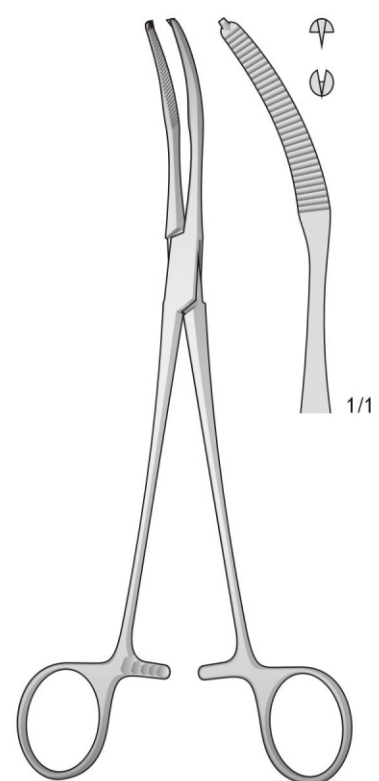

MIKULICZ  
 HS-4445  
 200 mm



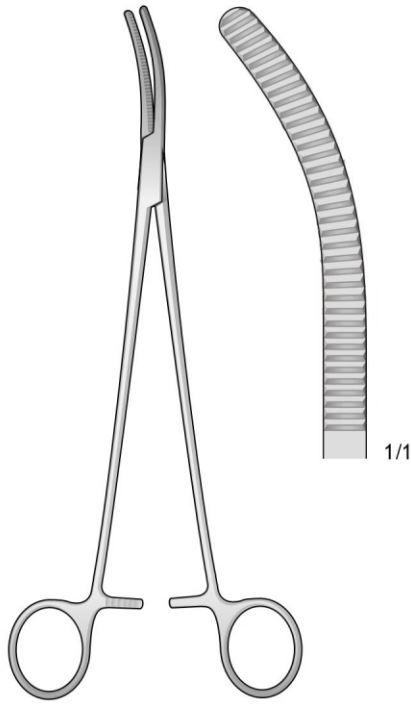

WERTHEIM  
 HS-4446  
 250 mm

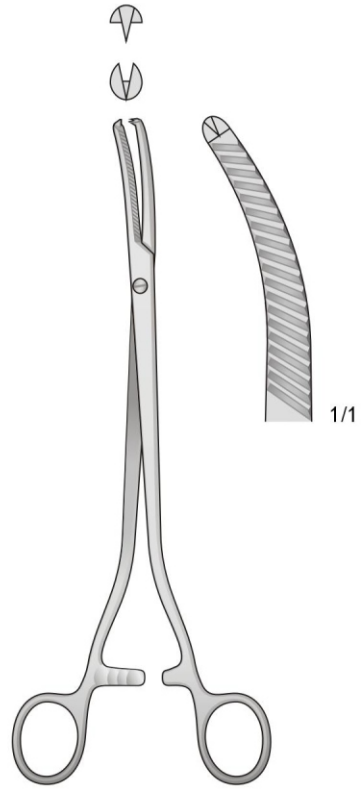

WERTHEIM  
 HS-4447  
 230 mm

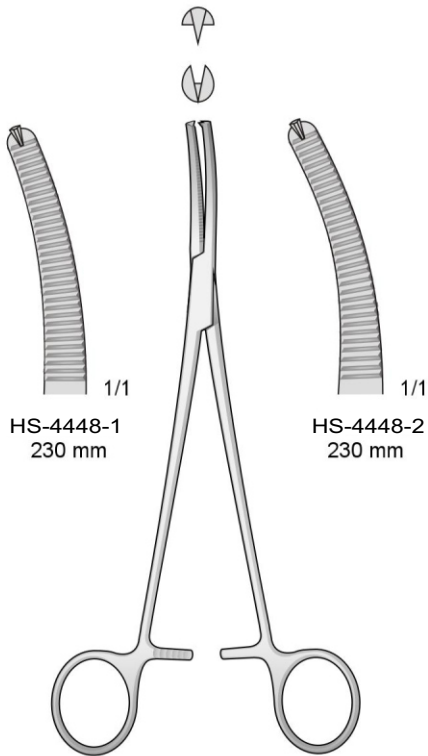

WERTHEIM  
 HS-4448  
 230 mm

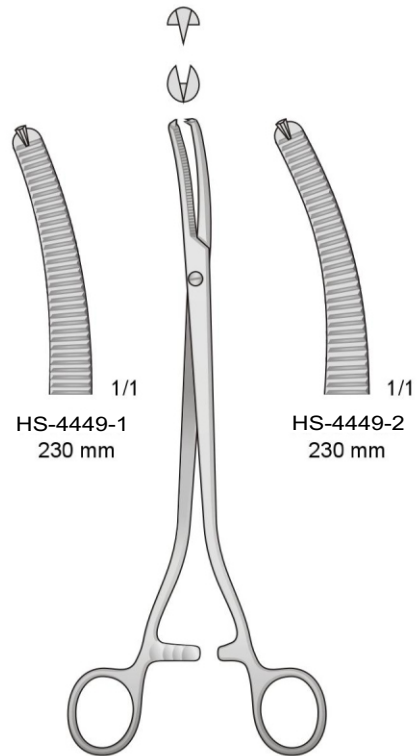

WERTHEIM  
 HS-4449  
 230 mm

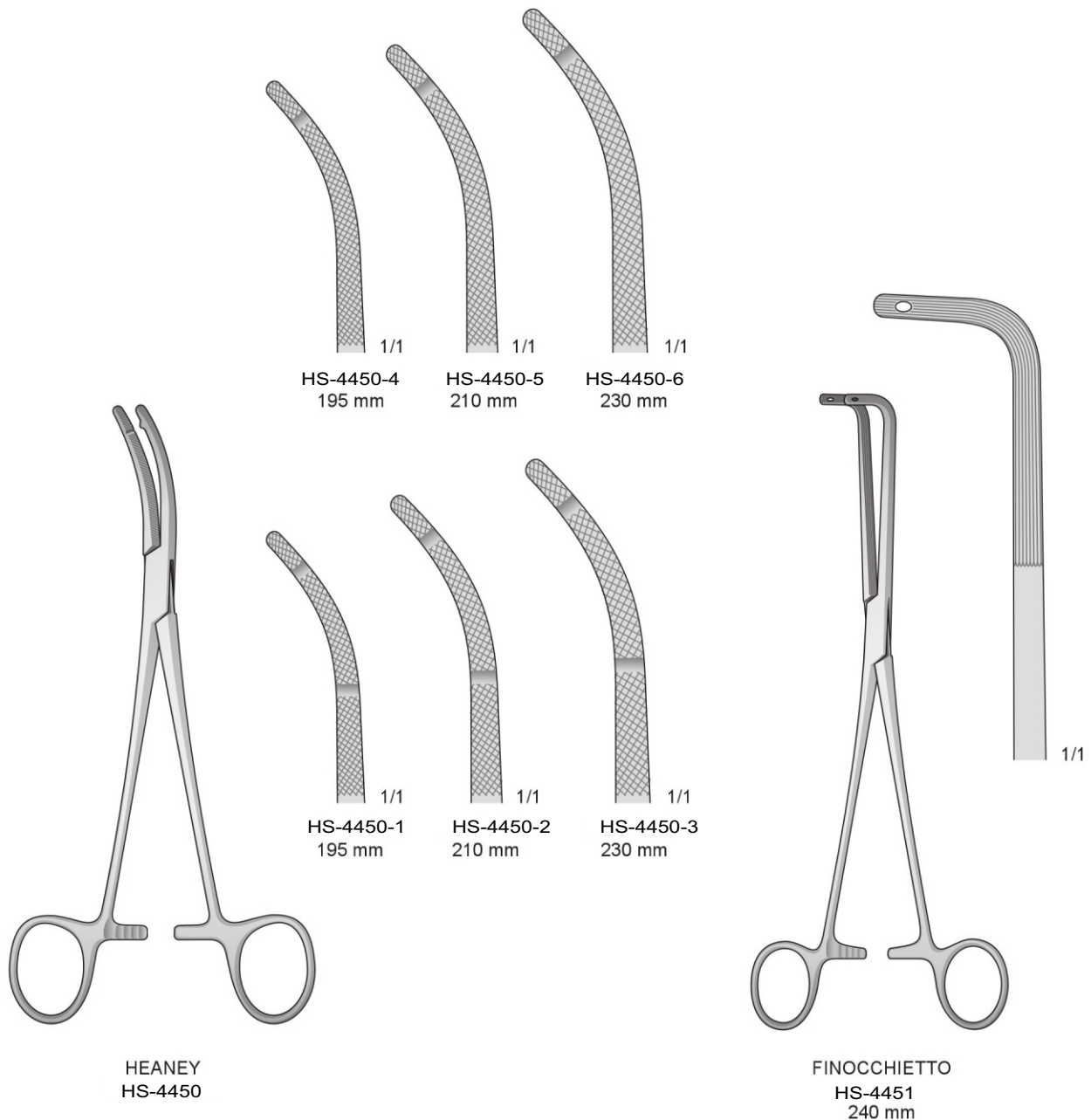

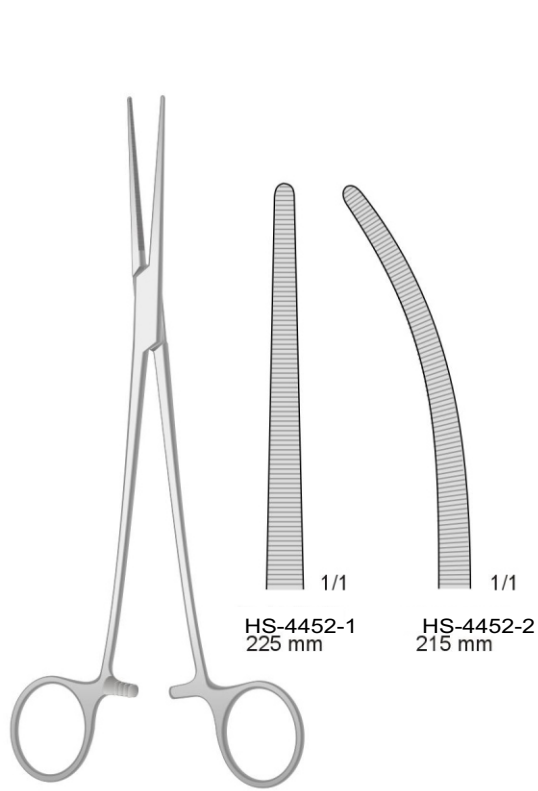

ROBERTS  
HS-4452

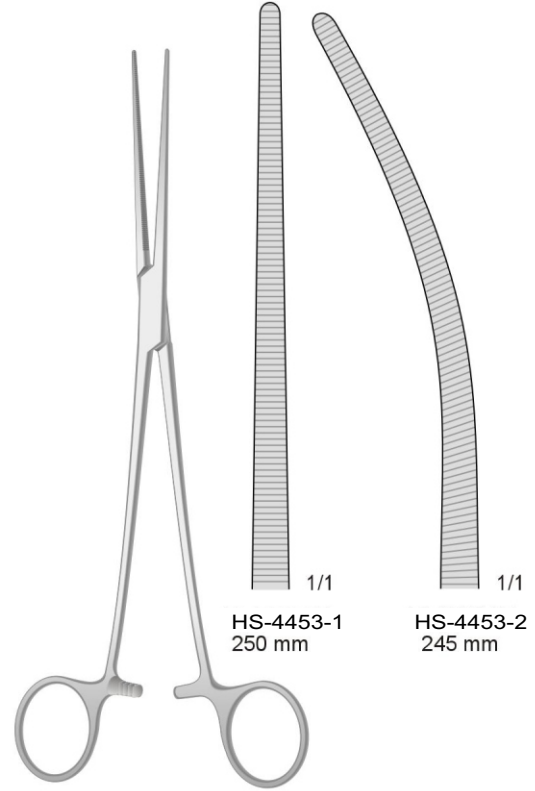

SAROT  
HS-4453

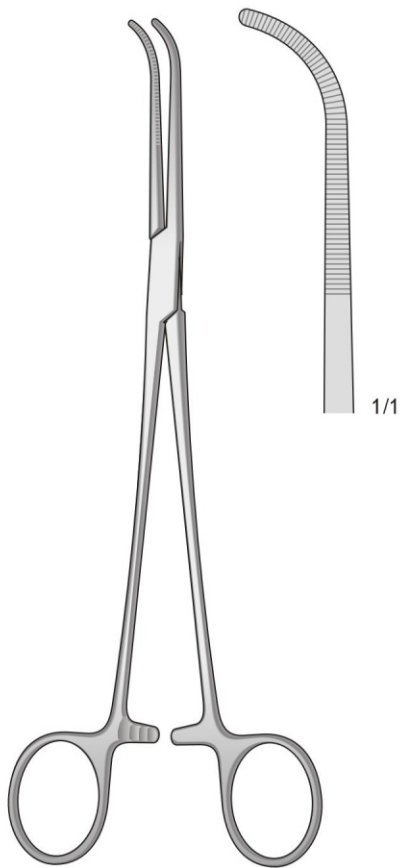

MIXTER  
HS-4454  
225 mm

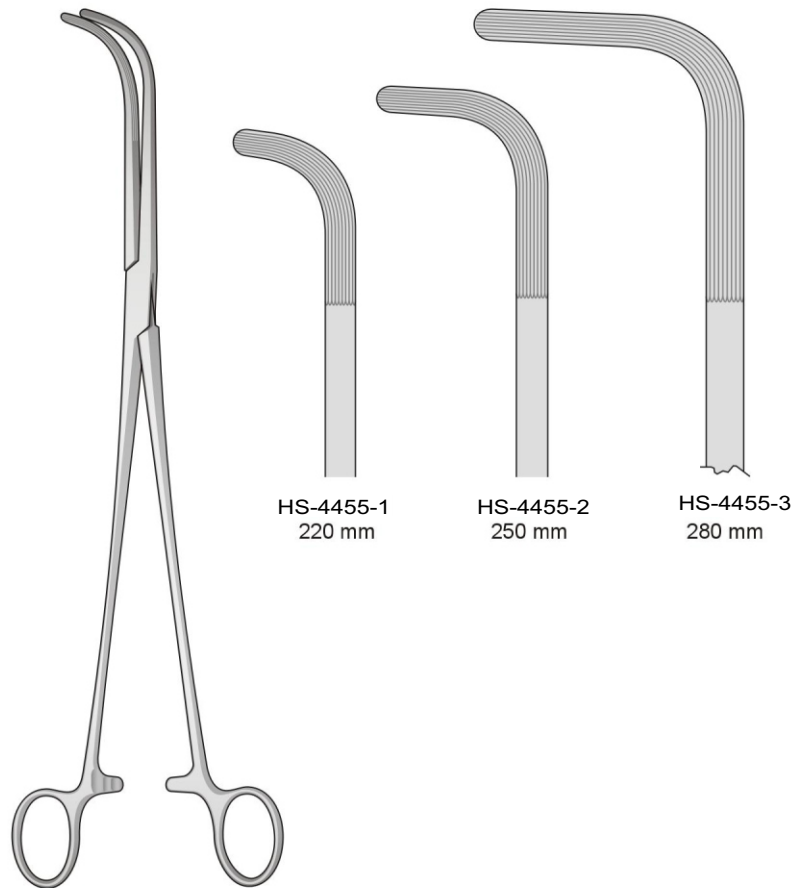

MIXTER  
HS-4455

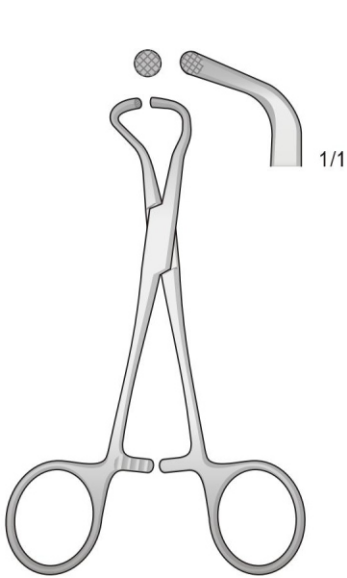

HS-4456  
100 mm

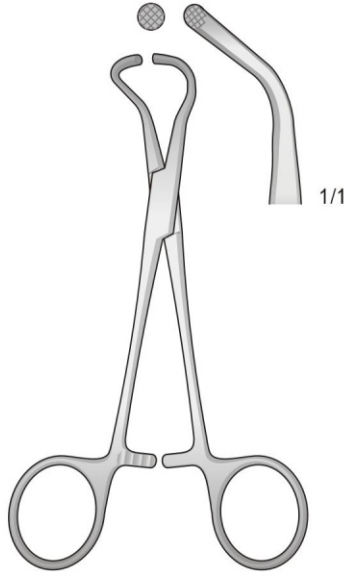

HS-4457  
125 mm

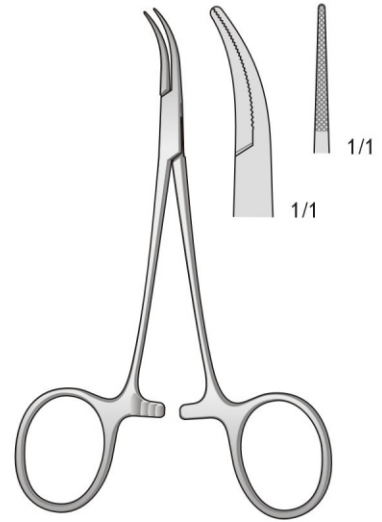

DANDY-MOSQUITO  
HS-4458  
120 mm

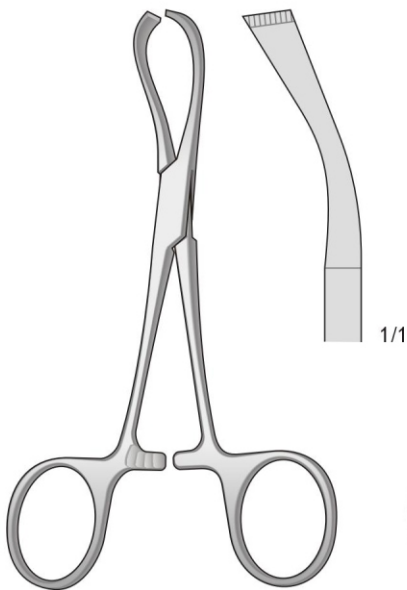

LORNA  
HS-4459  
130 mm

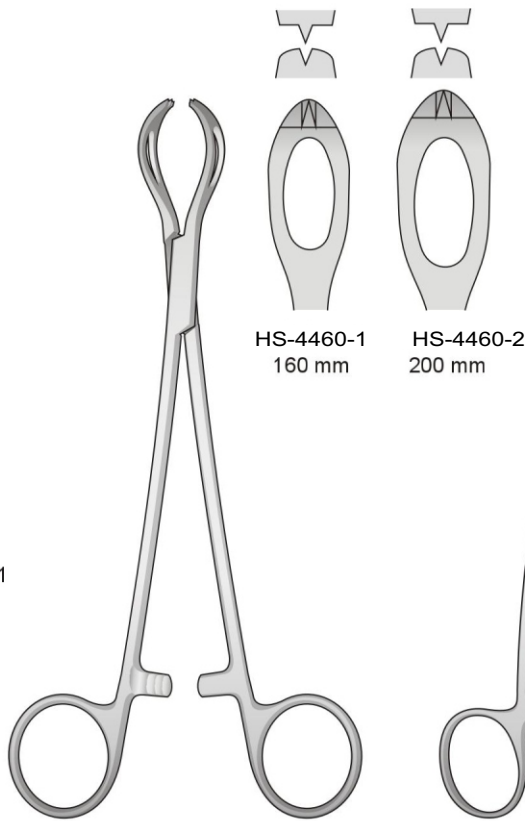

LANE  
HS-4460

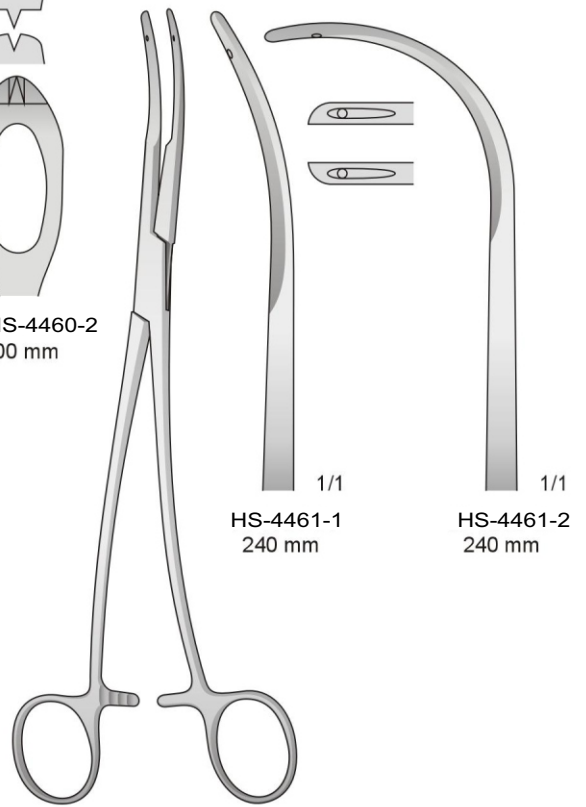

SEMB  
HS-4461  
240 mm

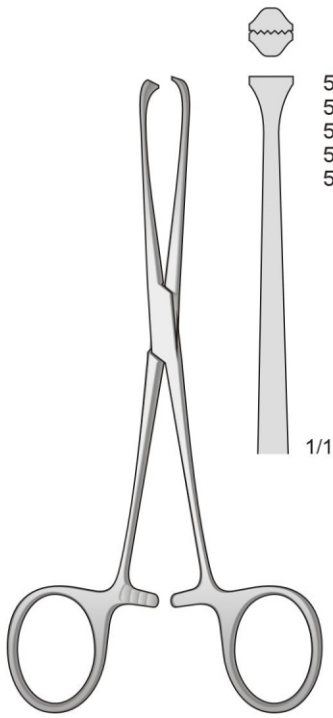

5x6 Zähne  
 5x6 Teeths  
 5x6 Denti  
 5x6 Dientes  
 5x6 Dents

1/1

**BOYS-ALLIS**  
 HS-4462  
 150 mm

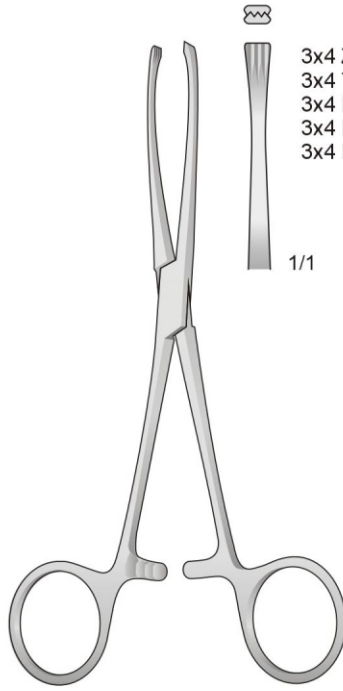

3x4 Zähne  
 3x4 Teeths  
 3x4 Denti  
 3x4 Dientes  
 3x4 Dents

1/1

**JUDD-ALLIS**  
 HS-4463  
 155 mm

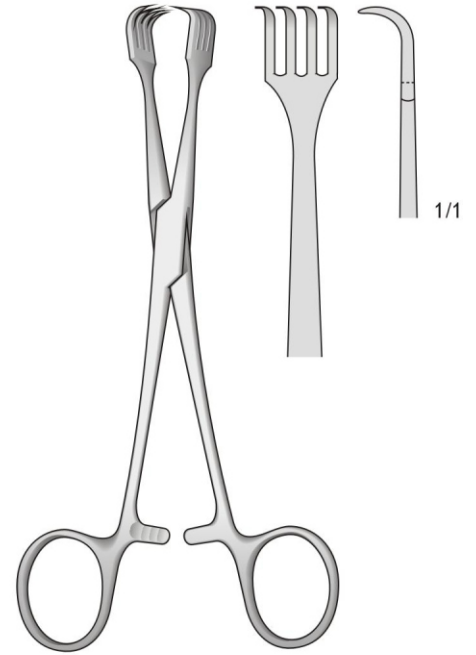

1/1

**BRAUN**  
 HS-4464  
 155 mm

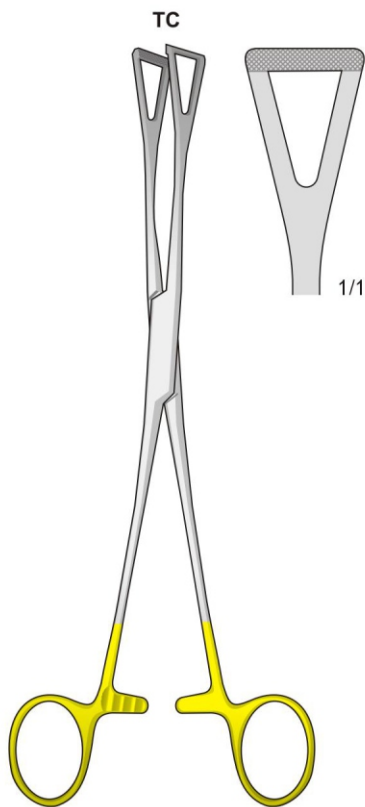

TC

1/1

**DUVAL**  
 HS-4465  
 200 mm

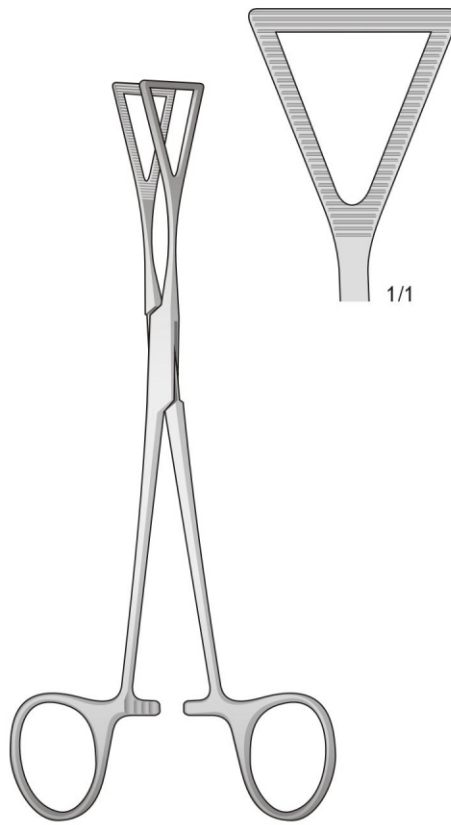

1/1

**LOVELACE**  
 HS-4466  
 200 mm

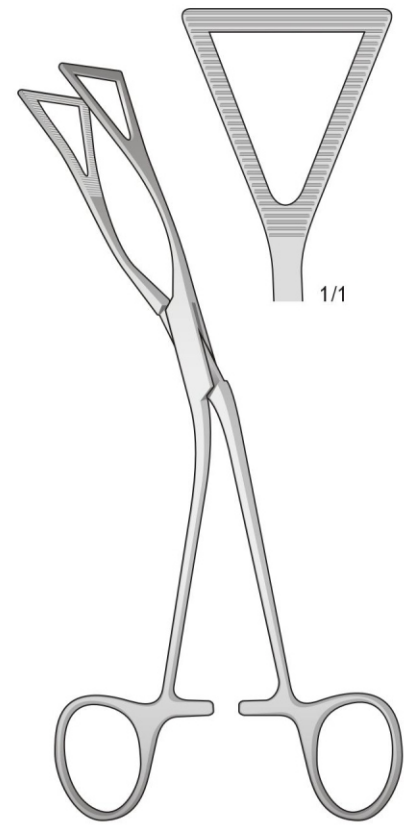

1/1

**LOVELACE**  
 HS-4467  
 200 mm





PEET  
 HS-4468  
 120 mm

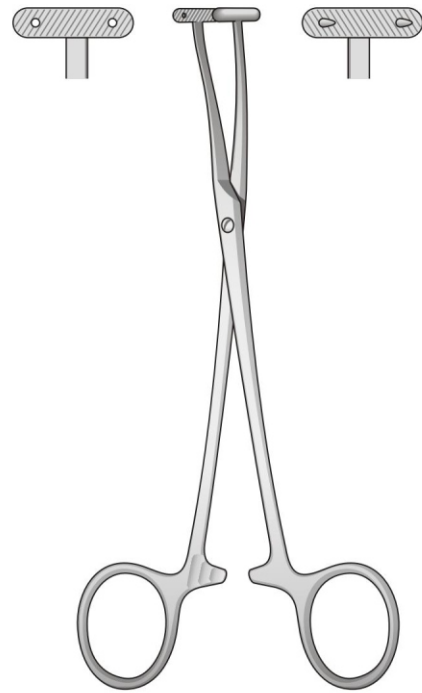

DE MARTEL  
 HS-4469  
 180 mm



MIXTER  
 HS-4470  
 220 mm

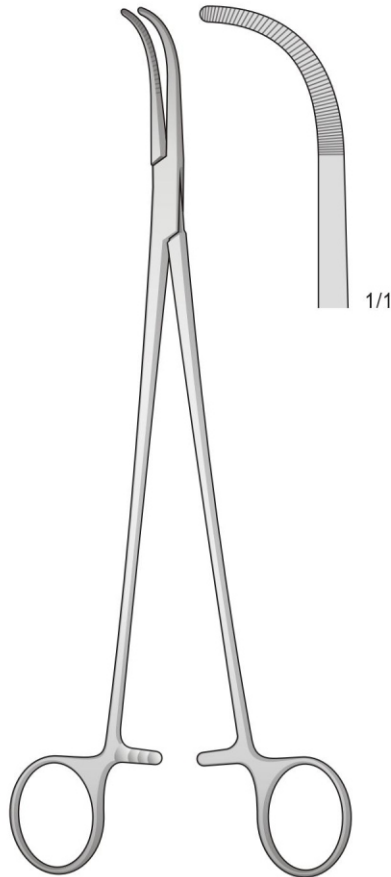

MIXTER  
 HS-4471  
 230 mm

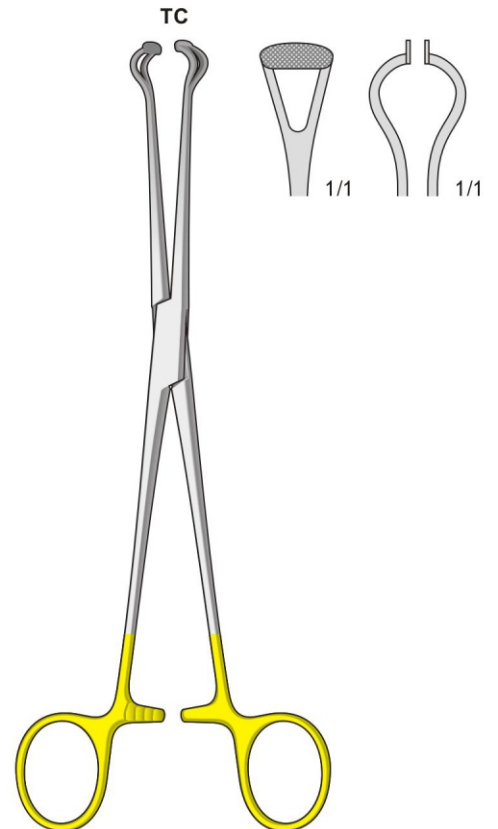

BABCOCK  
 HS-4472  
 210 mm

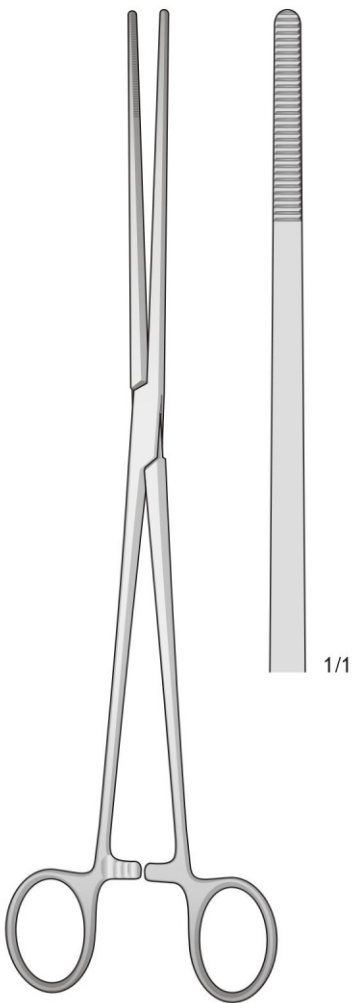

BOZEMANN  
HS-4473  
260 mm

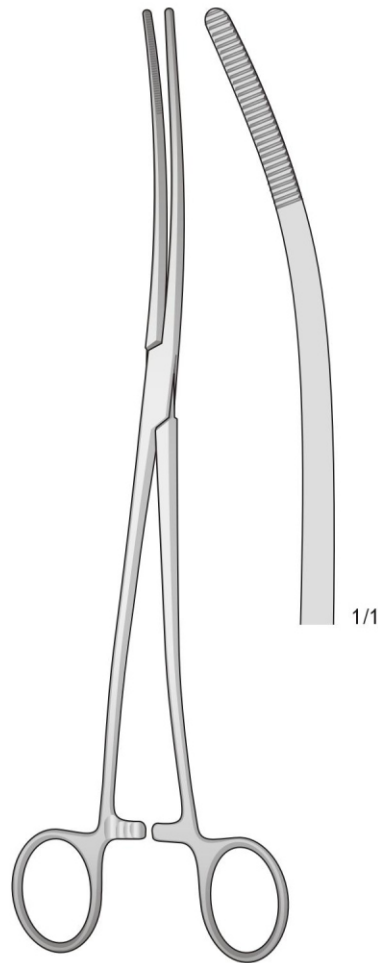

BOZEMANN  
HS-4474  
260 mm

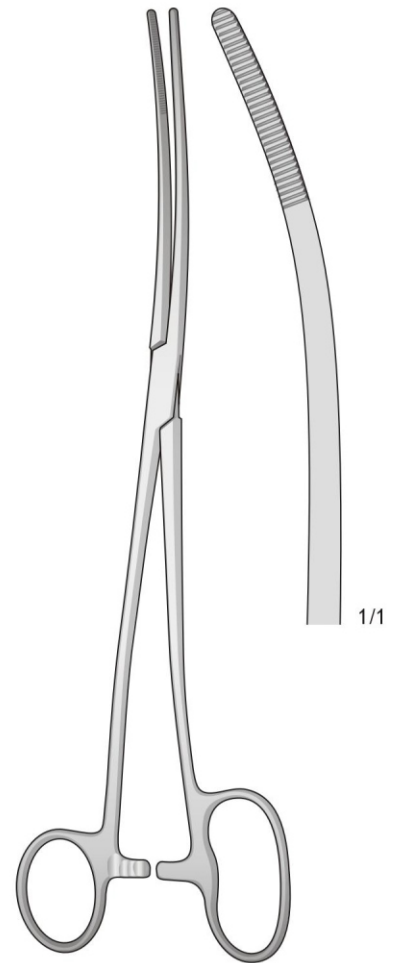

BOZEMANN-DOUGLAS  
HS-4475  
260 mm



De BAKEY

Atraumatiche



De BAKEY

Atraumatiche

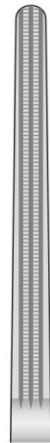

HS-4477-1  
250 mm

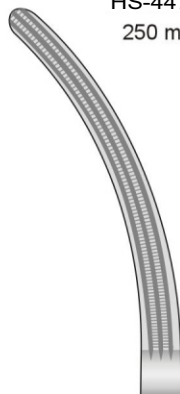

18-1900-02  
HS-4477-2

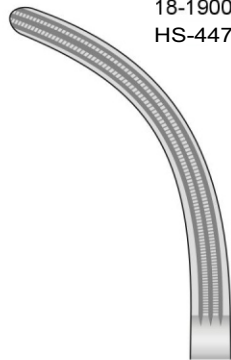

HS-4477-3  
240 mm

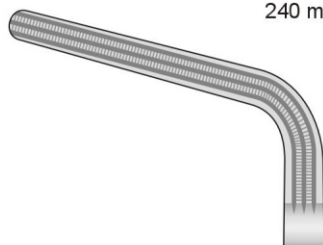

HS-4477-4  
230 mm

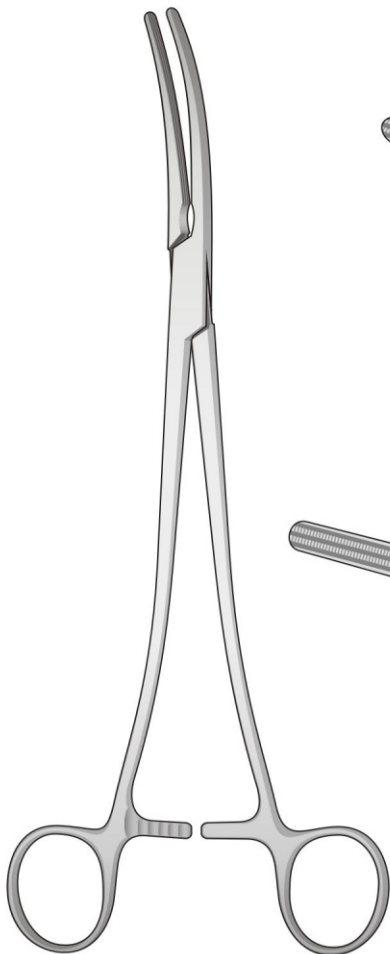

HS-4477  
WERTHEIM

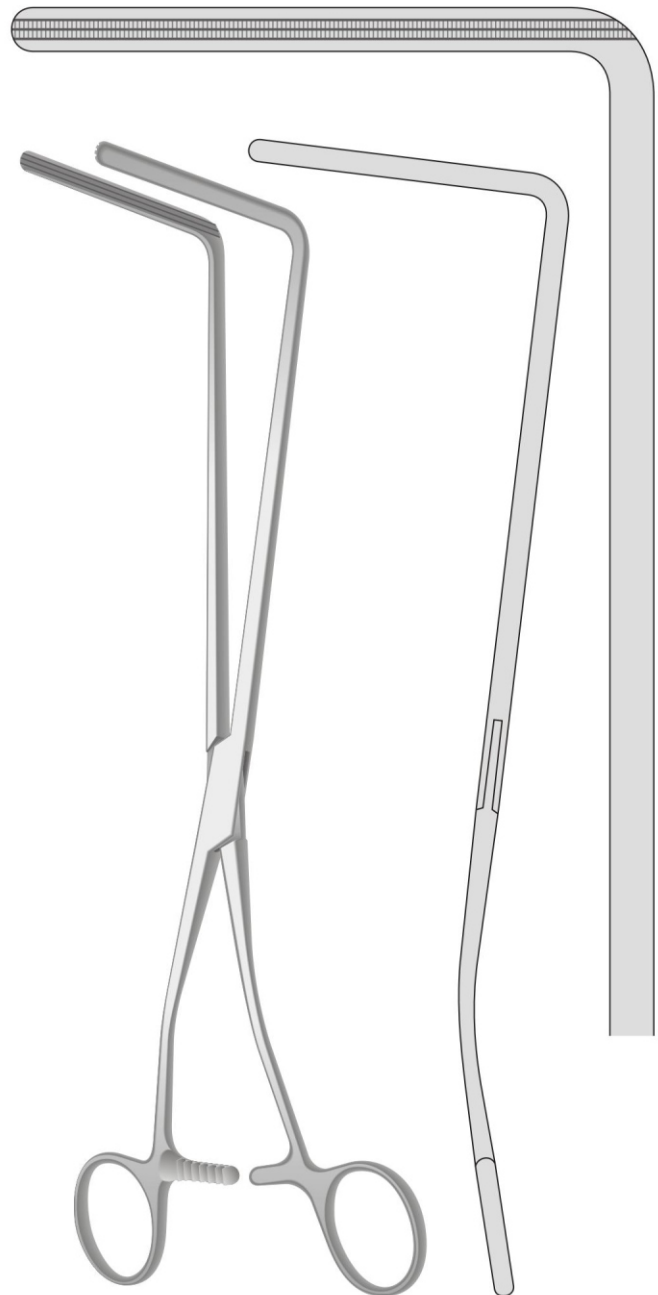

RESANO  
HS-4476  
280 mm

1/1

Weich und elastisch  
 With soft and  
 elastic blades

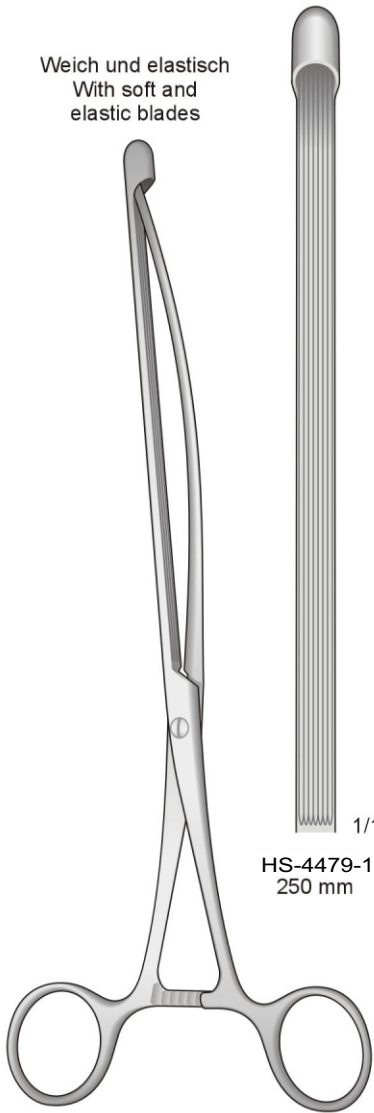

HS-4479-1  
 250 mm

NUSSBAUM  
 HS-4479  
 250 mm

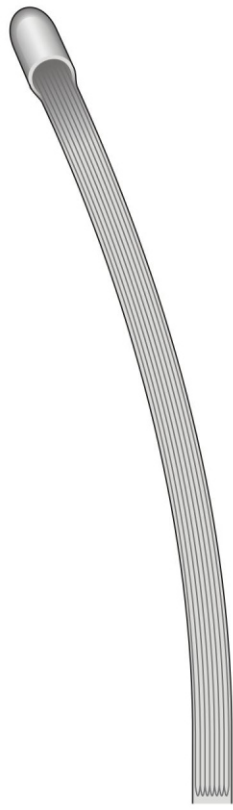

HS-4479-2  
 250 mm

Atrauma

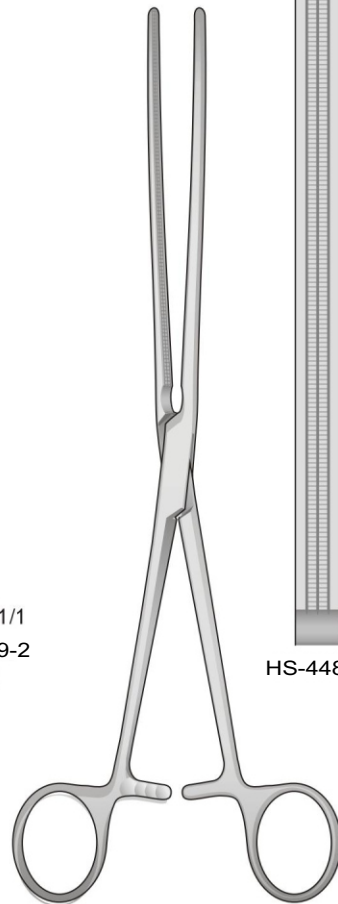

HS-4480-1

DOYEN  
 HS-4480  
 230 mm

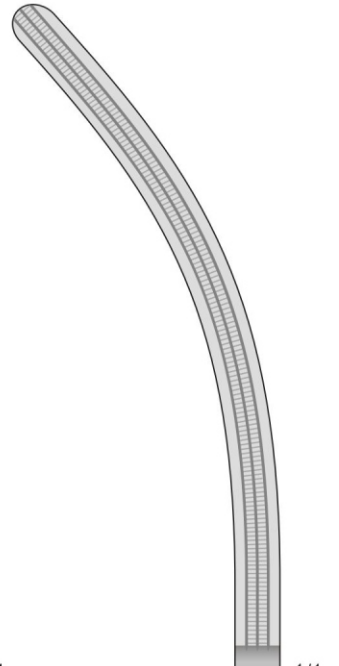

HS-4480-2

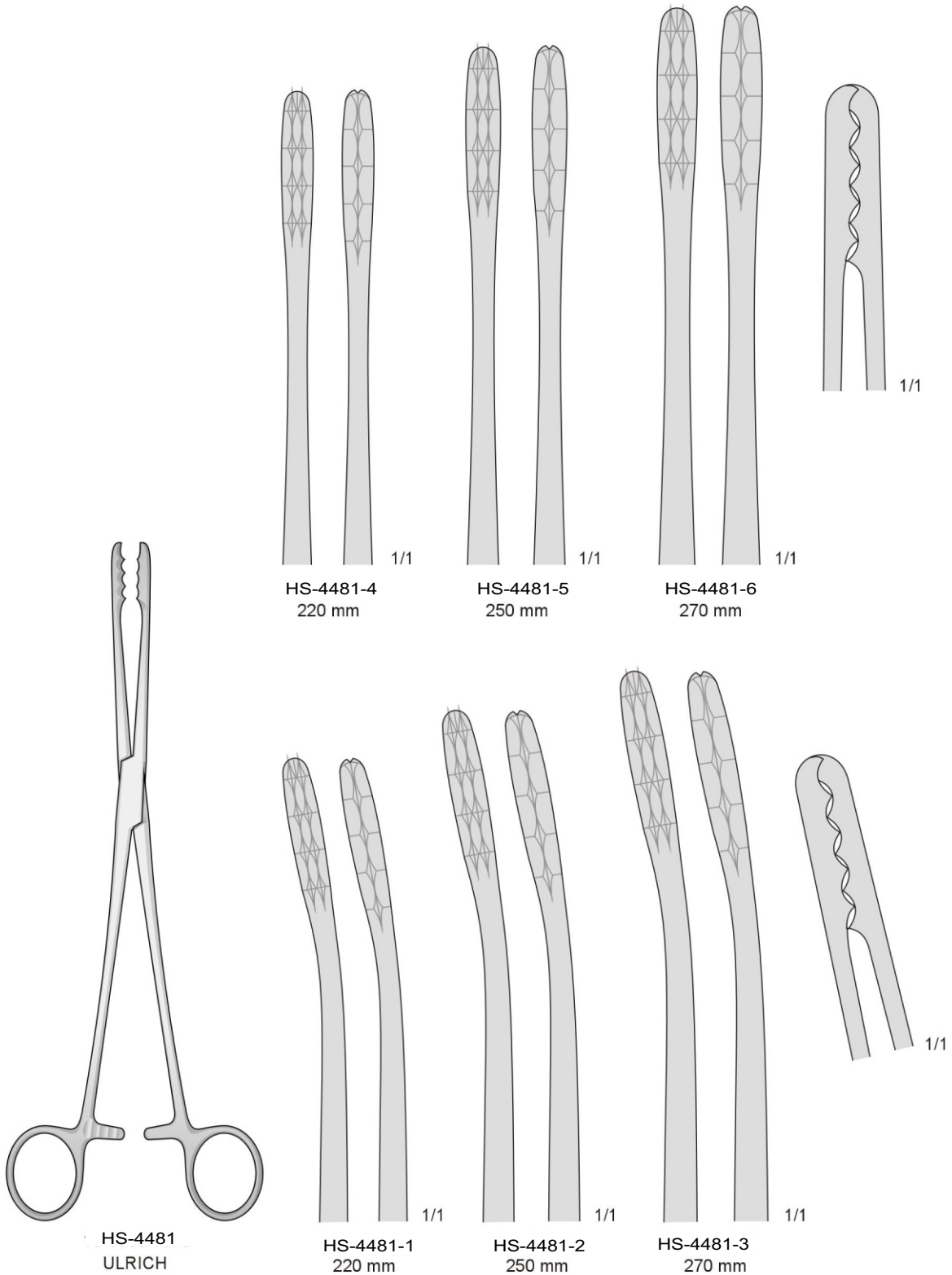





Titan - Titanium - Titanio - Titane

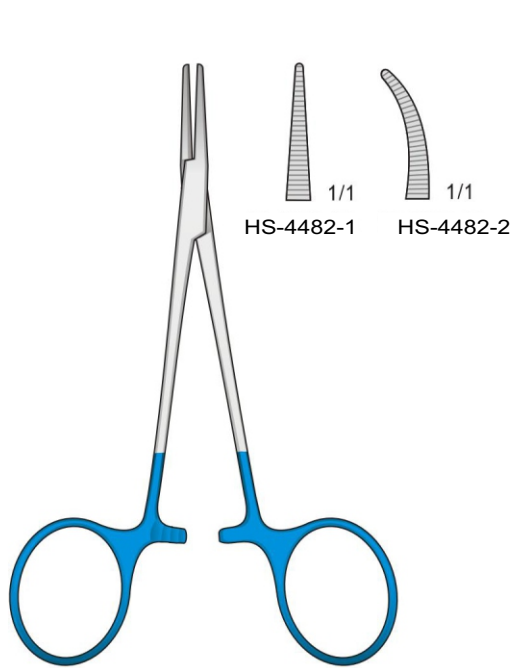

HALSTED-MOSQUITO  
HS-4482  
120 mm

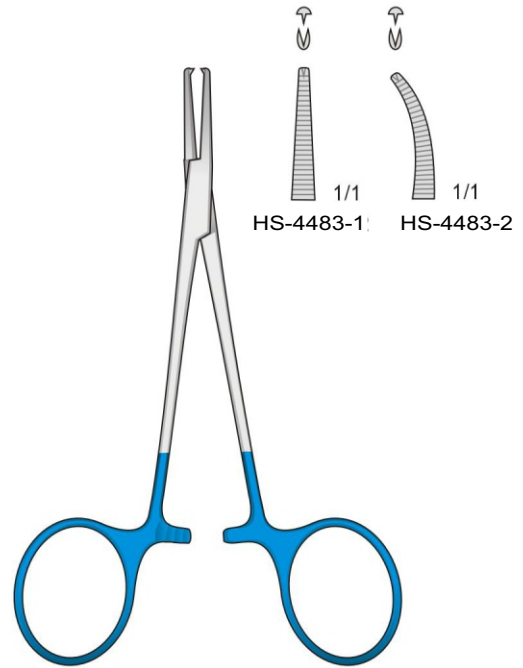

HALSTED-MOSQUITO  
HS-4483  
120 mm

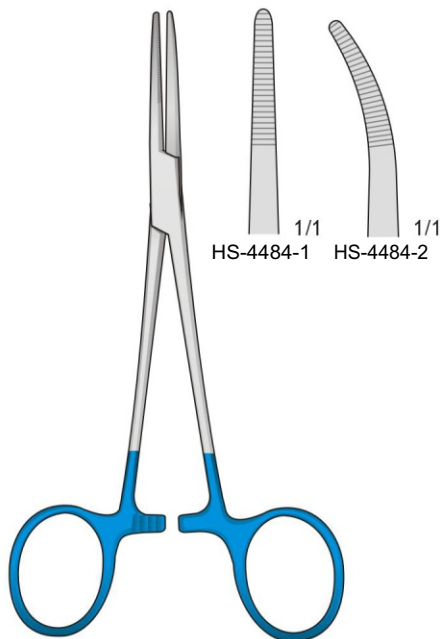

KELLY  
HS-4484  
140 mm

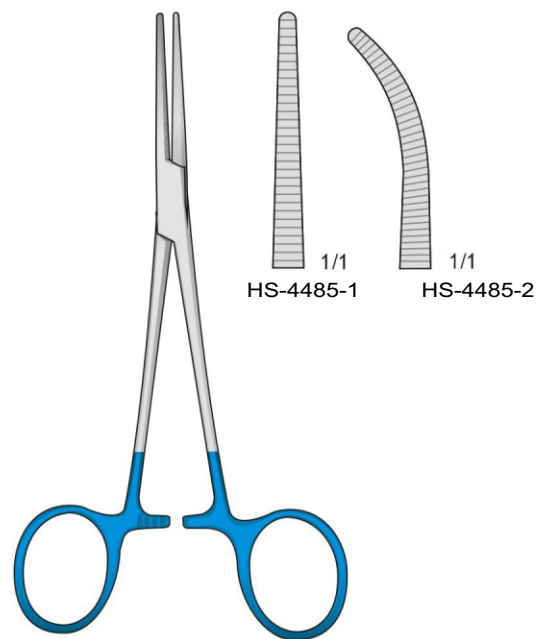

CRILE  
HS-4485  
140 mm

18-2060  
Krampfaderbesteck komplett  
Varicose Vein Probe Set complete  
Set completo sonda per varici  
Juego para varices completo  
Trousse à varices complète

Metall-Sondenspitzen  
Probe tip, metal  
Punta per sonda  
in metallo  
Punta metálica  
Pointe en métal

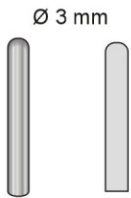

Ø 3 mm

HS-4486



HS-4487

Oliven - Olives - Olive - Oliva - Olive

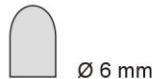

Ø 6 mm

HS-4487-1



Ø 9 mm

HS-4487-2

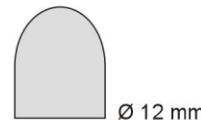

Ø 12 mm

HS-4487-3

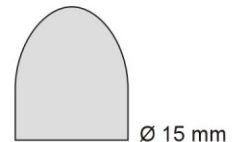

Ø 15 mm

HS-4487-4

Griff Allein  
Handle only  
Manico solo  
Mango solo  
Manche seule



HS-4488

Zugseil  
Traction Cable  
Cavo per trazione  
Cable de tracción  
Cable tracteur

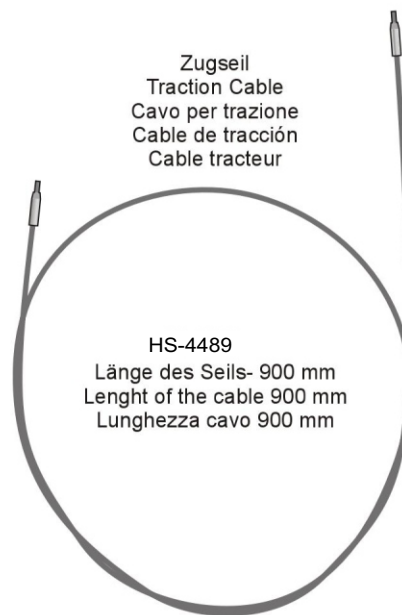

HS-4489  
Länge des Seils- 900 mm  
Length of the cable 900 mm  
Lunghezza cavo 900 mm

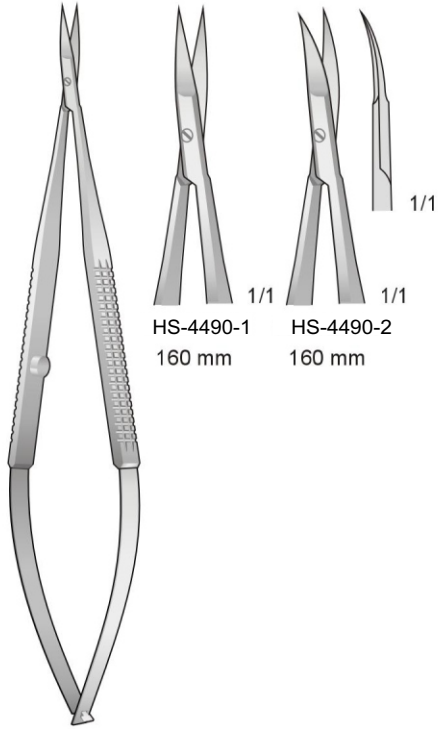

HS-4490  
160 mm

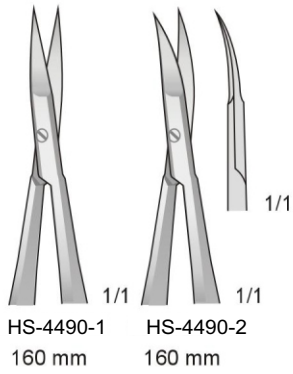

HS-4490-1  
160 mm

HS-4490-2  
160 mm

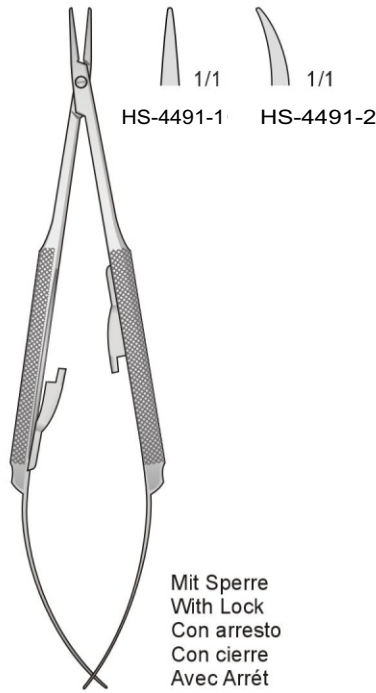

BARRAQUER  
HS-4491  
150 mm

Mit Sperre  
With Lock  
Con arresto  
Con cierre  
Avec Arrêt

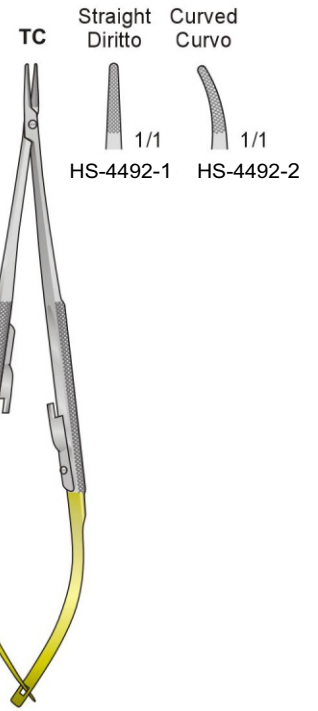

CASTROVIEJO  
HS-4492  
140 mm

Nadelhalter mit Hartmetalleinlagen - Needle Holders with tungsten-carbide inserts  
Portaghi con inserti al tungsteno - Portaagujas con plaquetas de carburo de tungsteno  
Porte aiguilles avec plaquettes en carbure de tungstène

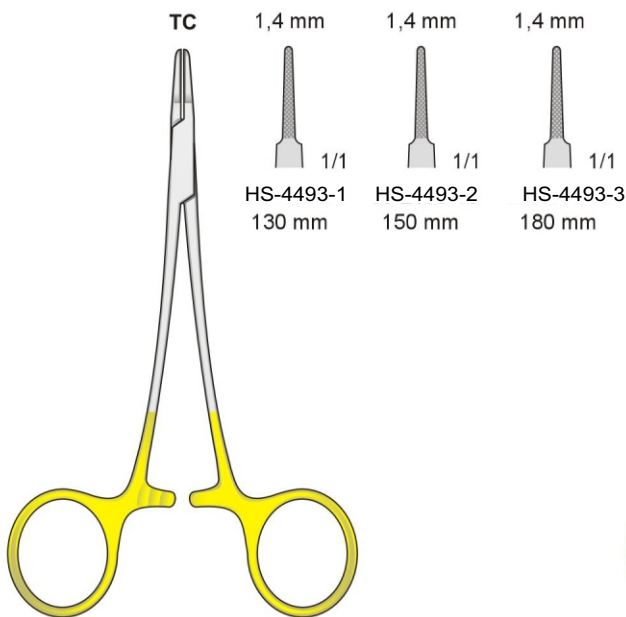

MICRO-RYDER  
HS-4493

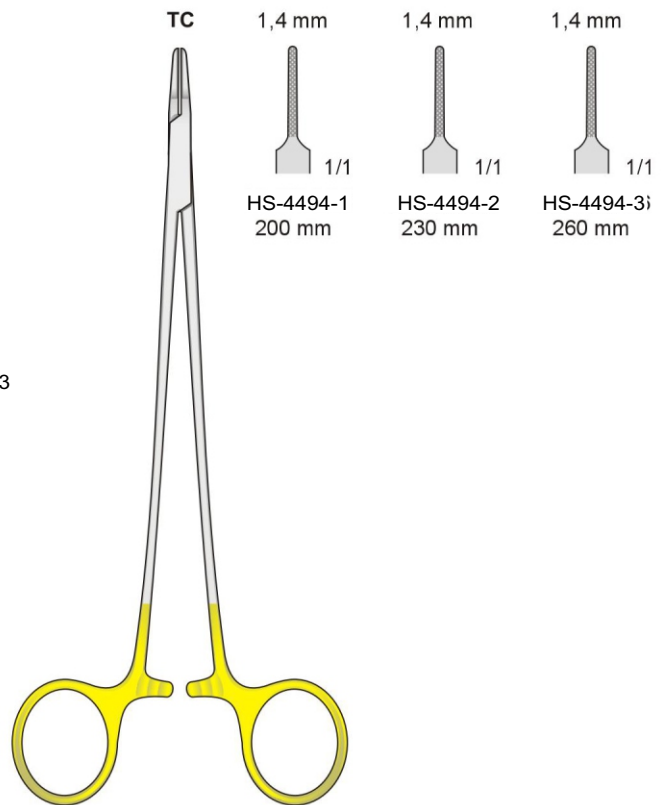

MICRO-RYDER  
HS-4494

Nadelhalter mit Hartmetalleinlagen - Needle Holders with tungsten-carbide inserts - Portaghi con inserti al tungsteno  
Portaagujas con plaquitas de carburo de tungsteno - Porte aiguilles avec plaquettes en carbure de tungstène

Ein Ring abgewinkelt  
One ring angled  
Un anello angolato

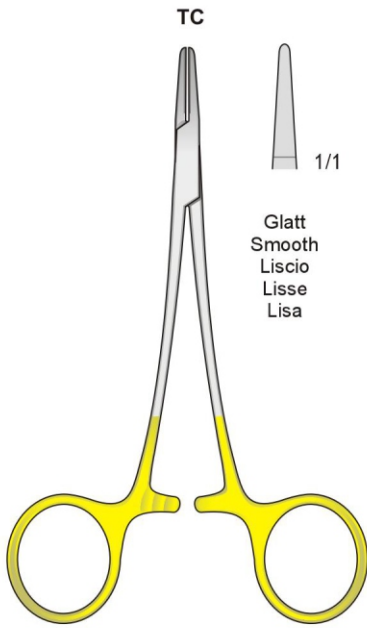

HALSEY  
HS-4495  
130 mm

Glatt  
Smooth  
Liscio  
Lisse  
Lisa

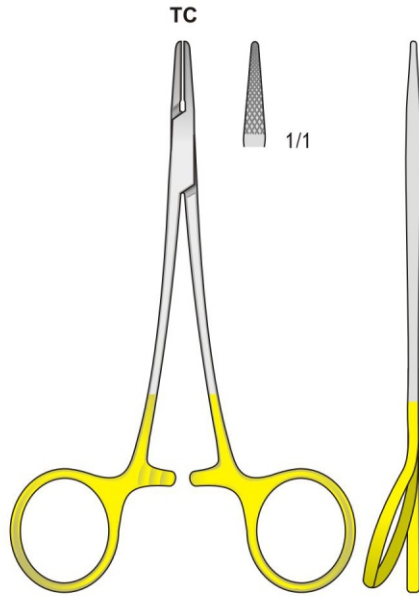

HS-4496  
120 mm

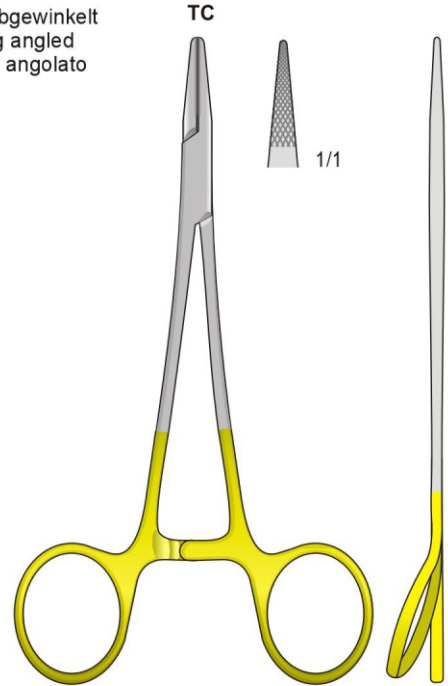

CRILE-WOOD  
HS-4497  
150 mm

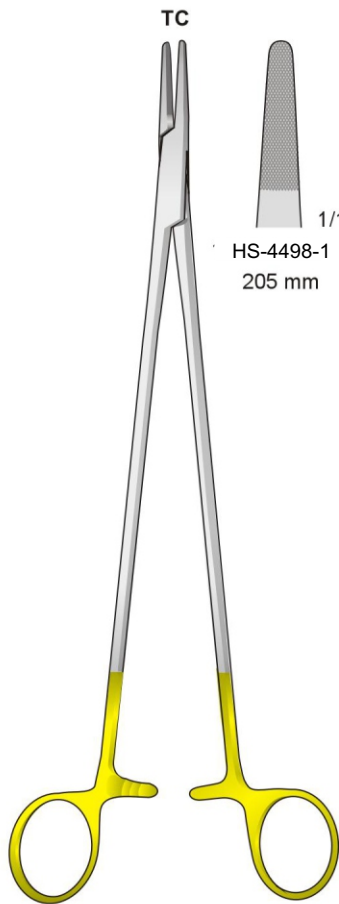

HEGAR  
HS-4498

HS-4498-1  
205 mm

HS-4498-2  
245 mm

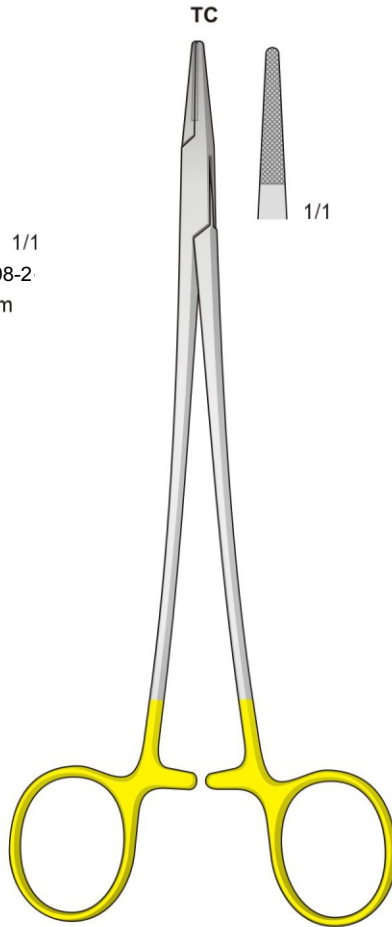

DE BAKEY  
HS-4499  
370 mm

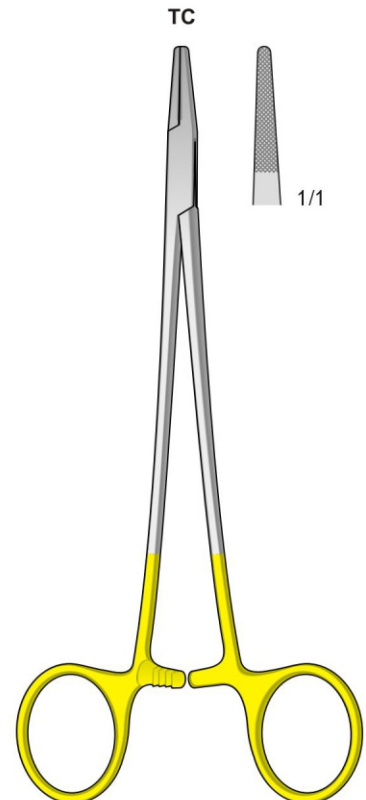

DeBAKEY  
HS-4500  
200 mm

**Needle Holders**

Für Linkshänder - Left Handed  
Per mancini - Pour gauche - Para zurdos

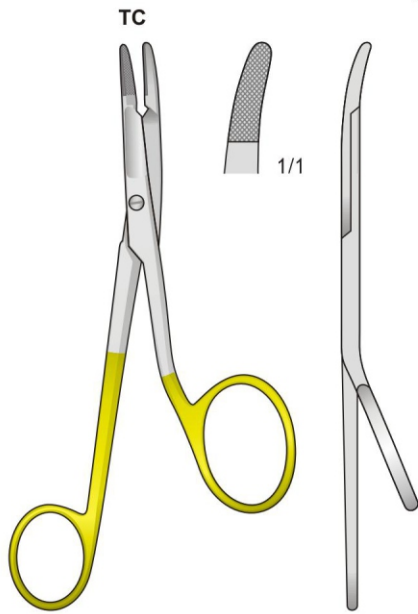

GILLIES  
HS-4501  
160 mm

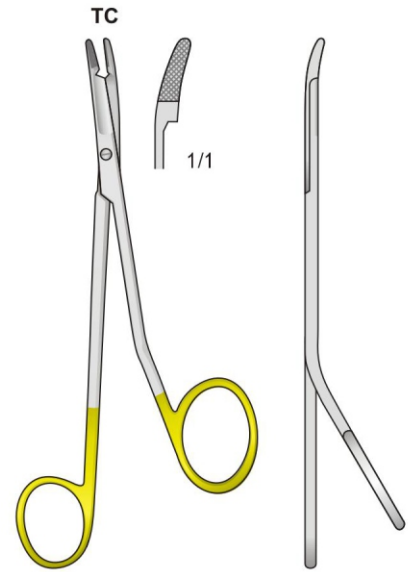

MINI-GILLIES  
HS-4502  
145 mm

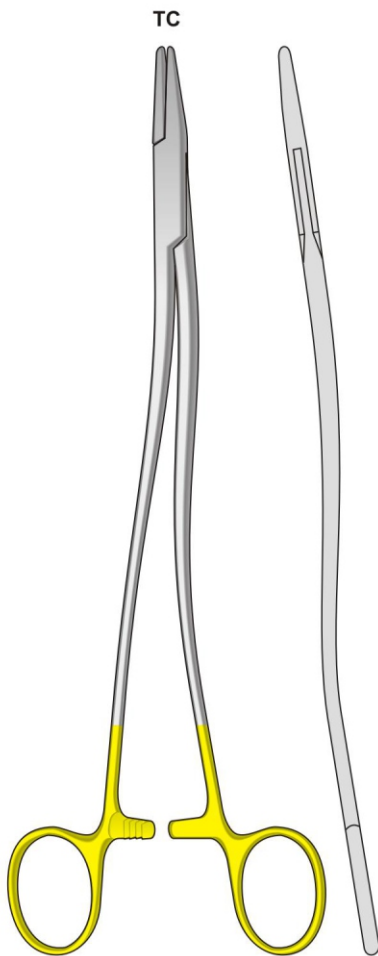

BOZEMANN  
HS-4503

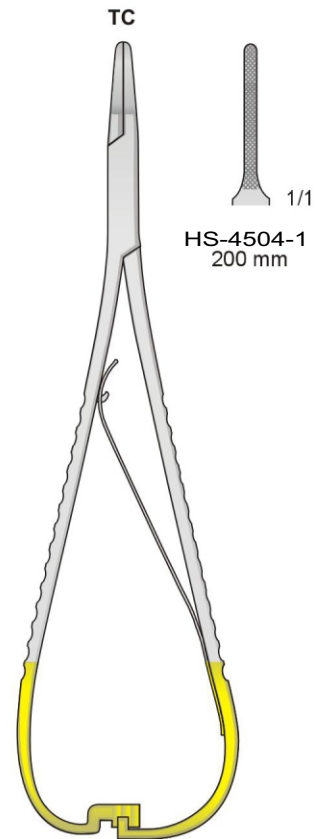
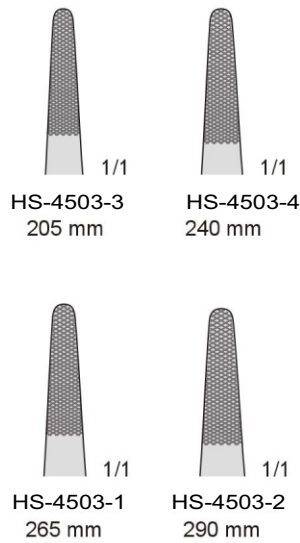

LICHTENBERG  
HS-4504  
175 mm



Kräftiges Modell  
 Heavy pattern  
 Modelo robusto  
 Modèle robuste

TC

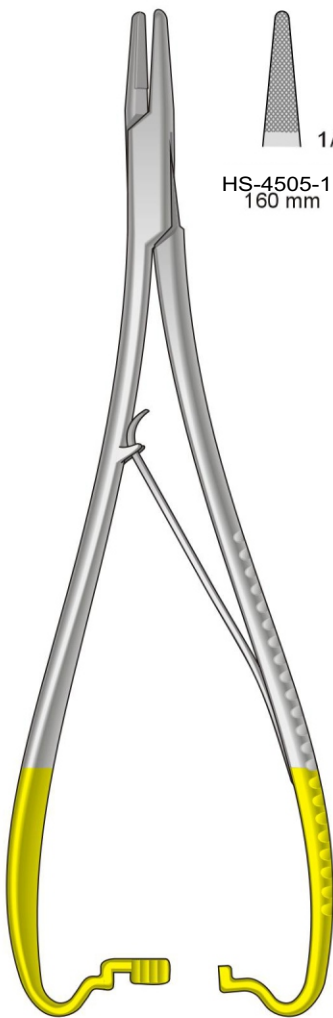

MATHIEU  
 HS-4505

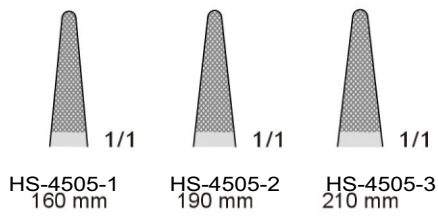

Atraumatische - Atraumatic  
 Atraumatiche - Atraumáticas  
 Atraumatique

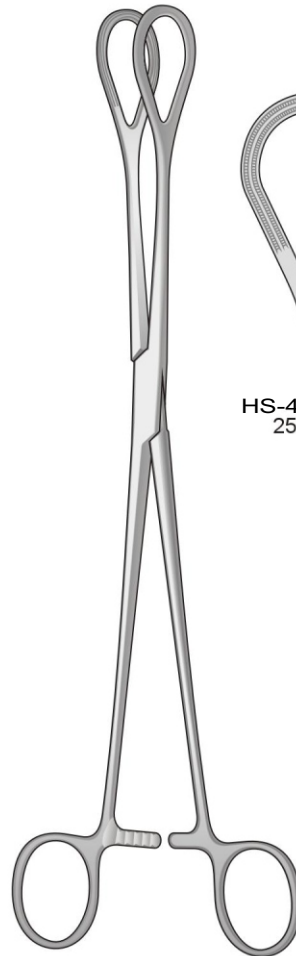

HS-4506

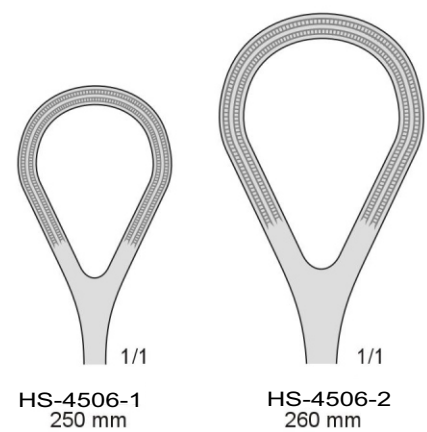

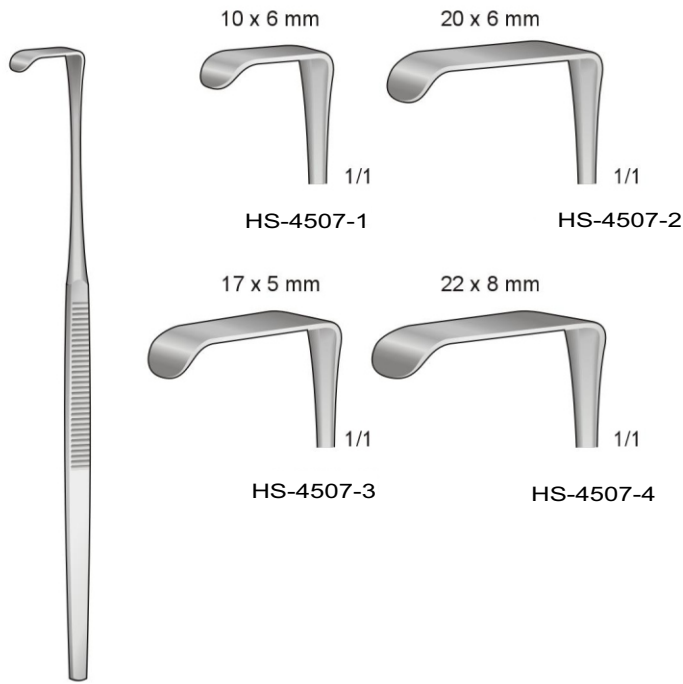

MINI-LANGENBECK  
HS-4507  
160 mm

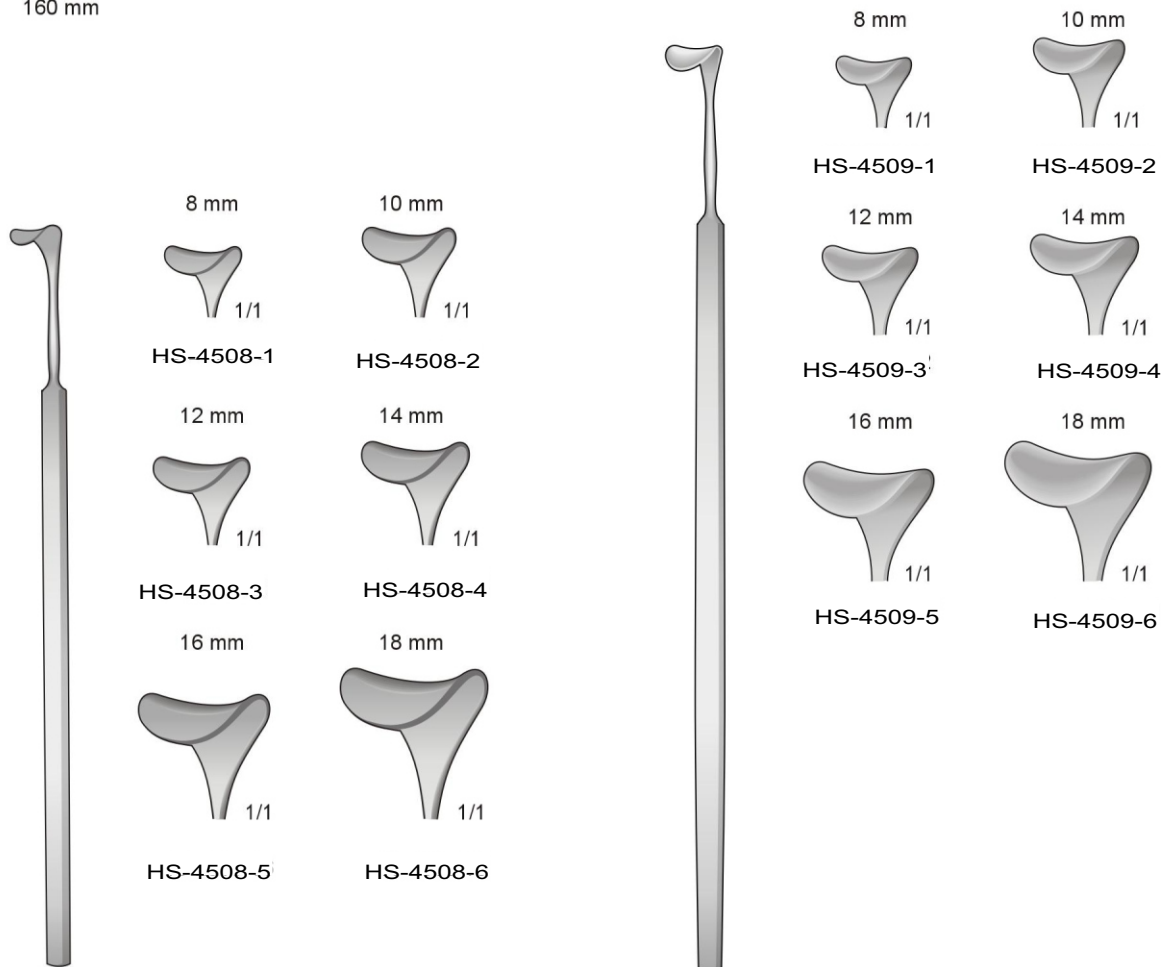

CUSHING  
HS-4508  
200 mm

CUSHING  
HS-4509  
240 mm

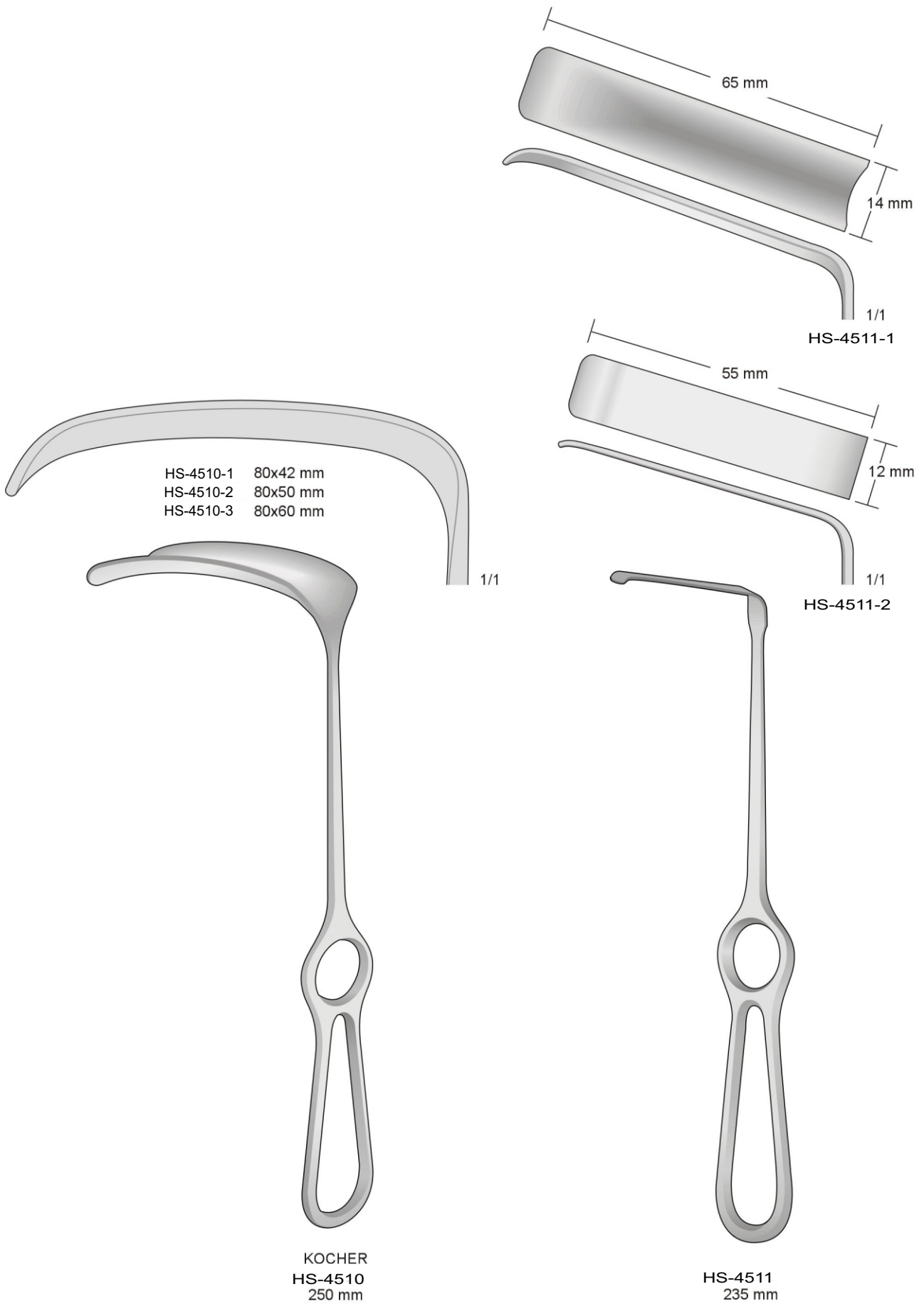

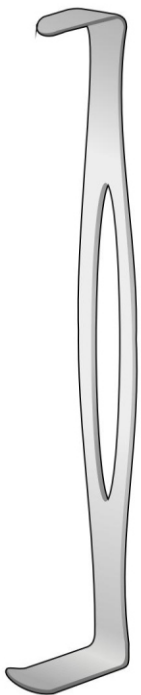
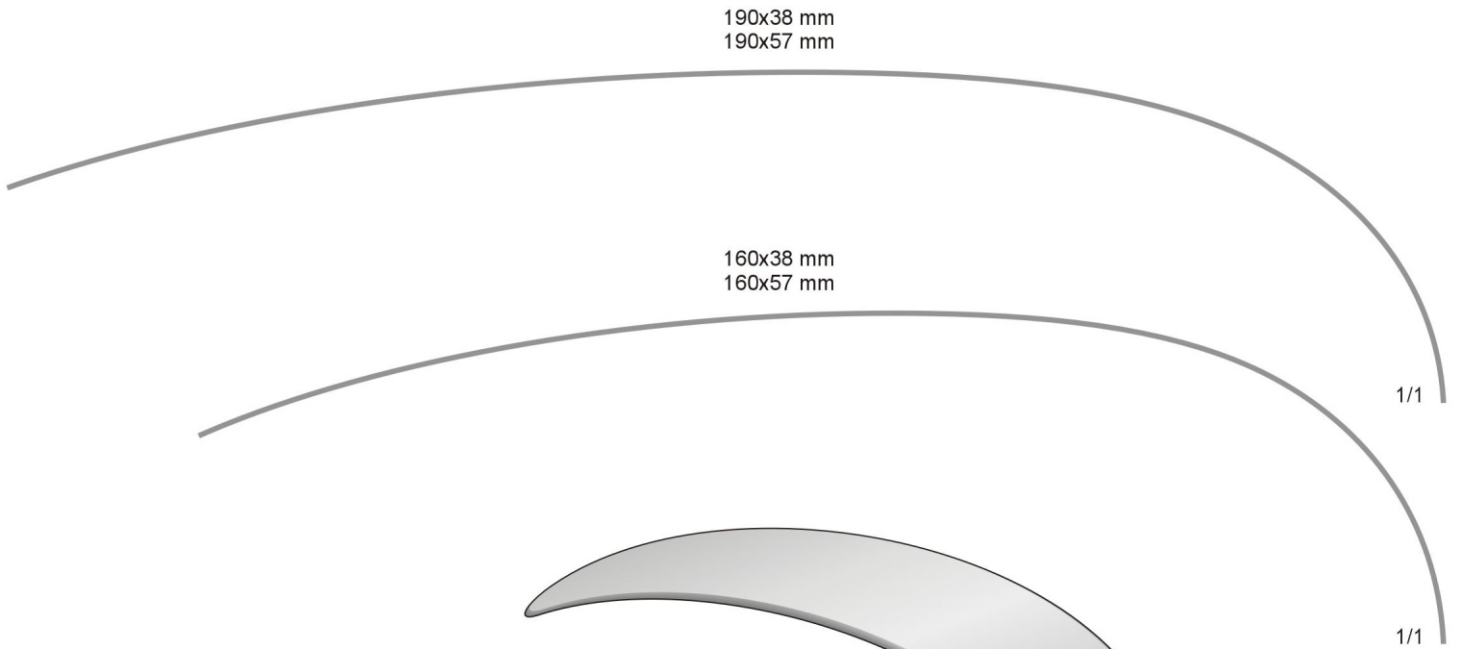

HS-4512-1  
 21 x 24 mm  
 40 x 15 mm

PARKER-LANGENBECK  
 HS-4512  
 210 mm

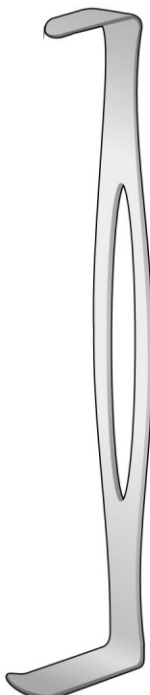

HS-4512-2  
 25 x 24 mm  
 45 x 15 mm

PARKER-LANGENBECK  
 HS-4512  
 210 mm

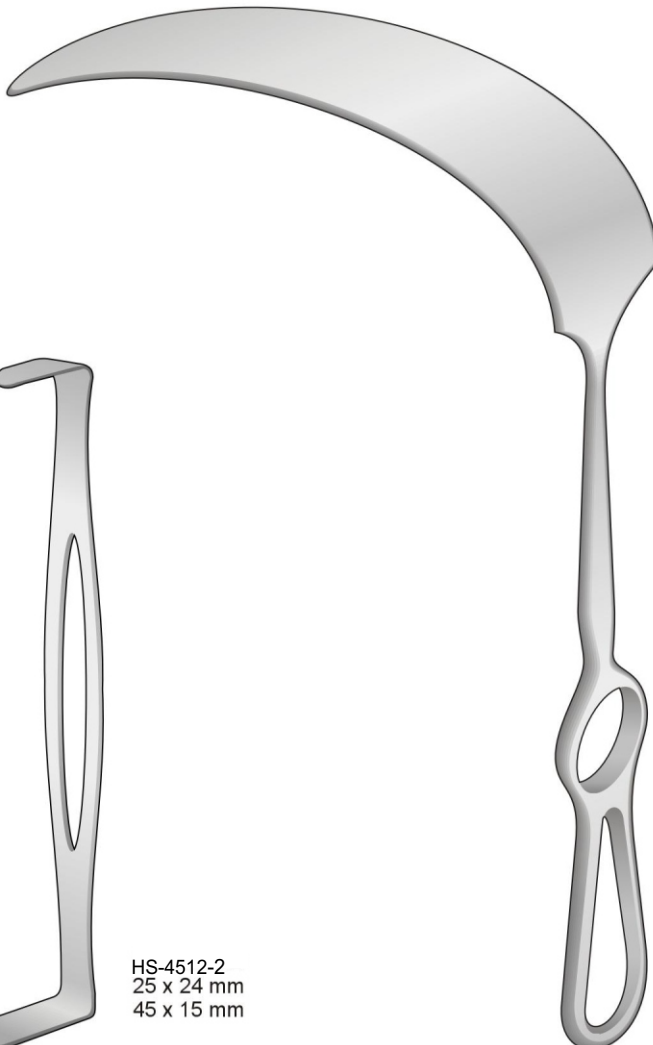

HS-4513-1 160x38 mm  
 HS-4513-2 160x57 mm  
 HS-4513-3 190x38 mm  
 HS-4513-4 190x57 mm

KELLY  
 HS-4513  
 270 mm

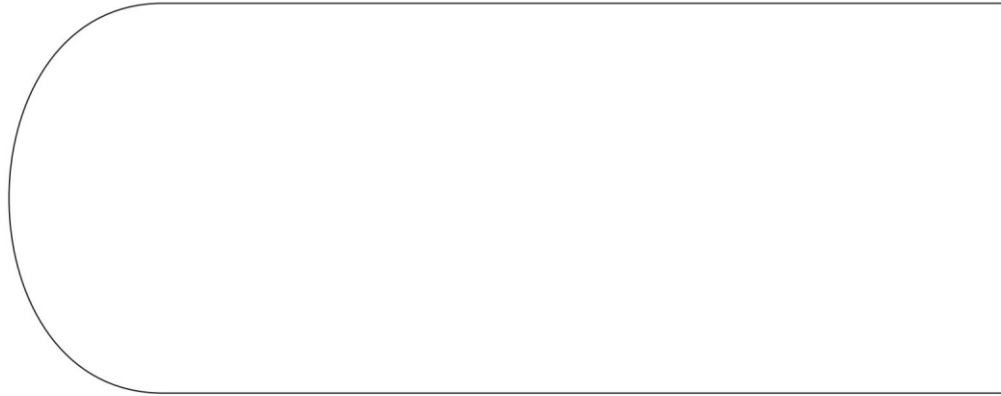

HS-4515-1 147x50 mm

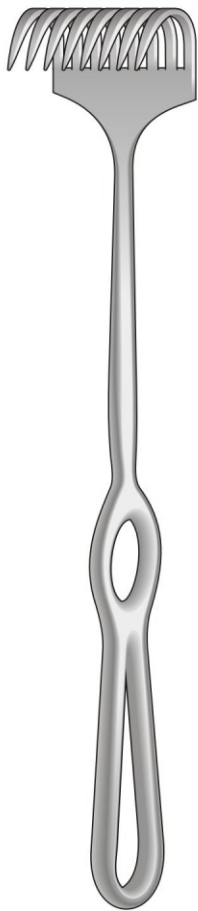

KÖRTE  
HS-4514  
240 mm

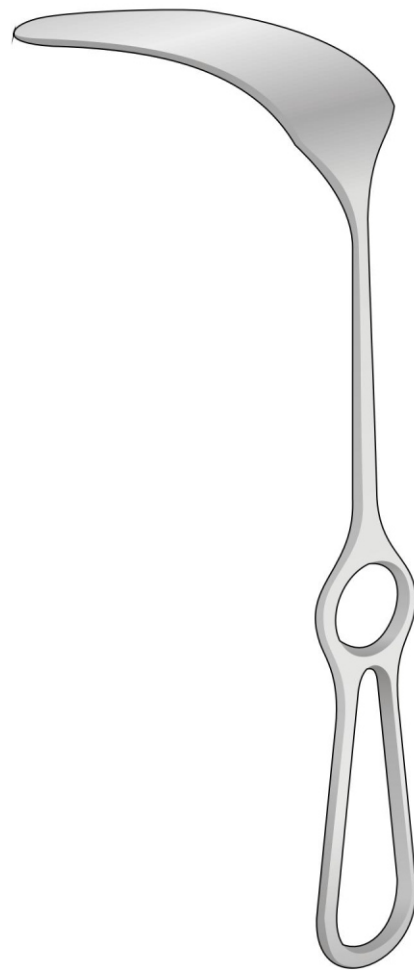
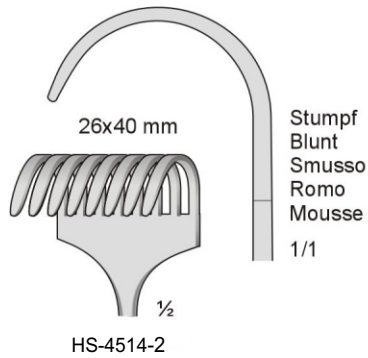
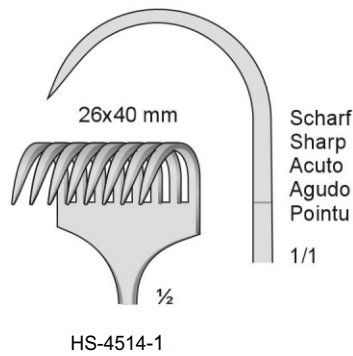

MIKULICZ  
HS-4515  
260 mm

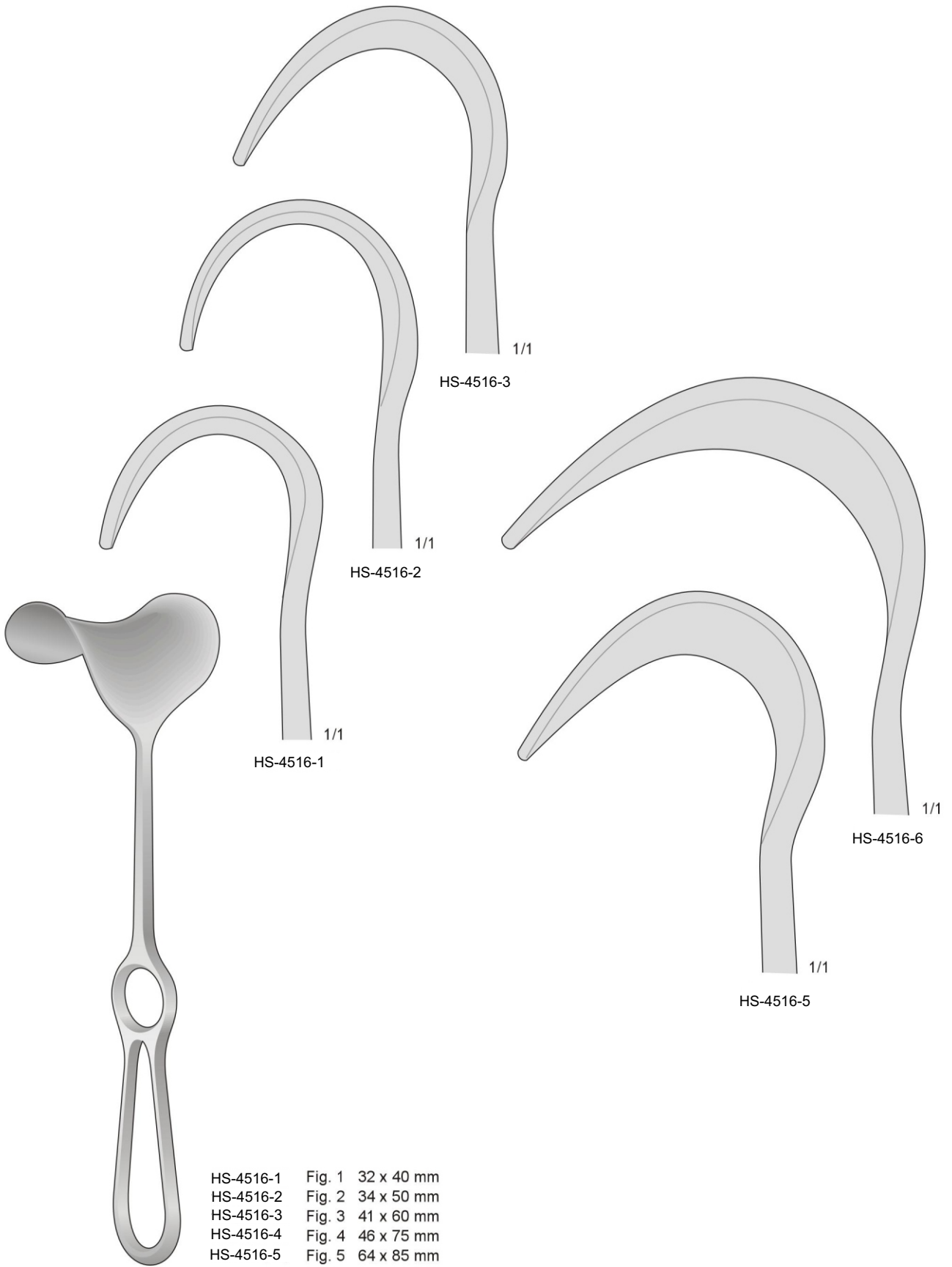

FRITSCH  
HS-4516  
240 mm



Pelvisshaken  
Pelvis retractors

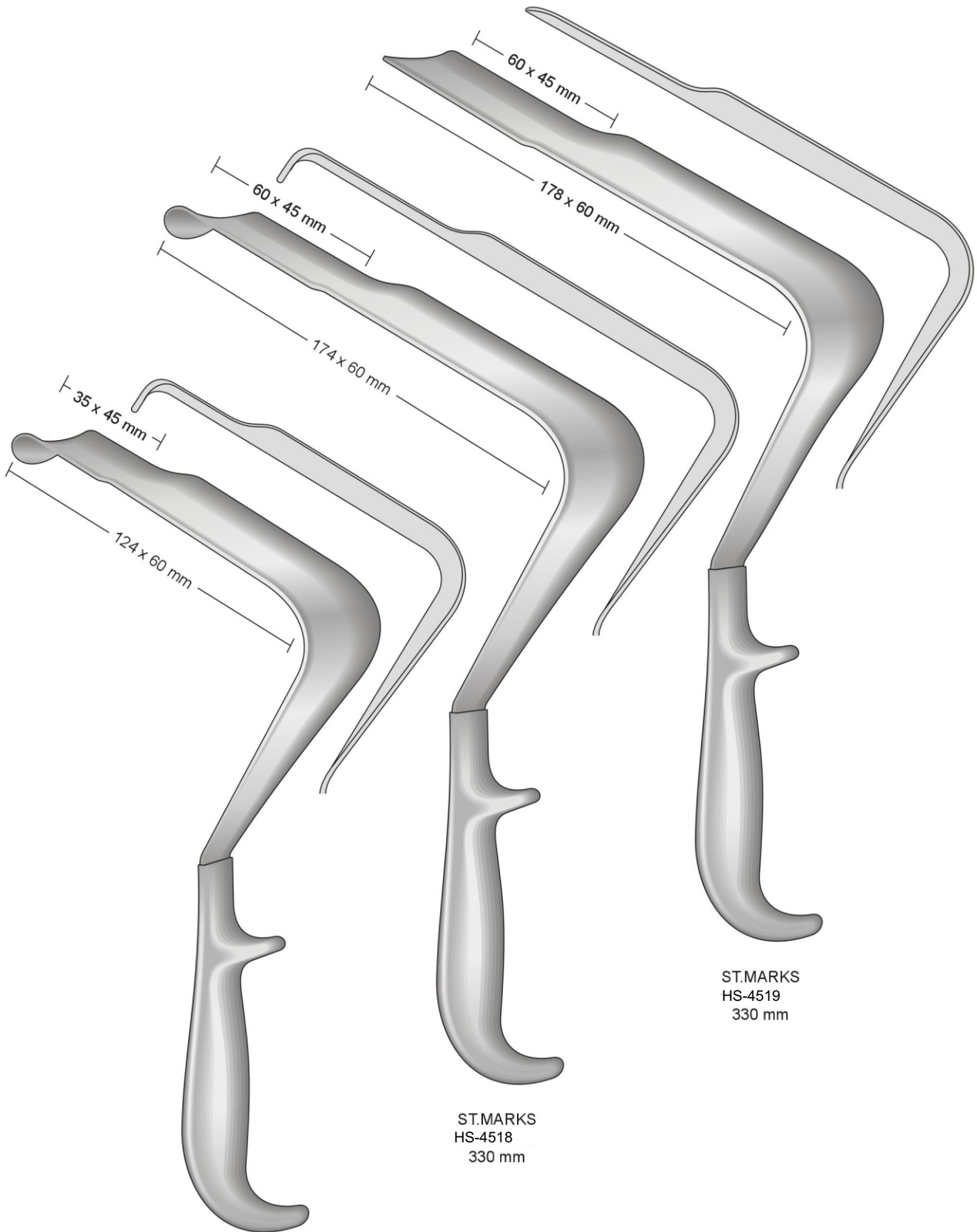

ST.MARKS  
HS-4519  
330 mm

ST.MARKS  
HS-4518  
330 mm

ST.MARKS  
HS-4517  
290 mm

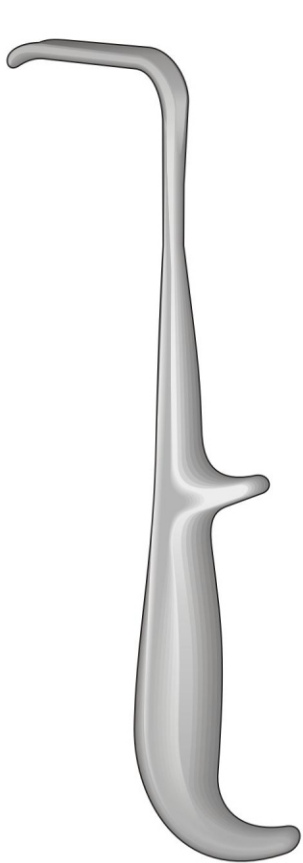
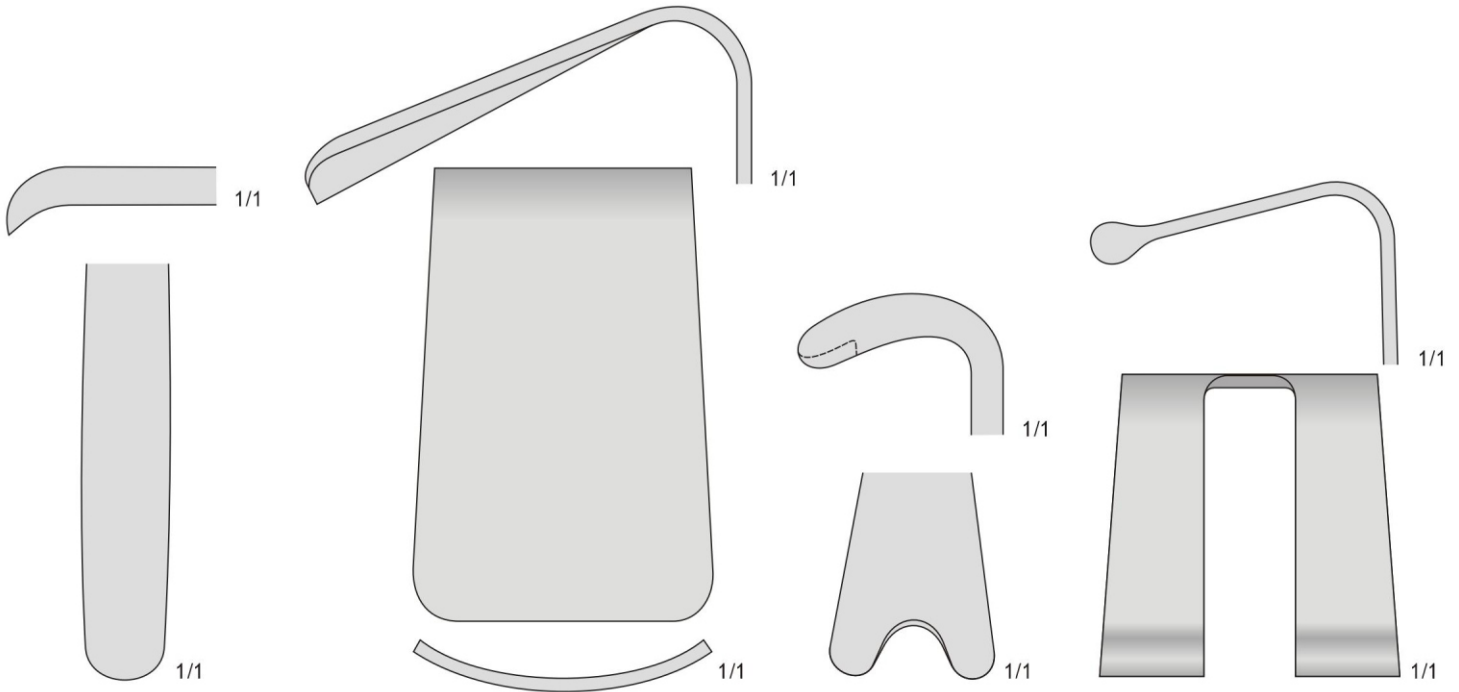

YOUNG  
 HS-4520  
 215 mm

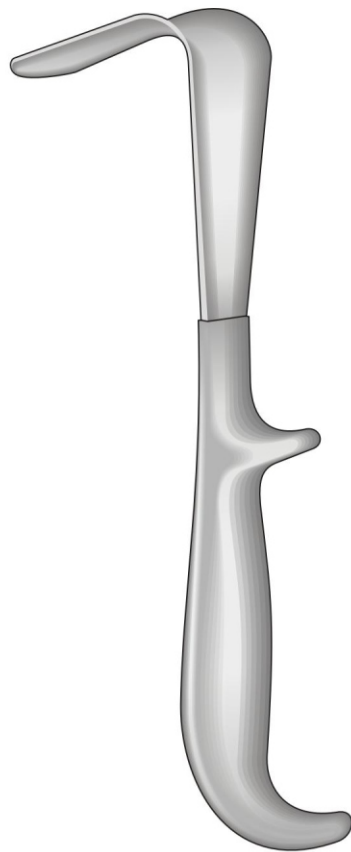

YOUNG  
 HS-4521  
 210 mm

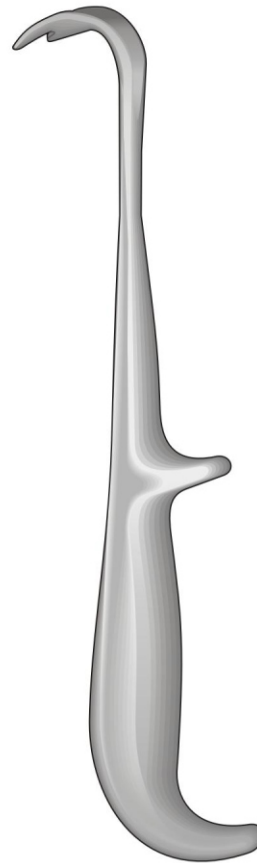

YOUNG  
 HS-4522  
 220 mm

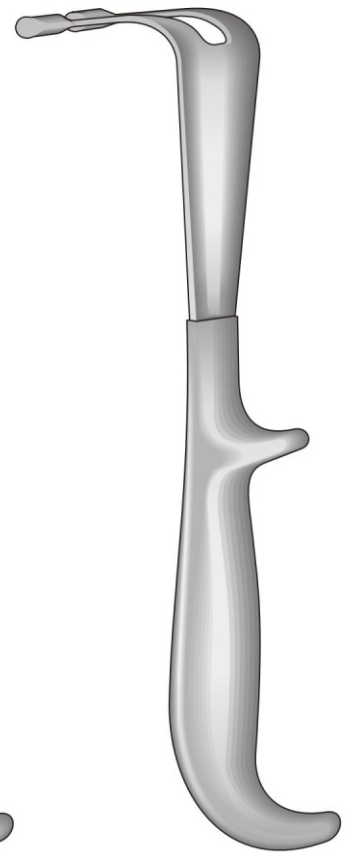

YOUNG  
 HS-4523  
 210 mm

new

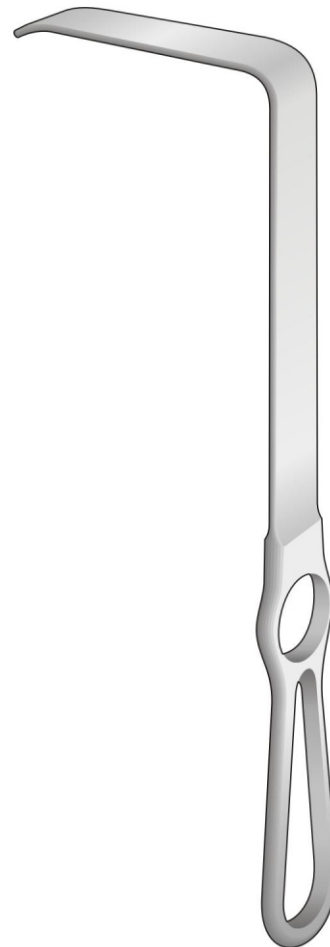
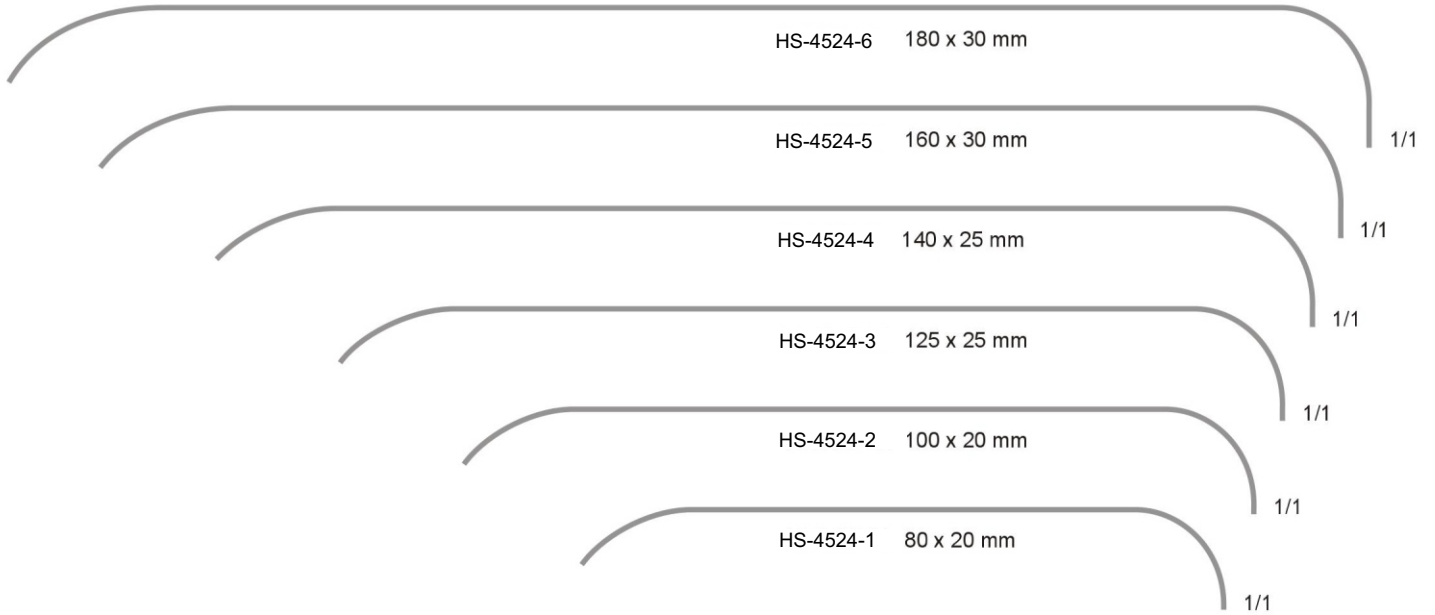

BRUNNER  
HS-4524  
250 mm

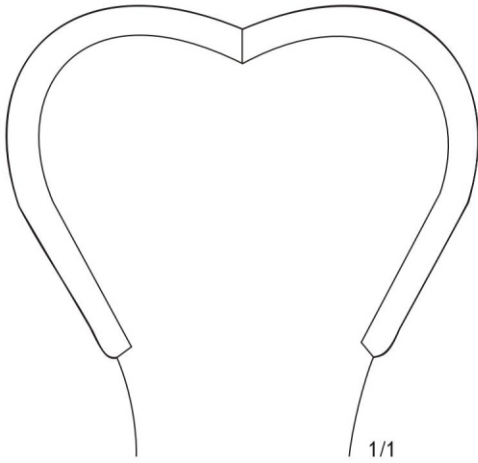

HARRINGTON-PEMBERTON  
HS-4525 175 x 64 mm  
295 mm

← 137 mm →

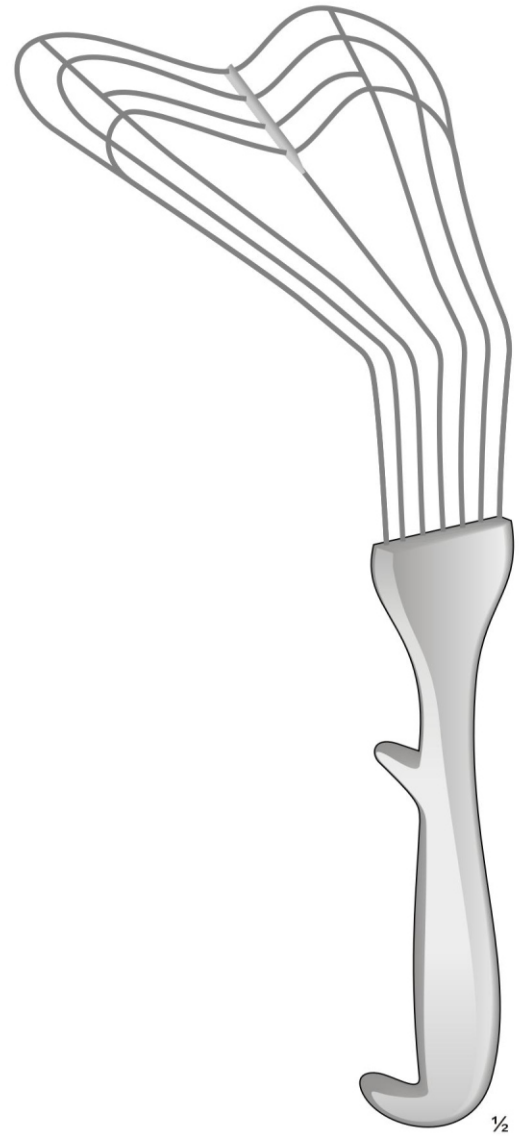

HS-4526  
300 mm

Gefäßclips - Vessel Clips  
Clamps vascolari - Clamps vasculares  
Clamps vasculaires

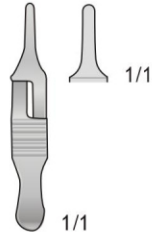

DIEFFENBACH  
HS-4527  
30 mm

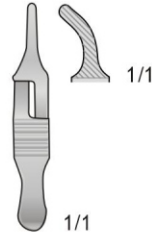

DIEFFENBACH  
HS-4528  
30 mm

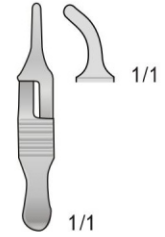

DIEFFENBACH  
HS-4529  
30 mm

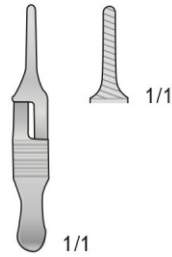

DIEFFENBACH  
HS-4530  
30 mm

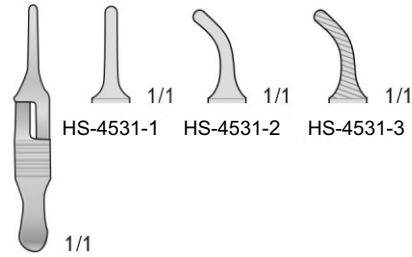

DIEFFENBACH  
HS-4531  
35 mm

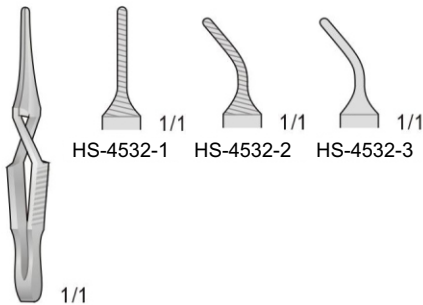

HS-4532  
40 mm

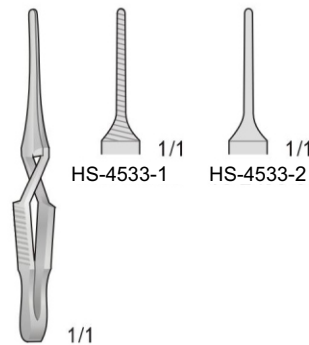

HS-4533  
45 mm

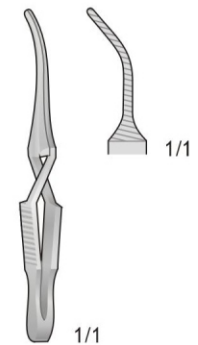

45 mm

**Comedo Extractors**

Komplettsset mit 3 Haken Stripper - Set complete with 3 Vein Stripper  
Set completo con 3 uncini per vene - Set completo con 3 sondas para verices  
Set complete avec 3 stripper a anneau

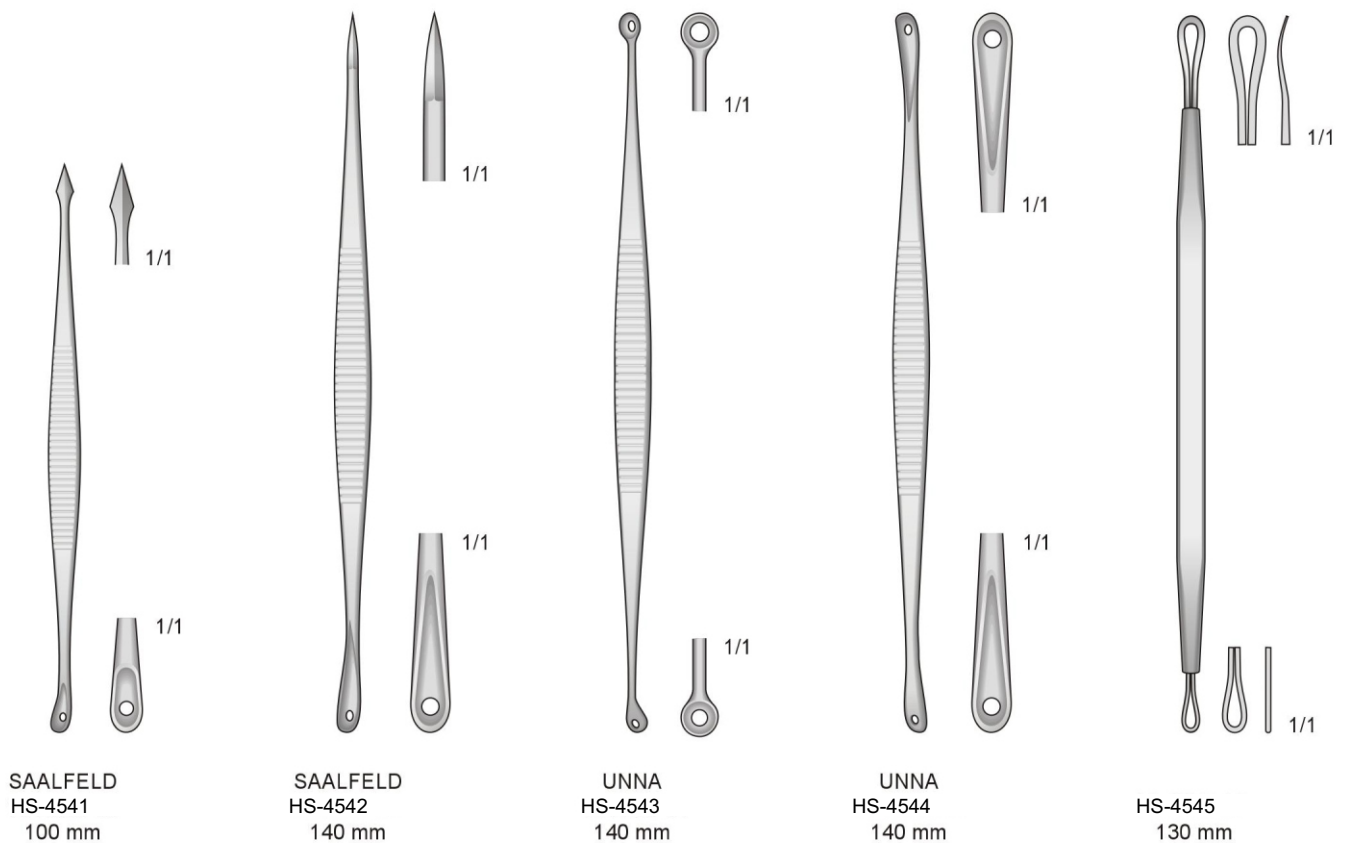
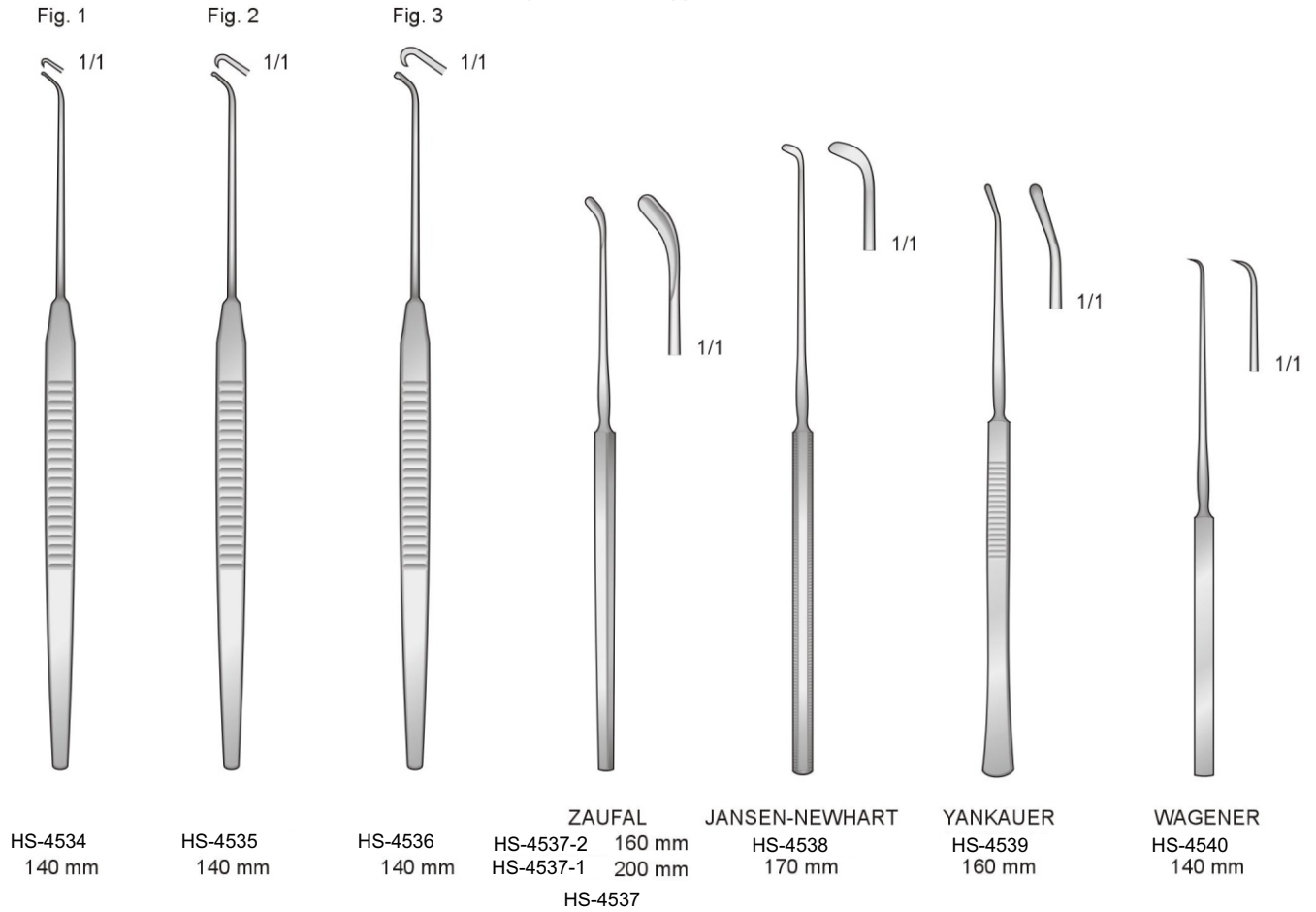



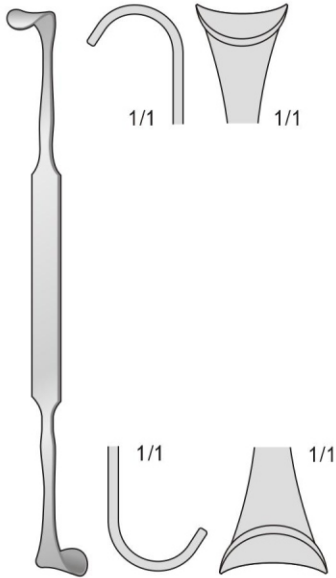

ROSE  
HS-4546  
130 mm

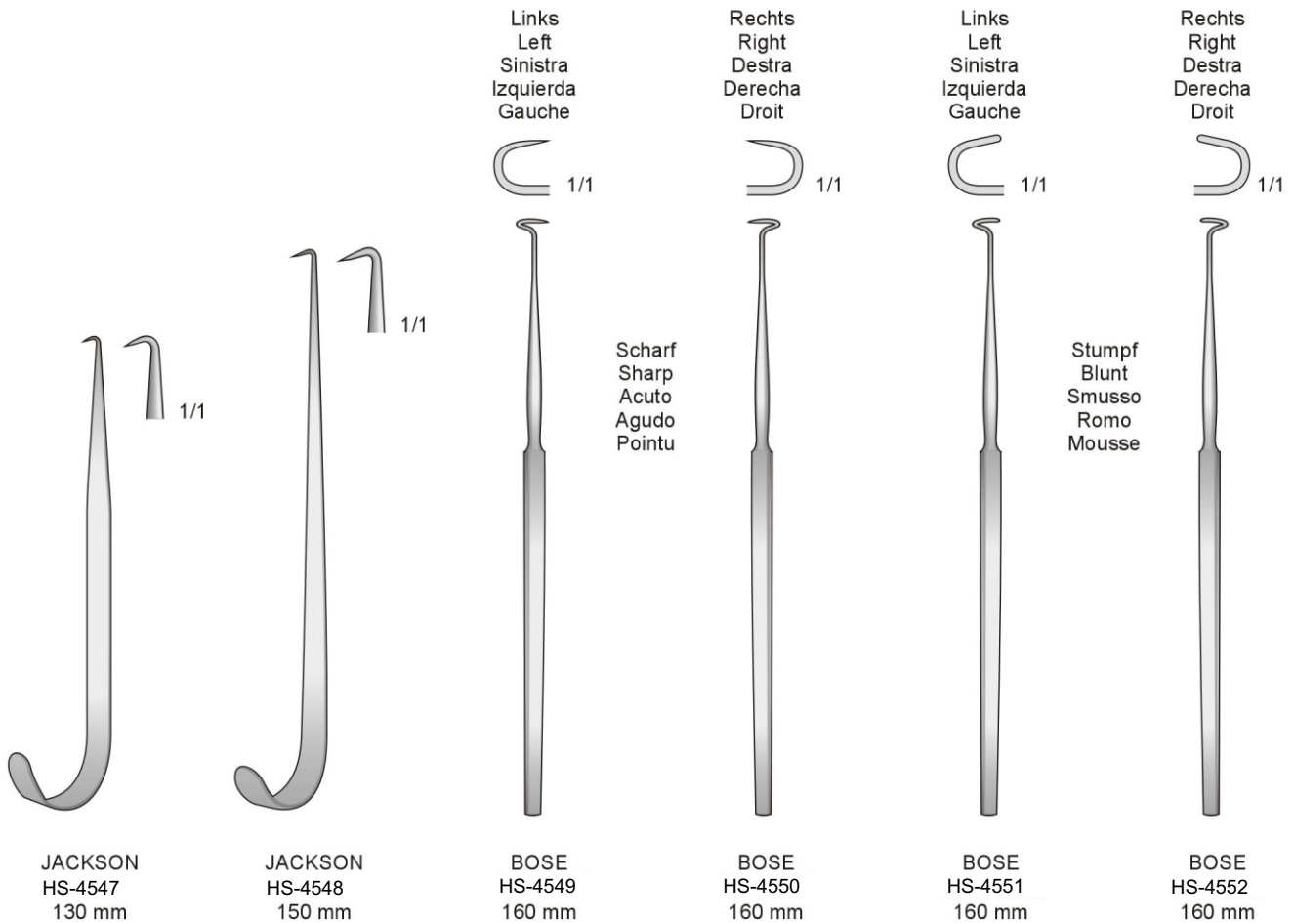

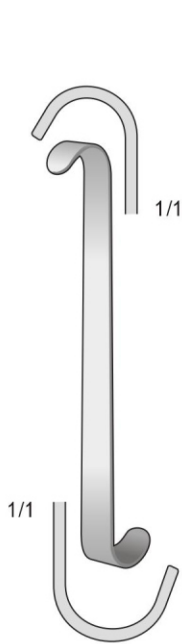

LUER  
HS-4553  
110 mm

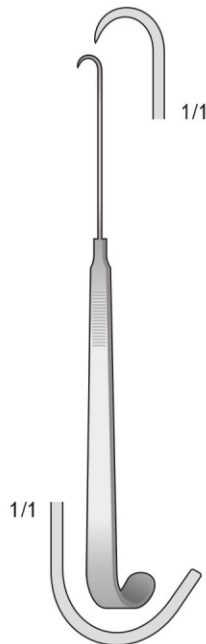

NEWS  
HS-4554  
150 mm

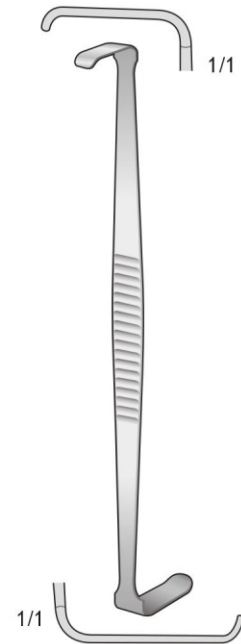

HOUSE  
HS-4555  
150 mm

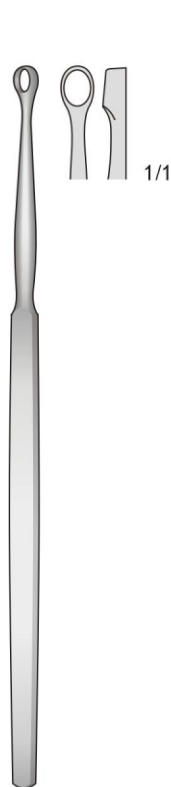

FOX  
HS-4556  
140 mm



WOLF  
HS-4557  
140 mm

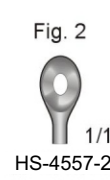
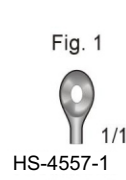

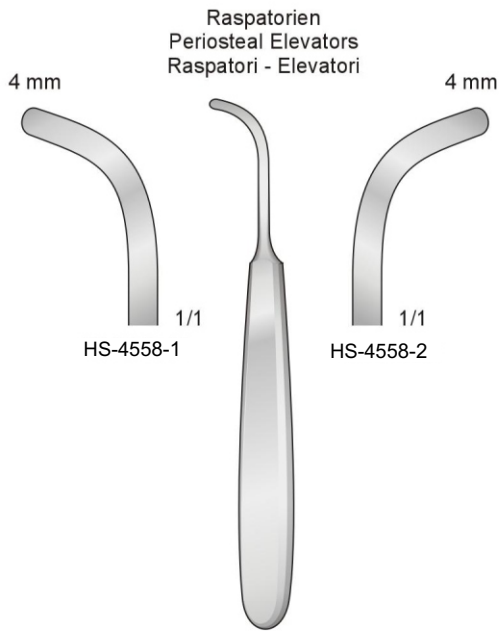

HS-4558  
140 mm

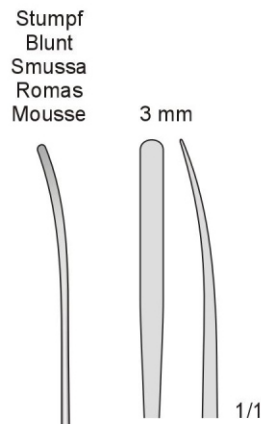
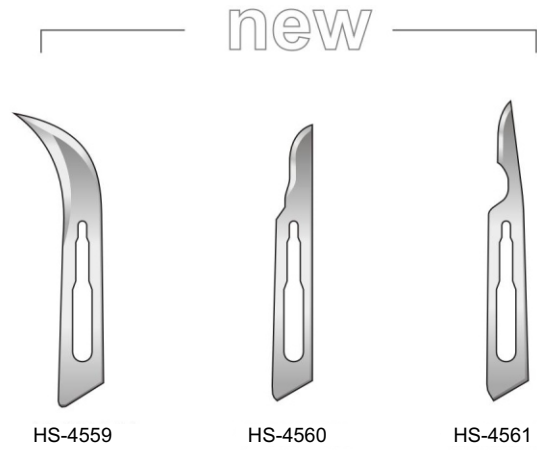

HS-4565  
180 mm

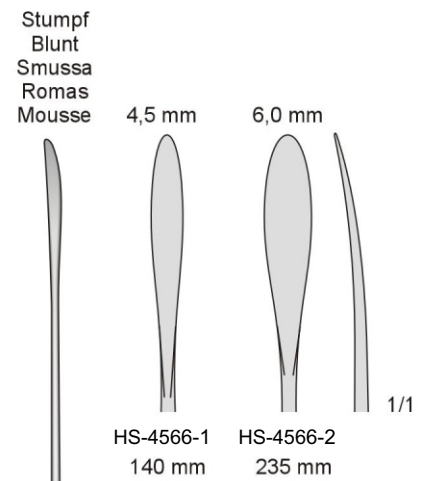

HS-4566



HS-4562  
100 mm



HS-4563  
130 mm



HS-4564  
150 mm

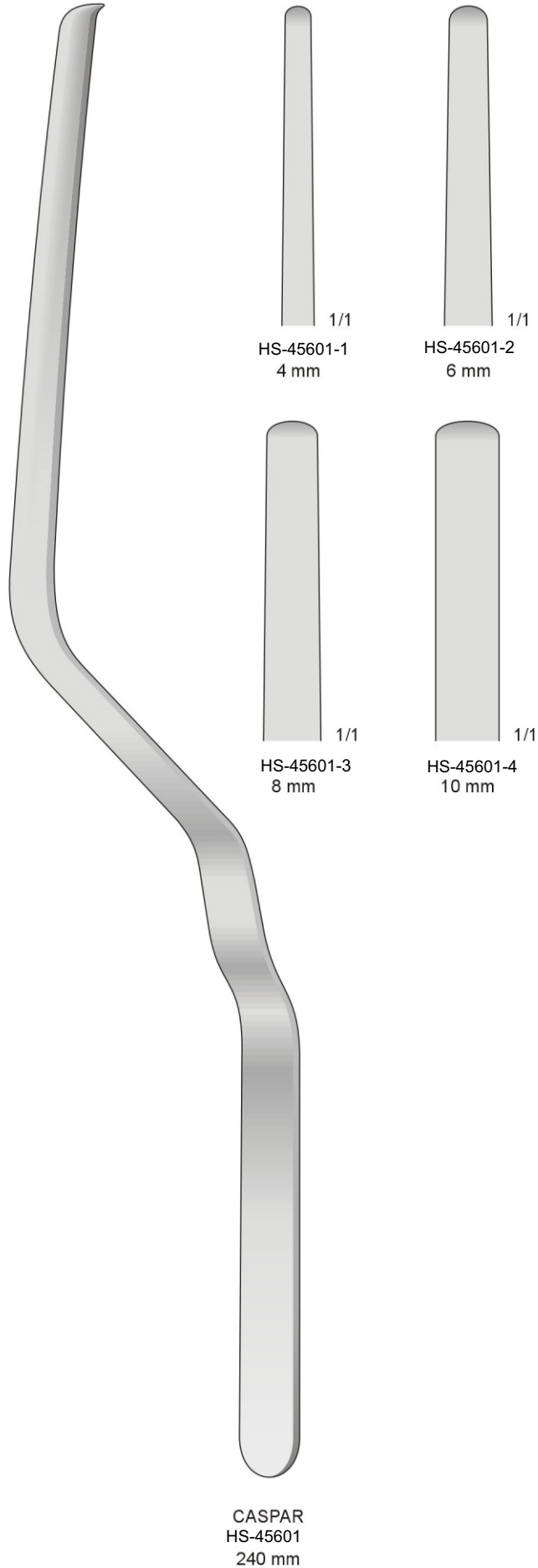



Femur-Wundspreizer für kinder  
Femur Retractor for children  
Divaricatore femorale per bambini

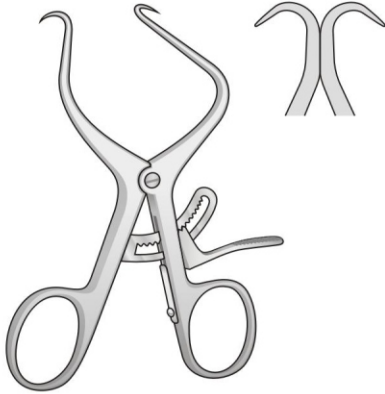

DE BAKEY  
HS-45602  
100 mm

Femur-Wundspreizer  
Femur Retractor  
Divaricatore femorale

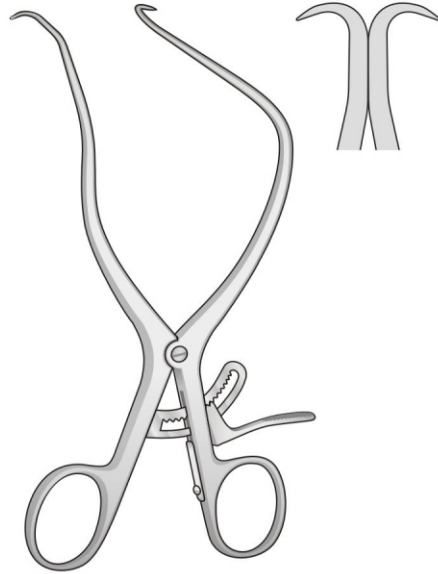

DE BAKEY  
HS-45603  
170 mm

Wundspreizer  
Retractors for shoulder  
Divaricatori da spalla  
Separadores  
Ecarteurs

Stumpf - Blunt  
Smusso - Romo  
Mousse

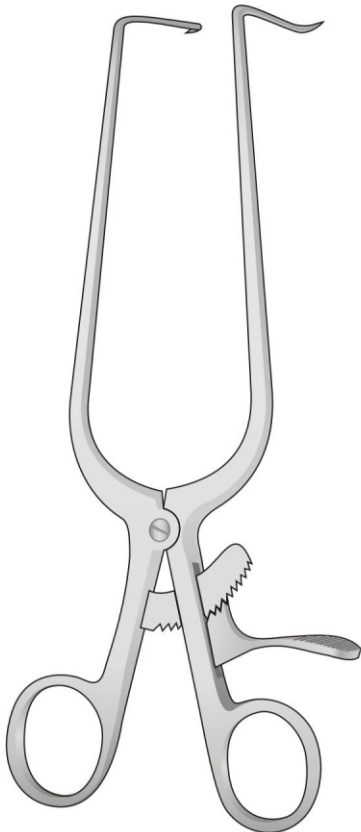

HS-45604  
215 mm

Stumpf - Blunt  
Smusso - Romo  
Mousse

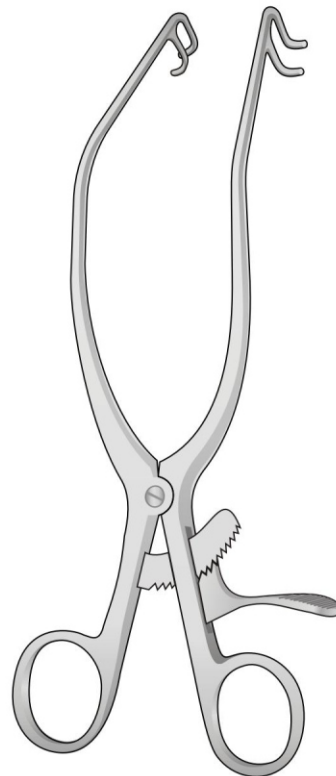

KÖLBEL  
HS-45605  
180 mm

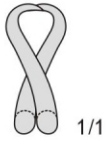

1/1

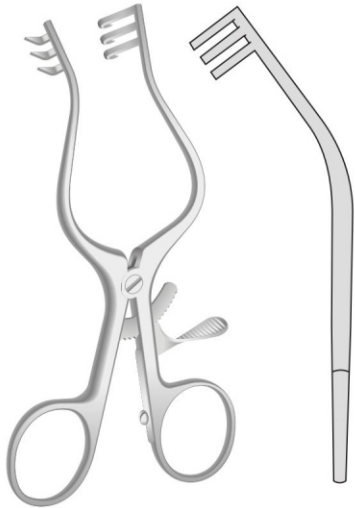

Scharf  
 Sharp  
 Acuto  
 Agudo  
 Pointu

WULLSTEIN  
 HS-4569  
 130 mm



1/1

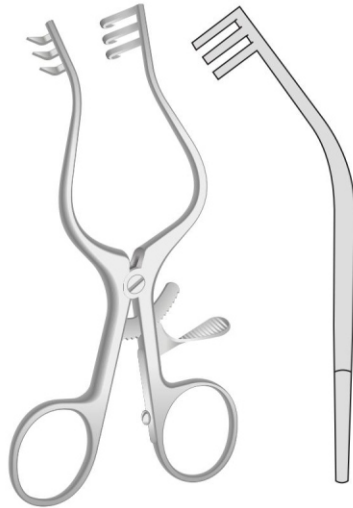

Stumpf  
 Blunt  
 Smusso  
 Romo  
 Mousse

WULLSTEIN  
 HS-4570  
 130 mm

Scharf  
 Sharp  
 Acuto  
 Agudo  
 Pointu

Stumpf  
 Blunt  
 Smusso  
 Romo  
 Mousse

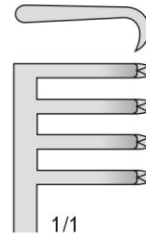

1/1

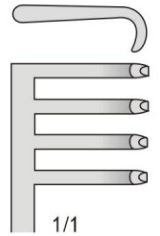

1/1

HS-4568-1

HS-4568-2



1/1

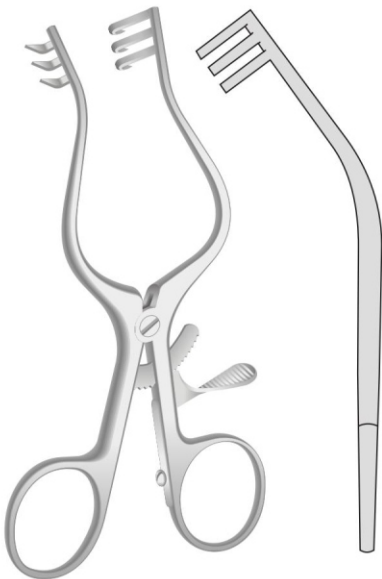

Scharf  
 Sharp  
 Acuto  
 Agudo  
 Pointu

WULLSTEIN  
 HS-4566  
 160 mm



1/1

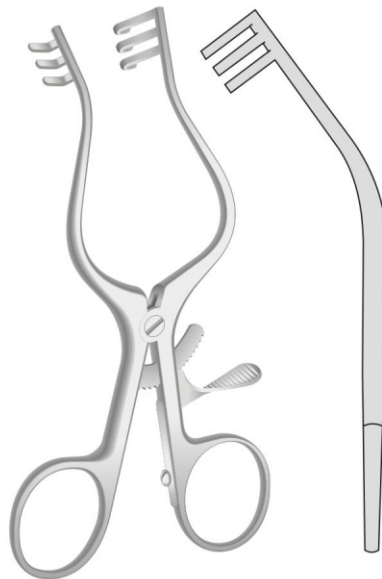

Stumpf  
 Blunt  
 Smusso  
 Romo  
 Mousse

WULLSTEIN  
 HS-4567  
 160 mm



SCALP-CONTOUR  
 HS-4568  
 135 mm



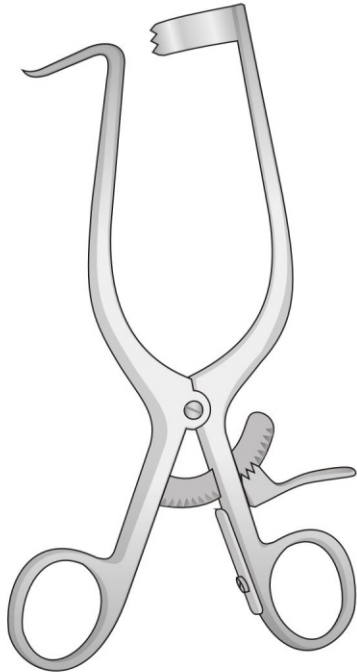

WILLIAMS  
 HS-4572  
 170 mm

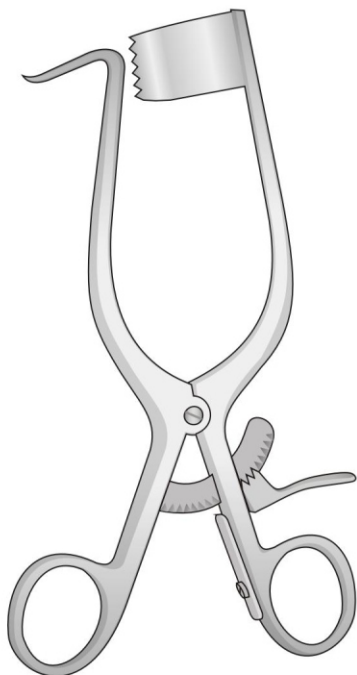
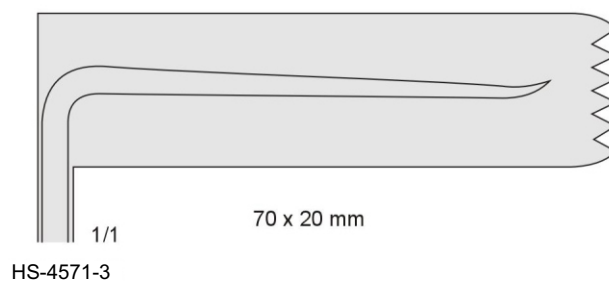
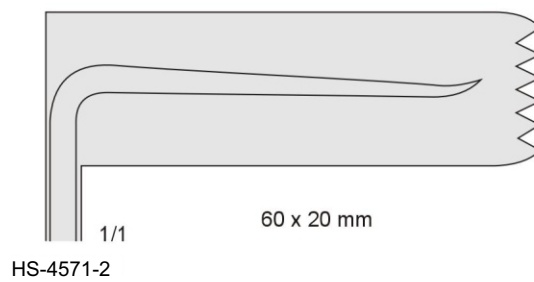
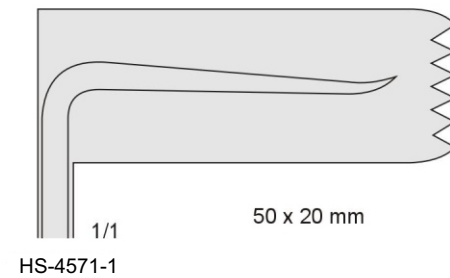
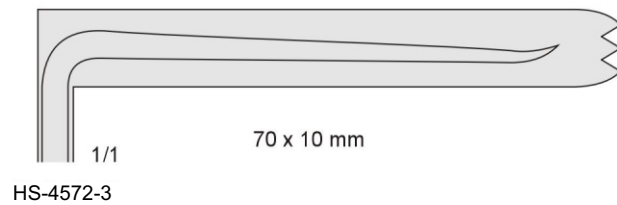
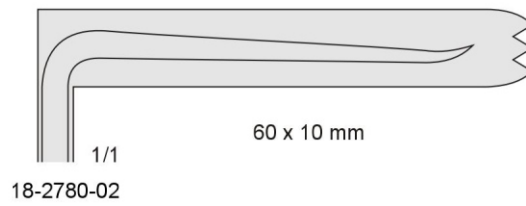
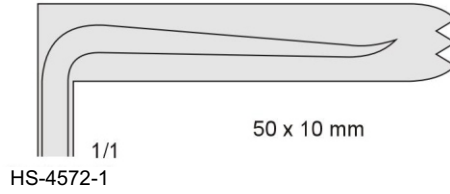

WILLIAMS  
 HS-4571  
 170 mm

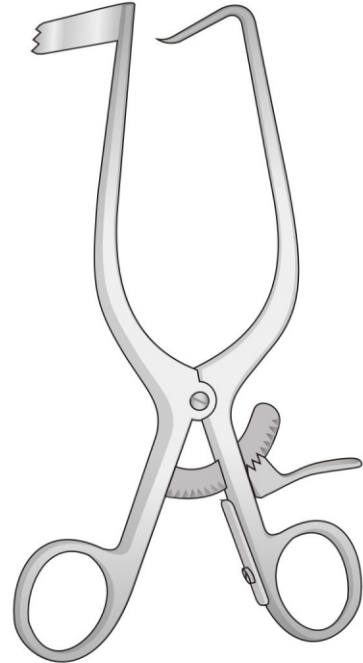
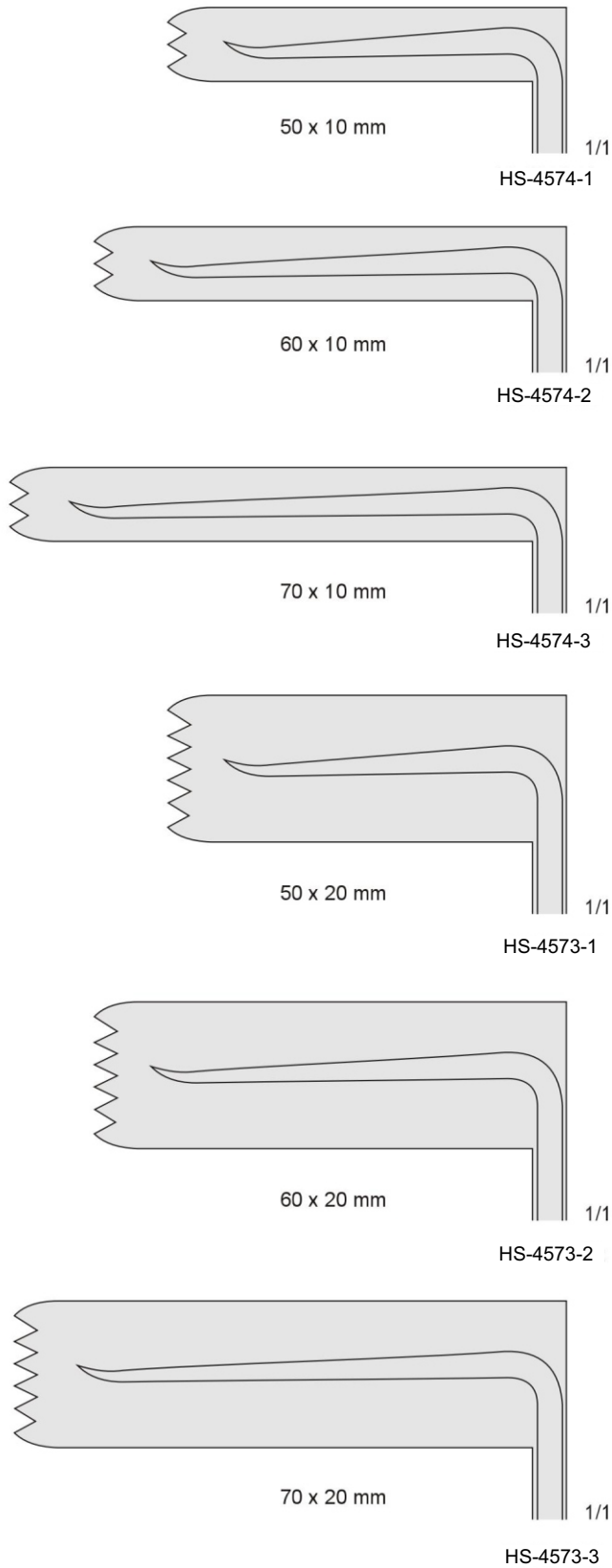

WILLIAMS  
 HS-4574  
 170 mm

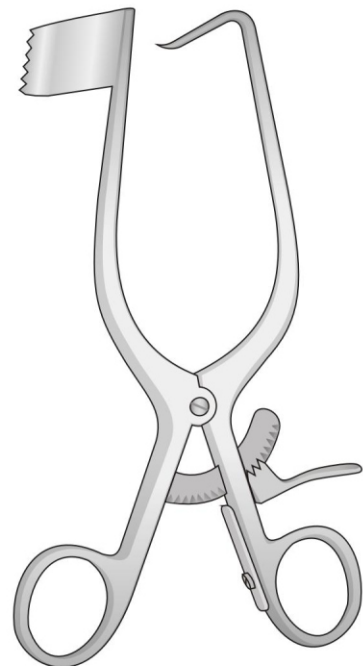

WILLIAMS  
 HS-4573  
 170 mm

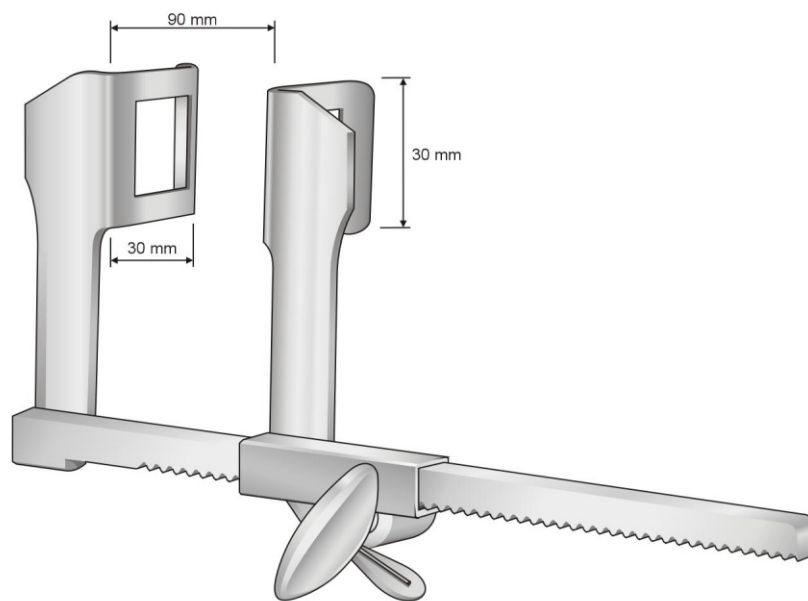

HAIGHT  
HS-4575

CASPAR  
HS-4578  
Distraktor komplett rechts  
Distractor complete right  
Distrattore completo destro  
HS-4578-1 Distraktor allein - 1 Distractor only  
HS-4578-2 Bohrbüchse - 1 Drilling Guide  
HS-4578-3 Spezialbohrer - 1 Special Drill  
HS-4578-4 ! Distraktionsschrauben - 2 Distraction Screws  
HS-4578-5 Schraubendreher - 1 Screw Driver

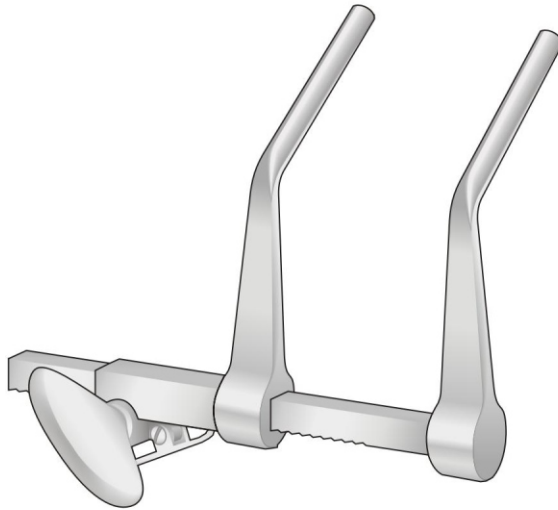

CASPAR  
HS-4578  
Distraktor rechts, Allein  
Distractor right, Only  
Distrattore destro, solo

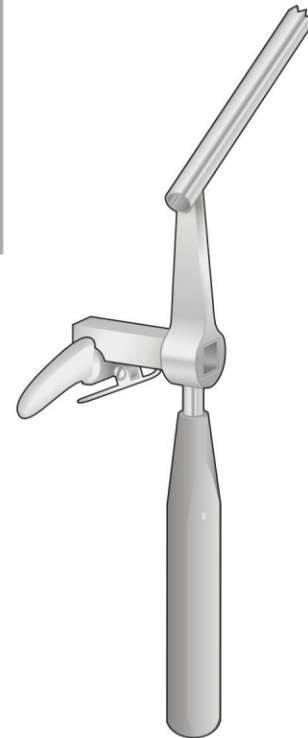

HS-4579  
Bohrbüchse rechts, Allein  
Drilling Guide right, Only  
Guida punte destro, solo

CASPAR  
HS-4576  
Distraktor komplett links  
Distractor complete left  
Distrattore completo sinistro  
HS-4576-1 Distraktor allein - 1 Distractor only  
HS-4576-2 Bohrbüchse - 1 Drilling Guide  
HS-4576-3 Spezialbohrer - 1 Special Drill  
HS-4576-4 ! Distraktionsschrauben - 2 Distraction Screws  
HS-4576-5 Schraubendreher - 1 Screw Driver

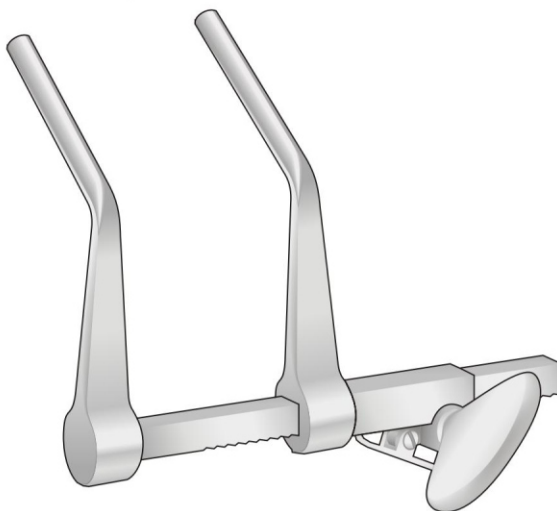

CASPAR  
HS-4576  
Distraktor links, Allein  
Distractor left, Only  
Distrattore sinistro, solo

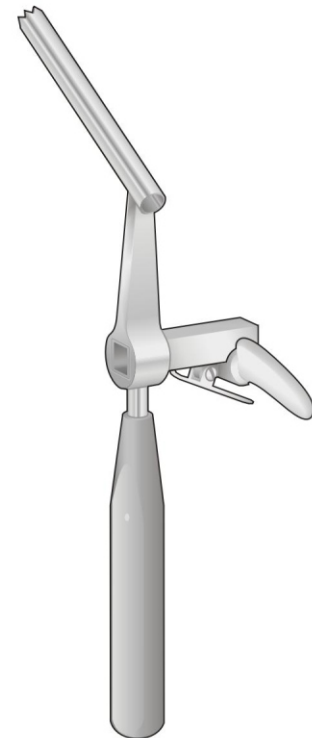

HS-4577  
Bohrbüchse links, Allein  
Drilling Guide left, Only  
Guida punte sinistro, solo

Screw Driver  
Schraubendreher



CASPAR  
HS-4582  
200 mm

Special Drill  
Spezialbohrer  
Ø 1,7 mm

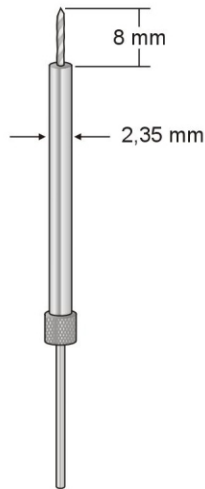

CASPAR  
HS-4583  
145 mm

Distraction Screw  
Distractionsschrauben

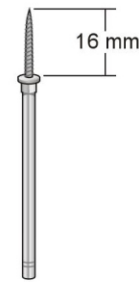

CASPAR  
HS-4584  
70 mm

CASPAR

Distraktor komplett links  
Distractor complete left  
Distrattore completo sinistro

- 1 Distraktor allein - 1 Distractor only
- 1 Bohrbüchse - 1 Drilling Guide
- 1 Spezialbohrer - 1 Special Drill
- 2 Distractionsschrauben - 2 Distraction Screws
- 1 Schraubendreher - 1 Screw Driver

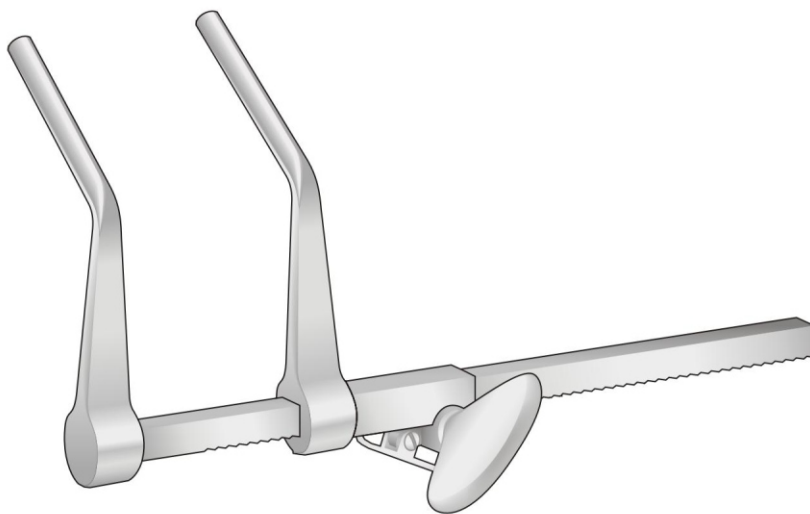

CASPAR  
HS-4580  
Distraktor links, Allein  
Distractor left, Only  
Distrattore sinistro, solo

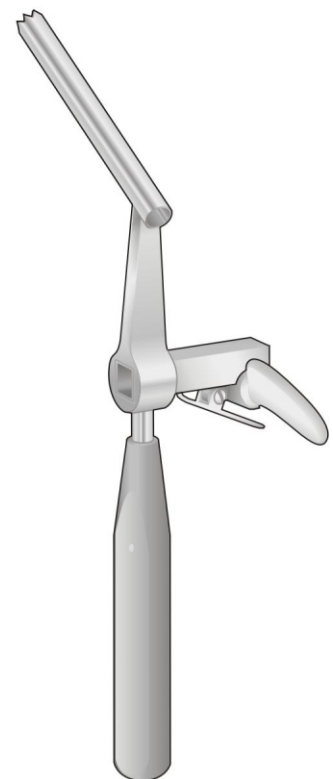

HS-4581  
Bohrbüchse links, Allein  
Drilling Guide left, Only  
Guida punte sinistro, solo

Special Drill  
 Spezialbohrer  
 Ø 1,7 mm

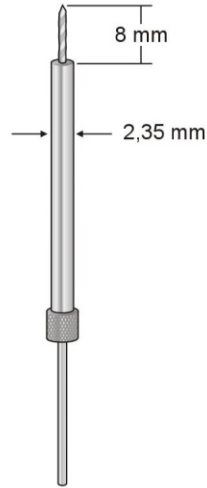

CASPAR  
 HS-4586  
 145 mm

Distraction Screw  
 Distraktionsschrauben

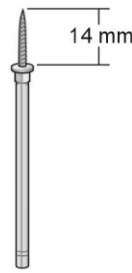

CASPAR  
 HS-4587  
 70 mm

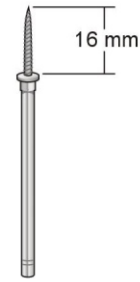

CASPAR  
 HS-4588  
 70 mm

Screw Driver  
 Schraubendreher



CASPAR  
 HS-4585  
 200 mm



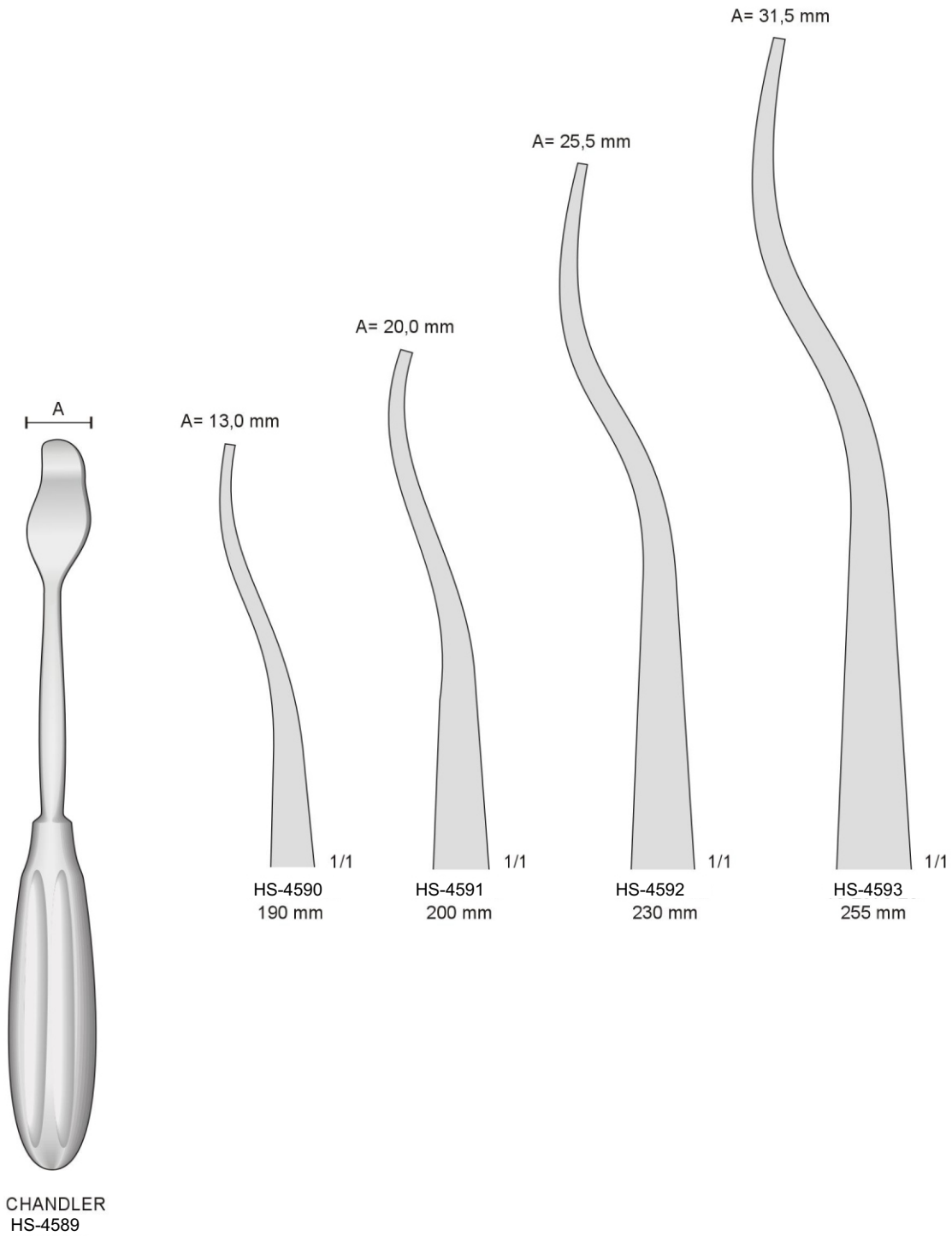

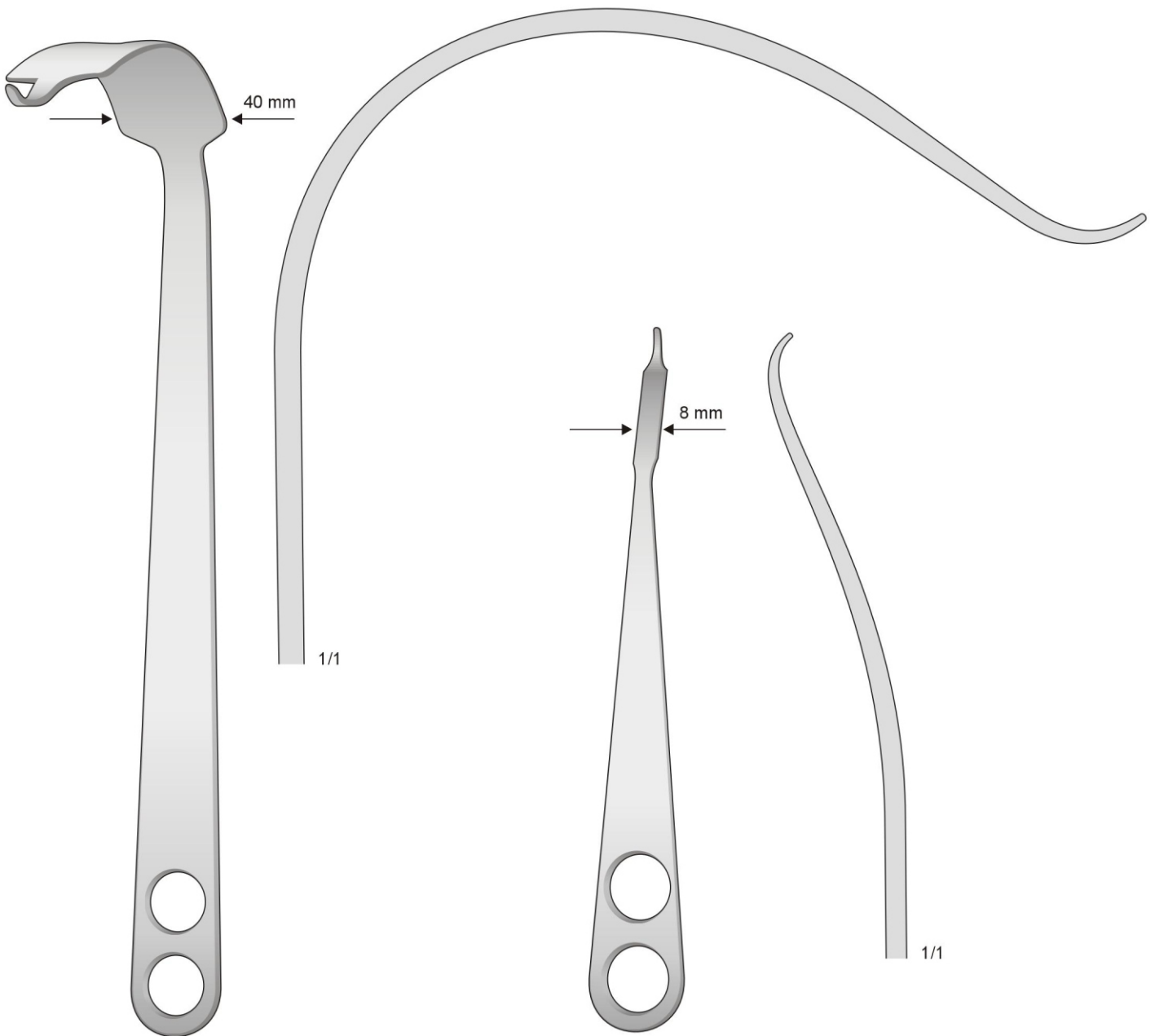

HOHMANN  
HS-4594  
330 mm

HOHMANN  
HS-4595  
225 mm

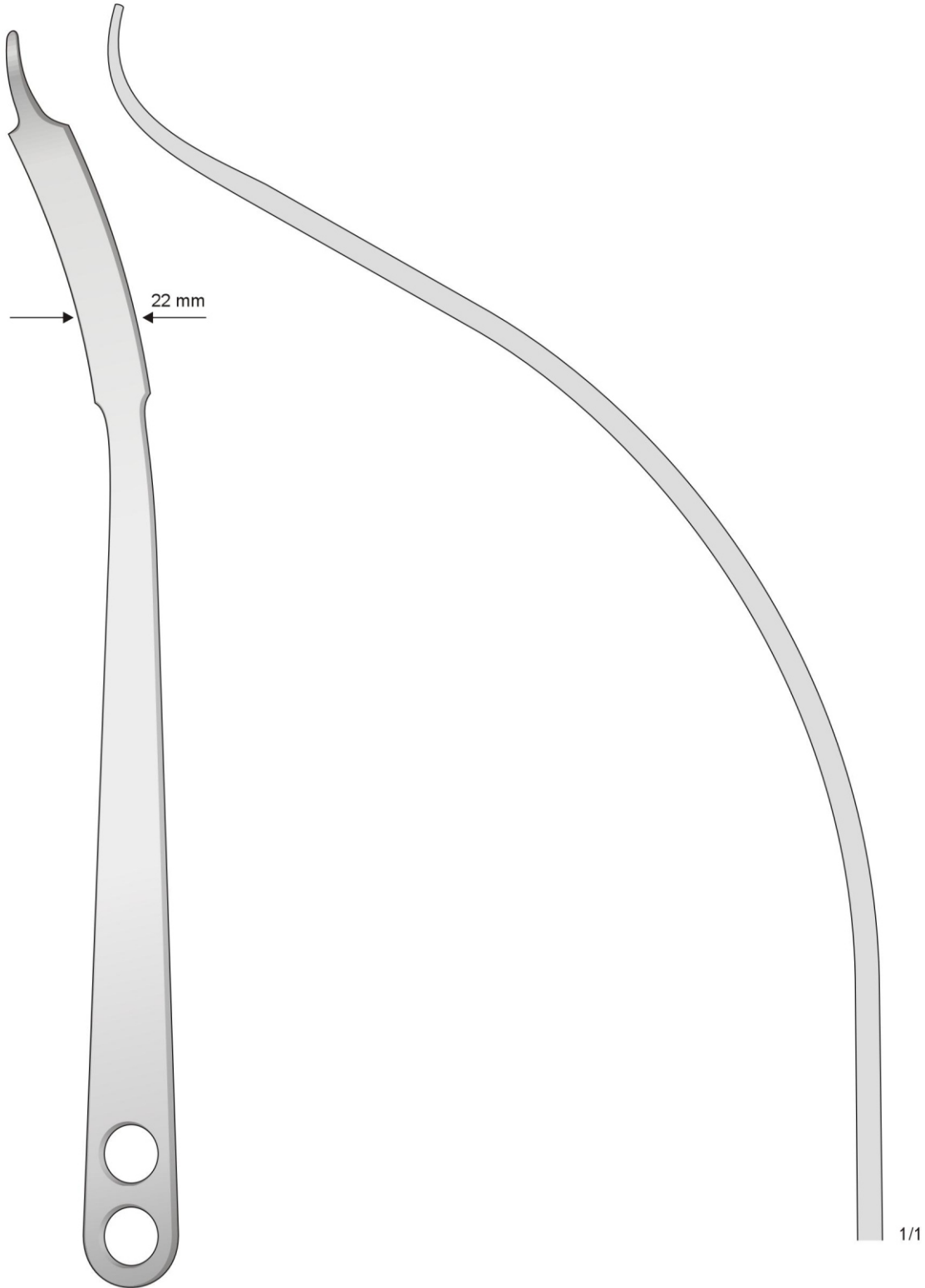

HOHMANN  
HS-4596  
400 mm

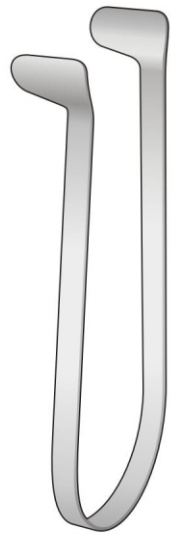

THUDICUM  
HS-4600

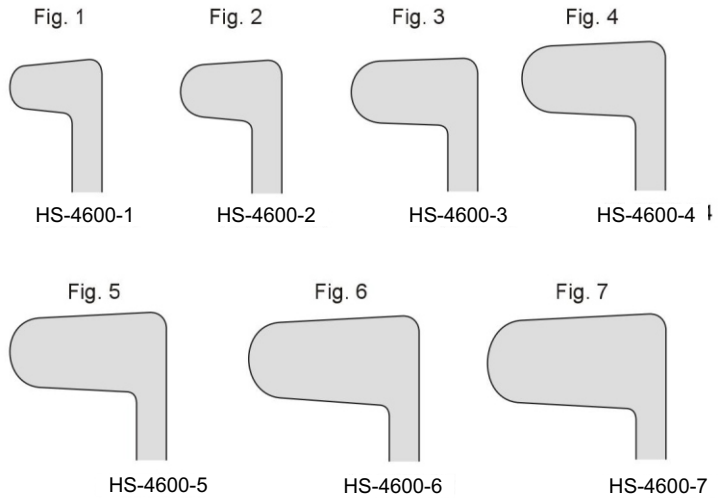

**Zungenspatel - Tongue Depressor**  
**Adenotomie - Tonsillektomie**

10 x 13 mm

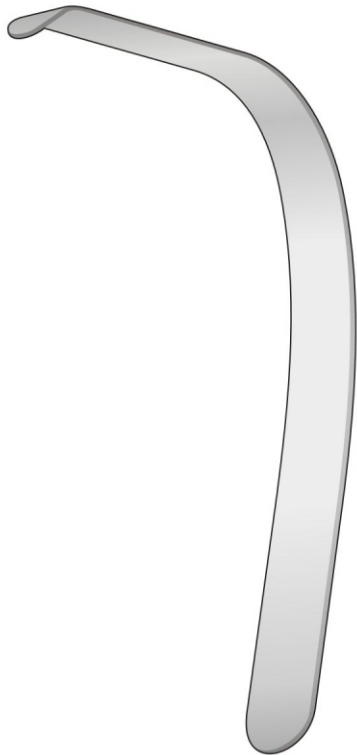

LACK  
HS-4597

13 x 19 mm

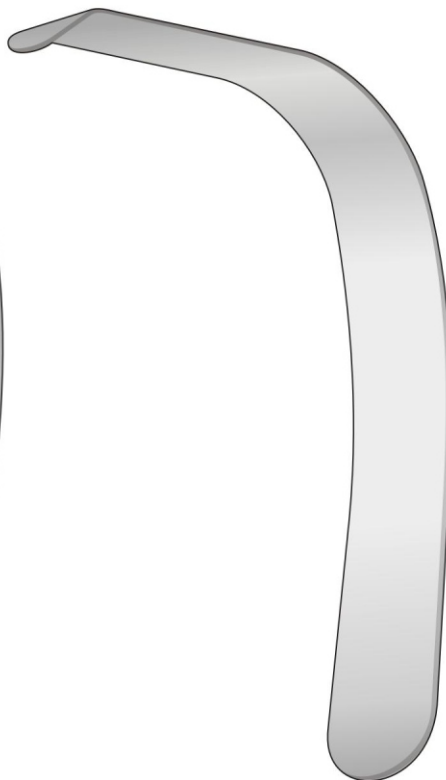

LACK  
HS-4598

15 x 22 mm

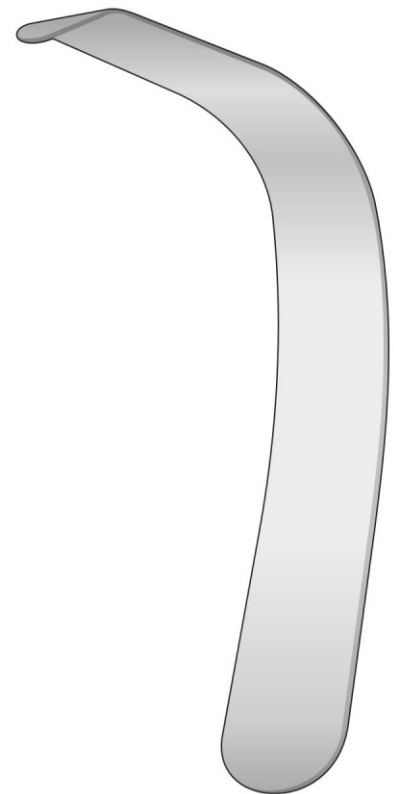

LACK  
HS-4599



*Osteotomes Hammer*

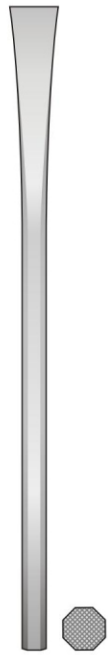

SHEEHAN  
HS-4604  
160 mm

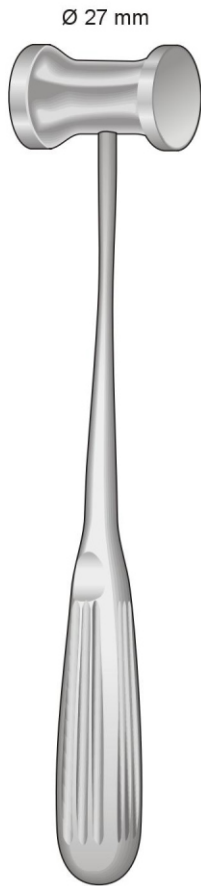
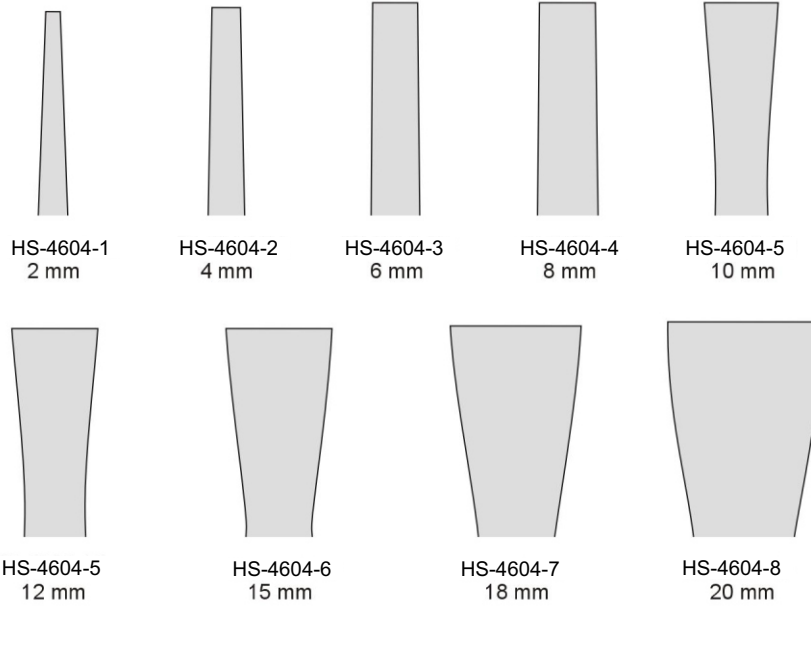

HAJEK  
HS-4601  
220 mm

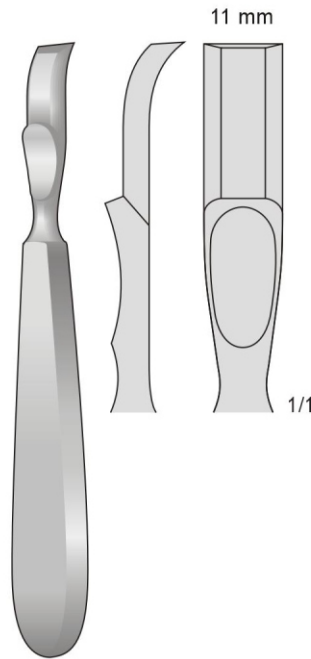

FARABEU-FOLLIN  
HS-4602  
160 mm

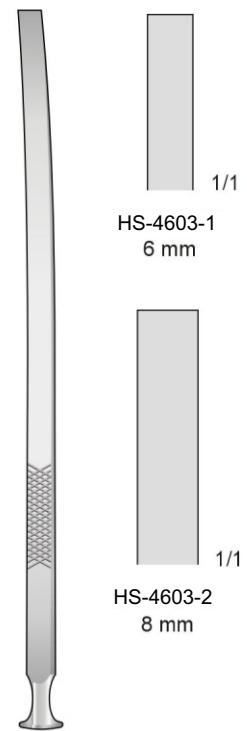

EPKER  
HS-4603  
180 mm

8 mm



COSCIA  
 HS-4605  
 180 mm

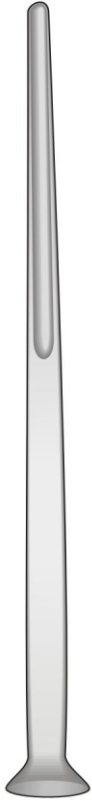

ALEXANDER  
 HS-4606  
 170 mm

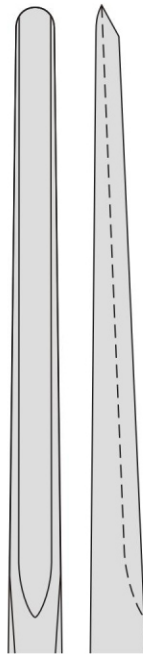

HS-4606-1  
 5 mm

1/1

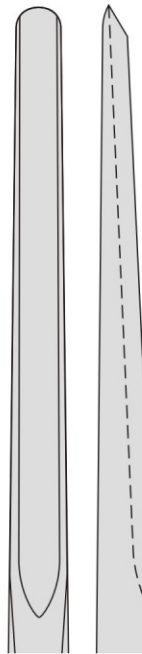

HS-4606-2  
 7 mm

1/1

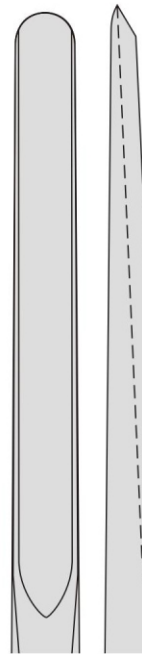

HS-4606-3  
 9 mm

1/1

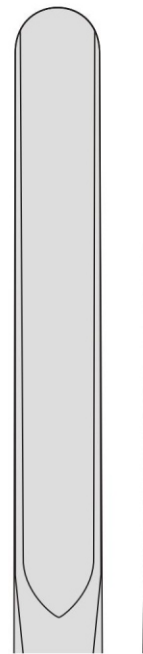

HS-4606-4  
 11 mm

1/1



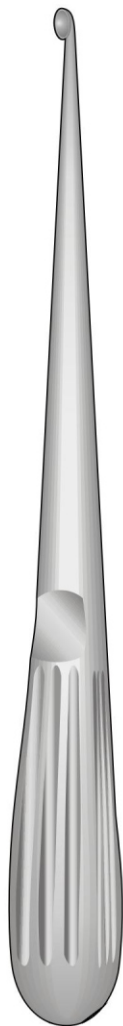

BRUNS  
 HS-4607  
 170 mm

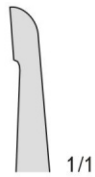

Fig.5/0  
 2,2 mm

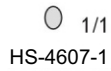

Fig.4/0  
 2,5 mm



Fig.3/0  
 2,8 mm



Fig.2/0  
 3,3 mm



Fig.0  
 3,6 mm



Fig.1  
 4,3 mm



Fig.2  
 4,8 mm

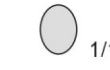

Fig.3  
 5,6 mm

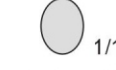

Fig.4  
 6,0 mm

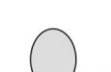

Fig.5  
 6,7 mm

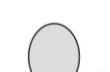

Fig.6  
 8,8 mm



HS-4607-9

HS-4607-10

HS-4607-11



BRUNS  
HS-4608  
225 mm

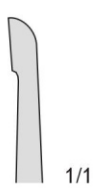









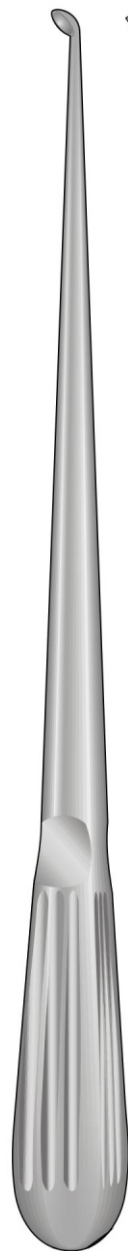

Fig.3/0 2,8 mm  1/1 HS-4608-1	Fig.2/0 3,3 mm  1/1 HS-4608-2	Fig.0 3,6 mm  1/1 HS-4608-3
Fig.1 4,3 mm  1/1 HS-4608-4	Fig.2 4,8 mm  1/1 HS-4608-5	Fig.3 5,6 mm  1/1 HS-4608-6
Fig.4 6,0 mm  1/1 HS-4608-7	Fig.5 6,7 mm  1/1 HS-4608-8	Fig.6 8,8 mm  1/1 HS-4608-9



BRUNS  
HS-4609  
225 mm

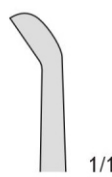









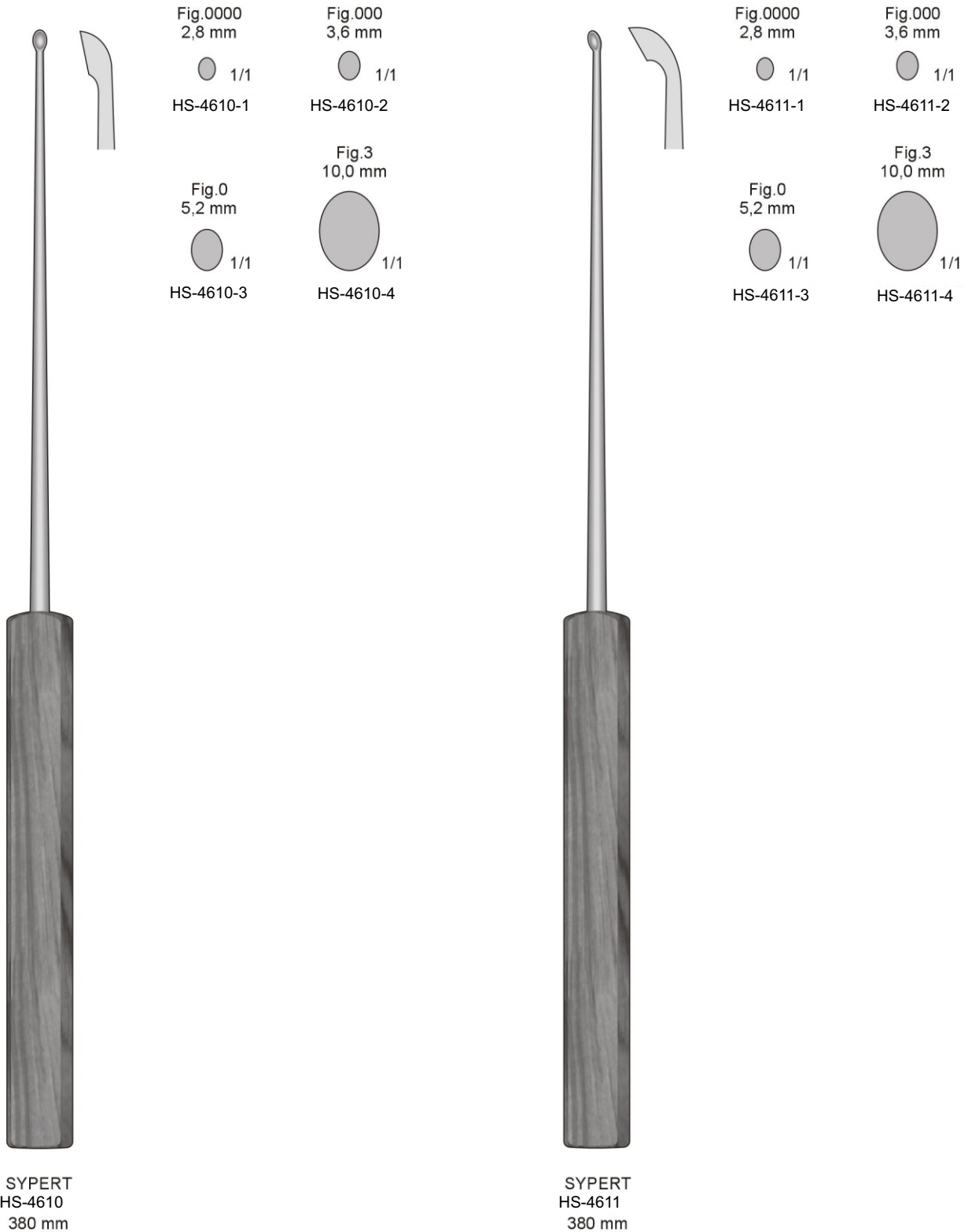
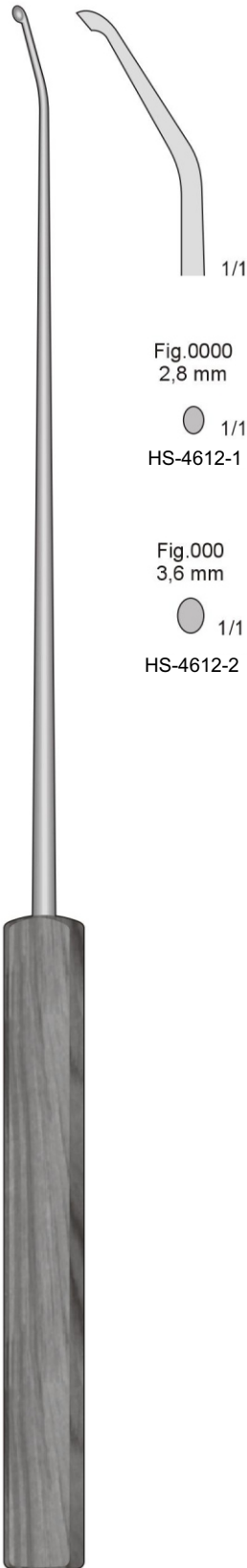

Fig.3/0 2,8 mm  1/1 HS-4609-1	Fig.2/0 3,3 mm  1/1 HS-4609-2	Fig.0 3,6 mm  1/1 HS-4609-3
Fig.1 4,3 mm  1/1 HS-4609-4	Fig.2 4,8 mm  1/1 HS-4609-5	Fig.3 5,6 mm  1/1 HS-4609-6
Fig.4 6,0 mm  1/1 HS-4609-7	Fig.5 6,7 mm  1/1 HS-4609-8	Fig.6 8,8 mm  1/1 HS-4609-9

Mit Ferrozellgriff - With Ferrozell handle  
 Con manico Ferrozell - Con mango de Ferrozell  
 Avec poignée en Ferrozell



Mit Ferrozellgriff - With Ferrozell handle  
Con manico Ferrozell - Con mango de Ferrozell  
Avec poignée en Ferrozell



SYPERT  
HS-4612  
420 mm

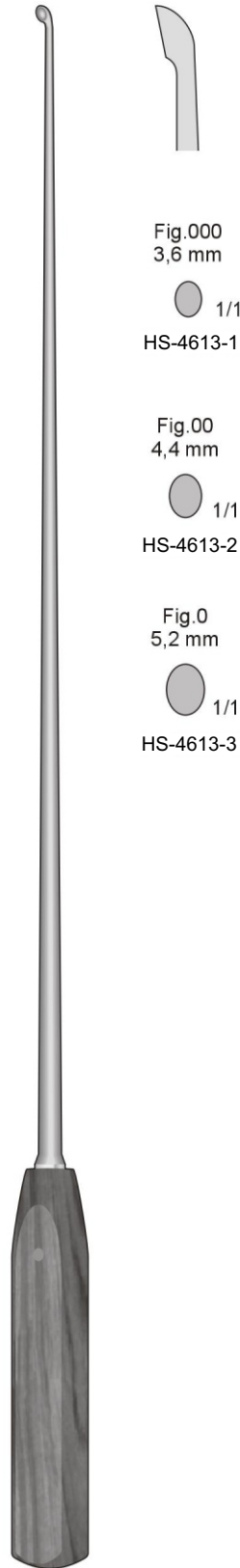

HS-4613  
410 mm

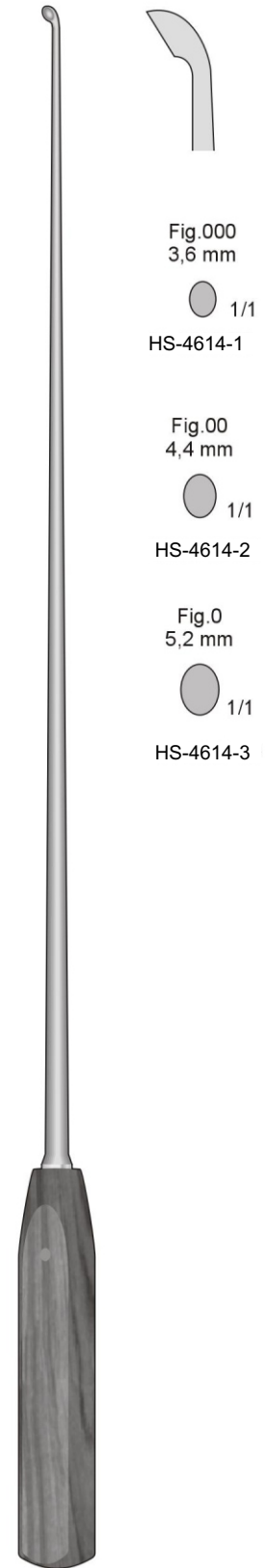

HS-4614  
410 mm

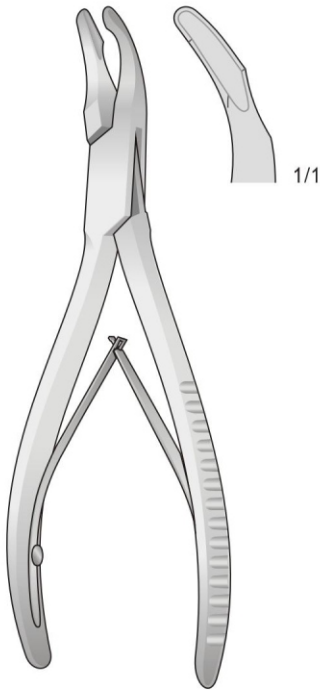

CLEVELAND  
 HS-4617 -14140 mm  
 HS-4617 -17170 mm

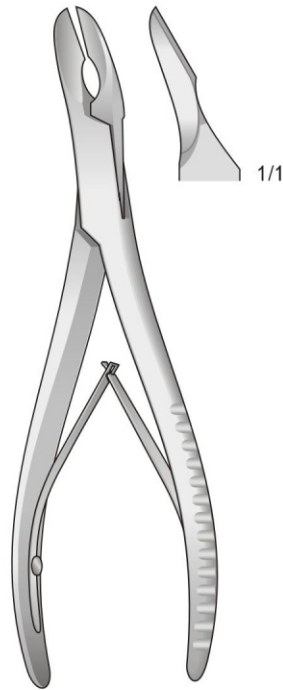

CLEVELAND  
 HS-4618 15 150 mm  
 HS-4618 17 170 mm

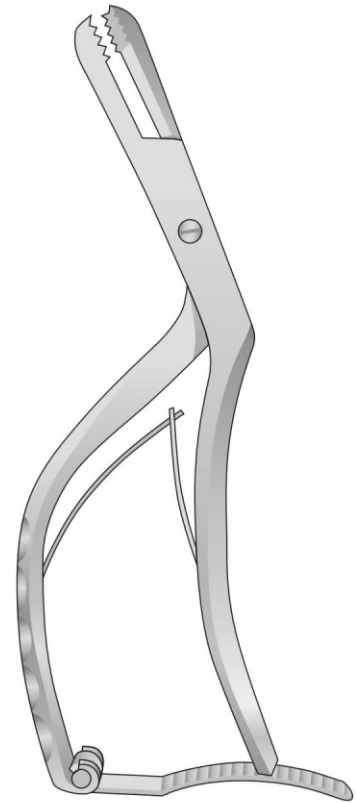

HS-4619  
 200 mm

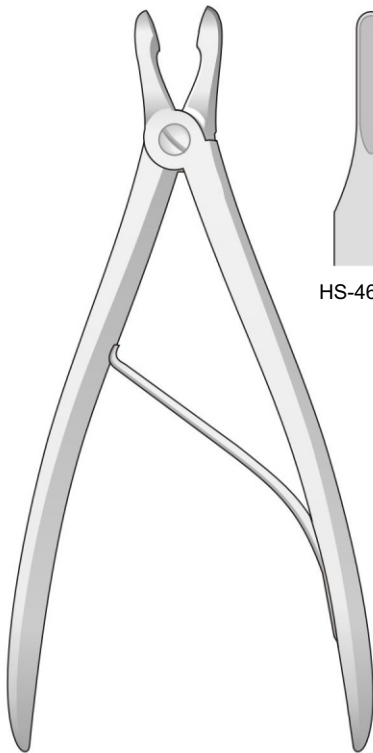

CUSHING  
 HS-4615  
 190 mm

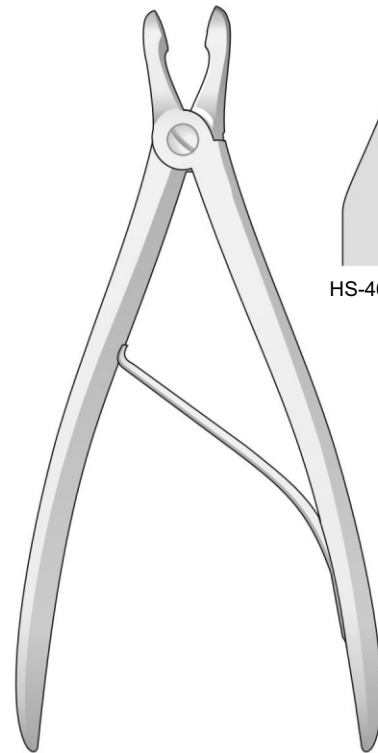
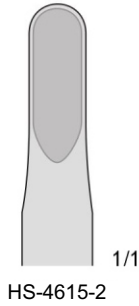
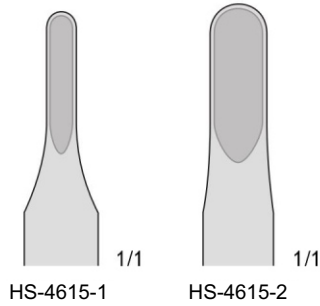

CUSHING  
 HS-4616  
 190 mm

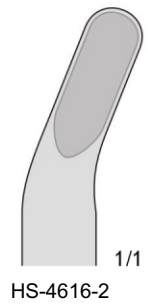
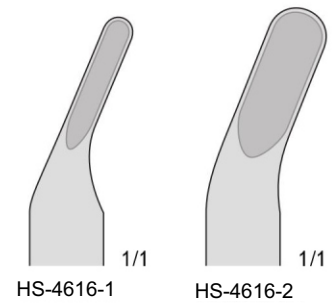

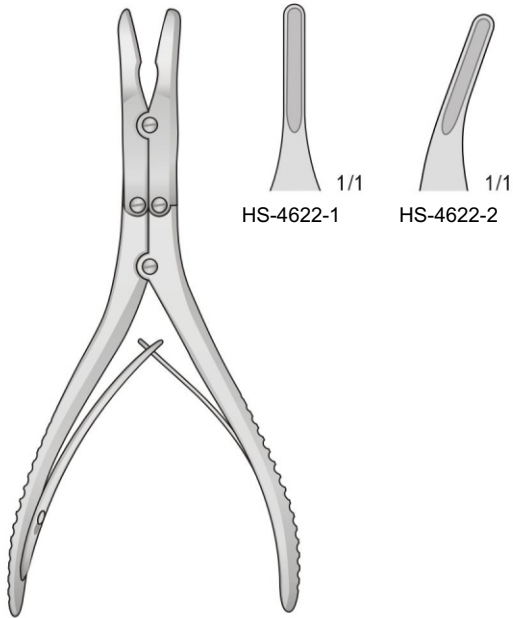

RUSKIN  
 HS-4622  
 150 mm

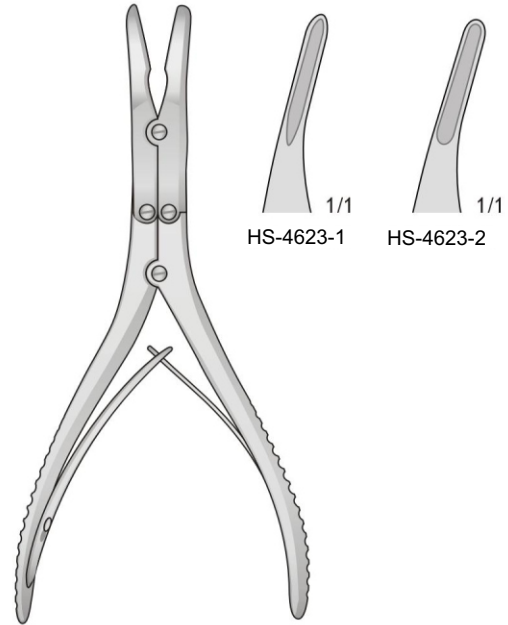

KLEINERT-KUTZ  
 HS-4623  
 155 mm

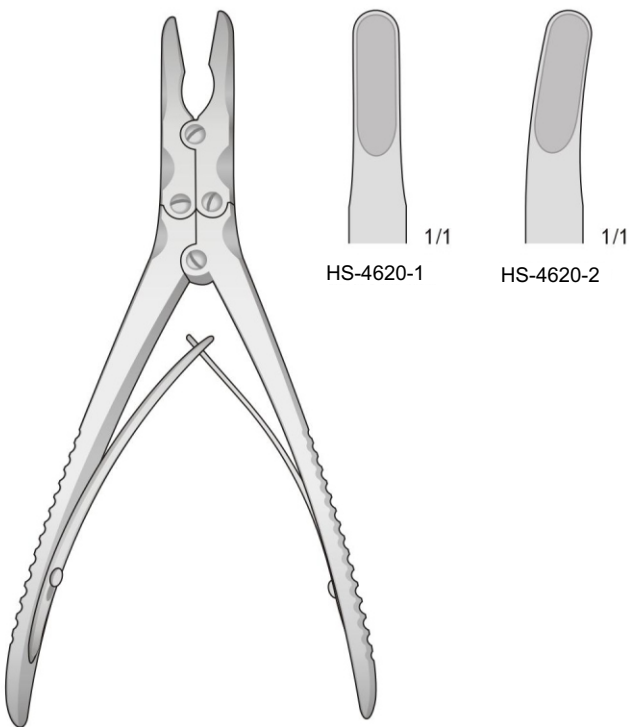

RUSKIN  
 HS-4620  
 185 mm

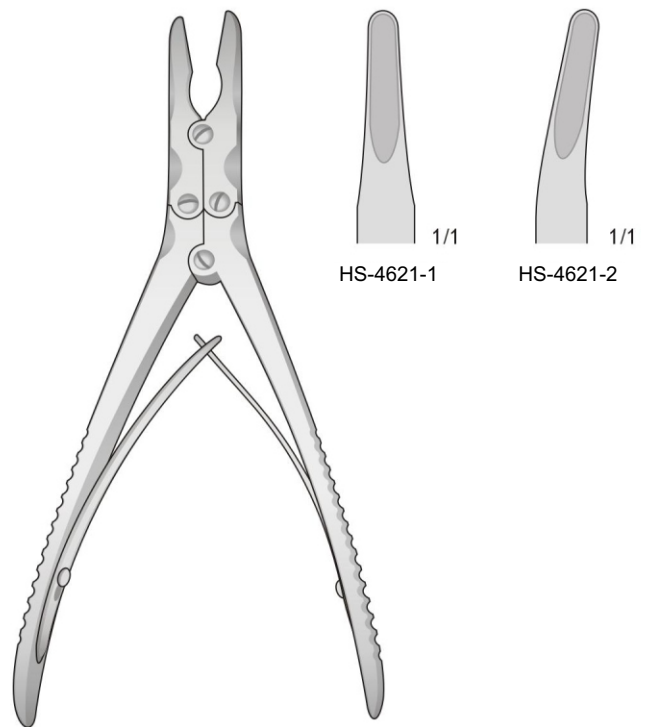

RUSKIN  
 HS-4621  
 185 mm



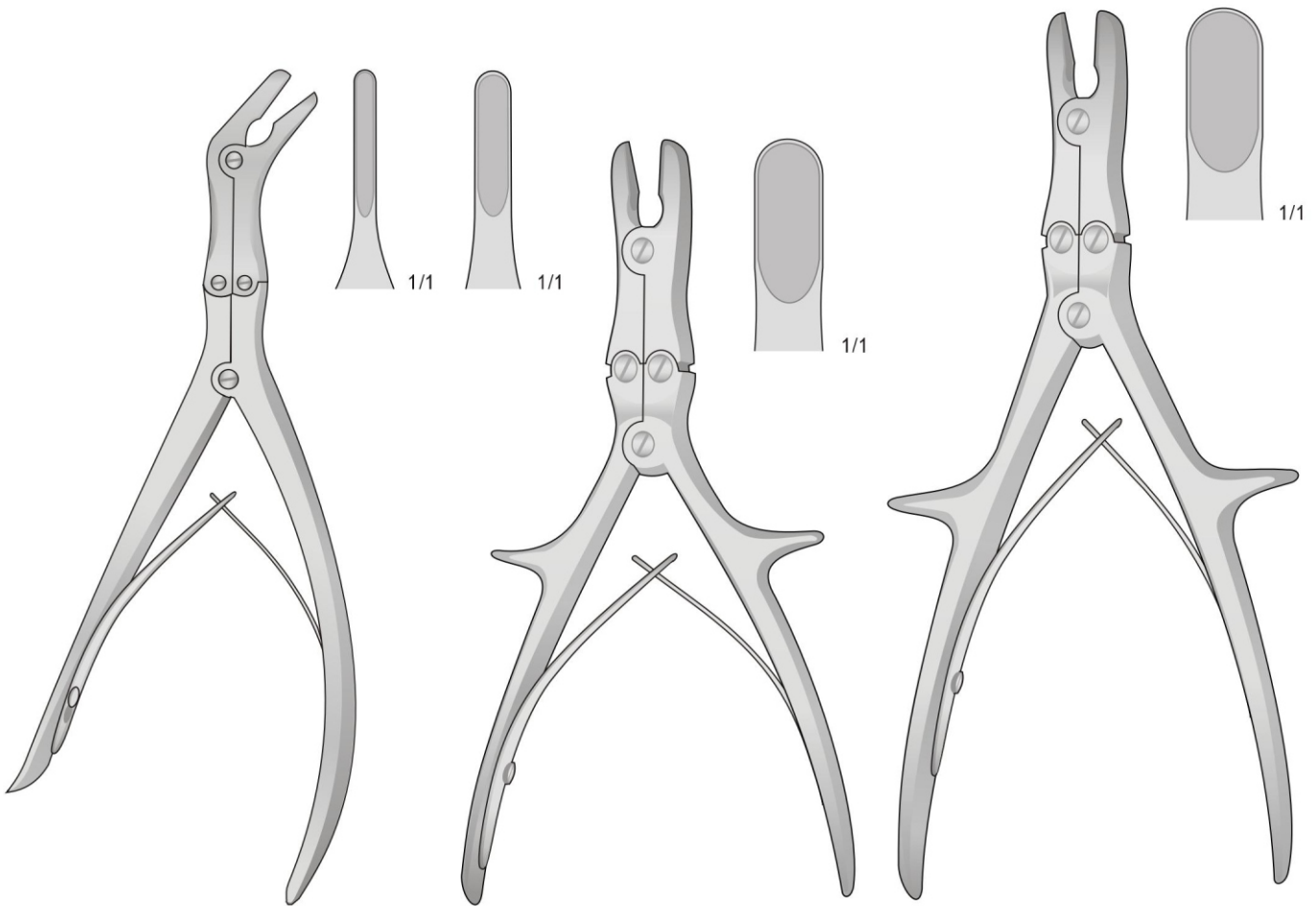

LEKSELL  
HS-4624  
250 mm

LUER-STILLE  
HS-4625  
220 mm

LUER-STILLE  
HS-4626  
260 mm

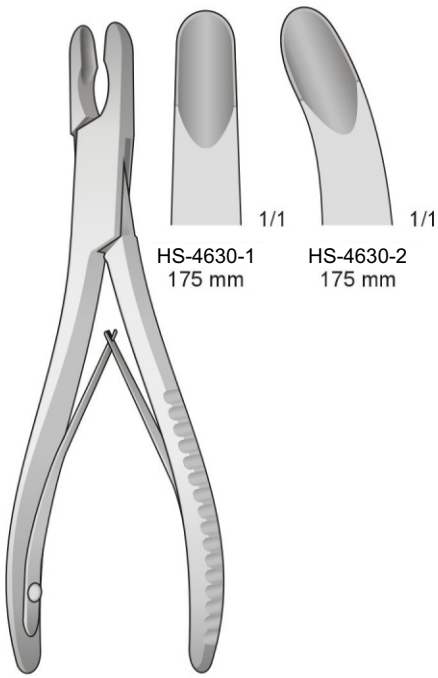

LUER  
 HS-4630  
 175 mm

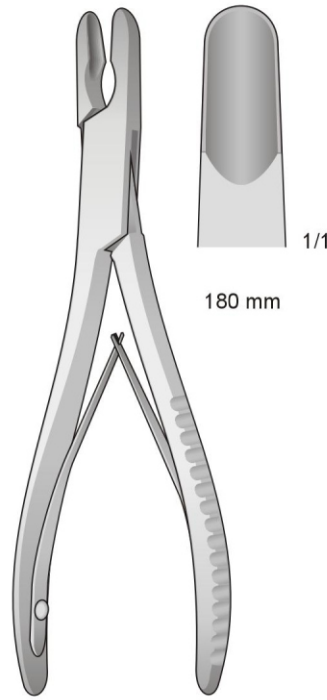

LUER  
 HS-4631  
 180 mm

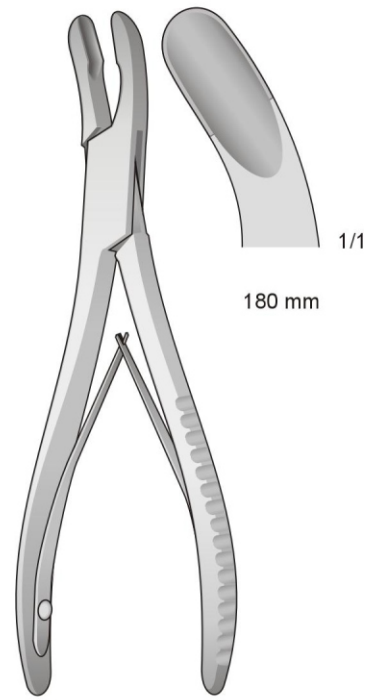

LUER  
 HS-4632  
 180 mm

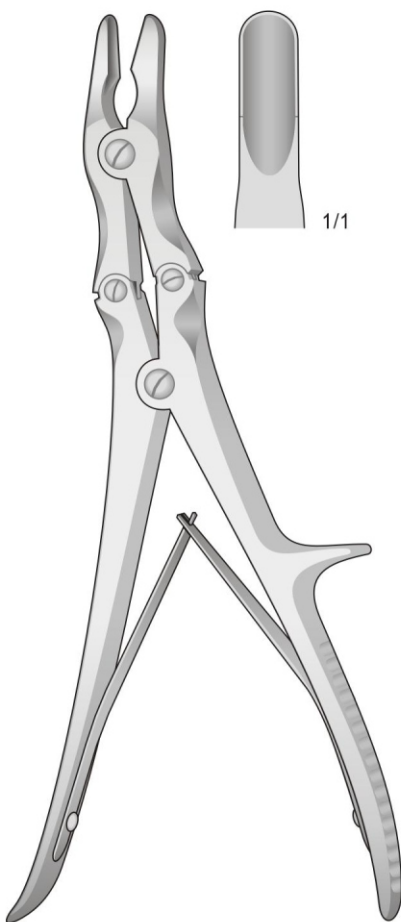

LEKSELL-STILLE  
 HS-4627  
 240 mm

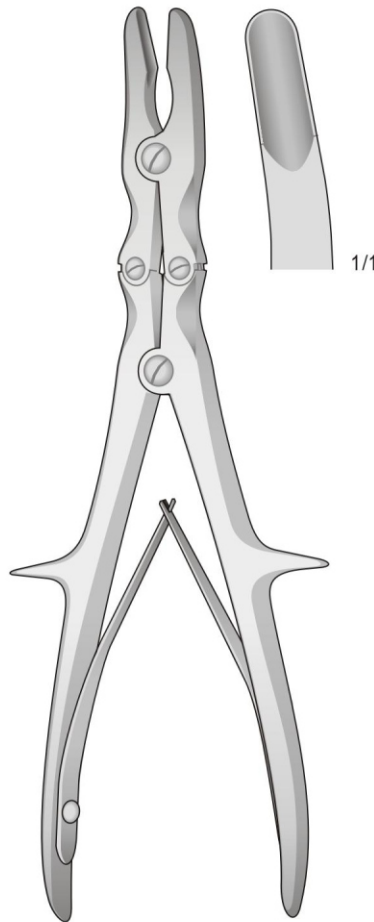

STILLE-RUSKIN  
 HS-4628  
 240 mm

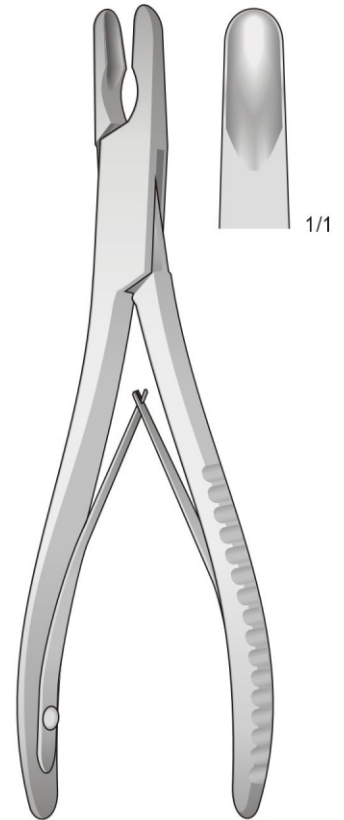

ADSON  
 HS-4629  
 210 mm

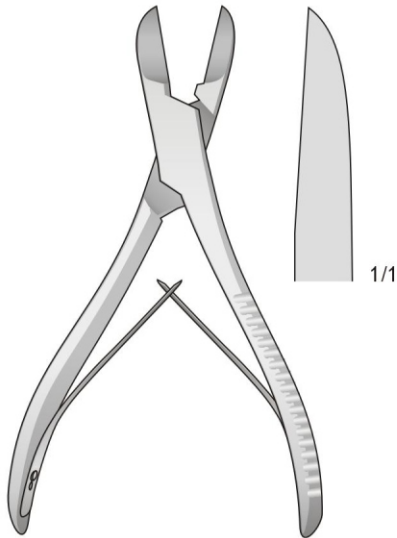

LISTON  
 HS-4635  
 140 mm

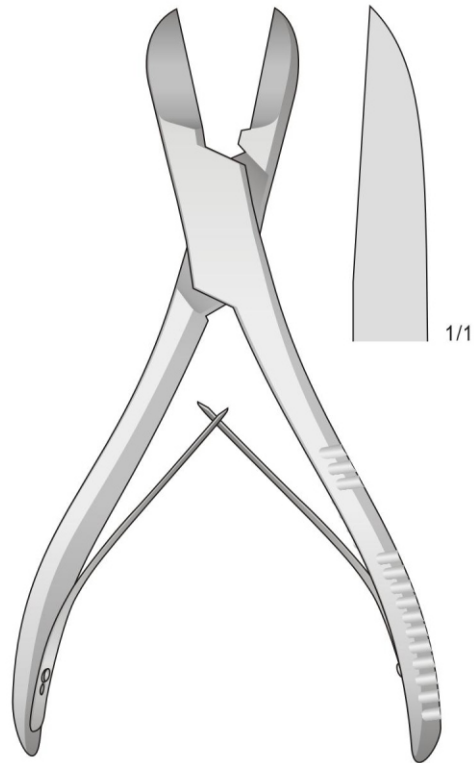

LISTON  
 HS-4636  
 200 mm

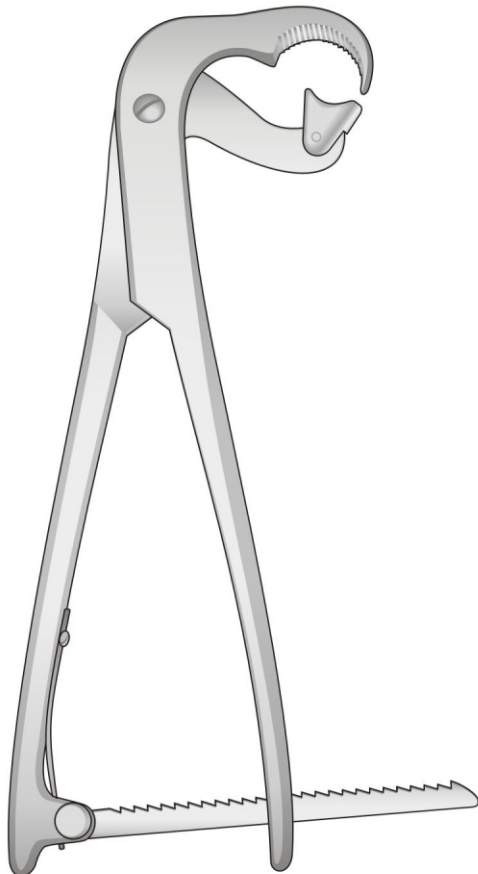

HS-4633  
 275 mm

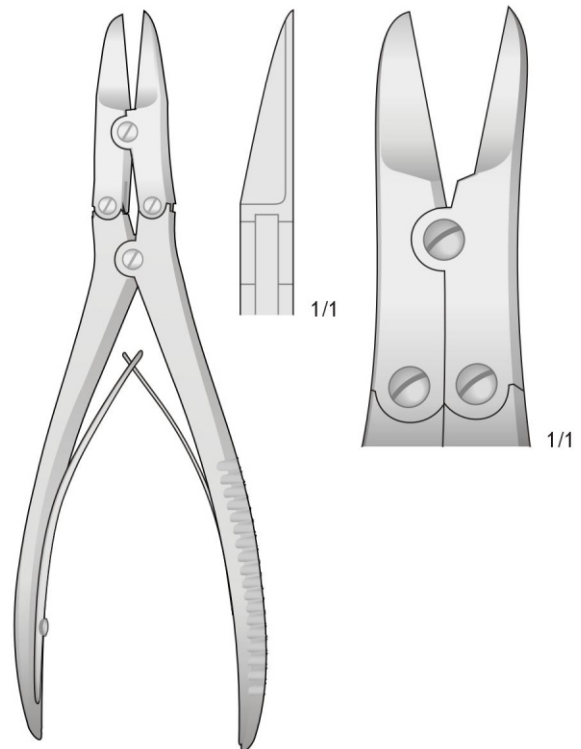

RUSKIN-LISTON  
 HS-4634  
 190 mm

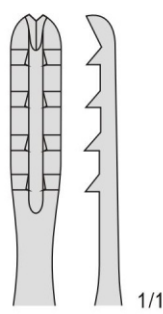
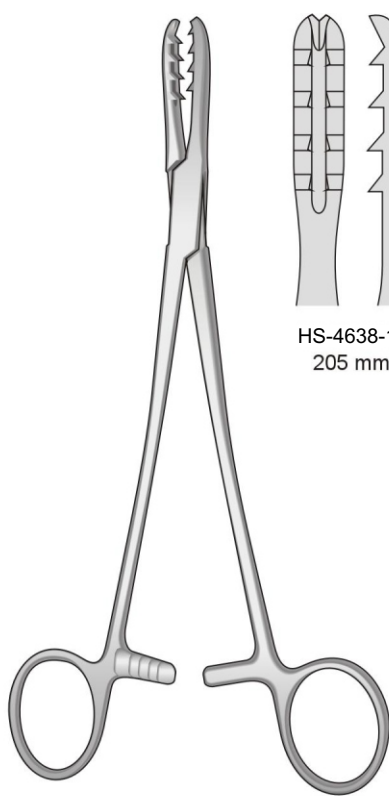

HS-4638-1  
205 mm

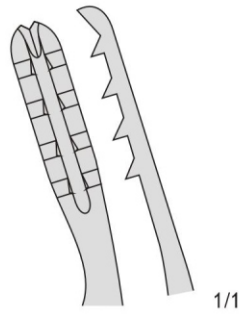

HS-4638-2  
205 mm

BIRCHER-GANSKE  
HS-4638  
205 mm

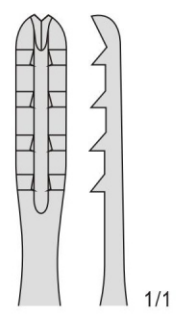
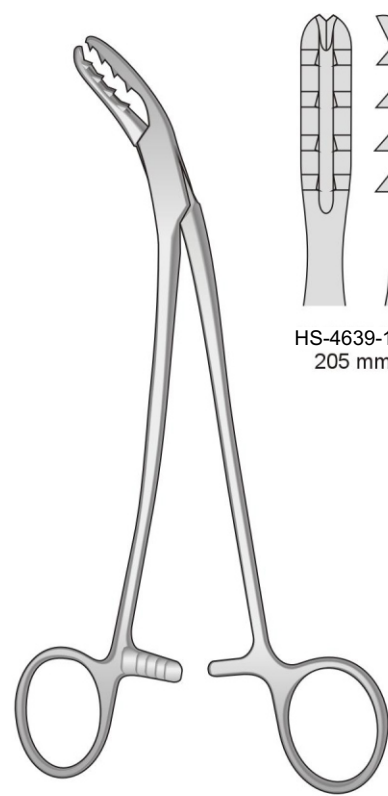

HS-4639-1  
205 mm

BIRCHER-GANSKE  
HS-4639  
200 mm

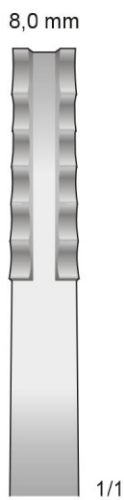
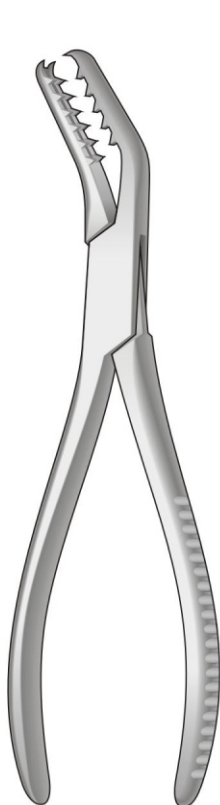

SEMB  
HS-4636  
190 mm

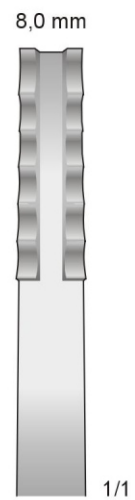
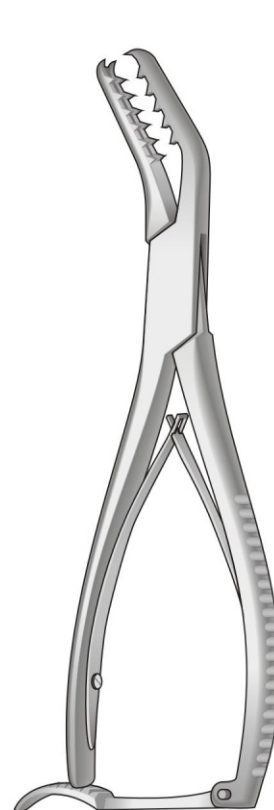

SEMB  
HS-4637  
190 mm

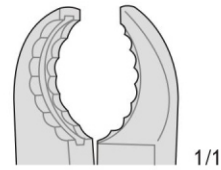
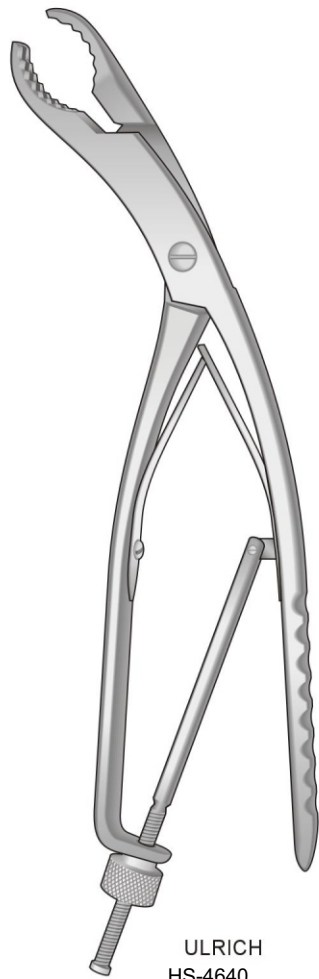
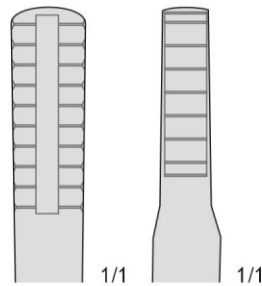
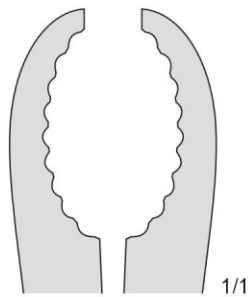

HS-4640-1  
 220 mm

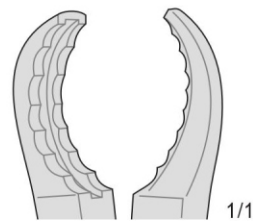

HS-4640-2  
 240 mm

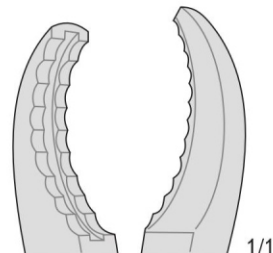

HS-4640-3  
 270 mm



Ersatz für  
Replacement for  
Ricambio per  
Repuesto para  
HS-4643

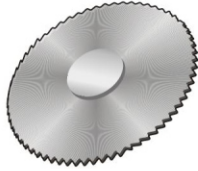

Von Kirschner-Drähten Ø 6 mm  
For Kirschner wires Ø 6 mm  
Per chiodi Kirschner Ø 6 mm

Von Kirschner-Drähten Ø 6 mm  
For Kirschner wires Ø 6 mm  
Per chiodi Kirschner Ø 6 mm



HS-4641  
450 mm

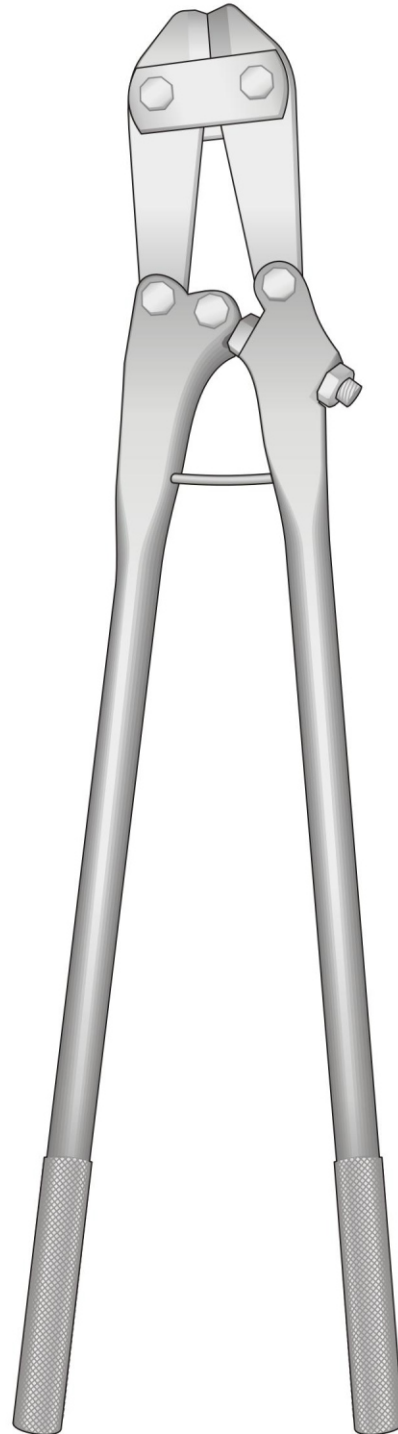

HS-4642  
560 mm

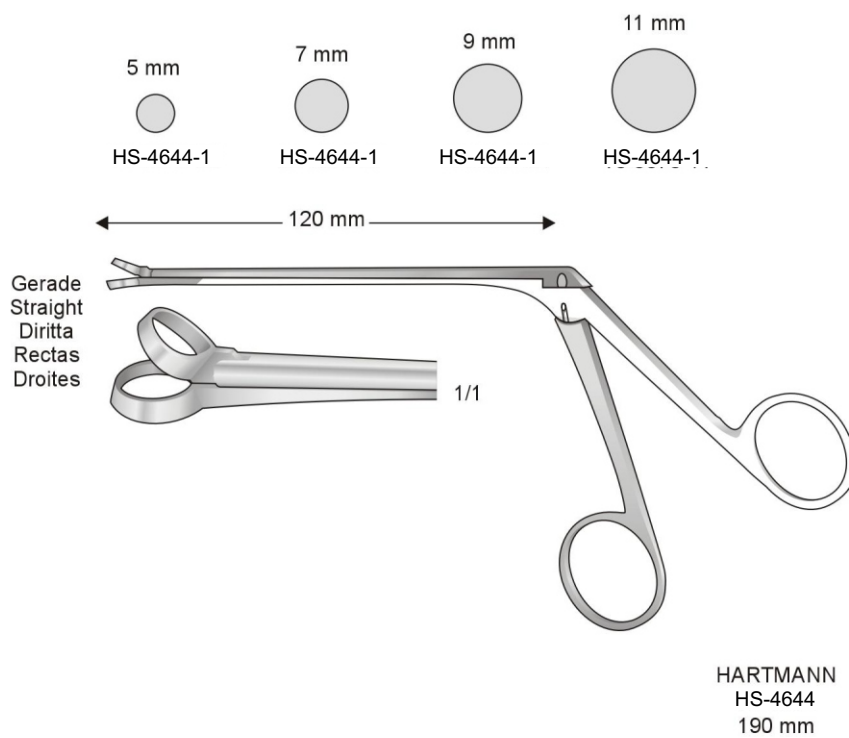
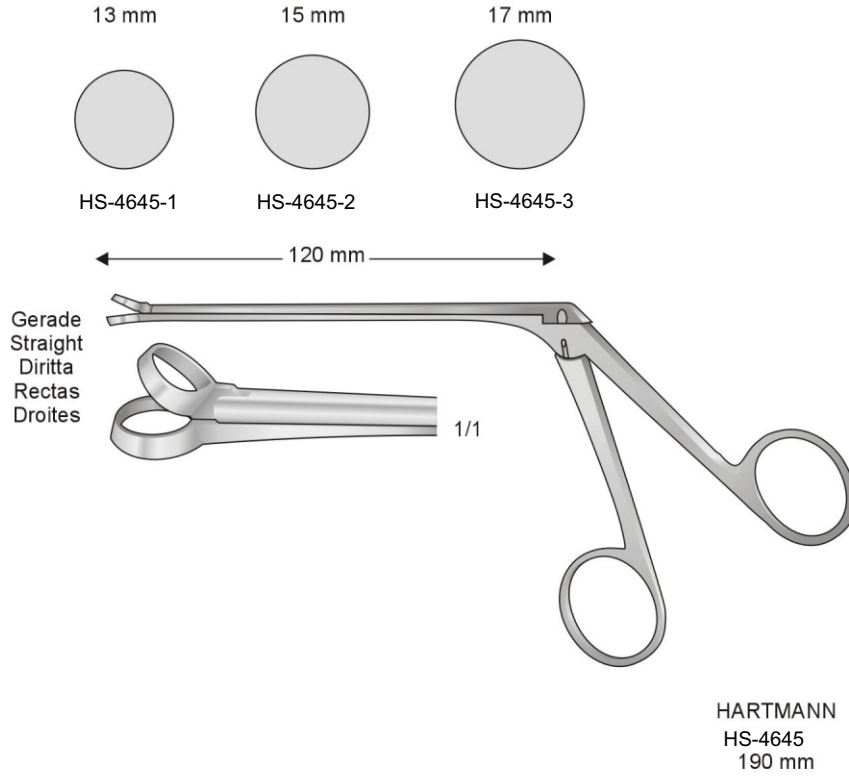





Sehnenschäler  
Tendon Stripper  
Enucleatore per tendini  
Enucleador de tendones  
Décolleurs de tendons

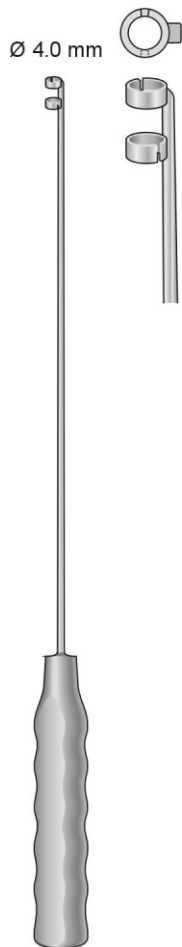

FISCHER  
HS-4646  
310 mm

Sehneneinflechtklemmen - Tendon Interlacing Forceps  
Pinze per intrecciare tendini - Pinzas para entrelazar tendones  
Pincas pour entrelacer les tendons

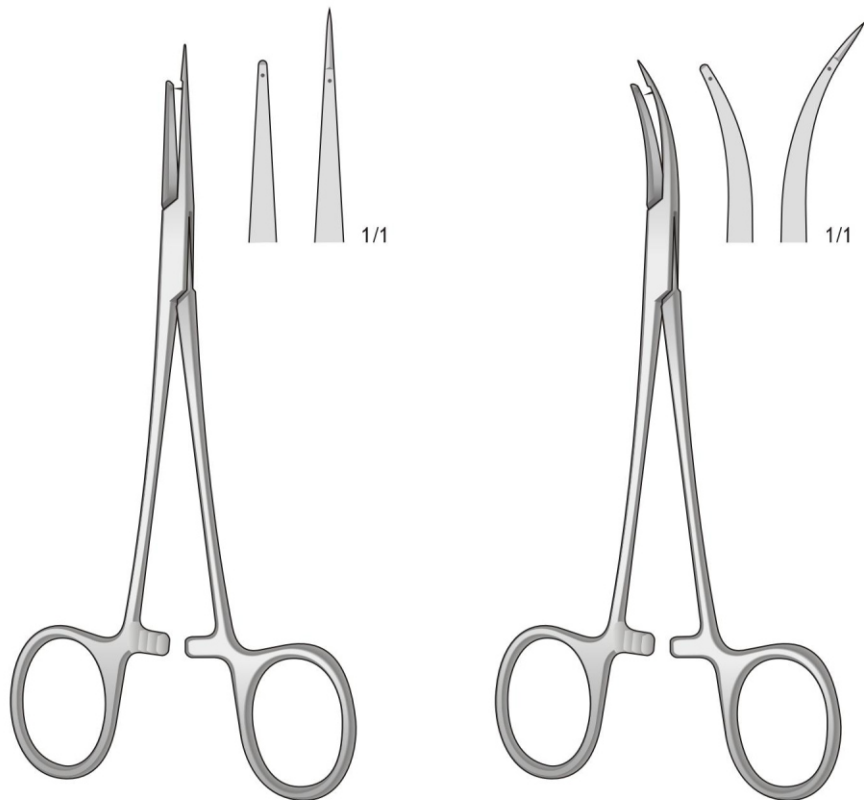

HS-4647  
150 mm

HS-4648  
150 mm

**Micro Ear Forceps**

**Rohrschaft. Mikro-Faßzängchen - Micro ear forceps with tubular shaft**

Mikro-Löffelzängchen Micro cup shaped forceps Micro pinze a cucchiaino		Mikro-Scheren Micro scissors Micro forbici	
0,9 x 1,0 mm ○ Oval Ovale Ovales		HS-4649-1 Gerade - Straight Diritta - Recta Droit	 BELLUCCI HS-4649-8 Gerade Straight Diritta Recta Droit
0,9 x 1,0 mm ○ Oval Ovale Ovales		HS-4649-2 Nach Oben Gebogen Curved up Curva in alto	 BELLUCCI HS-4649-9 Nach Oben Gebogen Curved up Curva in alto
0,8 x 1,3 mm ○ Oval Ovale Ovales		WULLSTEIN HS-4649-3 Gerade - Straight Diritta - Recta Droit	 BELLUCCI HS-4649-10 Links Gebogen Curved to left Curva a sinistra Curvas a la izquierda Courbes à gauche
0,8 x 1,3 mm ○ Oval Ovale Ovales		WULLSTEIN HS-4649-4 Links Gebogen - Curved to left Curva a sinistra - Curvas a la izquierda Courbes à gauche	 BELLUCCI HS-4649-11 Rechts Gebogen Curved to right Curva a destra Curvas a la derecha Courbes à droite
0,8 x 1,3 mm ○ Oval Ovale Ovales		WULLSTEIN HS-4649-5 Rechts Gebogen - Curved to right Curva a destra - Curvas a la derecha Courbes à droite	 BELLUCCI HS-4649-12 Orizzontale
1,0 mm ○ Rund Round Tonda		WULLSTEIN HS-4649-6 Gerade - Straight Diritta - Recta Droit	
1,7 x 2,5 mm ○ Oval Ovale Ovales		WULLSTEIN HS-4649-7 Gerade - Straight Diritta - Recta Droit	

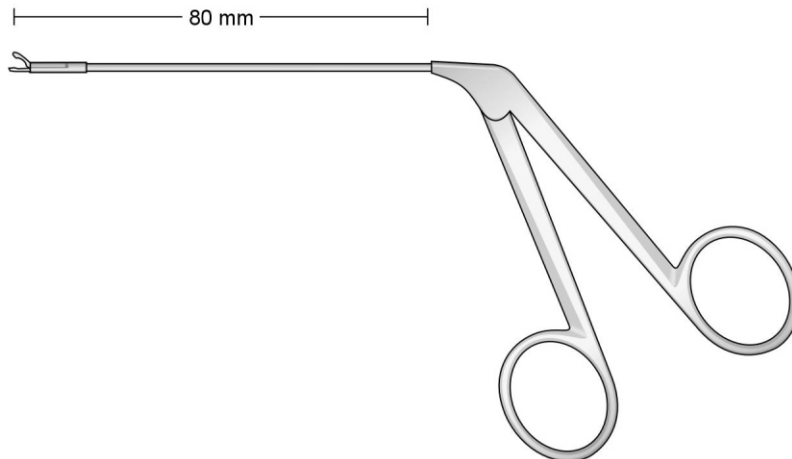

HS-4649  
80 mm

0,6 x 0,5 mm



HS-4650-1  
Gerade  
Straight  
Diritta  
Recta  
Droit

0,9 x 1,1 mm



HS-4650-5  
Gerade  
Straight  
Diritta  
Recta  
Droit

0,6 x 0,5 mm



HS-4650-2  
Links Gebogen  
Curved to left  
Curva a sinistra  
Curvas a la izquierda  
Courbes à gauche

0,9 x 1,1 mm



HS-4650-6  
Links Gebogen  
Curved to left  
Curva a sinistra  
Curvas a la izquierda  
Courbes à gauche

0,6 x 0,5 mm



HS-4650-3  
Rechts Gebogen  
Curved to right  
Curva a destra  
Curvas a la derecha  
Courbes à droite

0,9 x 1,1 mm



HS-4650-7  
Rechts Gebogen  
Curved to right  
Curva a destra  
Curvas a la derecha  
Courbes à droite

0,6 x 0,5 mm



HS-4650-4  
Nach Oben Gebogen  
Curved up  
Curva in alto

0,9 x 1,1 mm



HS-4650-8  
Nach Oben Gebogen  
Curved up  
Curva in alto

0,9 x 1,1 mm



HS-4650-9  
Nach Unten Gebogen  
Curved down  
Curva in basso

Schaft zerlegbar  
Dismantable shaft  
Asta smontabile  
Vástago desmontable  
Tige démontable

80 mm

Superfein  
Extremely delicate  
Modello super fine  
Superfina  
Modèle superfin

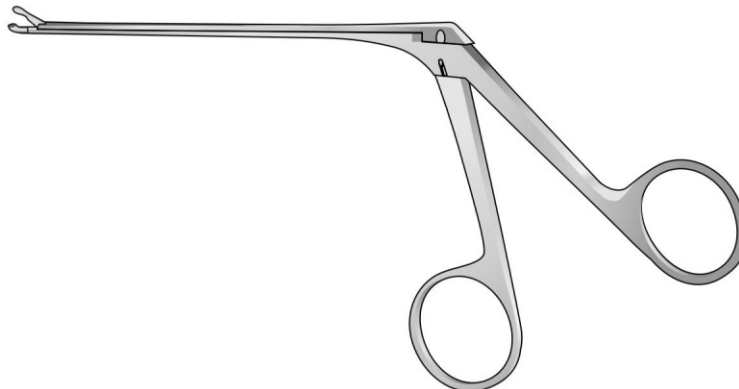

HS-4650  
80 mm

6,0 x 0,8 mm



SCHUKNECHT

HS-4651-1  
Gerade  
Straight  
Diritta  
Recta  
Droit

4,0 x 0,5 mm

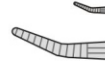

HS-4651-5  
Rechts Gebogen  
Curved to right  
Curva a destra  
Curvas a la derecha  
Courbes à droite

5,0 x 0,8 mm



GREVEN  
HS-4651-2  
Gerade  
Straight  
Diritta  
Recta  
Droit

4,0 x 0,5 mm

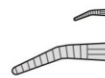

HS-4651-6  
Links Gebogen  
Curved to left  
Curva a sinistra  
Curvas a la izquierda  
Courbes à gauche

4,0 x 0,5 mm

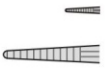

HS-4651-3  
Gerade  
Straight  
Diritta  
Recta  
Droit

4,0 x 0,5 mm

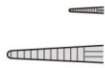

HS-4651-7  
Nach Oben Gebogen  
Curved up  
Curva in alto

4,0 x 0,5 mm

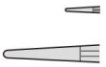

HS-4651-4  
Glattes Maul  
Smooth jaws  
Morso liscio  
Mandibula lisa  
Mors lisses

4,0 x 0,5 mm



HS-4651-8  
Nach Unten Gebogen  
Curved down  
Curva in basso

Schaft zerlegbar  
Dismantable shaft  
Asta smontabile  
Vástago desmontable  
Tige démontable

Superfein  
Extremely delicate  
Modello super fine  
Superfina  
Modèle superfin

80 mm

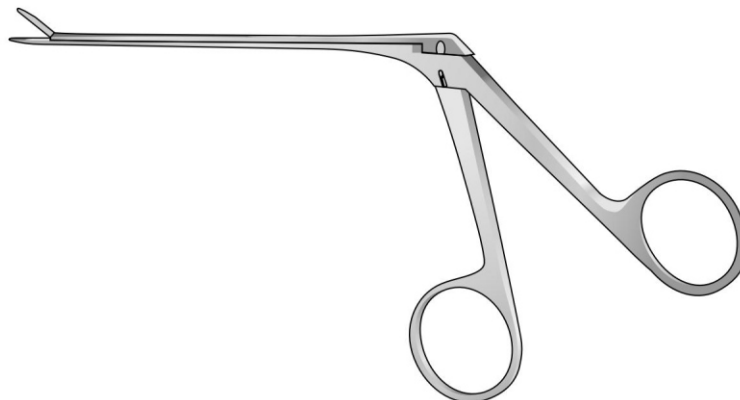

HS-4651  
80 mm



**Rohrschaft. Mikro-Faßzängchen**  
**Micro ear forceps with tubular shaft**

0,8 x 3,5 mm

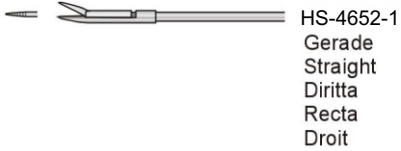

0,8 x 3,5 mm

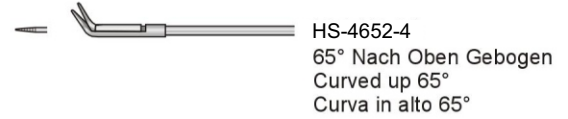

1,0 x 5,0 mm

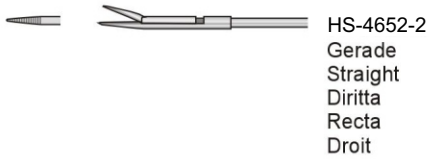

0,8 x 3,5 mm

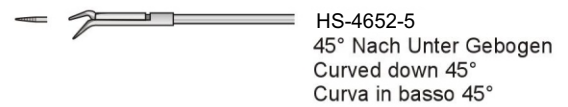

1,5 x 6,0 mm

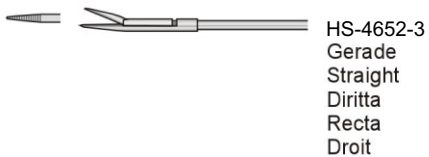

1,0 x 5,0 mm

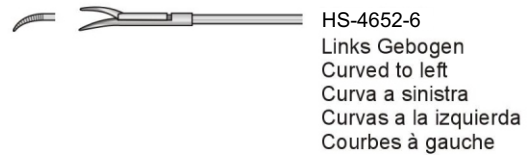

1,0 x 5,0 mm

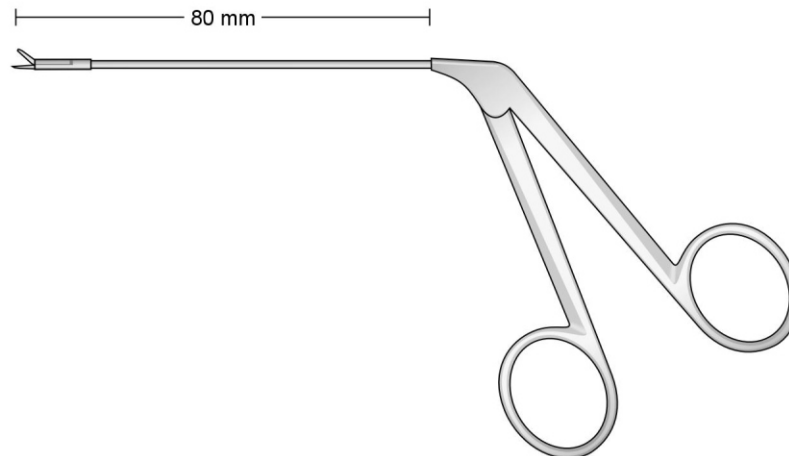
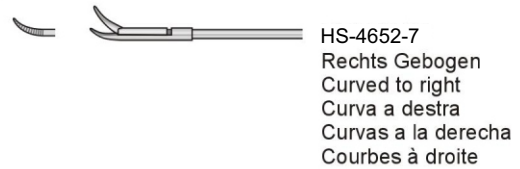

HS-4652  
80 mm



HS-4653-1  
Gerade  
Straight  
Rette  
Rectas  
Droits



HS-4653-2  
Gerade, horizontal schneidend  
Straight, horizontally cutting  
Rette, taglio orizzontale  
Rectas, de corte horizontal  
Droits, à coupe horizontale



HS-4653-3  
Nach links gebogen  
Curved to left  
Curve a sinistra  
Acodadas hacia la izquierda  
Courbes à gauche



HS-4653-4  
Nach rechts gebogen  
Curved to right  
Curve a destra  
Acodadas hacia la derecha  
Courbes à droite



HS-4653-5  
Nach oben abgewinkelt  
Angled up  
Angolate in alto  
Angulada hacia arriba  
Coudés vers le haut



HS-4653-6  
Nach unten abgewinkelt  
Angled down  
Angolate in basso  
Angulada hacia abajo  
Coudés vers le bas



HS-4653-7  
Gerefties maul, gerade  
Serrated jaws, straight  
Morsi zigrinati, retti  
Boca estriada, recta  
Mors striés, droits



HS-4653-8  
Gerefties maul, rechts gebogen  
Serrated jaws, right  
Morsi zigrinati, curvi a destra  
Boca estriada, curva a la derecha  
Mors striés, courbes à droite



HS-4653-9  
Gerefties maul, links gebogen  
Serrated jaws, left  
Morsi zigrinati, curvi a sinistra  
Boca estriada, curva a la izquierda  
Mors striés, courbes à gauche

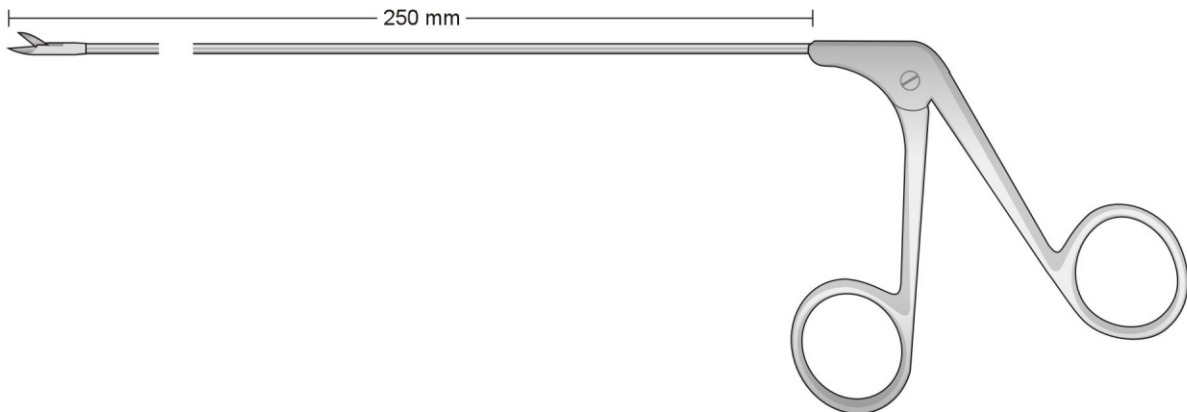

HS-4653  
250 mm



HS-4654-1  
Rundes Löffelmaul, gerade  
Round cup jaws, straight  
Morso a forma di cucchiaio rotondo, retto  
Boca redonda en forma de cucharilla, recta  
Mors ronds en cuiller, droits



HS-4654-2  
Rundes Löffelmaul, nach oben  
Round cup jaws, up  
Morso a forma di cucchiaio rotondo, in alto  
Boca redonda en forma de cucharilla, arriba  
Mors ronds en cuiller, courbes en haut



HS-4654-3  
Rundes Löffelmaul, rechts  
Round cup jaws, right  
Morso a forma di cucchiaio rotondo, destra  
Boca redonda en forma de cucharilla, a la derecha  
Mors ronds en cuiller, courbes à droite



HS-4654-4  
Rundes Löffelmaul, links  
Round cup jaws, left  
Morso a forma di cucchiaio rotondo, sinistra  
Boca redonda en forma de cucharilla, a la izquierda  
Mors ronds en cuiller, courbes à gauche



HS-4654-5  
Ovales Löffelmaul, gerade  
Oval cup jaws, straight  
Morso a forma di cucchiaio ovale, retto  
Boca ovalada en forma de cucharilla, recta  
Mors ovales en cuiller, droits



HS-4654-6  
Ovales Löffelmaul, nach oben  
Oval cup jaws, up  
Morso a forma di cucchiaio ovale, in alto  
Boca ovalada en forma de cucharilla, arriba  
Mors ovales en cuiller, courbes en haut



HS-4654-7  
Ovales Löffelmaul, rechts  
Oval cup jaws, right  
Morso a forma di cucchiaio ovale, destra  
Boca ovalada en forma de cucharilla, a la derecha  
Mors ovales en cuiller, courbes à droite



HS-4654-8  
Ovales Löffelmaul, links  
Oval cup jaws, left  
Morso a forma di cucchiaio ovale, sinistra  
Boca ovalada en forma de cucharilla, a la izquierda  
Mors ovales en cuiller, courbes à gauche



HS-4654-9  
Ovales Löffelmaul, gerade  
Oval cup jaws, straight  
Morso a forma di cucchiaio ovale, retto  
Boca ovalada en forma de cucharilla, recta  
Mors ovales en cuiller, droits



HS-4654-10  
Maulteile gefenstert  
Jaw fenestrated  
Morso fenestrato  
Boca fenestrada  
Mors ajourés

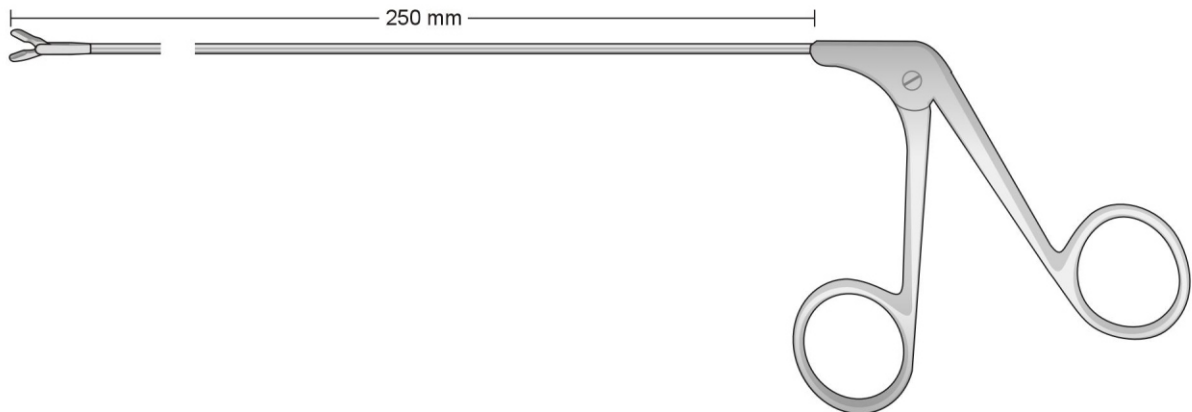

HS-4654  
250 mm





Gerade  
Stright  
Diritta  
Rectas  
Droites

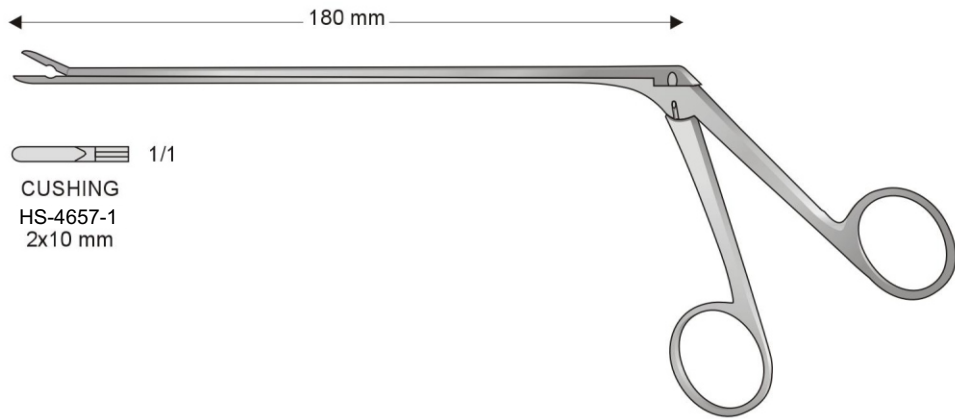

CUSHING  
HS-4657-1  
2x10 mm

CUSHING  
HS-4657

Aufwärtsgebogen  
Top curved  
Curva verso l'alto  
Curvos  
Courbe vers le haut

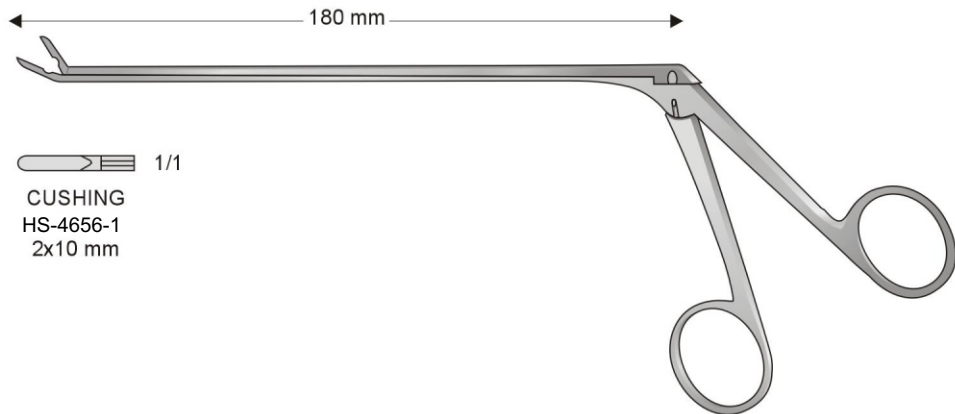

CUSHING  
HS-4656-1  
2x10 mm

CUSHING  
HS-4656

Abwärts gebogen  
Bottom curved  
Curva verso il basso  
Curvos  
Courbe vers le bas

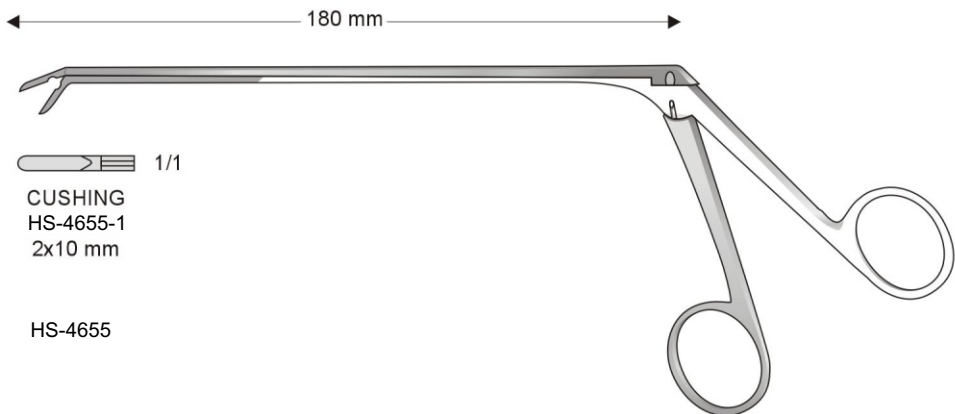

CUSHING  
HS-4655-1  
2x10 mm

HS-4655

CUSHING  
HS-4655



Katheter-Einführungsinstrumente  
Catheter introducing instruments  
Strumenti per tendere ed introdurre i cateteri  
Instrumentos para introducir catéteres  
Mandrin pour introduire les sondes

Ø 1,2 mm

Endospekula für Harnröhre und  
Cervix, ohne Sperre  
Endospecula for cervix and urethra,  
without ratchet

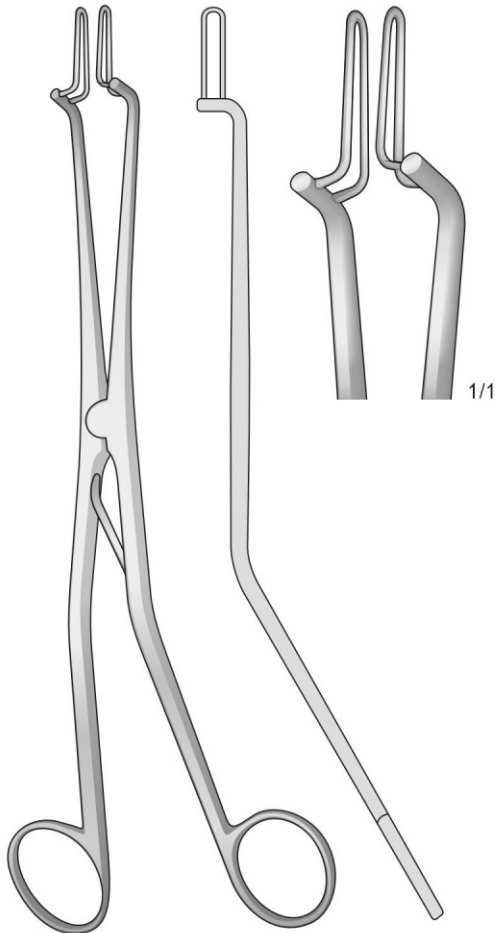

KOGAN  
HS-4658  
240 mm

Endospekula für Harnröhre und  
Cervix, mit Skalensperre und Fixierschraube  
Endospecula for cervix and urethra,  
with scale-ratchet and fixing screws  
Con cremagliera a scala e vite di fissaggio  
Con cremallera graduada y tornillo de fijación  
Avec crémaillère à échelle et vis à fixation

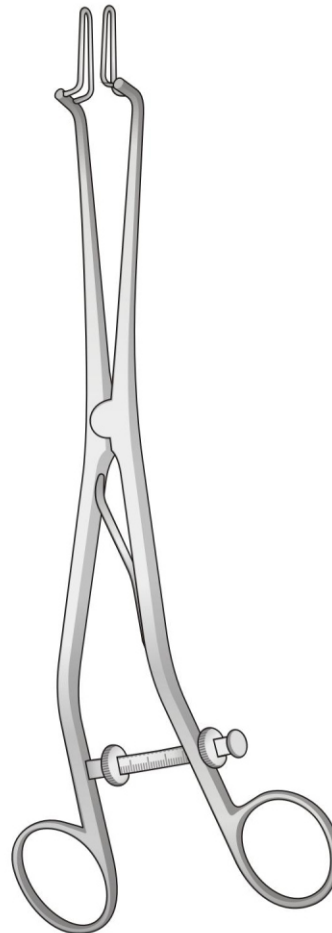

KOGAN  
HS-4659  
240 mm

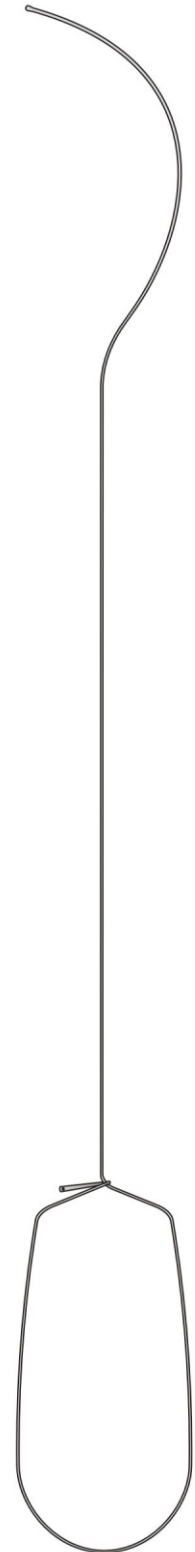

HS-4660  
425 mm

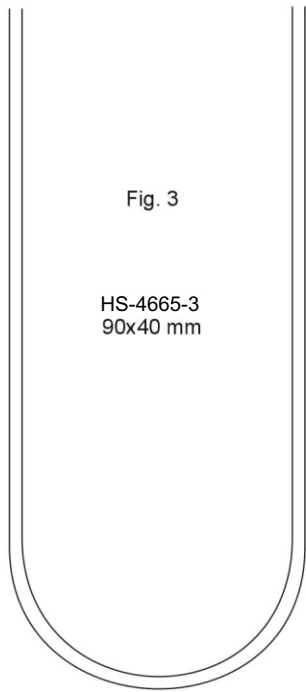

Fig. 3

HS-4665-3  
90x40 mm

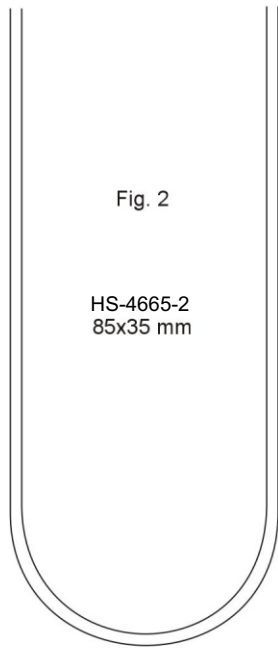

Fig. 2

HS-4665-2  
85x35 mm

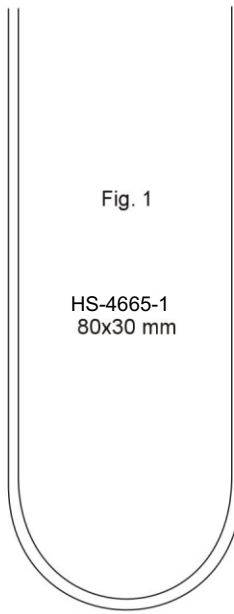
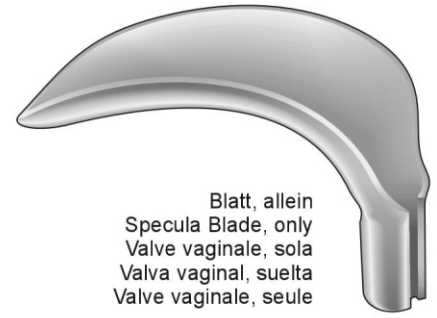

Fig. 1

HS-4665-1  
80x30 mm



Blatt, allein  
Specula Blade, only  
Valve vaginale, sola  
Valva vaginal, suelta  
Valve vaginale, seule

SCHERBAK  
HS-4665

Blasenhalsperrer  
Sounds Bladder  
Dilatatore del collo vescicale  
Sonda vesicales  
Dilatateur pour le col vésical

Biopsiekürette  
Uterine Biopsy Curette  
Curette per biopsia  
Curettes para biopsia  
Curettes pour biopsie

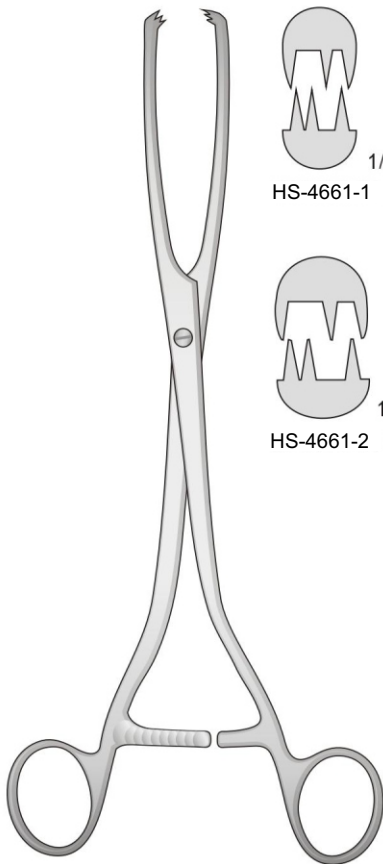

MUSEUX  
HS-4661  
265 mm

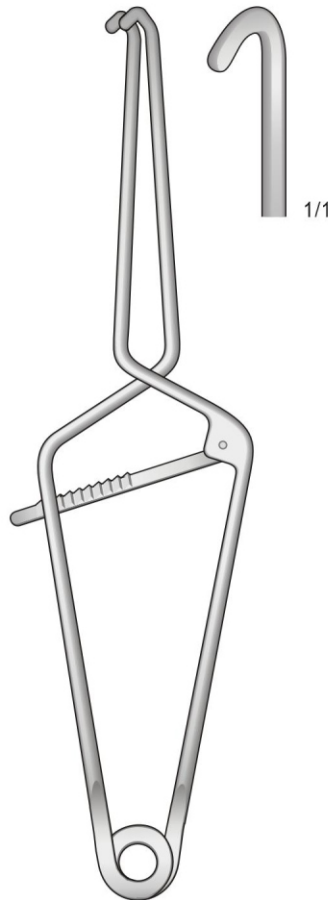

MILLIN  
HS-4662  
280 mm

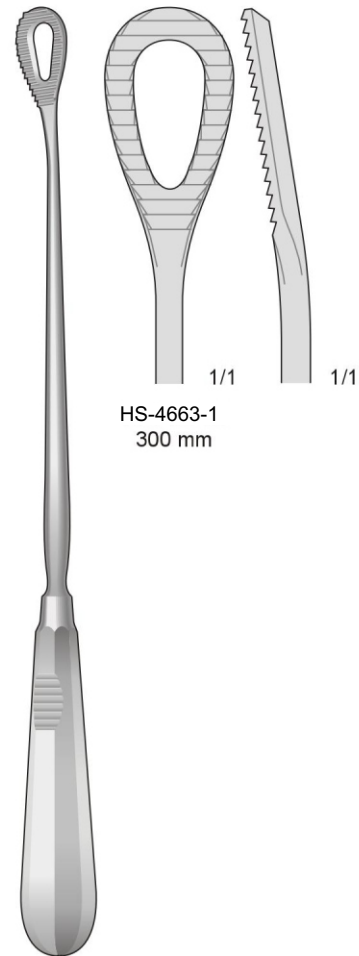

PESTALOZZA  
HS-4663  
300 mm

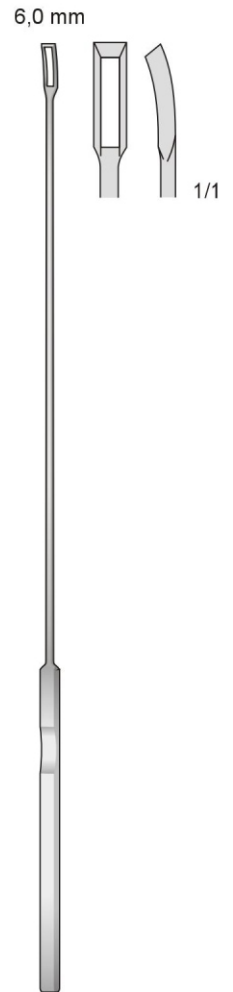

KEVORKIAN  
HS-4664  
300 mm



Gewicht zum Vaginalsepekulum  
Weight for Vaginal Speculum  
Peso per specolo vaginale  
Peso para espéculo vaginal  
Poids pour spéculum vaginal



SCHERBAK  
HS-4670-1 10,5 mm 400 gr  
HS-4670-2 13 mm 800 gr

Blatt, allein  
Specula Blade, only  
Valve vaginale, sola  
Valva vaginal, suelta  
Valve vaginale, seule



SCHERBAK  
HS-4669

Griff zum Vaginalsepekulum  
Handle for Vaginal Speculum  
Manico per specolo vaginale  
Mango para espéculo vaginal  
Manche pour spéculum vaginal

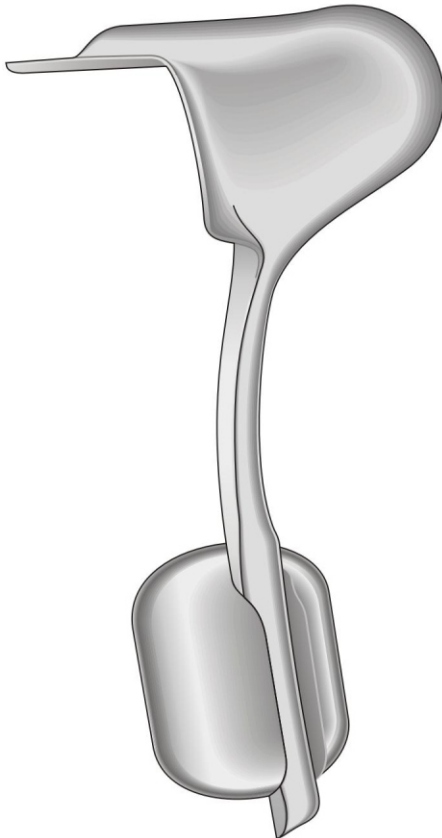

AUVARD  
HS-4666  
230 mm

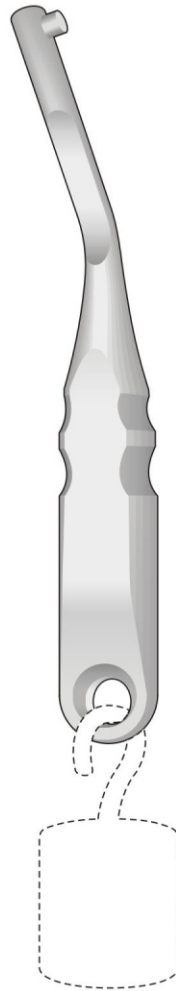

SCHERBAK  
HS-4667  
200 mm

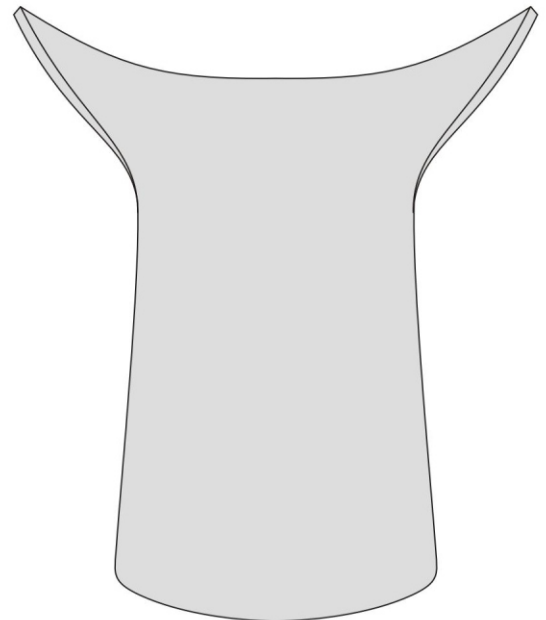

HS-4668-1  
81x45 - 70 mm

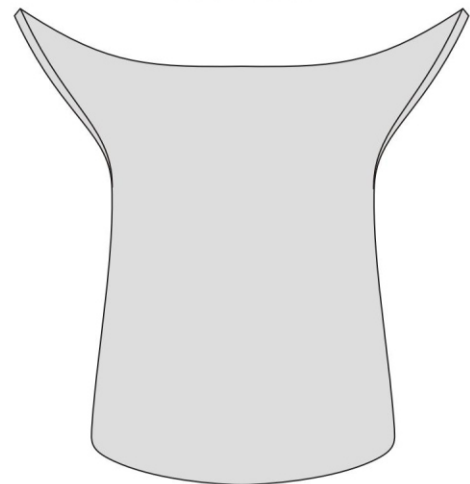

HS-4668  
62x40 - 60 mm

Geschwärzt  
Surface Black-finish  
Superficie anti-riflesso  
Surface noircie



HS-4673  
75 x 20 mm



HS-4671  
100 x 22 mm



HS-4672  
120 x 25 mm

HS-4680

Komplettset mit 14 Uterusdilatoren ohne metalletui  
Set con 14 dilatatori uterini senza scatola

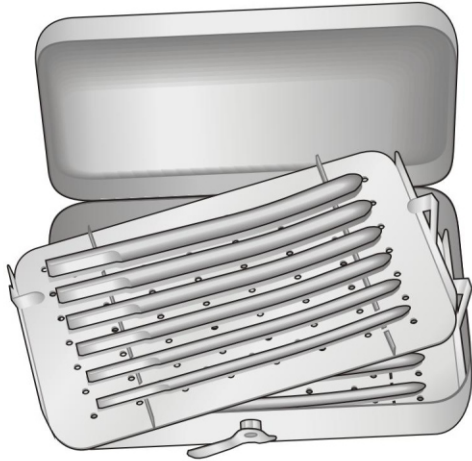

HS-4681

Komplettset mit 26 Uterusdilatoren ohne metalletui  
Set con 26 dilatatori uterini senza scatola

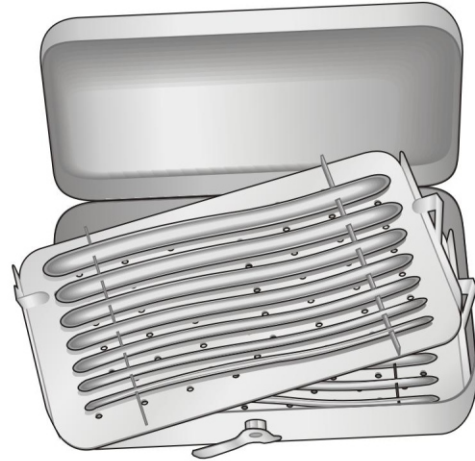

HS-4678

Metalletui mit 14 Hegar Uterusdilatoren  
Scatola con 14 dilatatori uterini Hegar



HS-4679

Metalletui mit 13 Hegar Uterusdilatoren  
Scatola con 13 dilatatori uterini Hegar



HS-4676  
mit 8 Uterusdilatoren  
con 8 dilatatori uterini



HS-4677  
für 8 Uterusdilatoren  
per 8 dilatatori uterini

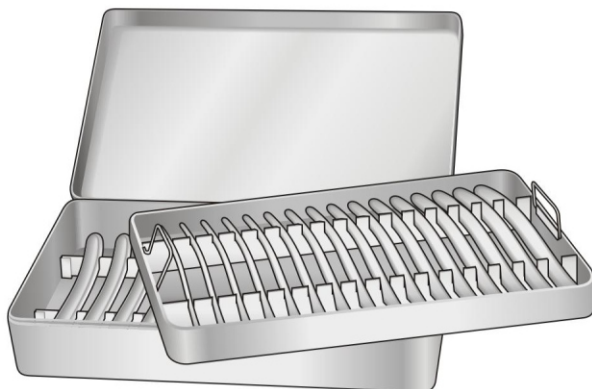

HS-4674

Metalletui mit 26 Hegar Uterusdilatoren  
Scatola con 26 dilatatori uterini Hegar

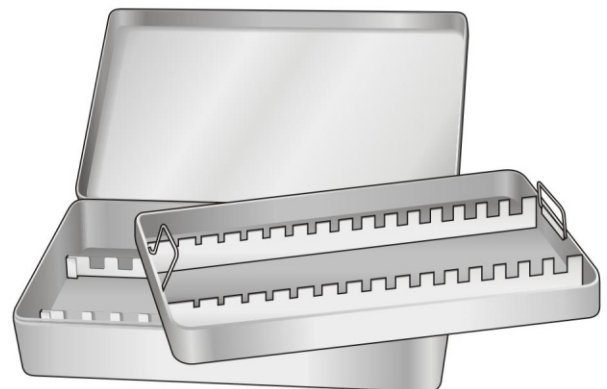

HS-4675

Metalletui leer für 26 Hegar Uterusdilatoren  
Scatola vuota per 26 dilatatori uterini Hegar





Uterusdepressor  
Uterine Depressor  
Depressore uterino  
Depresor uterino  
Dépresseur utérin



BRAUN  
HS-4682  
275 mm

Sterilisierzangen zum Fassen und Halten Steriler Instrumente  
Sterilizing forceps for picking up and holding of sterile instruments  
Pinze per prelevare strumenti sterilizzati  
Pinzas para esterilizaciòn  
Pinces pour instruments stérilisés

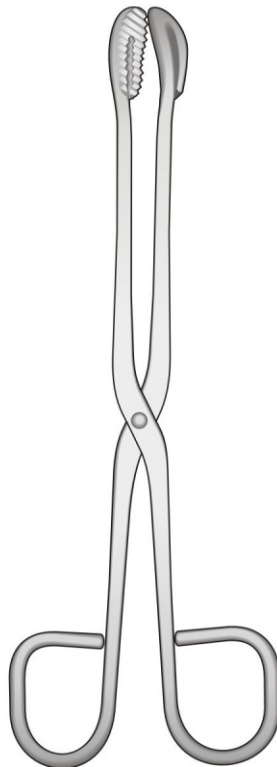

HS-4683 200 mm  
HS-4683 300 mm

Pinza per rimozione punti metallici

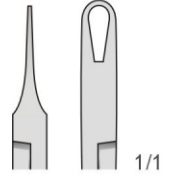
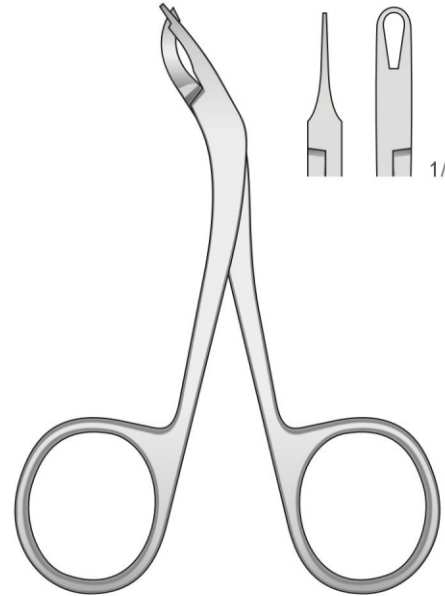

1/1

HS-4685  
115 mm

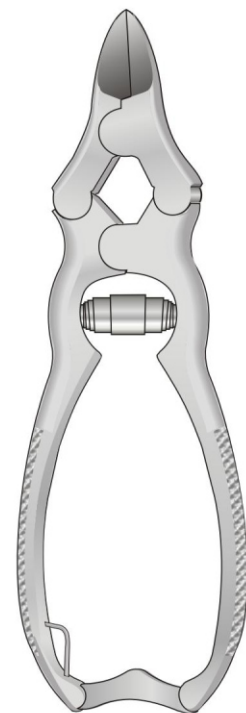

1/1

HS-4684  
155 mm



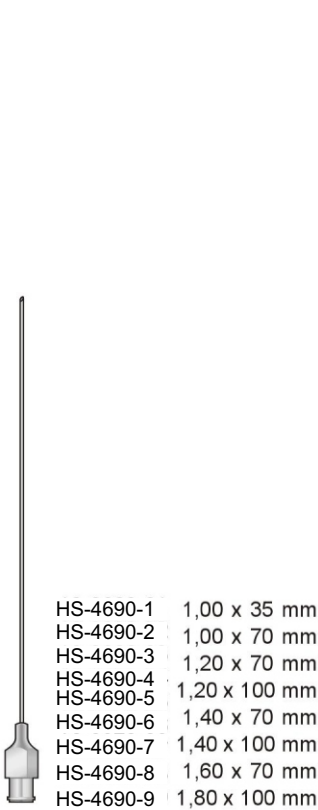

MENGHINI  
HS-4690

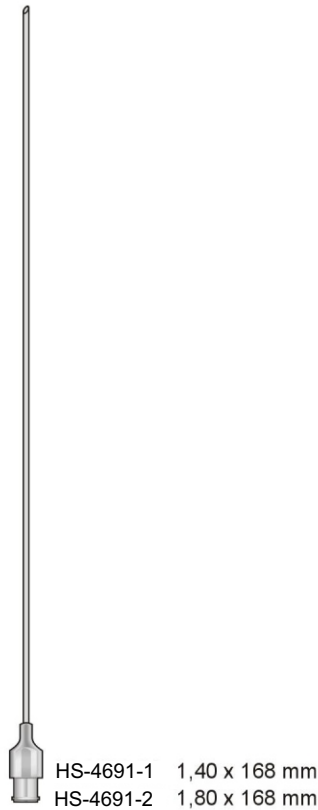

MENGHINI  
HS-4691

Kanüle mit Trokardon  
Trokar with mandrin  
Cannula completa di mandrino  
Canula con sonda de guida

Ø 4 mm  
Ø Est. 5 mm  
Ø Int. 4 mm

Silber

Saugkanüle, isoliert  
mit Saugunterbrecher und Mandrin  
Suction cannula, insulated  
with finger cut-off and stylet

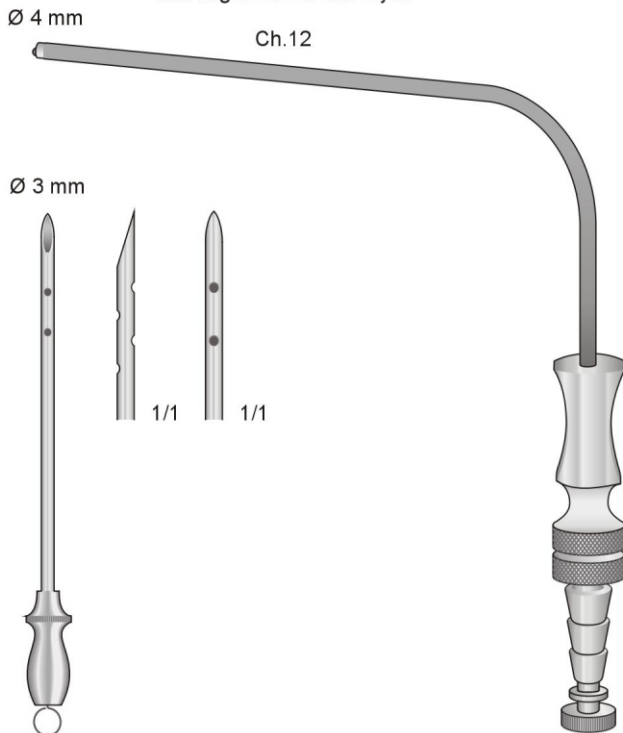

GILMET  
HS-4686  
85 mm

FERGUSON  
HS-4687  
150 mm

SEIFFERT  
HS-4688  
180 mm

HS-4689  
200 mm

- Ø 1,5 mm
- Ø 1,7 mm
- Ø 2,0 mm



- HS-4696 Ø 1,5 mm
- HS-4696 Ø 1,7 mm
- HS-4696 Ø 2,0 mm

BARNES  
HS-4696  
100 mm

- Ø 1,0 mm
- Ø 1,5 mm

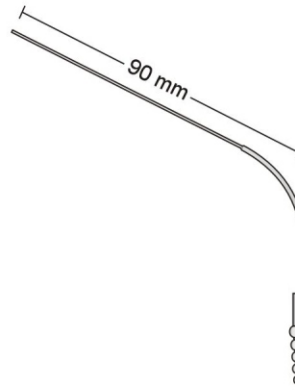

- HS-4697-1 Ø 1,0 mm
- HS-4697-2 Ø 1,5 mm

BARNES  
HS-4697  
125 mm

- Ø 2,0 mm

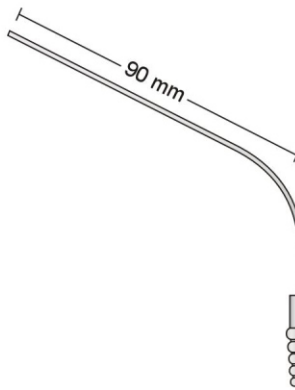

- Ø 3,0 mm
- Ø 4,0 mm
- Ø 5,0 mm

- HS-4694-1 Ø 2,0 mm

BARNES  
HS-4694  
125 mm

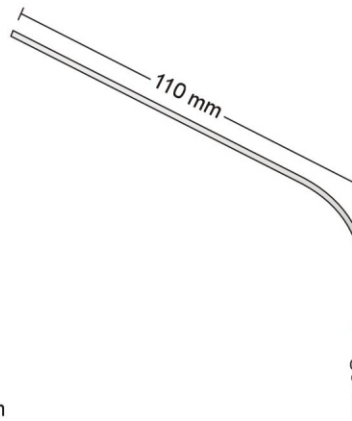

- HS-4695-1 Ø 3,0 mm
- HS-4695-2 Ø 4,0 mm
- HS-4695-3 Ø 5,0 mm

BARNES  
HS-4695  
150 mm

Ø 3.5 mm

Ø 2.0 mm

- HS-4693-1 Ø 2.0 mm / 3.5 mm  
350 mm
- HS-4693-2 Ø 2.0 mm / 3.5 mm  
500 mm

Olive  
Ø 9 mm  
HS-4693

250 mm

- HS-4692-1 Ø 2.0 mm
- HS-4692-1 Ø 2.5 mm
- HS-4692-1 Ø 3.0 mm

Olive  
Ø 6-9 mm

HS-4692  
250 mm

Lunghezza Cannula	No.1 0,6 x 0,4	No.2 0,8 x 0,6	No.3 1,0 x 0,8	No.4 1,2 x 1,0	No.5 1,5 x 1,2	No.6 2,0 x 1,6	
SS = 80 mm	HS-4698-1	HS-4698-2	HS-4698-3	HS-4698-4	HS-4698-5	HS-4698-6	For Bypass
S = 100 mm	HS-4699-1	HS-4699-2	HS-4699-3	HS-4699-4	HS-4699-5	HS-4699-6	
M = 120 mm	HS-4700-1	HS-4700-2	HS-4700-3	HS-4700-4	HS-4700-5	HS-4700-6	
L = 145 mm	HS-4701-1	HS-4701-2	HS-4701-3	HS-4701-4	HS-4701-5	HS-4701-6	
LL = 160 mm	HS-4702-1	HS-4702-2	HS-4702-3	HS-4702-4	HS-4702-5	HS-4702-6	For Trans-sphenoidal
LLL = 175 mm	HS-4703-1	HS-4703-2	HS-4703-3	HS-4698-4	HS-4703-5	HS-4703-6	For Trans-sphenoidal

Char. 1 = 0,3 mm
Char. 2 = 0,6 mm
Char. 3 = 1,0 mm
Char. 4 = 1,3 mm
Char. 5 = 1,6 mm
Char. 6 = 2,0 mm
Char. 7 = 2,3 mm
Char. 8 = 2,6 mm
Char. 9 = 3,0 mm
Char. 10 = 3,3 mm

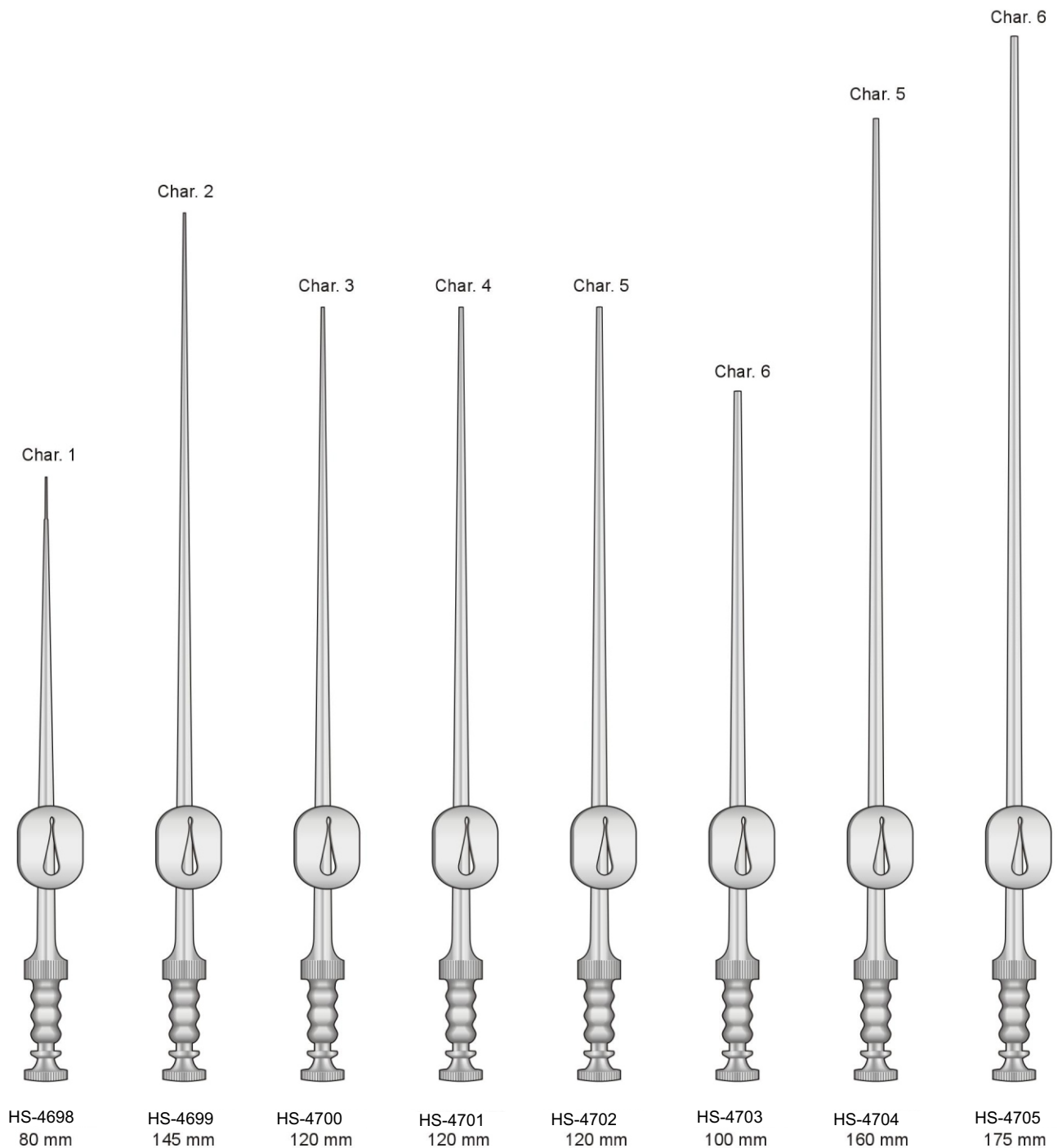

HS-4713

Lunghezza Cannula	No.7 2,5 x 1,9	No.8 3,0 x 2,2	No.9 3,5 x 2,5	No.10 4,0 x 3,0	
M = 120 mm	HS-4706-1	HS-4706-2	HS-4706-3	HS-4706-4	
L = 145 mm	HS-4707-1	HS-4707-2	HS-4707-3	HS-4707-4	
LL = 160 mm	HS-4708-1	HS-4708-2	HS-4708-3	HS-4708-4	For Trans-sphenoidal
LLL = 175 mm	HS-4709-1	HS-4709-2	HS-4709-3	HS-4709-4	For Trans-sphenoidal

Char. 1	= 0,3 mm
Char. 2	= 0,6 mm
Char. 3	= 1,0 mm
Char. 4	= 1,3 mm
Char. 5	= 1,6 mm
Char. 6	= 2,0 mm
Char. 7	= 2,3 mm
Char. 8	= 2,6 mm
Char. 9	= 3,0 mm
Char. 10	= 3,3 mm

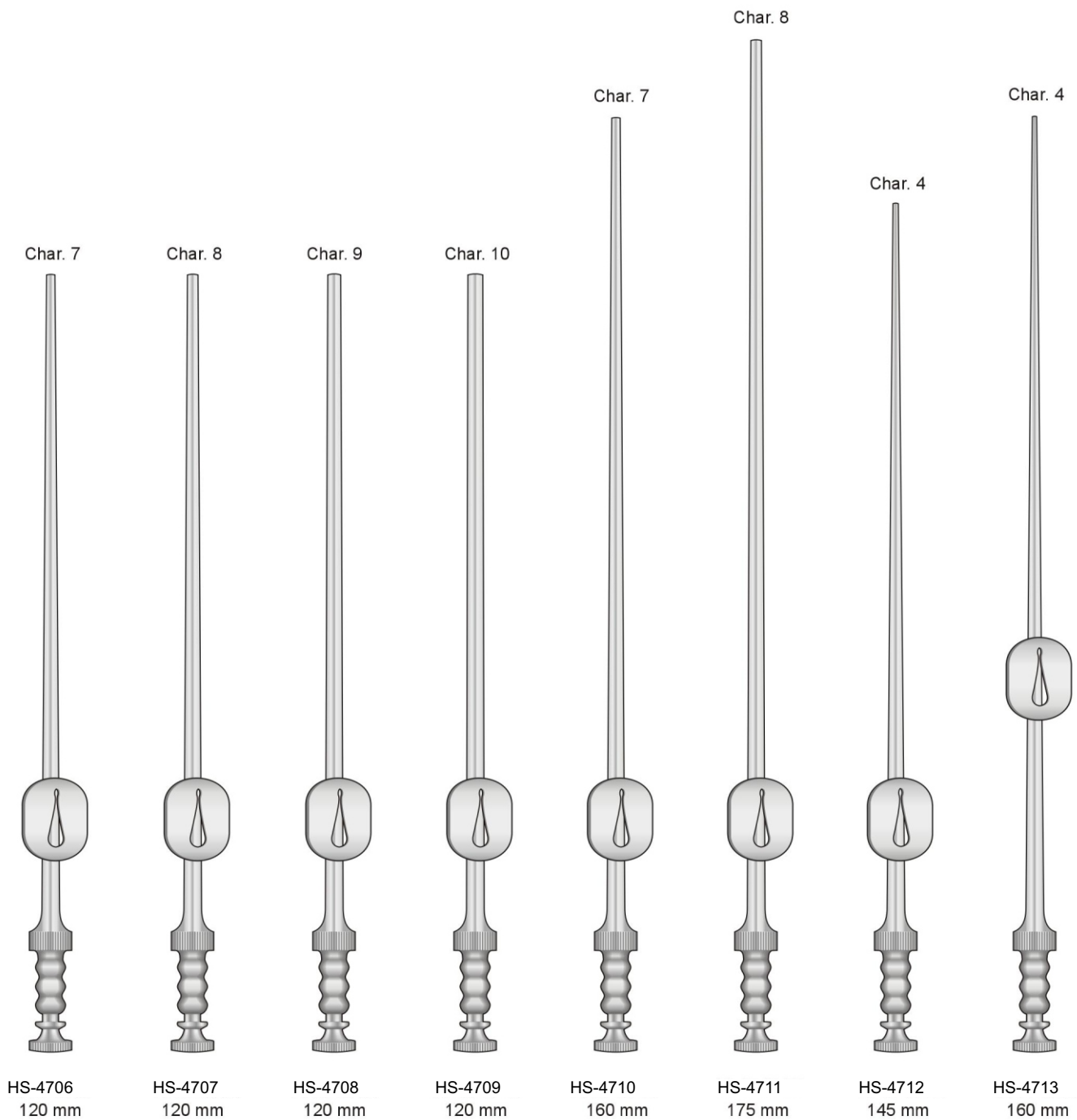

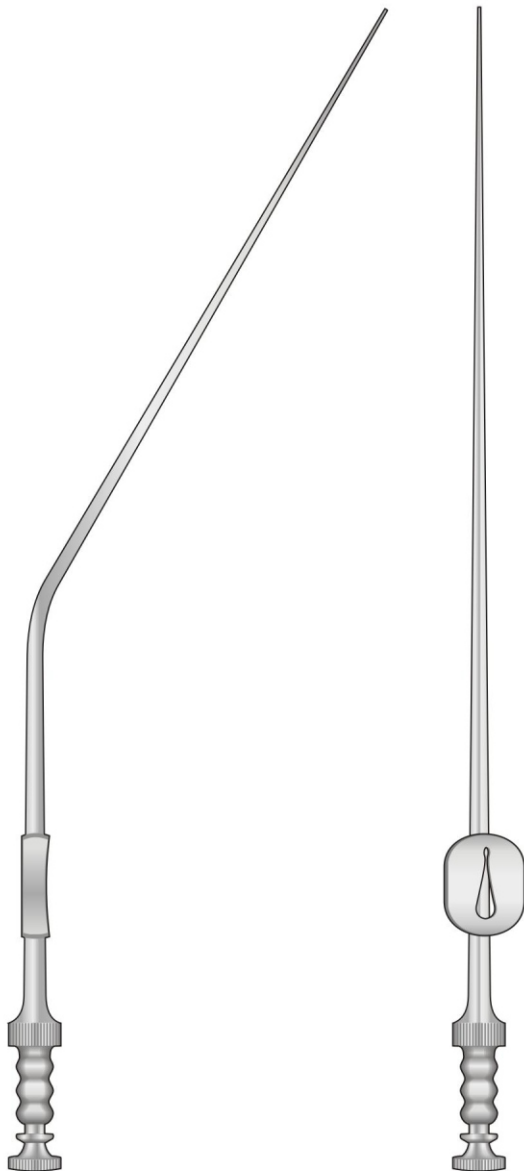

Char. 3	= 1,0 mm
Char. 4	= 1,3 mm
Char. 5	= 1,6 mm
Char. 6	= 2,0 mm
Char. 7	= 2,3 mm
Char. 8	= 2,6 mm
Char. 9	= 3,0 mm
Char. 10	= 3,3 mm
Char. 11	= 3,6 mm
Char. 12	= 4,0 mm

	Lunghezza 160 mm	Lunghezza 180 mm	Lunghezza 205 mm
Char. 3	HS-4714-1	HS-4714-11	HS-4714-21
Char. 4	HS-4714-2	HS-4714-12	HS-4714-22
Char. 5	HS-4714-3	HS-4714-13	HS-4714-23
Char. 6	HS-4714-4	HS-4714-14	HS-4714-24
Char. 7	HS-4714-5	HS-4714-15	HS-4714-25
Char. 8	HS-4714-6	HS-4714-16	HS-4714-26
Char. 9	HS-4714-7	HS-4714-17	HS-4714-27
Char. 10	HS-4714-8	HS-4714-18	HS-4714-28
Char. 11	HS-4714-9	HS-4714-19	HS-4714-29
Char. 12	HS-4714-10	HS-4714-20	HS-4714-30

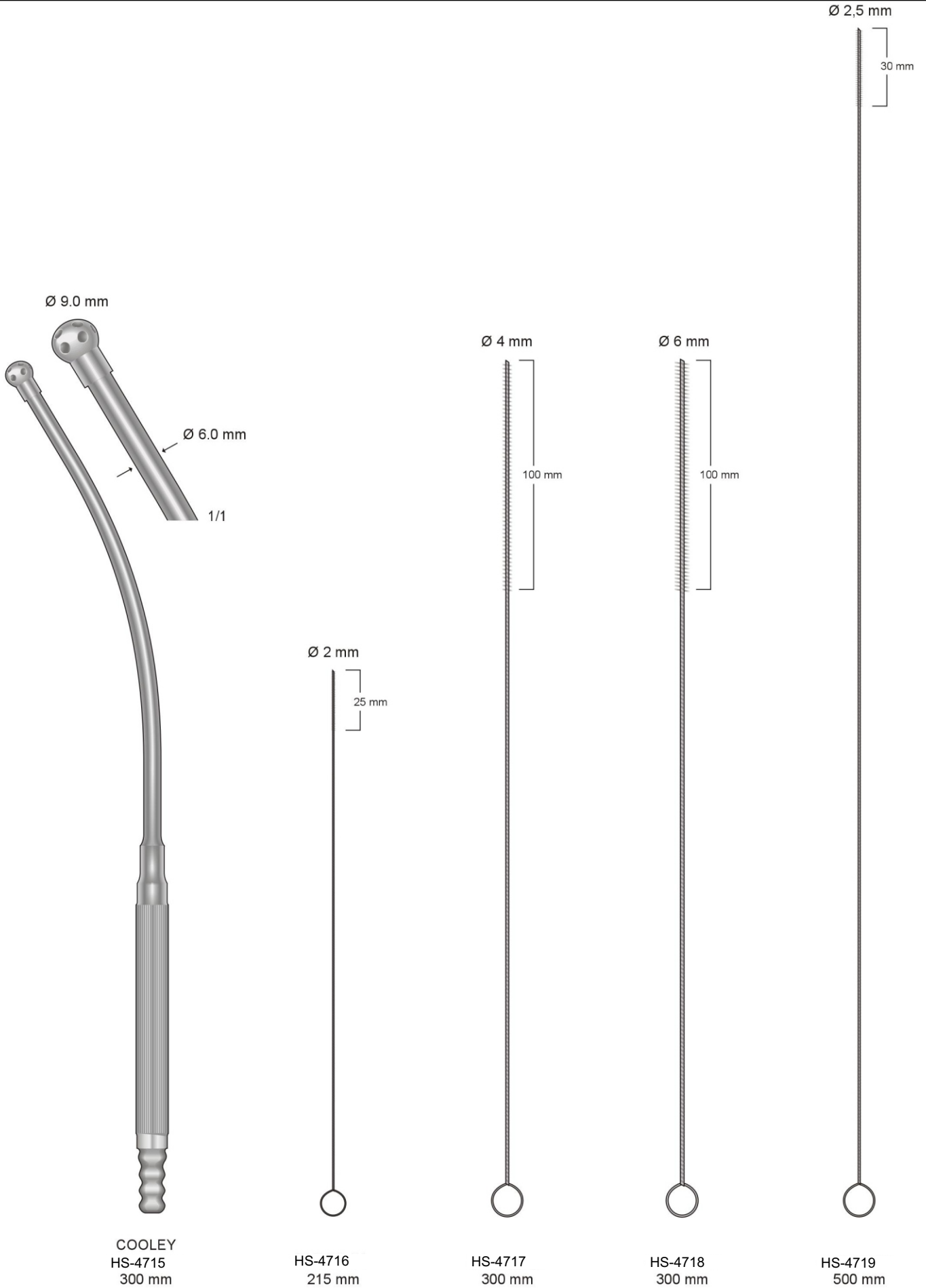



*Post Mortem Knives*

mm: Schnittlänge  
Lenght of blades  
Lunghezza della lama  
Largo de hojas  
Longueur de la lame

Metallheft  
Metal handle  
Manico in metallo  
Mango metálico  
Manche métal

Holzheft  
Wooden handle  
Manico in legno  
Mango de madera  
Manche bois

Metallheft  
Metal handle  
Manico in metallo  
Mango metálico  
Manche métal

Metallheft  
Metal handle  
Manico in metallo  
Mango metálico  
Manche métal

Resektionsmesser  
Resection knives  
Coltello per resezione  
Cuchillos para resección  
Couteaux à résection

Organmesser  
Post mortem knives  
Coltello per autopsia  
Cuchillos para órganos  
Couteaux à autopsie

Organmesser  
Post mortem knives  
Coltello per autopsia  
Cuchillos para órganos  
Couteaux à autopsie

Hirnmesser  
Brain knives  
Coltello per cervello  
Cuchillos para cerebro  
Couteaux à cerveau

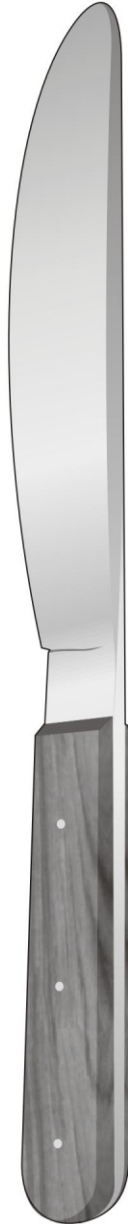
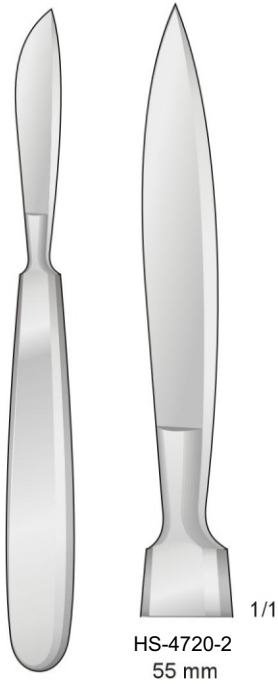
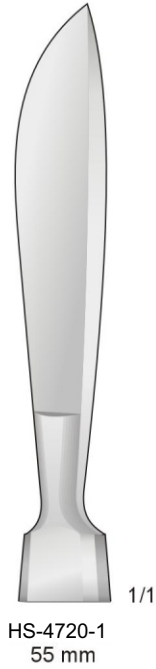

LANGENBECK  
HS-4720  
55 mm

HS-4721  
110 mm

HS-4722  
170 mm

HS-4723  
195 mm

VIRCHOW  
HS-4724  
160 mm

VIRCHOW  
HS-4725  
200 mm

VIRCHOW  
HS-4726  
240 mm



Dermatome komplett mit 1 auswechselbarer Klinge und 2 Spannplatten  
 Dermatome complete with 1 interchangeable blade and 2 skin plates  
 Dermatomo a mano, con una lama intercambiabile, completo di 2 placche per stendere la pelle  
 Dermatomo completo, con 1 hoja intercambiabile y 2 placas para extender la piel  
 Dermatome avec 1 lame interchangeable et 2 plaques pour tendre la peau

Einstellbar von 0,1 bis 3,0 mm  
 Adjustable from 0,1 to 3,0 mm  
 Regolazione da 0,1 a 3,0 mm  
 Regulable de 0,1 hasta 3,0 mm  
 Réglable en épaisseur de 0,1 à 3,0 mm

Einstellbar von 0,1 bis 4,0 mm  
 Adjustable from 0,1 to 4,0 mm  
 Regolazione da 0,1 a 4,0 mm  
 Regulable de 0,1 hasta 4,0 mm  
 Réglable en épaisseur de 0,1 à 4,0 mm

Für handelsübliche Rasierklingen  
 For usual razor blades  
 Per lamette standard  
 Para hojas de afeitar usuales  
 Pour lames de rasoir modèle standard

Spanplatte  
 Skin Fixing Plate  
 Placca per stendere la pelle  
 Placa para extender la piel  
 Plaque pour tendre la peau



SCHINK  
HS-4727



SILVER  
HS-4728  
190 mm

Ersatzklinge, allein  
 Spare Blade only  
 Lama di ricambio sola  
 Hoja de repuesto  
 Lame de rechange, seule



SILVER  
HS-4729  
43 mm

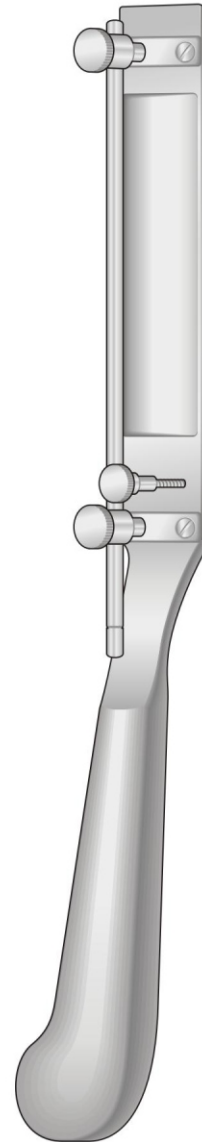

SCHINK  
HS-4730  
300 mm

Ersatzklinge, allein  
 Spare Blade only  
 Lama di ricambio sola  
 Hoja de repuesto  
 Lame de rechange, seule



SCHINK  
HS-4731  
102 mm

Dermatome komplett mit 1 auswechselbarer Klinge und 2 Spannplatten

Dermatome complete with 1 interchangeable blade and 2 skin plates

Dermatomo a mano, con una lama intercambiabile, completo di 2 placche per stendere la pelle

Dermatomo completo, con 1 hoja intercambiabile y 2 placas para extender la piel

Dermatome avec 1 lame interchangeable et 2 plaques pour tendre la peau

Einstellbar von 0,1 bis 1,5 mm

Adjustable from 0,1 to 1,5 mm

Regolazione da 0,1 a 1,5 mm

Regulable de 0,1 hasta 1,5 mm

Réglable en épaisseur de 0,1 à 1,5 mm

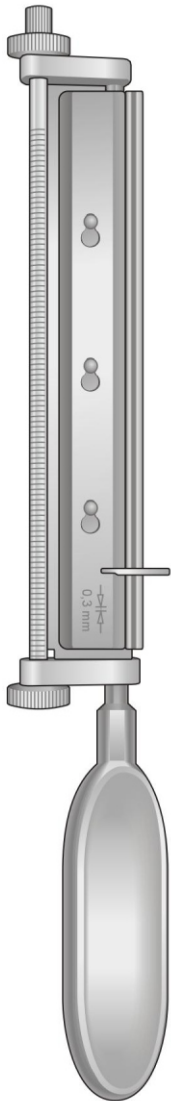

WATSON  
HS-4732  
300 mm

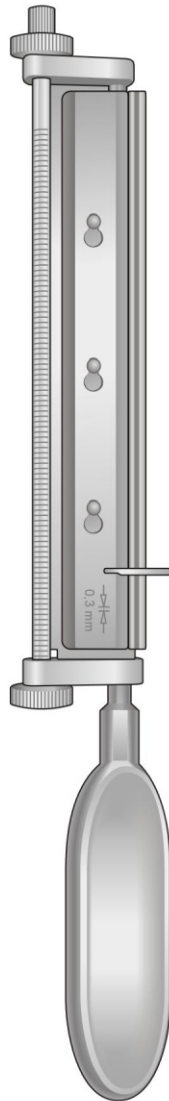

COBBETT  
HS-4733  
300 mm

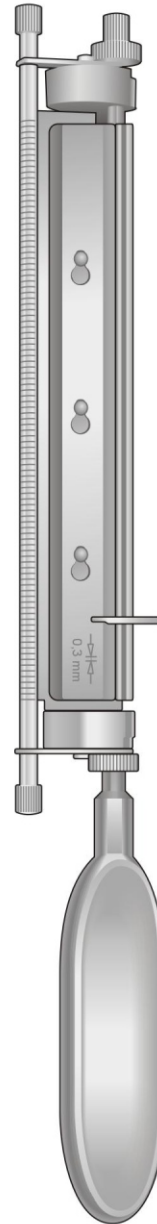

HUMBY  
HS-4734  
320 mm

Ersatzklinge, allein  
Spare Blade only  
Lama di ricambio sola  
Hoja de repuesto  
Lame de rechange, seule



HUMBY  
HS-4735  
157 mm

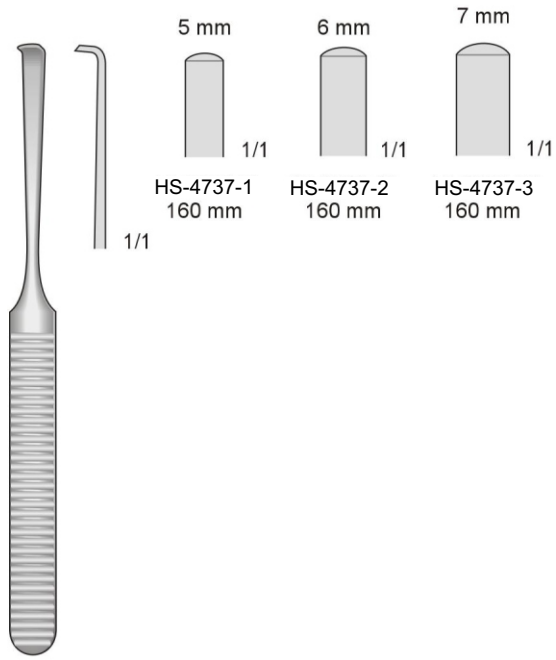

HS-4737  
 160 mm

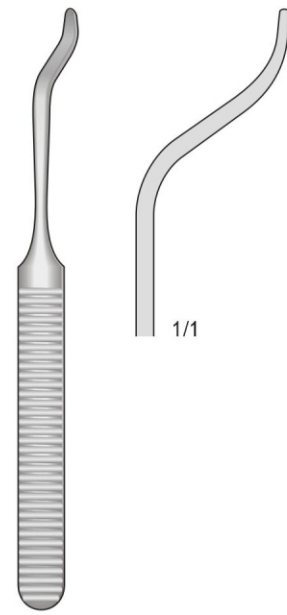

HS-4738  
 160 mm

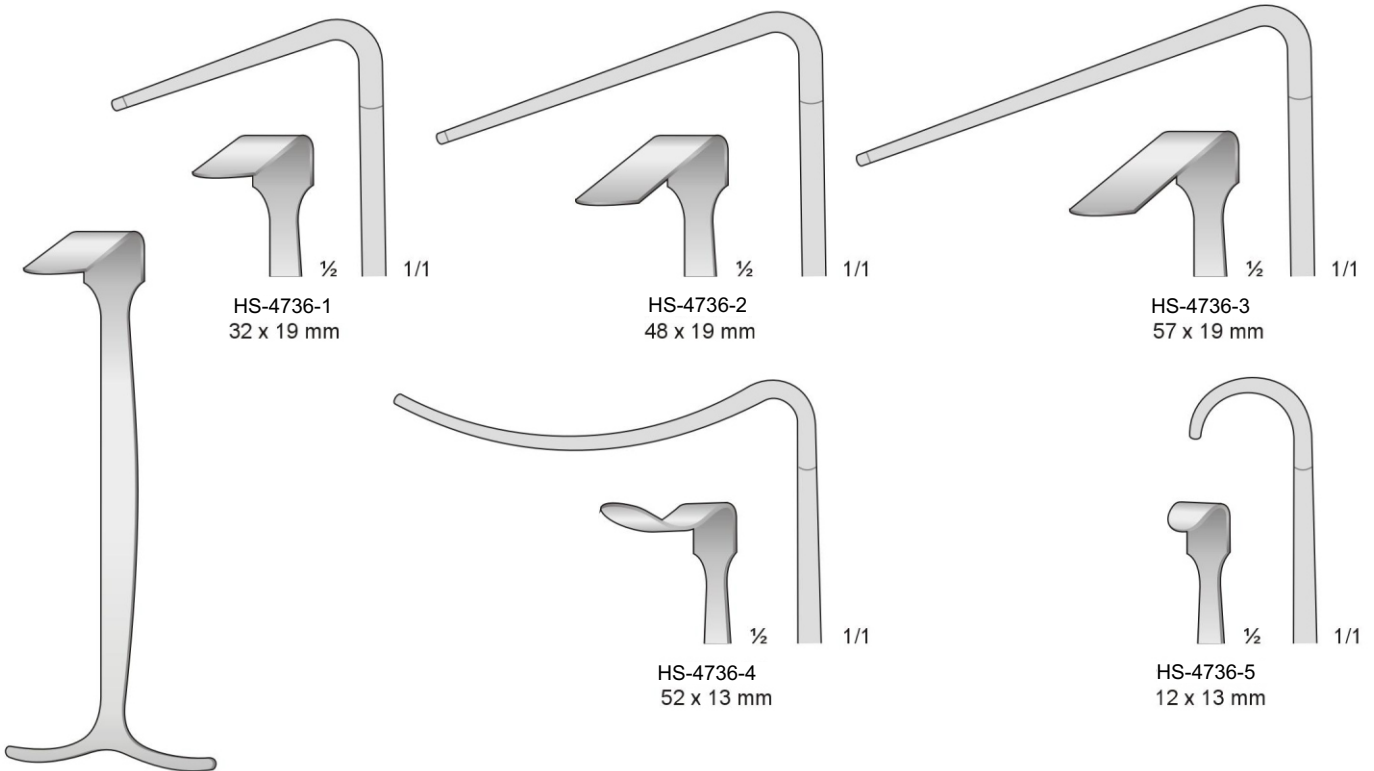

SMILLIE  
 HS-4736  
 140 mm

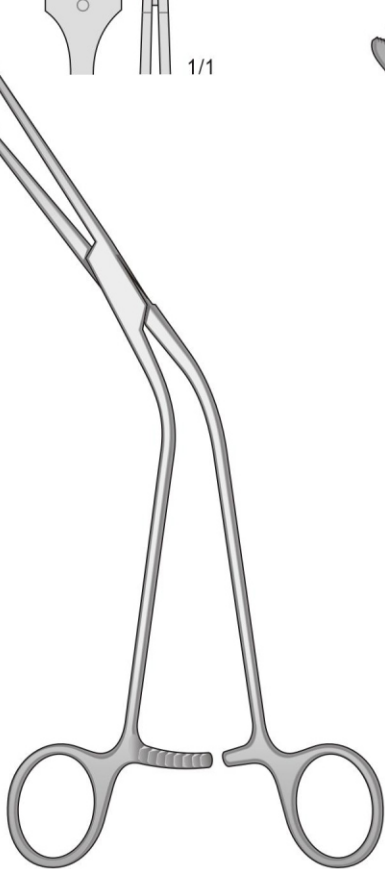
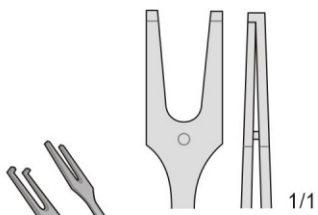

MILLIN  
HS-4739  
245 mm

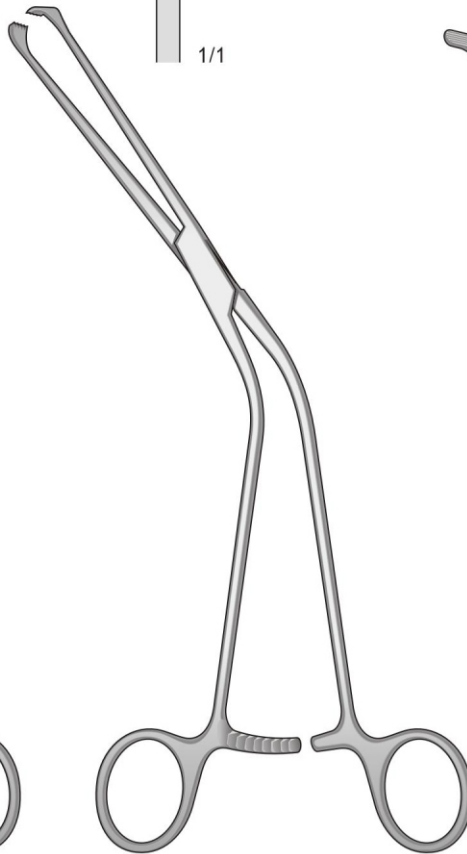
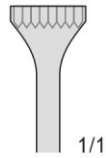

MILLIN  
HS-4740  
220 mm

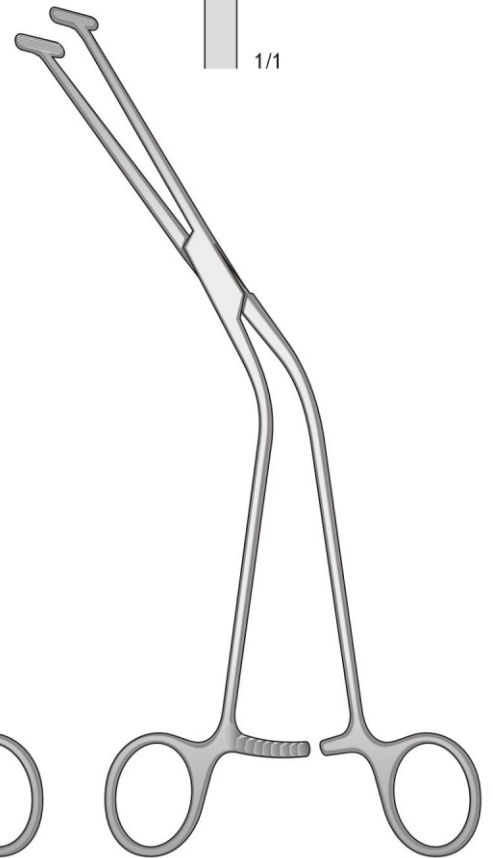
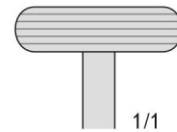

MILLIN  
HS-4741  
245 mm



Atraumatische - Atraumatic  
Atraumatiche - Atraumáticas  
Atraumatiques

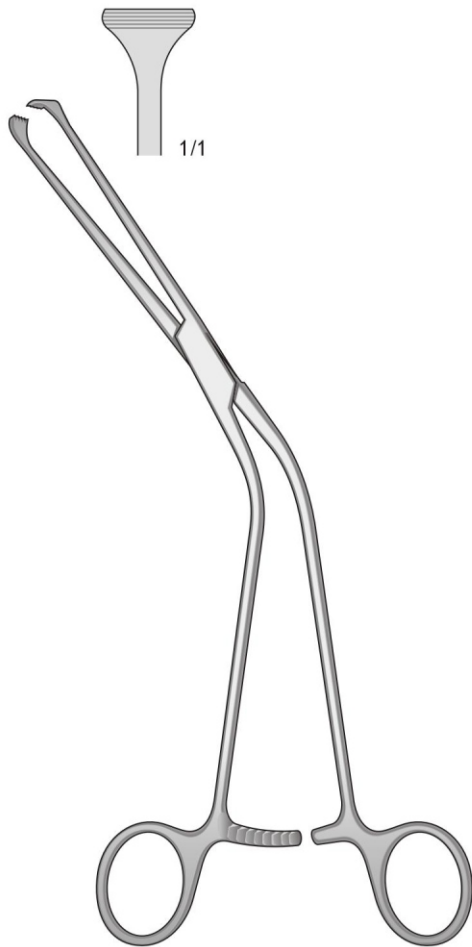

MILLIN  
HS-4742  
220 mm

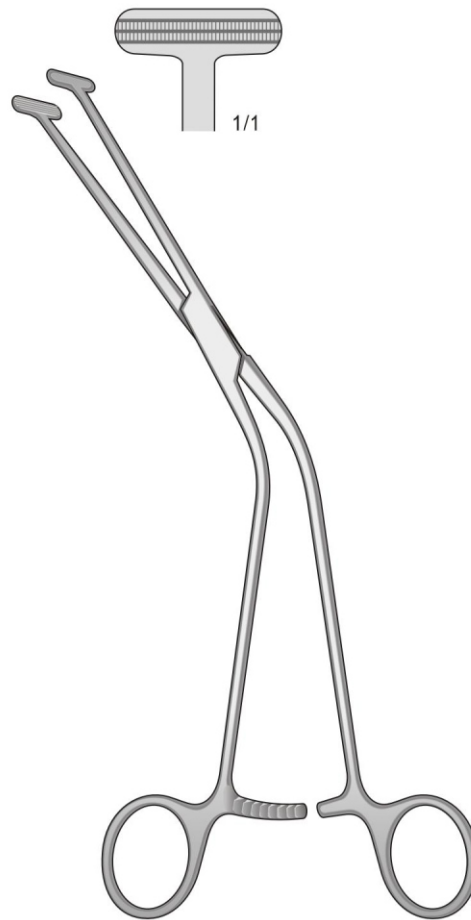

MILLIN  
HS-4743  
245 mm

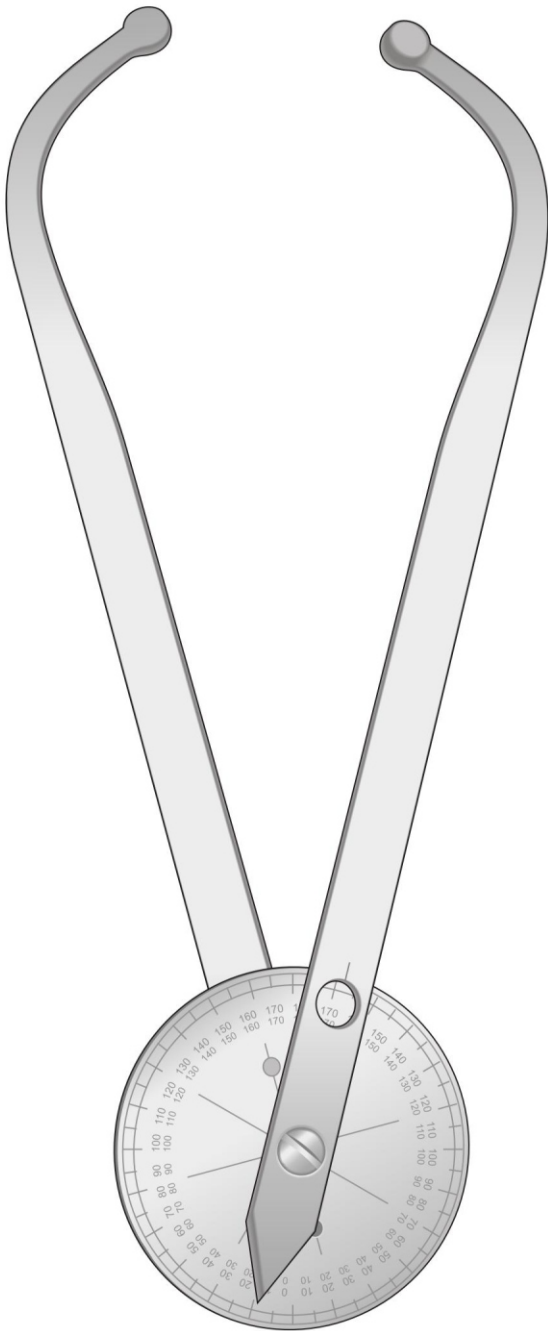

HS-4744  
240 mm

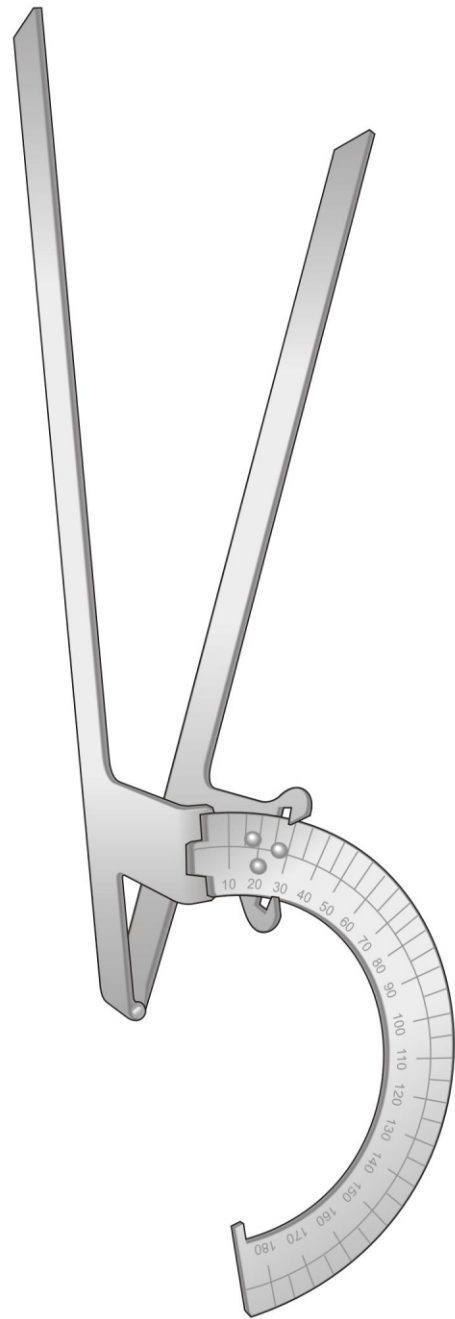

HS-4745  
235 mm



**Manufacturer & Exporter  
Of Surgical, Dental & Beauty Instruments.**



# Health Fast Surgical

Surgical Manufacturer Company

+92 (342) 880 9017

+92 (342) 880 9017

info@healthfastsurgical.com

www.healthfastsurgical.com

Dogra Khurd, P.O Harrar Sialkot-51310 Pakistan.



ISO  
9001:2008

