

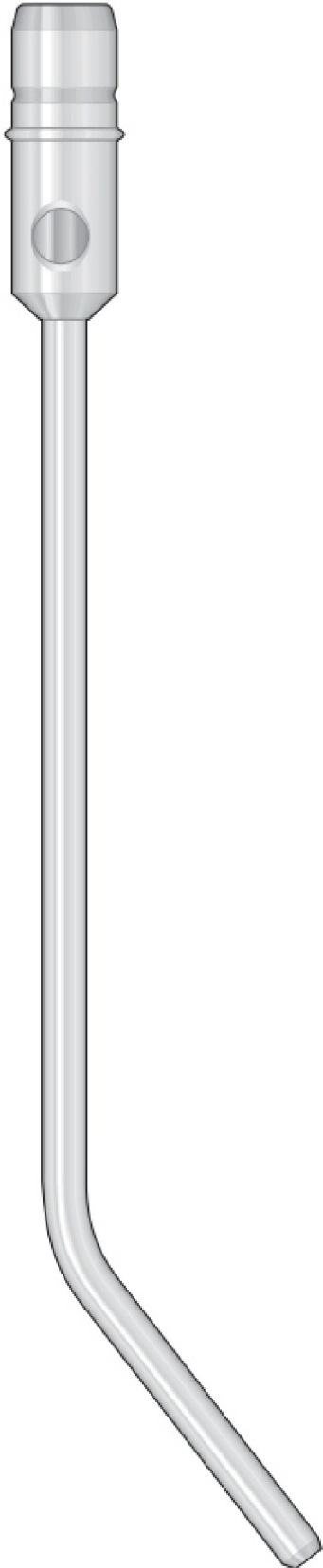

Health Fast Surgical
Surgical Manufacturer Company



ISO
9001:2008



Suction Tube

**DENTAL
INSTRUMENTS
CATALOGUE**



Saugkanülen
Suction Tubes
Cannule per aspirazione
Cánulas de aspiración
Canules d'aspiration

Stainless Steel
Rostfreier Stahl
Acier inoxydable
Acero inoxidable
Acciaio inossidabile

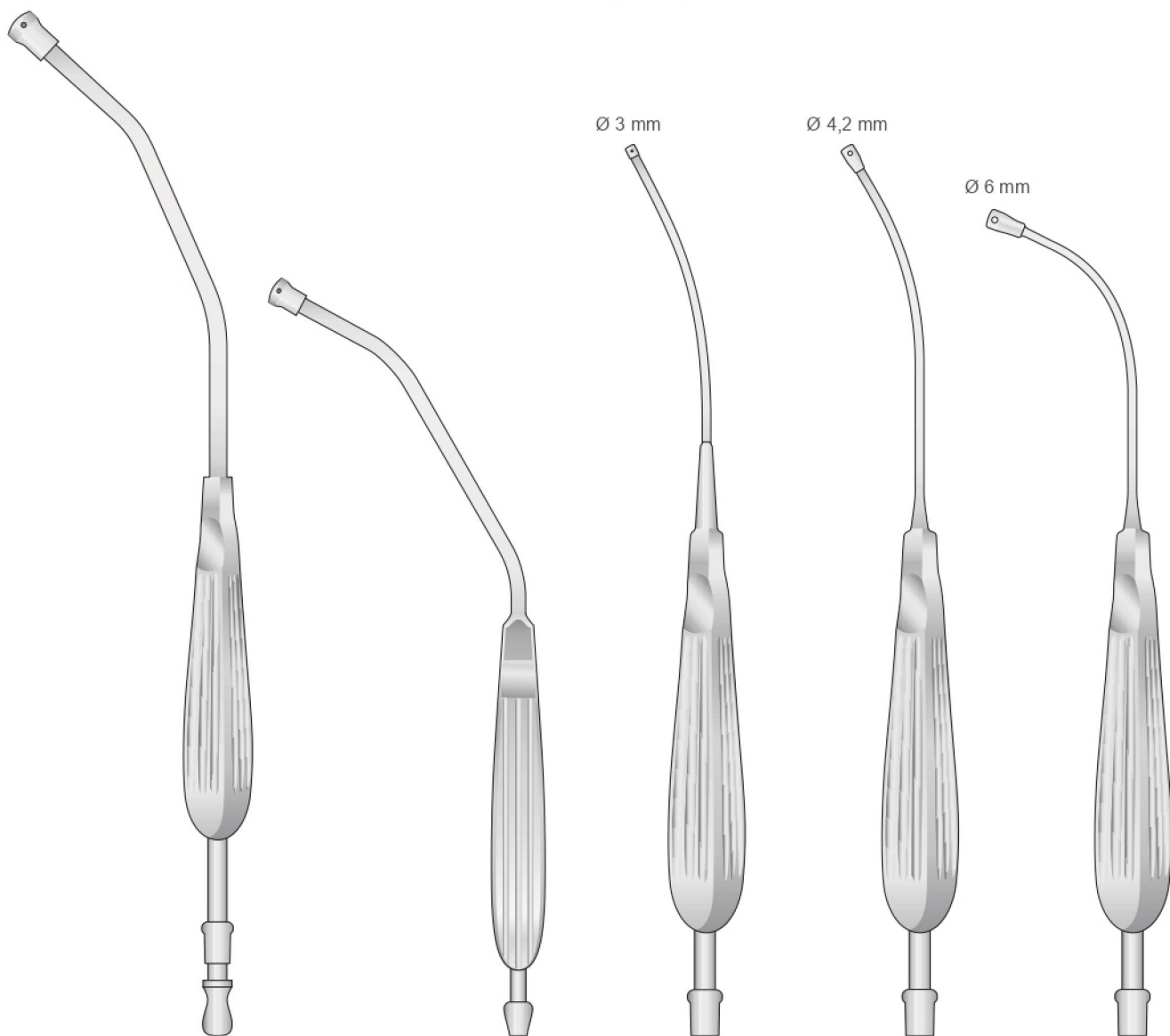

YANKAUER
DI-GF-12
310 mm

BABY-YANKAUER
DI-GF-10
200 mm

ANDREWS-PYNCHON
DI-GF-06
250 mm

ANDREWS-PYNCHON
DI-GF-07
250 mm

ANDREWS-PYNCHON
DI-GF-54
230 mm



Stainless Steel
Rostfreier Stahl
Acier inoxydable
Acero inoxidable
Acciaio inossidabile

Saugkanülen
Suction Tubes
Cannule per aspirazione
Cánulas de aspiración
Canules d'aspiration

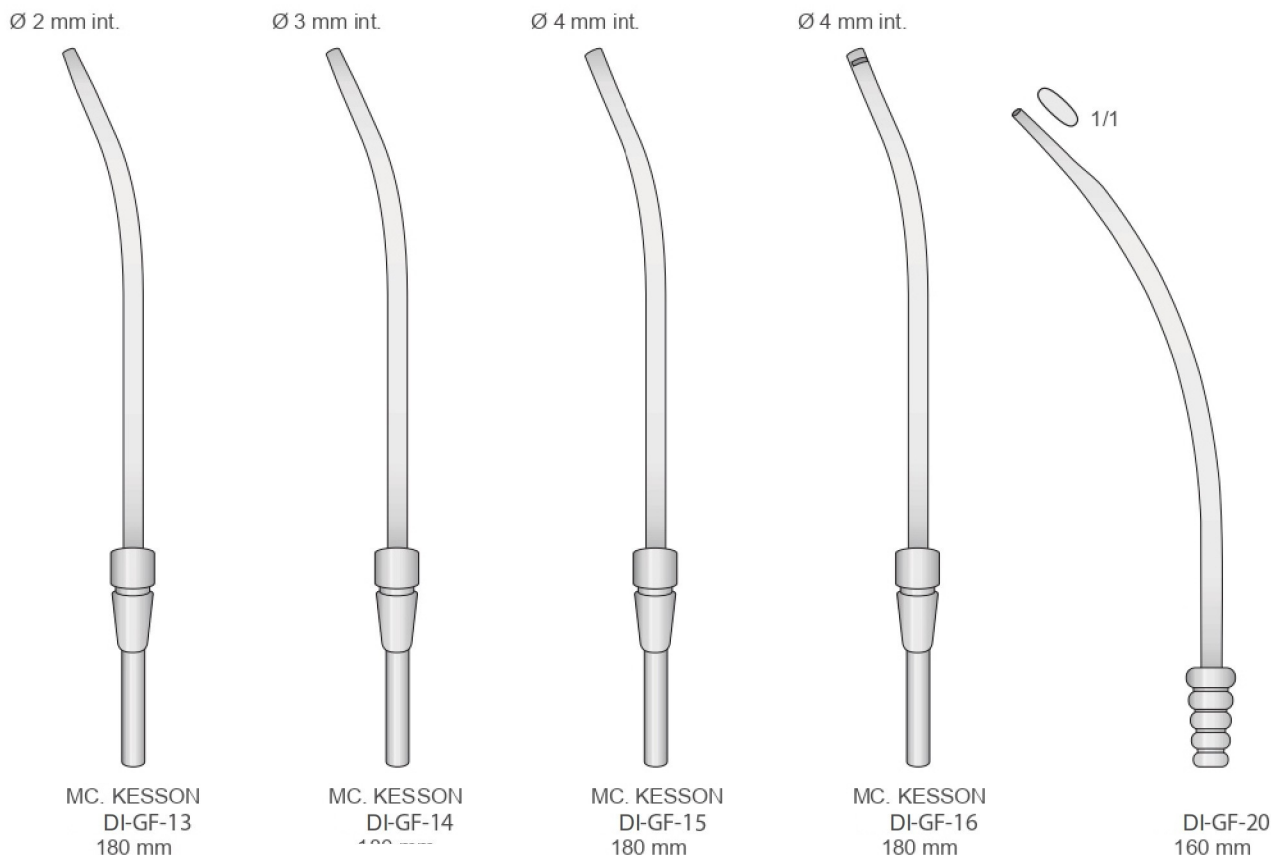
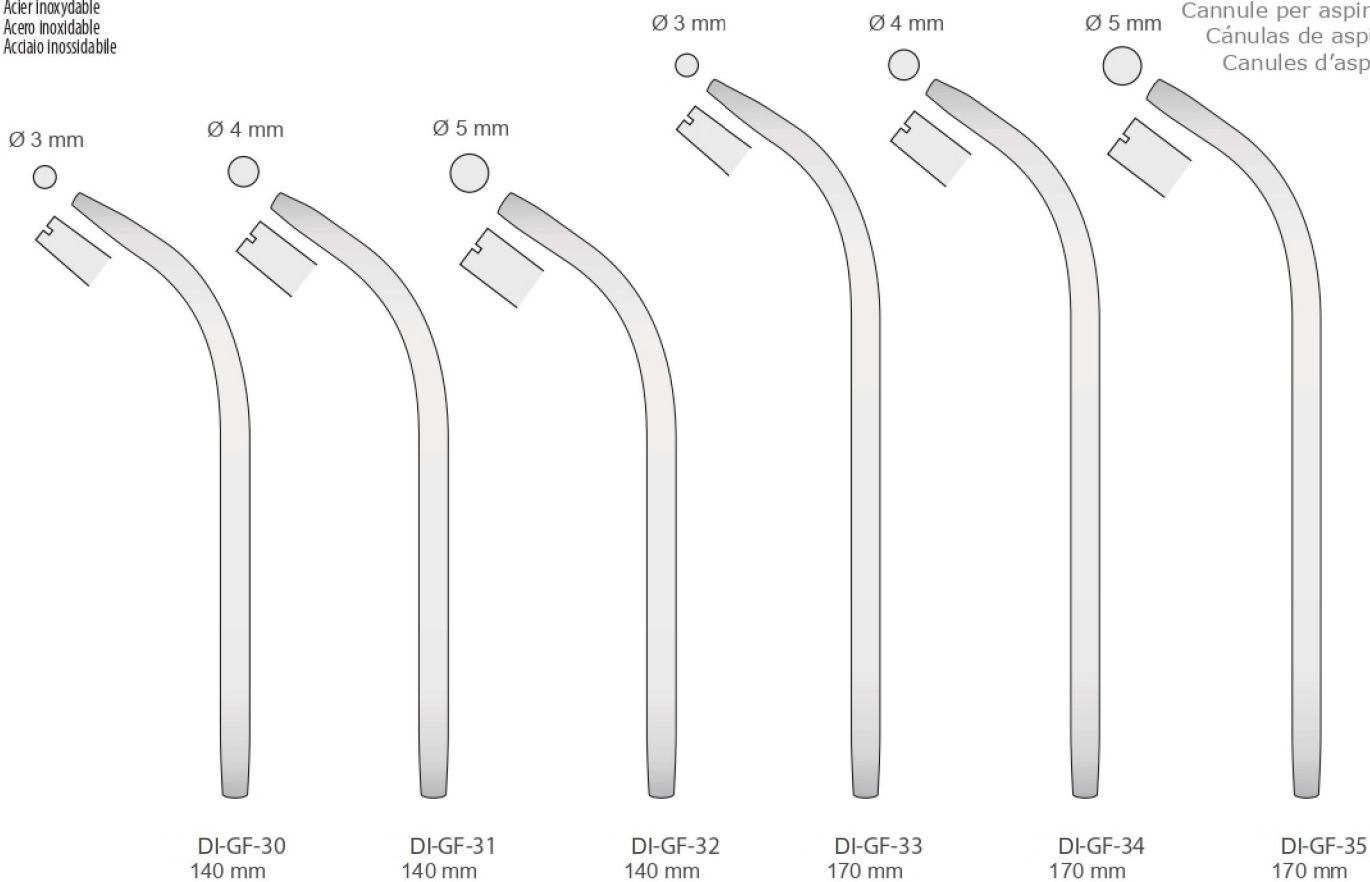



Saugkanülen
Suction Tubes
Cannule per aspirazione
Cánulas de aspiración
Canules d'aspiration

Stainless Steel
Rostfreier Stahl
Acier Inoxydable
Acero inoxidable
Acciaio inossidabile

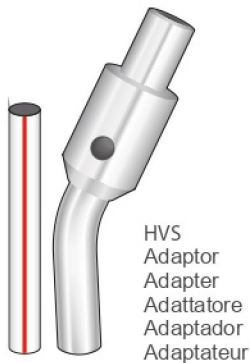

DI-TS-40
Connection piece for suction
75 mm - 100% Stainless Steel



COUPLAND
DI-GF-01
150 mm

Ø 1 mm Ø 1,5 mm Ø 2,5 mm Ø 3,5 mm int.

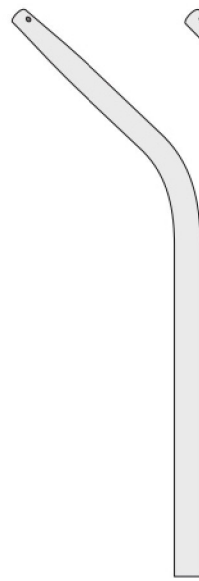

DI-GF-05
95 mm

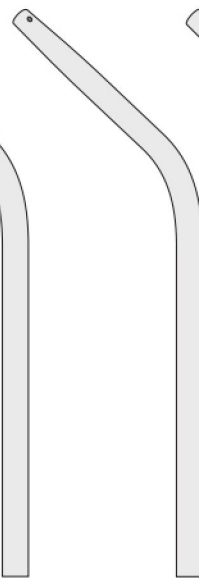

DI-GF-04
95 mm

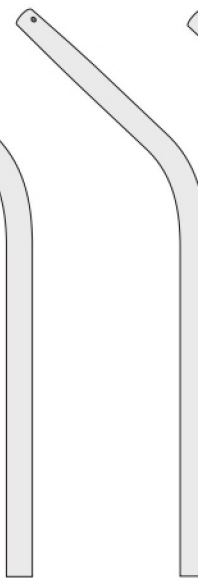

DI-GF-03
95 mm

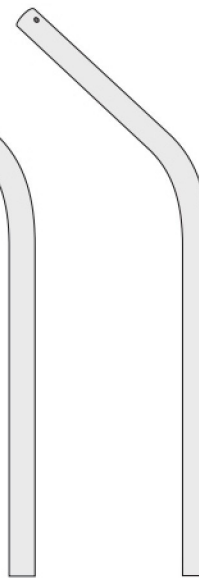

DI-GF-02
95 mm

COMPLETE SET
DI-GF-11
(DI-GF-01 + DI-GF-02 + DI-GF-03
+ DI-GF-04 + DI-GF-05)
Griff + 4 Kanülen
Handle + 4 tubes
Manico + 4 cannule
Mango + 4 cánulas
Manche + 4 canules



DI-GF-271
56 mm

Adaptor
Adapter
Adattatore
Adaptador
Adaptateur

Ø Ext. 6,0 mm
Ø Int. 4,5 mm

Autoclavable Tubing
Schlauch - Silikon
Flexible Tube - Silicone
Raccordo in silicone per cannule
Tubo flexible de silicona
Tuyau - Silicone

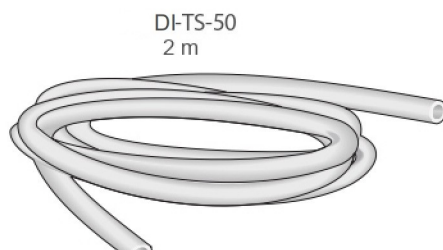

DI-TS-50
2 m



DI-GF-901
B1 Byrd
Self-Cleaning
Aspirator

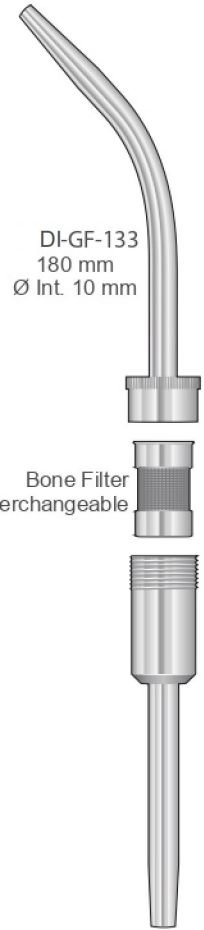

DI-GF-133
180 mm
Ø Int. 10 mm

Bone Filter
interchangeable



Saugkanülen
Suction Tubes
Cannule per aspirazione
Cánulas de aspiración
Canules d'aspiration

Stainless Steel
Rostfreier Stahl
Acier inoxydable
Acero inoxidable
Acciaio inossidabile

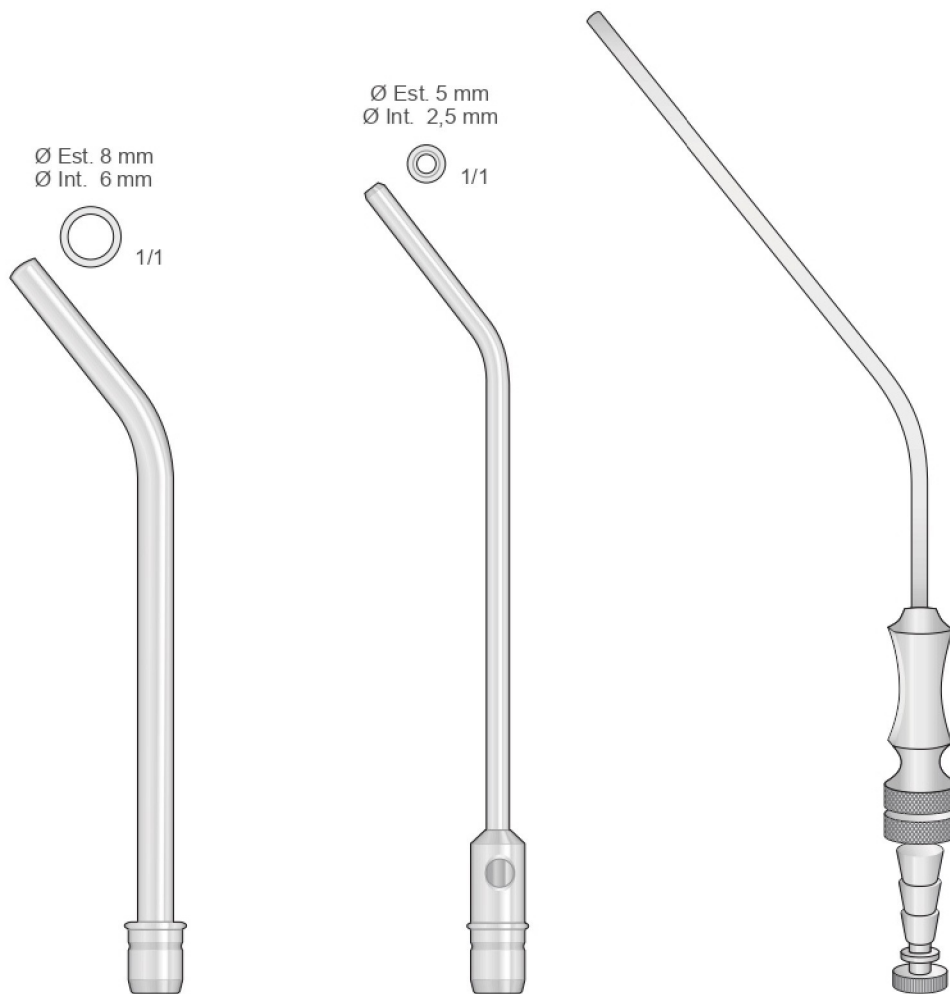

PELTON-CRANE
DI-GF-184
140 mm

PELTON-CRANE
DI-GF-180
160 mm

FRAZIER
DI-GF-240/ DI-GF-244
180 mm

DI-GF-240	Ch. 6	2.0 mm
DI-GF-241	Ch. 7	2.3 mm
DI-GF-241B	Ch. 8	2.5 mm
DI-GF-242	Ch. 9	3.0 mm
DI-GF-242B	Ch. 10	3.3 mm
DI-GF-243	Ch. 12	4.0 mm
DI-GF-244	Ch. 15	5.0 mm



Saugkanülen
Suction Tubes
Cannule per aspirazione
Cánulas de aspiración
Canules d'aspiration

Stainless Steel
Rostfreier Stahl
Acier inoxydable
Acero inoxidable
Acciaio inossidabile



Flexible
Flexibel
Flexible
Flexible
Flessibile
Ø 3 mm

WERTHEIMER
DI-GF-69
160 mm



Chromium Black
Schwarz-Chrom
Chrom noir
Cromado negro
Cromato nero

FRAZIER
DI-GF-70
160 mm

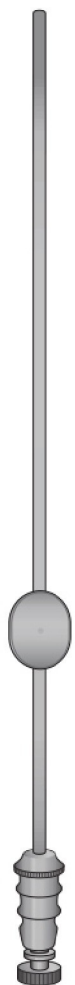

Flexible
Flexibel
Flexible
Flexible
Flessibile
Ø 3 mm

FRAZIER
DI-GF-61
200 mm



WERTHEIMER
DI-GF-60
200 mm

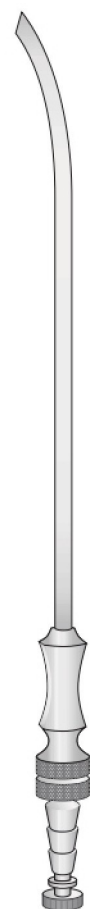

ADSON
DI-GF-41 ch. 12 Ø 4 mm
DI-GF-42 ch. 15 Ø 5 mm
210 mm



Kanülenreinigungs-Bürsten
Cleaning brush for Tubes
Scovolini per pulizia cannule
Cepillo para limpiar cánulas
Brosse de nettoyage pour canules



Bürsten
Brush
Spazzola
Cepillo
Brosse

Autoklav
Autoclavable
Autoclavabile
Autoclave
Autoclave

DI-GF-200
4 x 11 cm

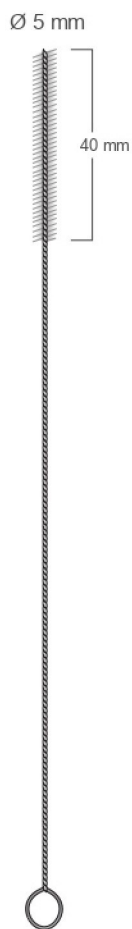

DI-GF-40
235 mm

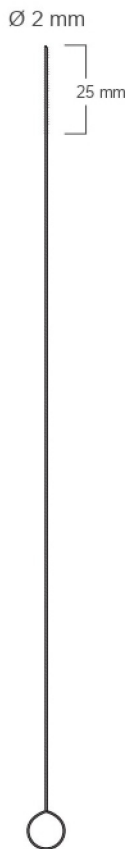

DI-GF-182
215 mm

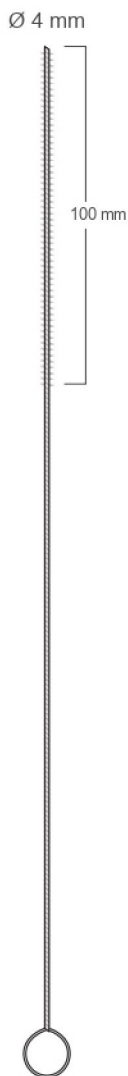

DI-GF-183
300 mm

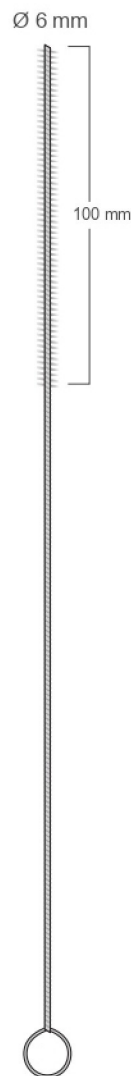

DI-GF-185
300 mm

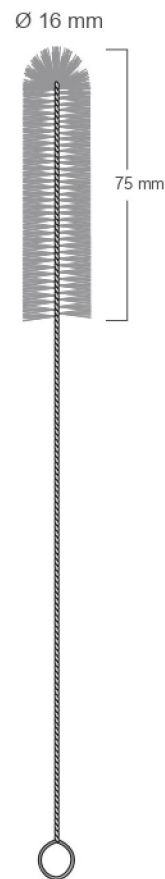

DI-GF-188
220 mm