



**Health Fast Surgical**  
Surgical Manufacturer Company



# Root Elevators

**DENTAL  
INSTRUMENTS CATALOGUE**



Wurzelheber  
Root Elevators  
Leve per radici  
Elevadores para raíces  
Elevateurs à racines

SMALL HANDLE

Luxatoren - Luxators  
Lussatori - Luxadores  
Luxateurs

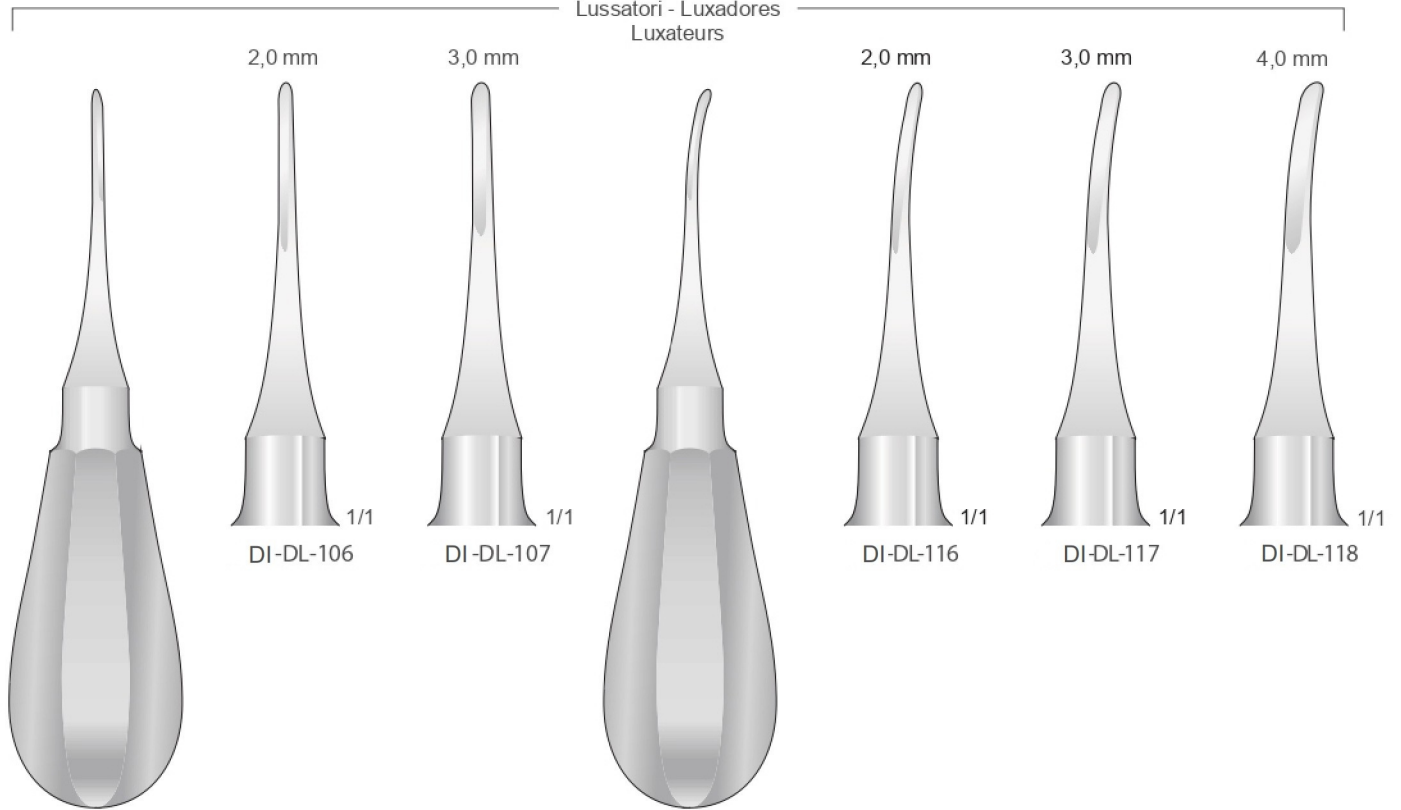

2,0 mm

3,0 mm

2,0 mm

3,0 mm

4,0 mm

DI-DL-106

DI-DL-107

DI-DL-116

DI-DL-117

DI-DL-118

DI-DL-106/ADM-DL-107  
120 mm

DI-DL-116/ DI-DL-118  
120 mm

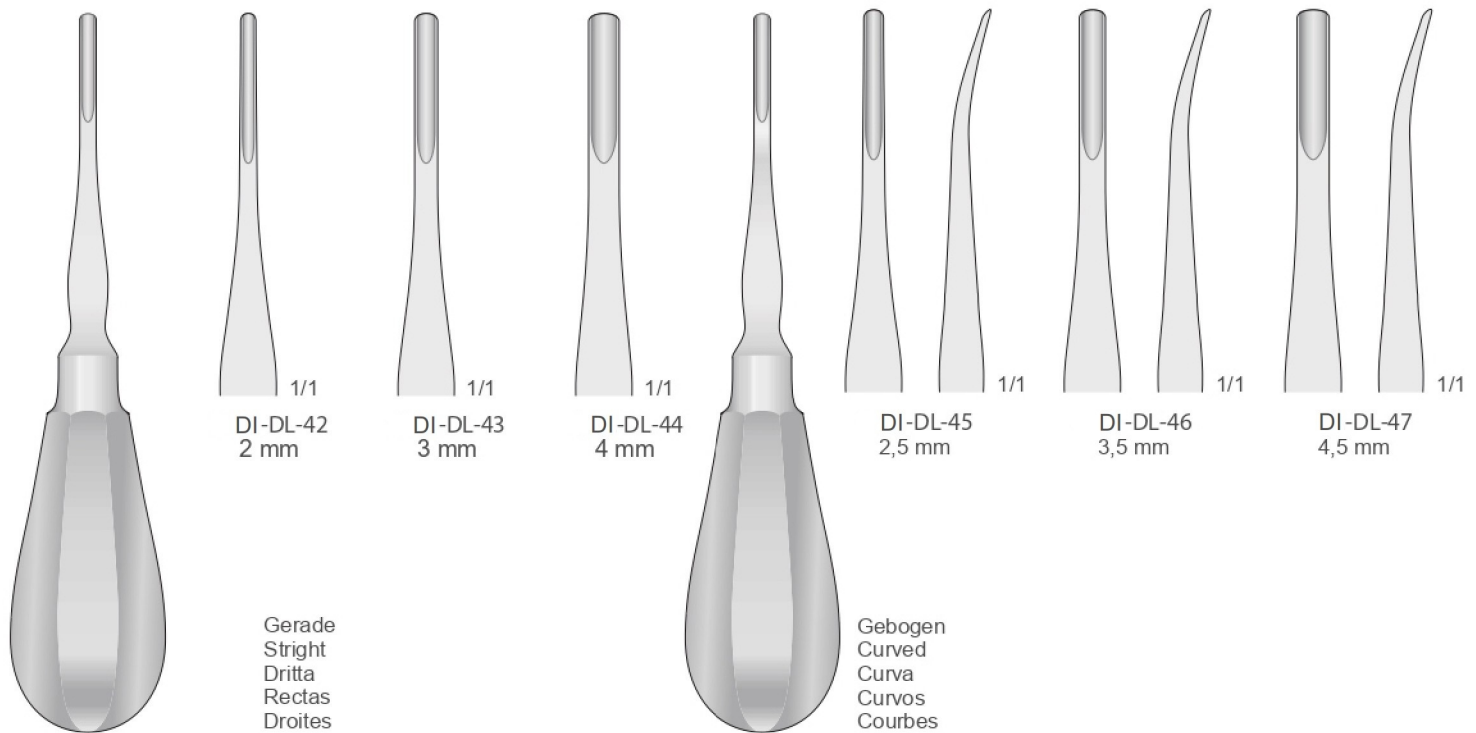

DI-DL-42  
2 mm

DI-DL-43  
3 mm

DI-DL-44  
4 mm

DI-DL-45  
2,5 mm

DI-DL-46  
3,5 mm

DI-DL-47  
4,5 mm

Gerade  
Stright  
Dritta  
Rectas  
Droites

Gebogen  
Curved  
Curva  
Curvos  
Courbes

BEIN  
DI-DL-42/ADM-DL-44

DI-DL-45 DI-DL-47



Wurzelheber  
Root Elevators  
Leve per radici  
Elevadores para raíces  
Elevateurs à racines

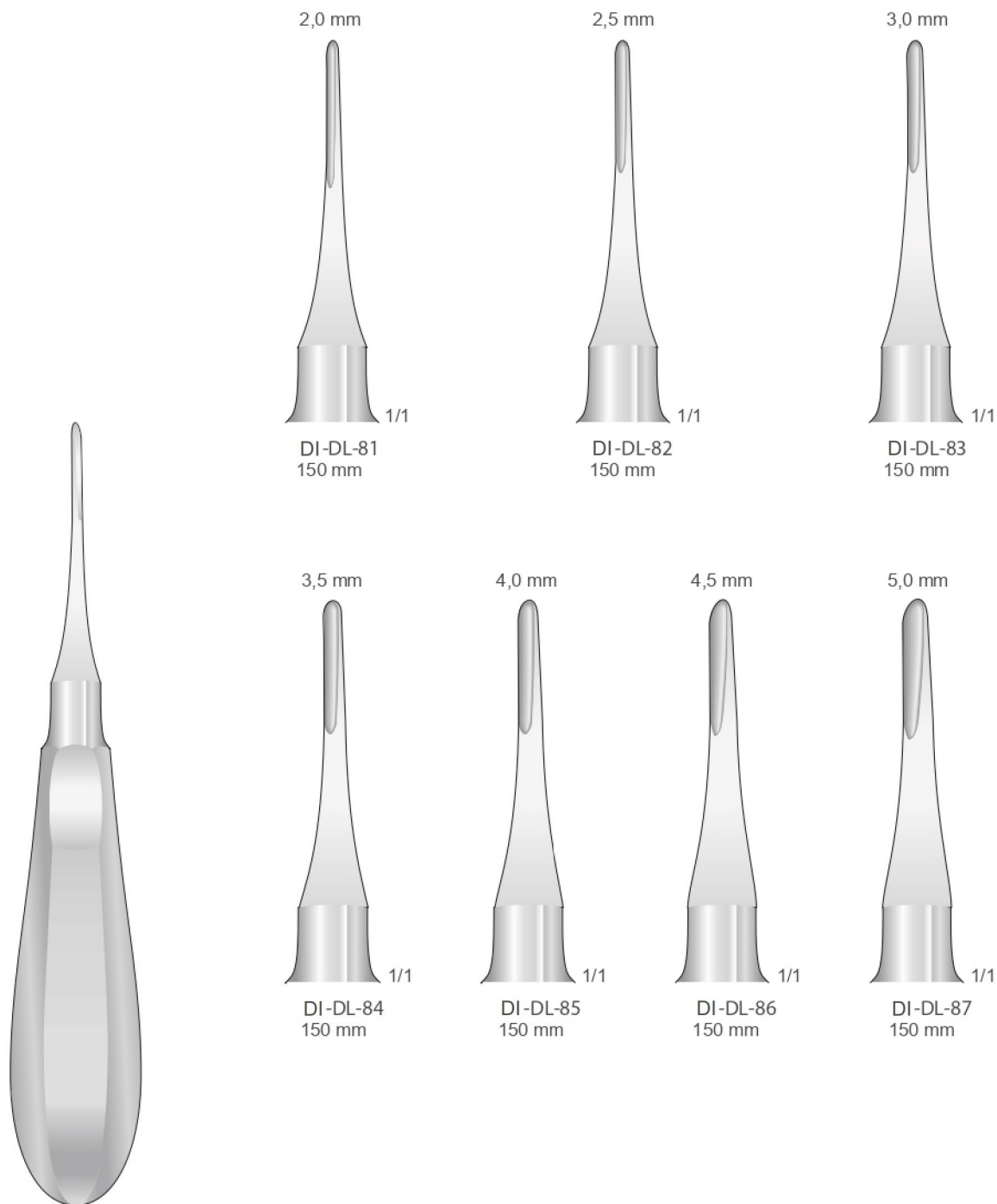

DI-DL-81/ DI-DL-87  
150 mm



Wurzelheber  
Root Elevators  
Leve per radici  
Elevadores para raíces  
Elevateurs à racines

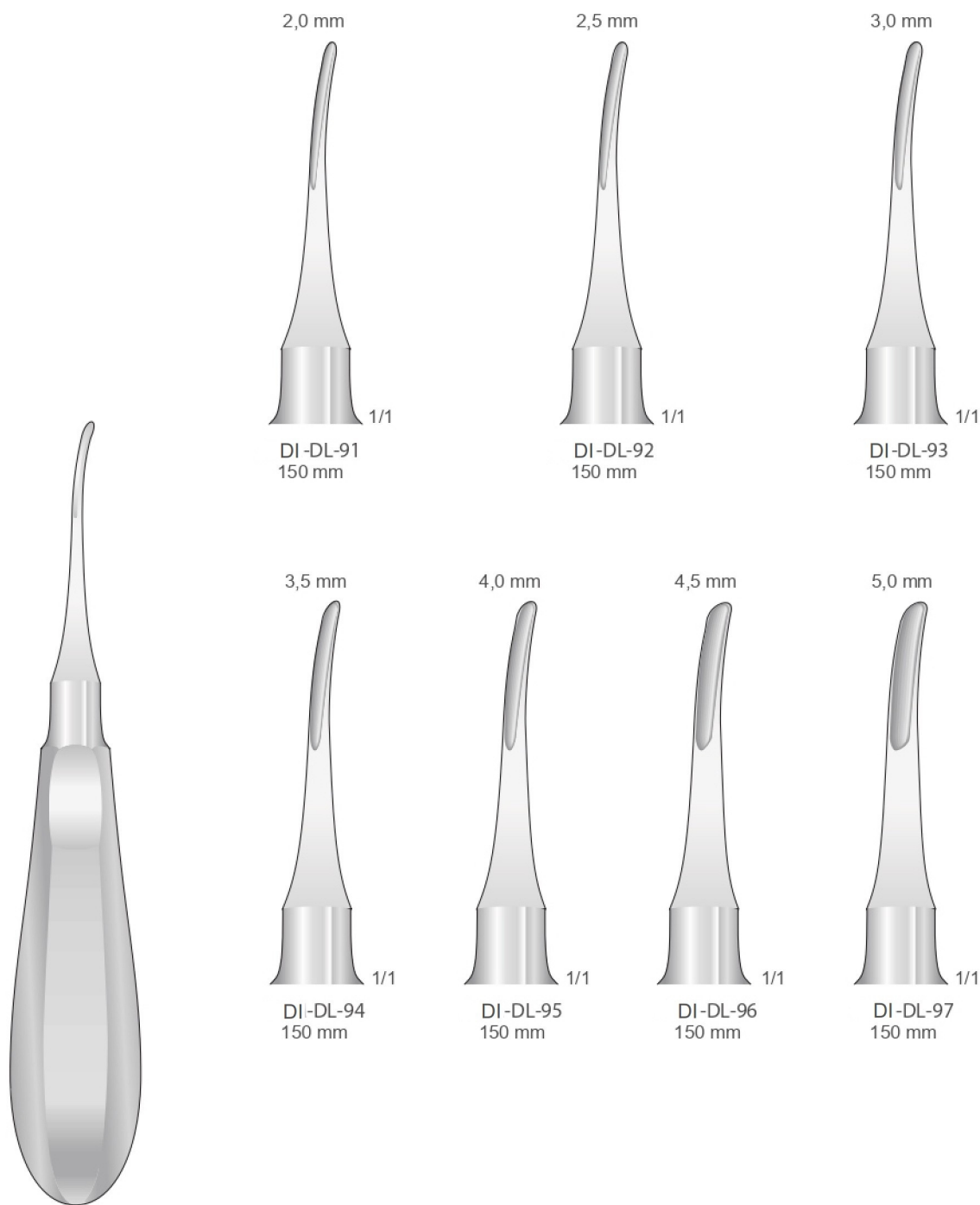

DI-DL-91/ DI-DL-97  
150 mm





Wurzelheber  
Root Elevators  
Leve per radici  
Elevadores para raíces  
Elevateurs à racines

Luxatoren  
Luxators  
Lussatori  
Luxadores  
Luxateurs

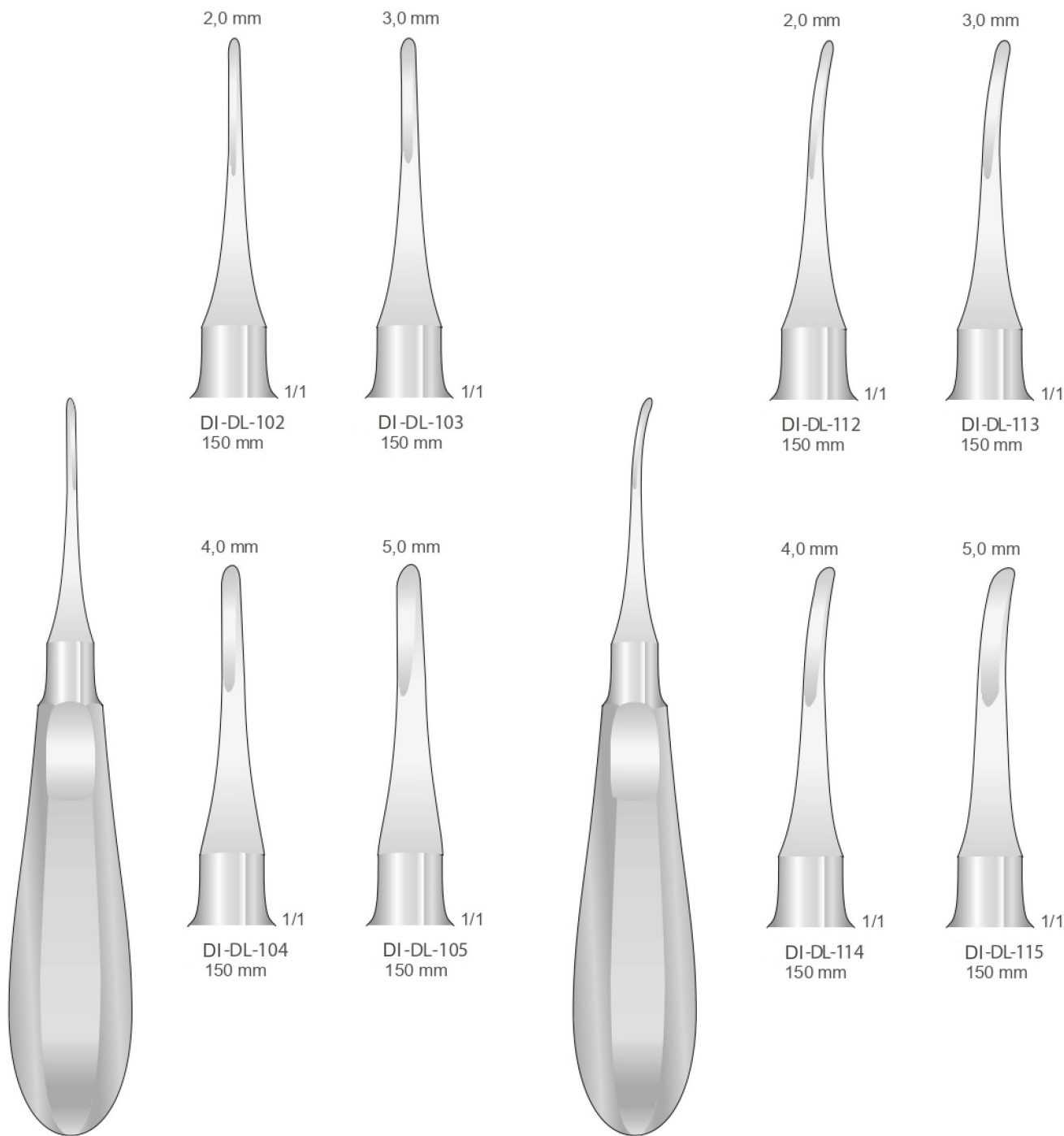

DI-DL-102/ DI-DL-105  
150 mm

DI-DL-112/ DI-DL-115  
150 mm



Wurzelheber  
Root Elevators  
Leve per radici  
Elevadores para raíces  
Elevateurs à racines

Wurzelspitzenheber  
Root fragment Elevators  
Leve per frammenti di radice  
Elevadores para fragmentos de raíces  
Elévateurs de fragments de racines

Gezant  
Serrated  
Dentellata  
Dentada  
Dentelé

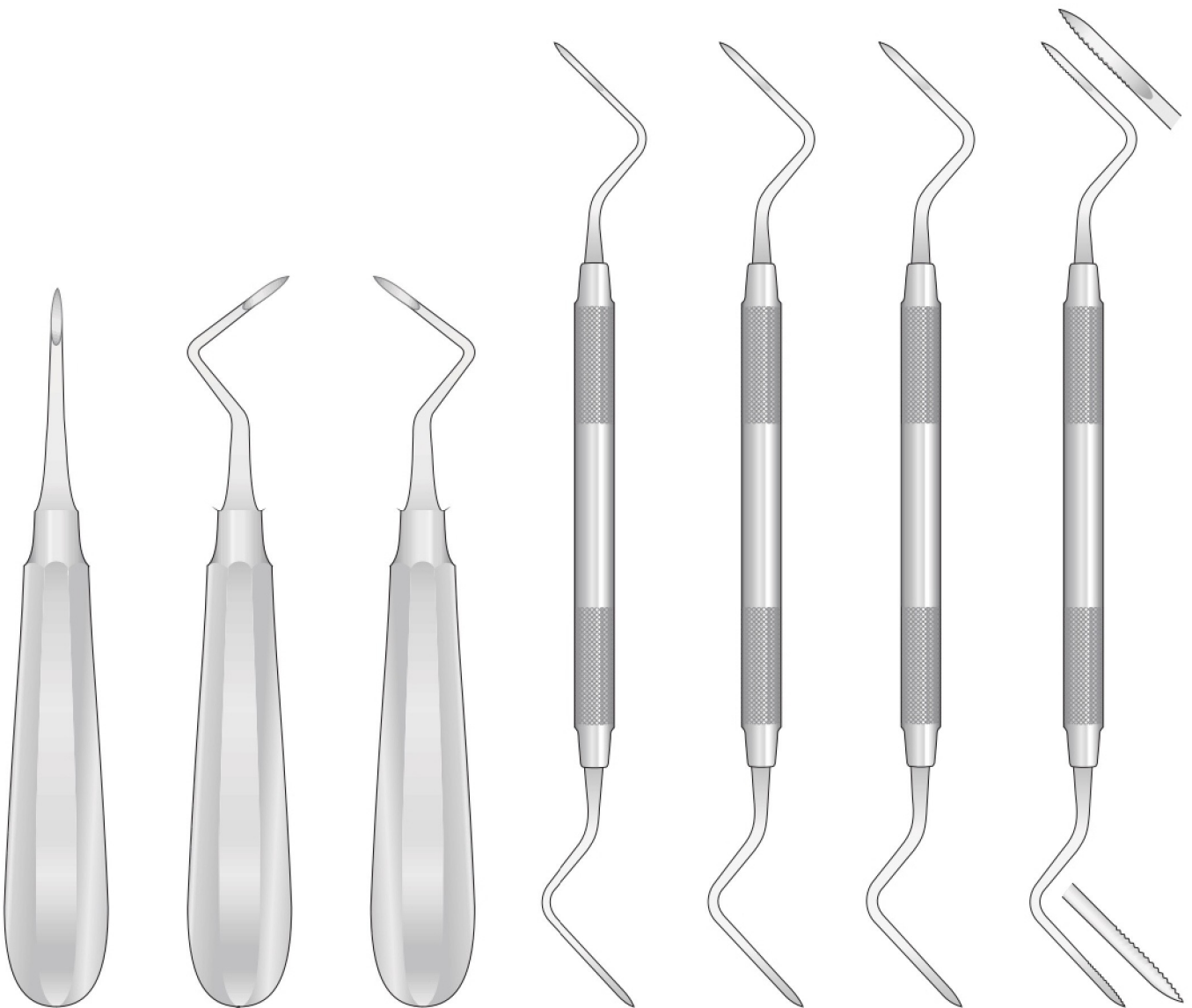

HEIDBRINK  
DI-HE-1  
140 mm

HEIDBRINK  
DI-HE-2  
140 mm

HEIDBRINK  
DI-HE-3  
140 mm

HEIDBRINK  
DI-725-1/2  
195 mm

HEIDBRINK  
DI-725-3/4  
195 mm

HEIDBRINK  
DI-725-5/6  
195 mm

HEIDBRINK  
DI-725-3/4S  
195 mm



Wurzelheber  
Root Elevators  
Leve per radici  
Elevadores para raíces  
Elevateurs à racines

Extraktionshebel für obere Weisheitszähne  
Luxator for upper wisdom teeth  
Leva per estrazione dente del giudizio superiore  
Elevador de extracción de muelas del juicio superiores  
Levier d'extraction pour dent de sagesse supérieures

Wurzelheber  
Root Elevators  
Leve per radici  
Elevadores para raíces  
Elevateurs de racines



ROSIN  
DI-DL-58  
160 mm



WARWICK-JAMES  
DI-DL-20  
160 mm



WARWICK-JAMES  
DI-DL-21  
155 mm



WARWICK-JAMES  
DI-DL-22  
155 mm

Obere  
Upper  
Superiori  
Superiores  
Supérieures

Untere  
Lower  
Inferiori  
Inferiores  
Inférieures

Untere  
Lower  
Inferiori  
Inferiores  
Inférieures



Wurzelheber  
Root Elevators  
Leve per radici  
Elevadores para raíces  
Elevateurs à racines

Eine seite gezahnt  
One side serrated  
Un lato dentellato  
Dentadura màs lado  
Dentelure sur un côté



DI-DL-76  
155 mm



DI-DL-77  
155 mm



DI-DL-78  
155 mm



DI-DL-79  
155 mm



Wurzelheber  
Root Elevators  
Leve per radici  
Elevadores para raíces  
Elevateurs à racines

Gezahnt  
Serrated  
Dentellate  
Dentadas  
Dentelé



Fig. 301

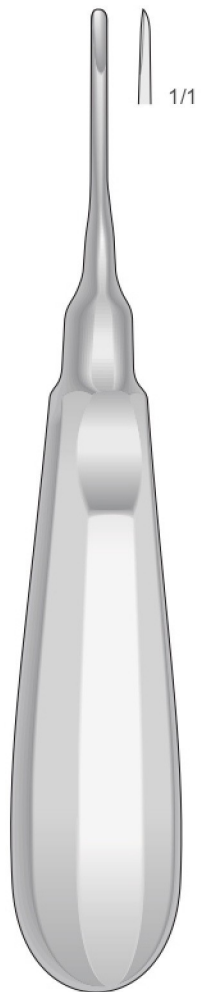

APEXO  
DI-DL-34  
160 mm

1/1

Fig. 302



DI-DL-35

Fig. 303

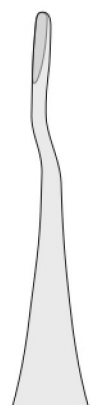

DI-DL-36

Fig. 77L

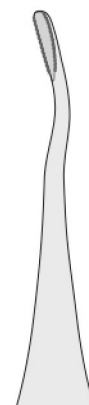

DI-DL-37

Fig. 77R

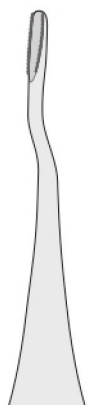

DI-DL-38

APEXO  
DI-DL-35/ADM-DL-36  
160 mm

APEXO  
DI-DL-37/ DI-DL-38  
160 mm



Wurzelheber  
Root Elevators  
Leve per radici  
Elevadores para raíces  
Elevateurs à racines

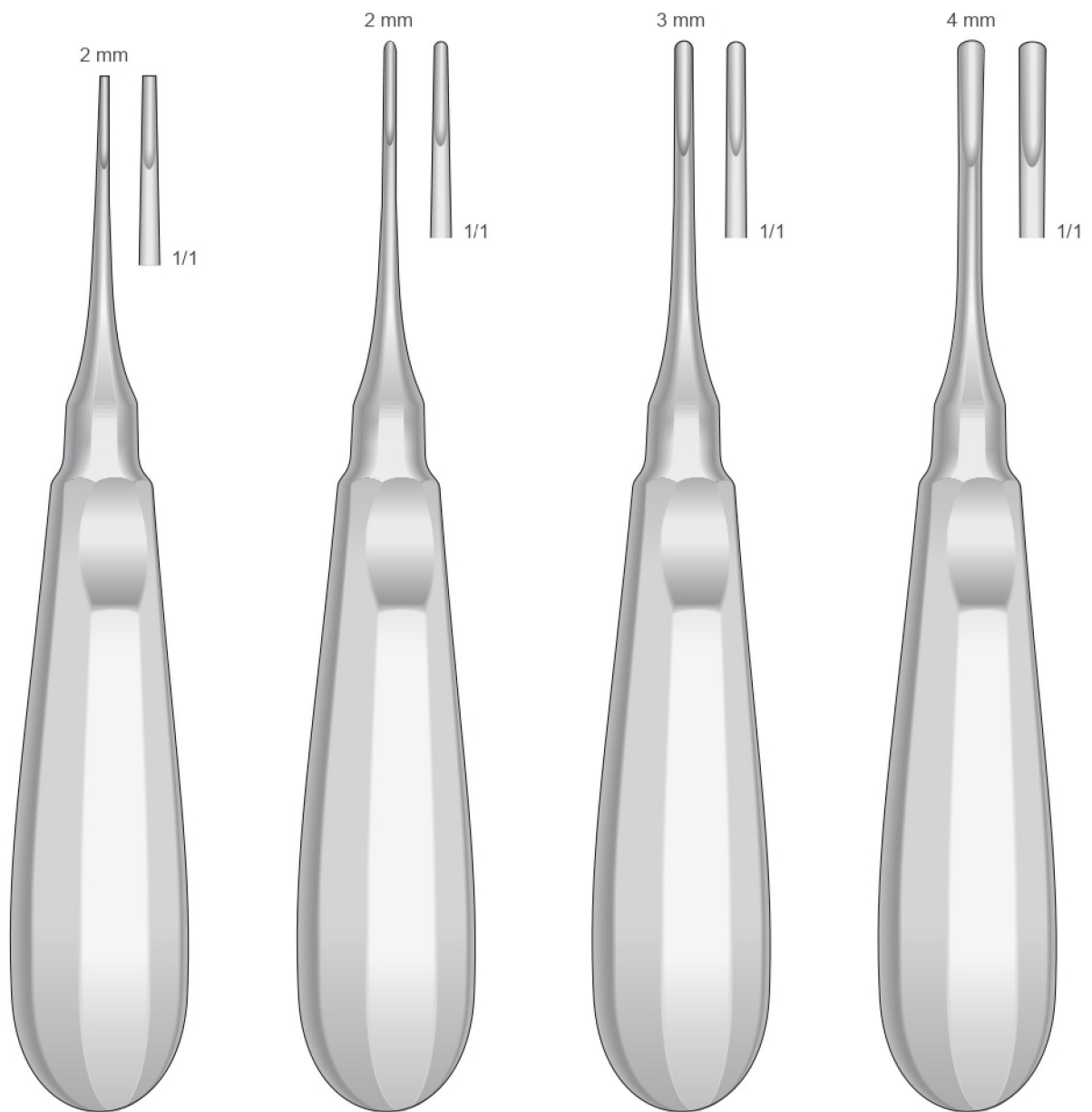

DI-BEIN-1T  
150 mm

DI-BEIN-2  
155 mm

DI-BEIN-3  
155 mm

DI-BEIN-4  
155 mm



Wurzelheber  
Root Elevators  
Leve per radici  
Elevadores para raíces  
Elevateurs à racines

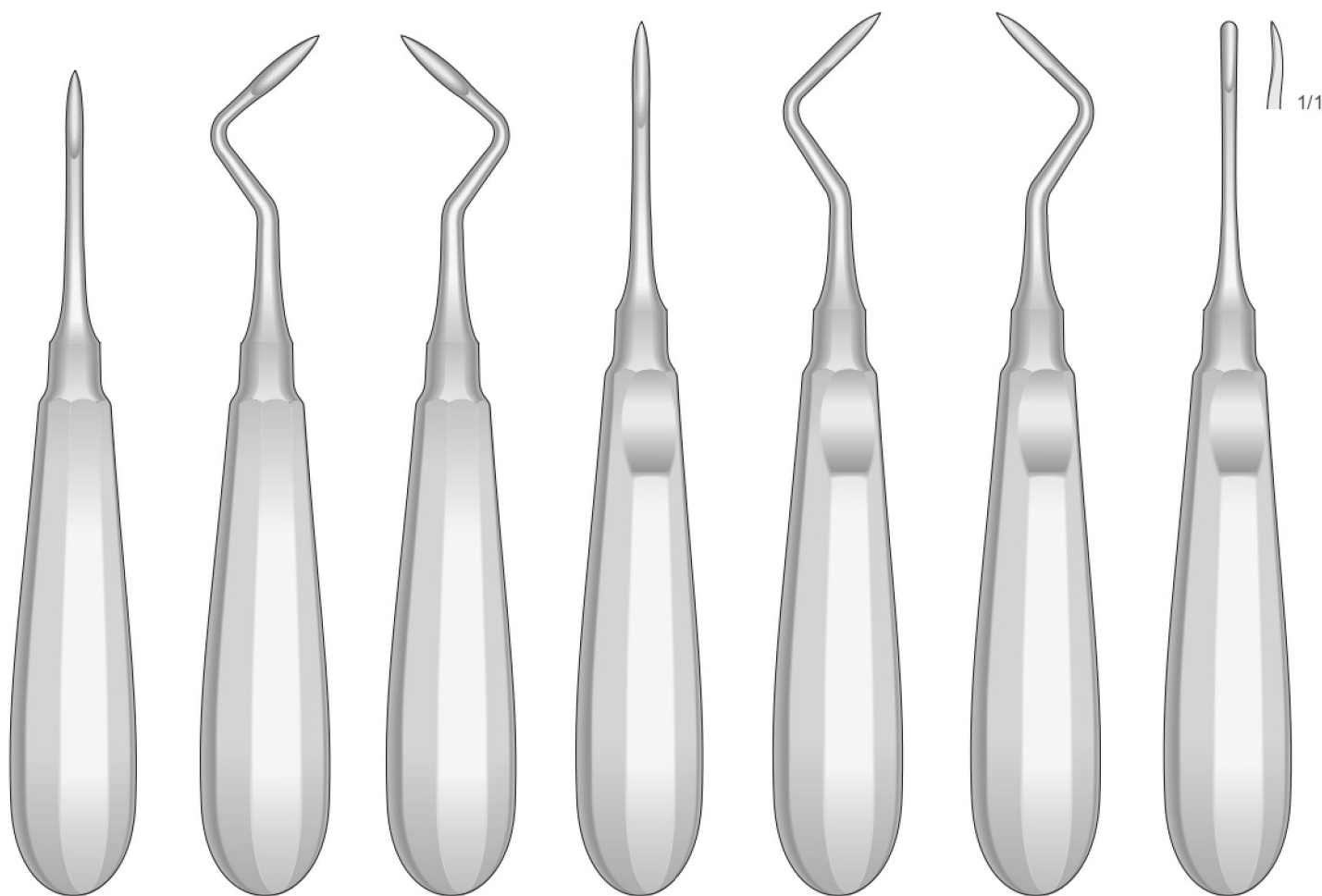

DI-FLOHR-1  
140 mm

DI-FLOHR-2  
150 mm

DI-FLOHR-3  
150 mm

DI-APICAL-1  
155 mm

DI-APICAL-2  
155 mm

DI-APICAL-3  
155 mm

DI-APICAL-4  
155 mm





Wurzelheber  
Root Elevators  
Leve per radici  
Elevadores para raíces  
Elevateurs à racines

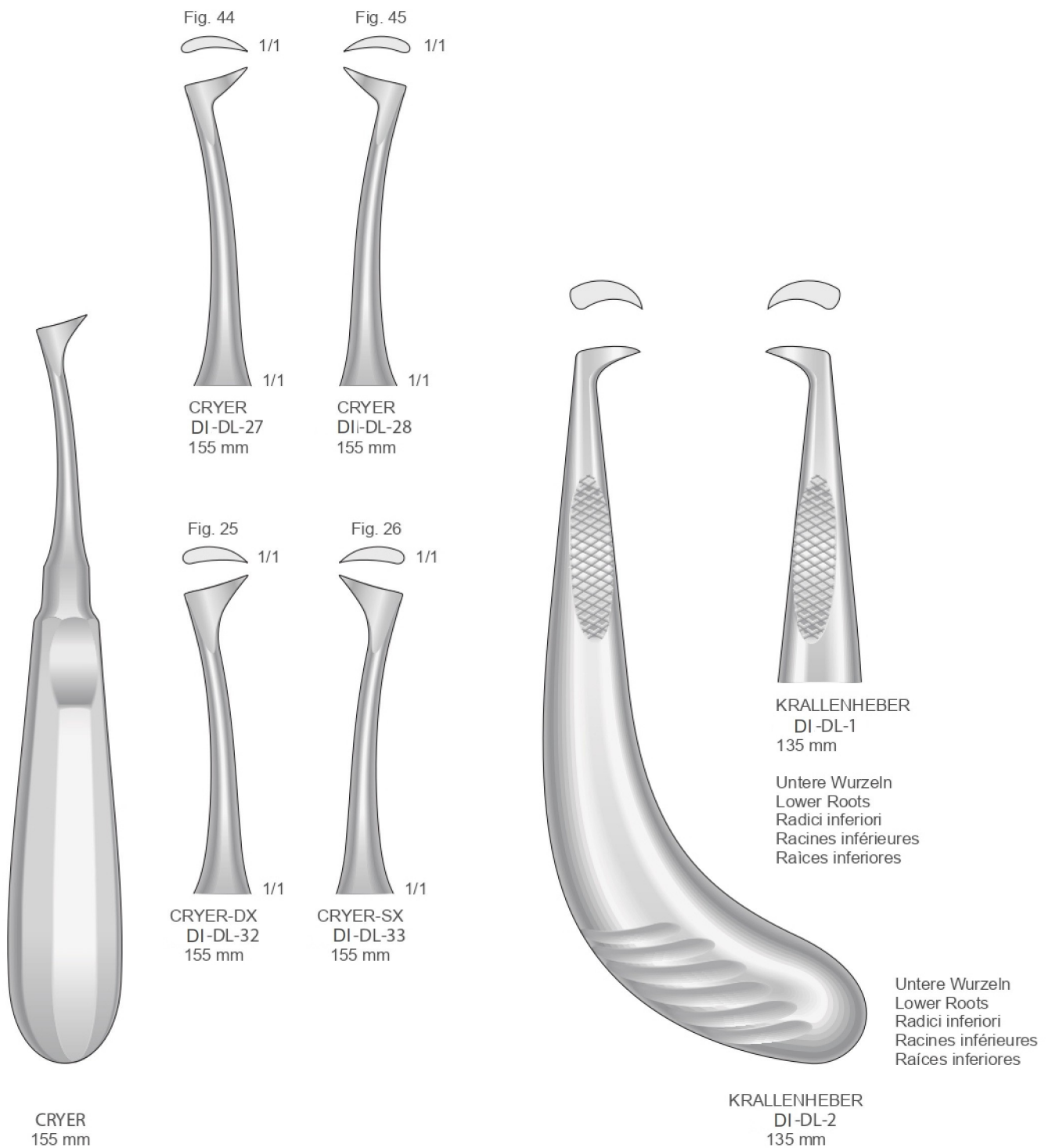



Wurzelheber  
Root Elevators  
Leve per radici  
Elevadores para raíces  
Elevateurs à racines

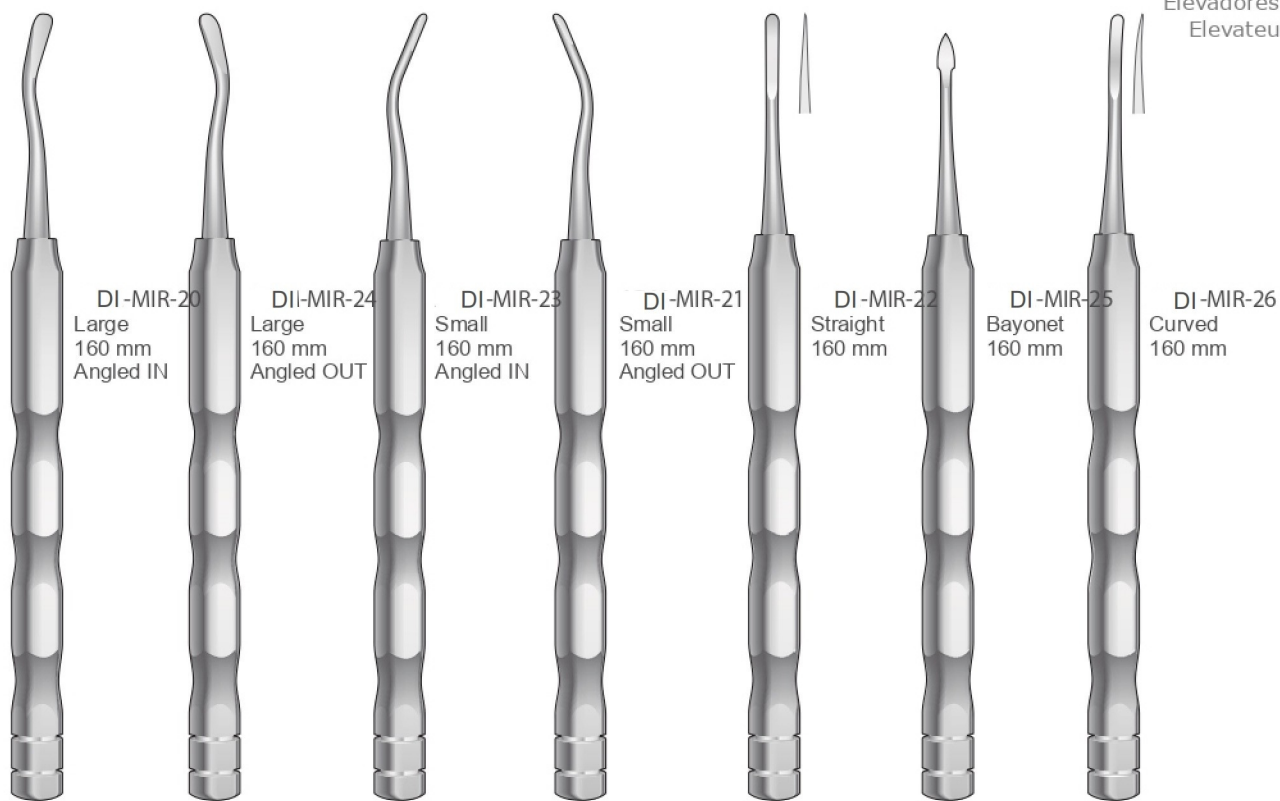
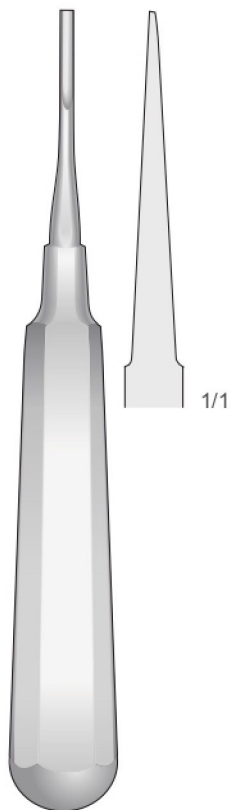
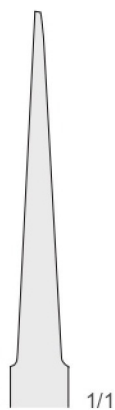

Fig. 1  
2,0 mm



COUPLAND  
DI-CO-1  
155 mm

Fig. 2  
3,6 mm



COUPLAND  
DI-CO-2  
155 mm

Fig. 3  
4,2 mm

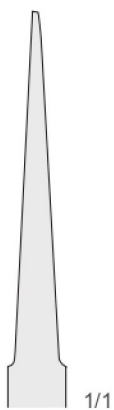

COUPLAND  
DI-CO-3  
155 mm

Fig. 1  
3,0 mm

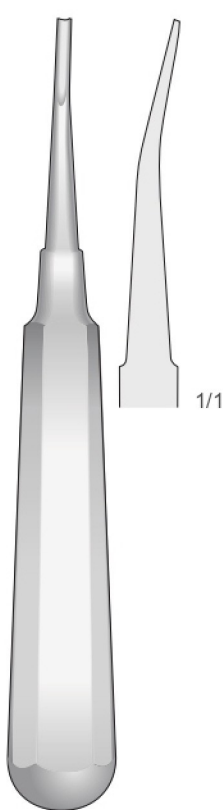

COUPLAND  
DI-CO-11  
155 mm

Fig. 2  
3,6 mm

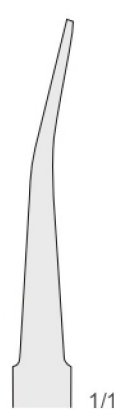

COUPLAND  
DI-CO-12  
155 mm

Fig. 3  
4,2 mm

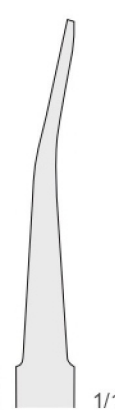

COUPLAND  
DI-CO-13  
155 mm



Wurzelheber  
Root Elevators  
Leve per radici  
Elevadores para raíces  
Elevateurs à racines

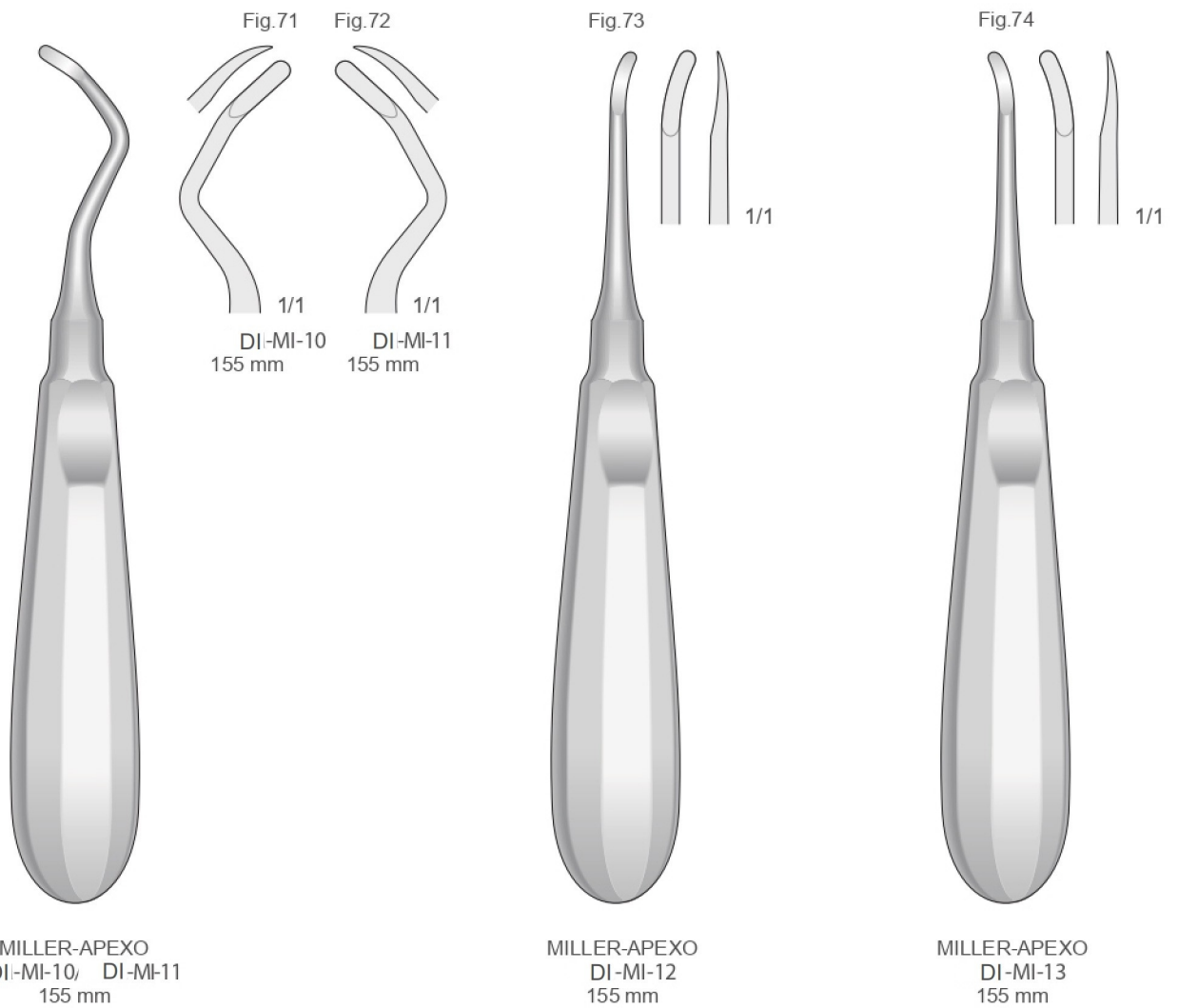



Wurzelheber  
Root Elevators  
Leve per radici  
Elevadores para raíces  
Elevateurs à racines

4 mm

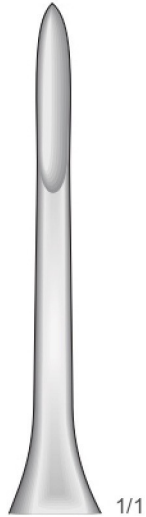

HYLIN  
DI-DL-11  
145 mm

2 mm



HYLIN-2C  
DI-DL-13  
145 mm

3 mm



HYLIN-3C  
DI-DL-14  
145 mm

3 mm



HYLIN-1  
DI-DL-17  
145 mm

3 mm

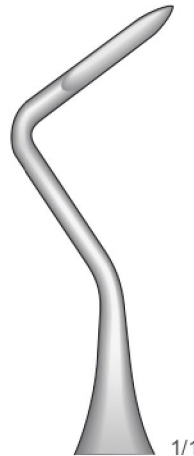

HYLIN-2  
DI-DL-18  
145 mm

3 mm

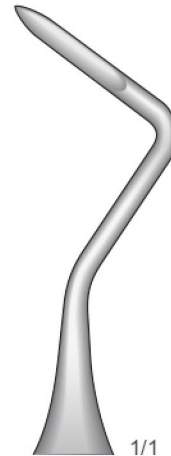

HYLIN-3  
DI-DL-19  
145 mm

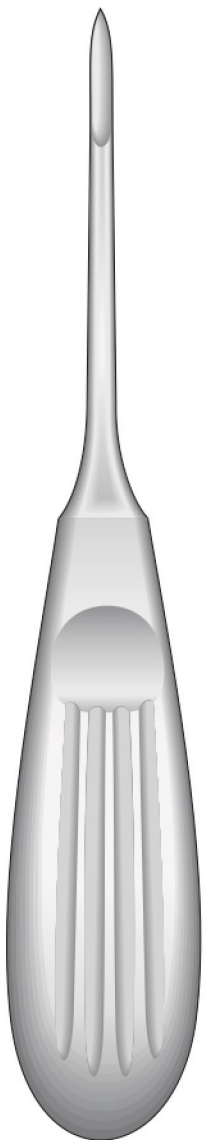

HYLIN  
DI-DL-11/ DI-DL-19  
145 mm



Wurzelheber  
Root Elevators  
Leve per radici  
Elevadores para raíces  
Elevateurs à racines

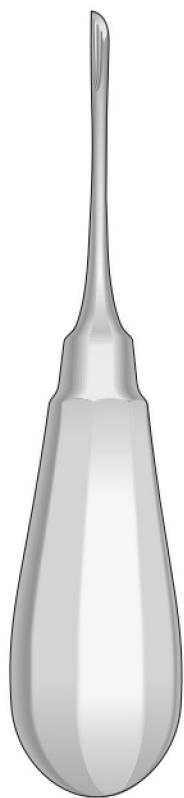

KOPP  
DI-DL-30  
130 mm

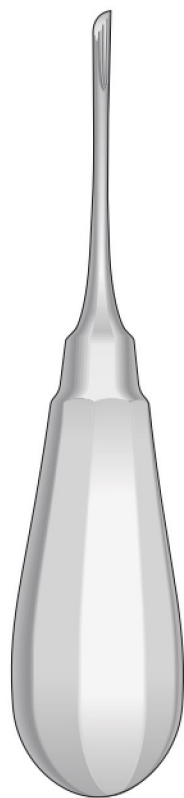

KOPP  
DI-DL-31  
130 mm

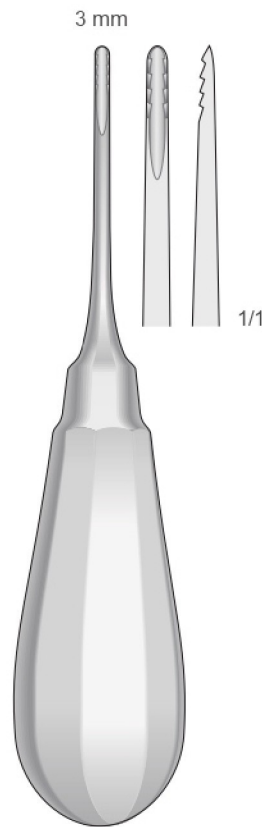

DI-BEIN-1Z  
130 mm

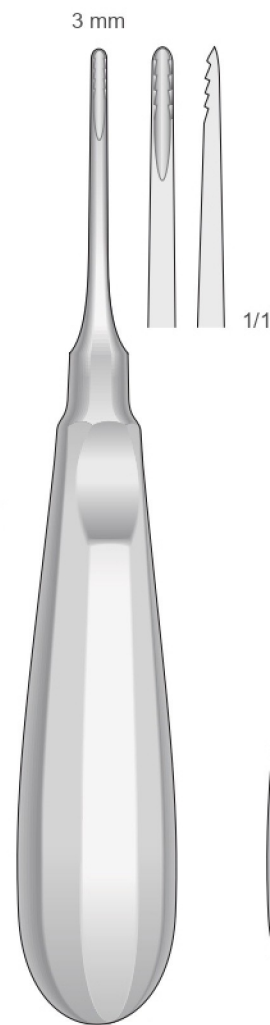

DI-BEIN-2Z  
155 mm

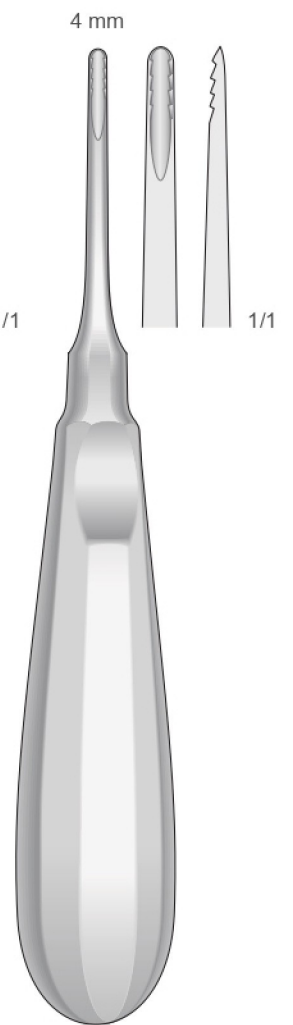

LINDO-LEVIEN  
DI-BEIN-4Z  
155 mm

Wurzelheber  
Root Elevators  
Leve per radici  
Elevadores para raíces  
Elevateurs à racines

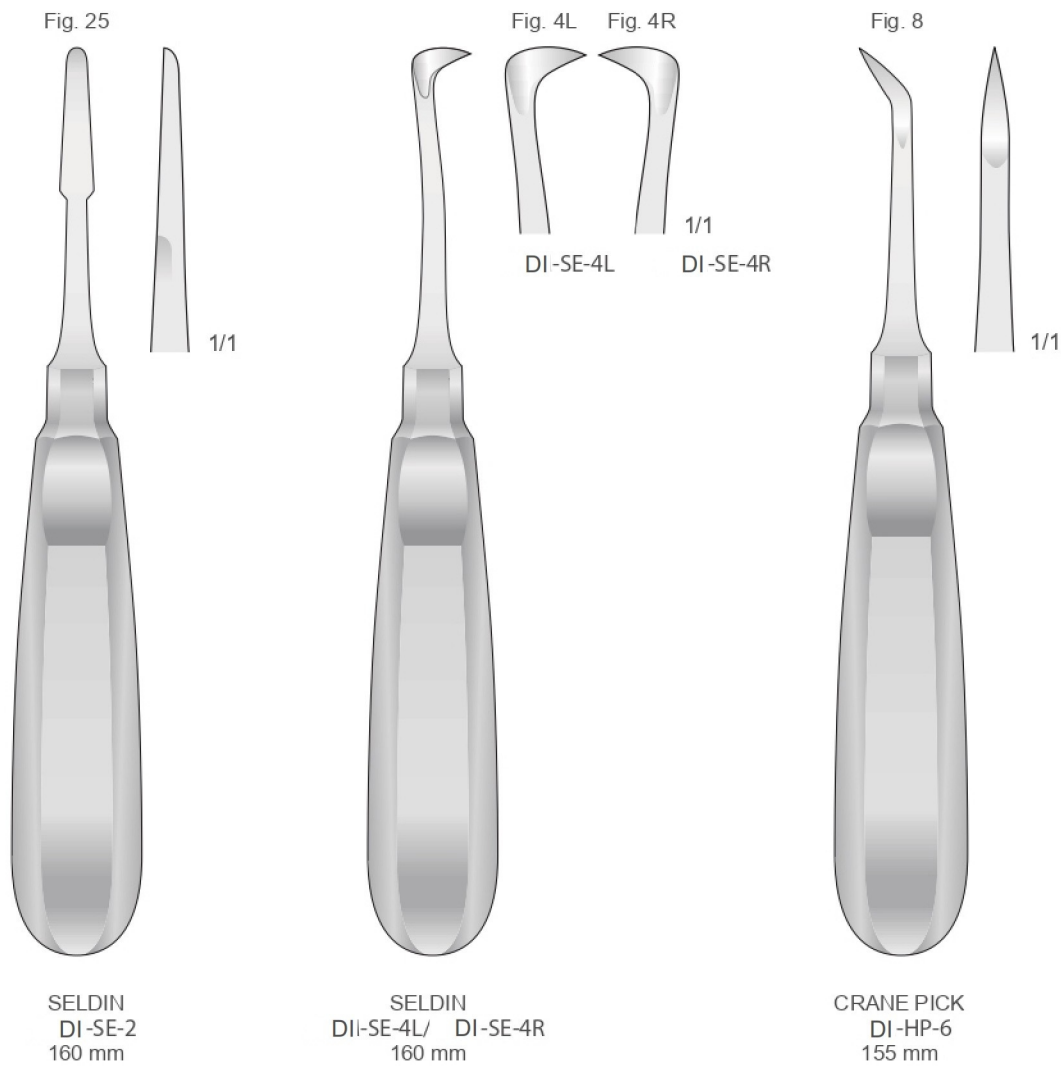



Wurzelheber  
Root Elevators  
Leve per radici  
Elevadores para raíces  
Elevateurs à racines

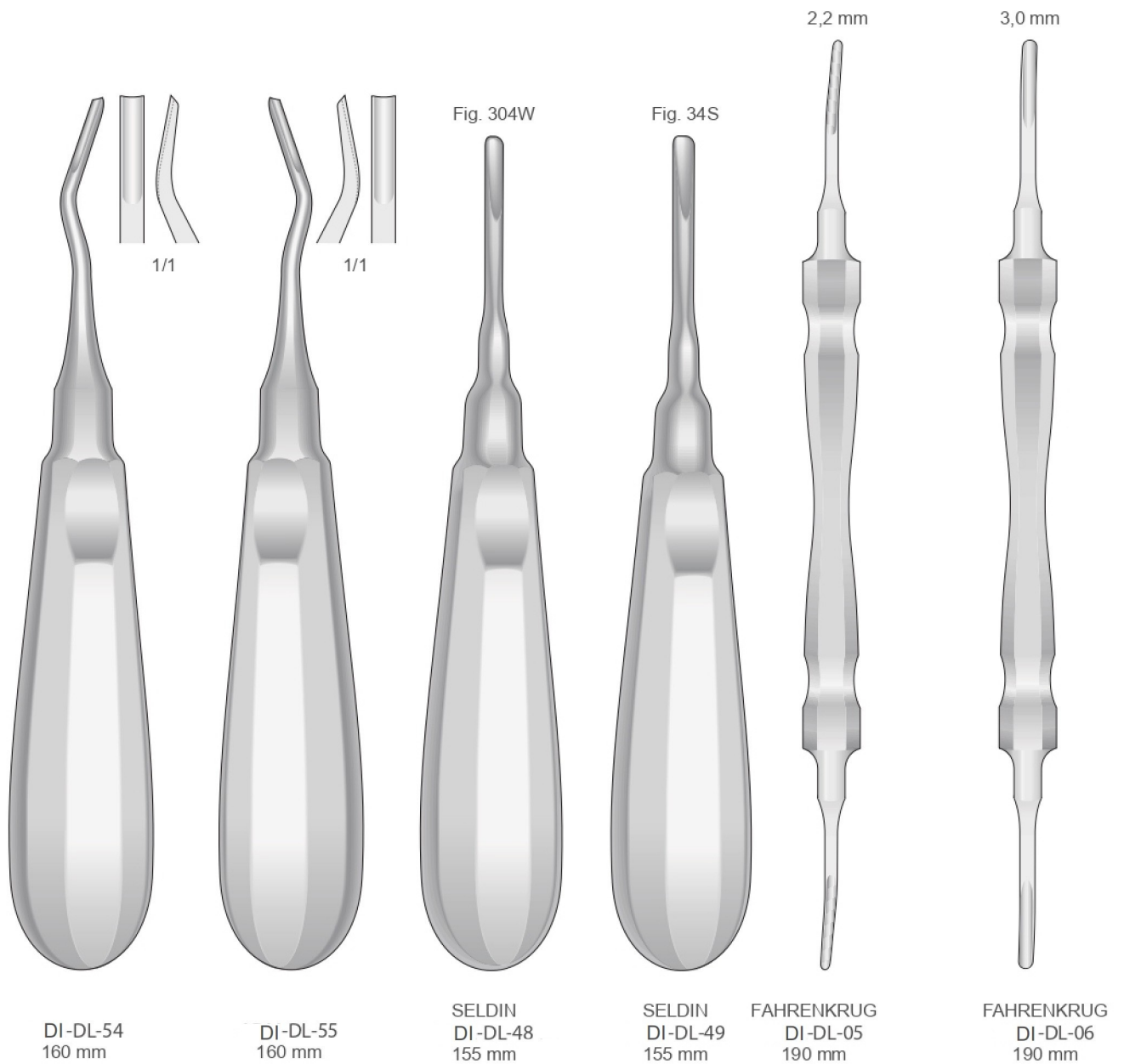



Wurzelheber  
Root Elevators  
Leve per radici  
Elevadores para raíces  
Elevateurs à racines

Fig. 6

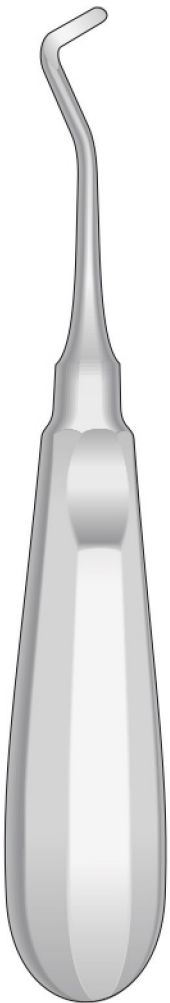

POTT  
DI-DL-98  
160 mm

Fig. 7



POTT  
DI-DL-99  
160 mm

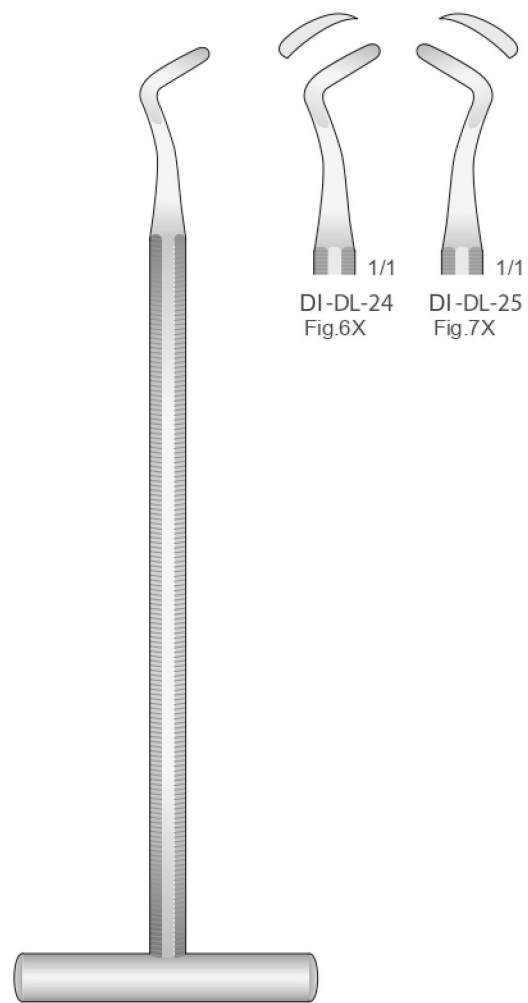

POTT  
DI-DL-24/ADM-DL-25  
155 mm



Wurzelheber  
Root Elevators  
Leve per radici  
Elevadores para raíces  
Elevateurs à racines

Syndesmotome  
Syndesmotomes  
Sindesmotomi  
Syndesmôtomos  
Syndesmotomos

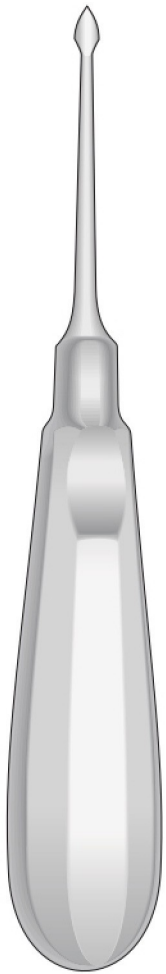

BERNARD  
DI-DL-73/ DI-DL-124

Gerade  
Straight  
Diritto  
Rectas  
Droites



BERNARD  
DI-DL-73  
150 mm

Links  
Left  
Sinistra  
A la izquierda  
À gauche



BERNARD  
DI-DL-74  
140 mm

Rechts  
Right  
Destro  
A la derecha  
À droite

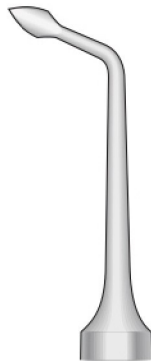

BERNARD  
DI-DL-75  
140 mm

Bajonett - Bayonet  
Baionetta - Bayoneta  
Baionette

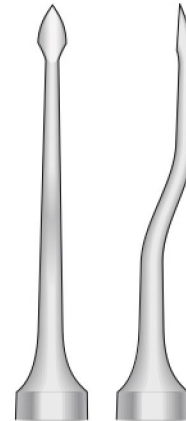

BERNARD  
DI-DL-123  
150 mm

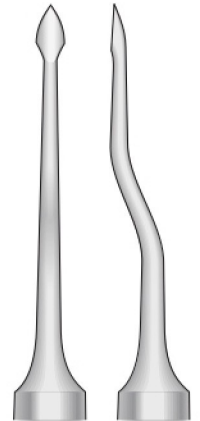

BERNARD  
DI-DL-124  
150 mm



Wurzelheber  
Root Elevators  
Leve per radici  
Elevadores para raíces  
Elevateurs à racines

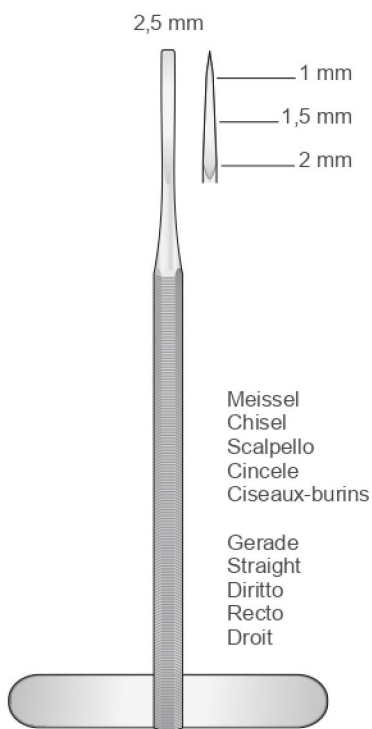

DI-DL-88  
130 mm

Meissel  
Chisel  
Scalpello  
Cincele  
Ciseaux-burins  
  
Gerade  
Straight  
Diritto  
Recto  
Droit

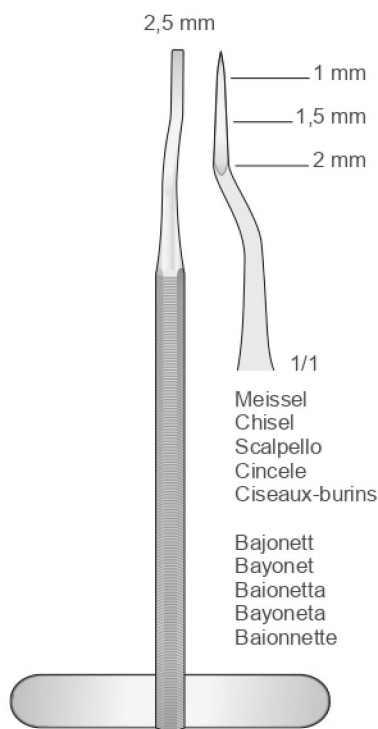

DI-DL-89  
130 mm

Meissel  
Chisel  
Scalpello  
Cincele  
Ciseaux-burins  
  
Bajonett  
Bayonet  
Baionetta  
Bayoneta  
Baionnette

Syndesmotome  
Syndesmotomes  
Sindesmotomo  
Syndesmõtomos  
Syndesmotomes



DI-DL-63  
158 mm

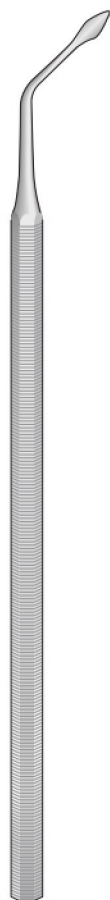

DI-DL-62  
152 mm



DI-DL-61  
152 mm

Raspatorien  
Raspatories  
Scollaperiosteo  
Legras  
Rugines



DI-DL-59  
150 mm

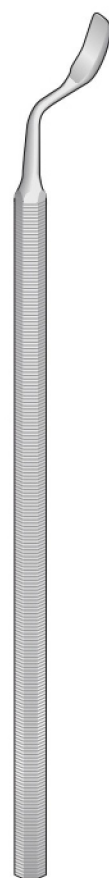

DI-DL-68  
150 mm



DI-DL-69  
150 mm



Wurzelheber  
Root Elevators  
Leve per radici  
Elevadores para raíces  
Elevateurs à racines

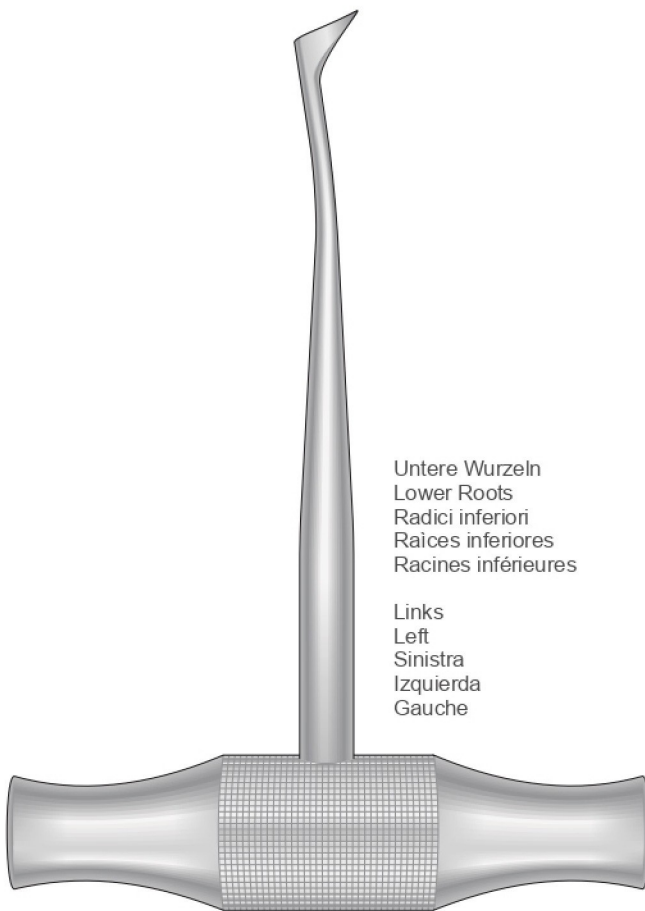

Untere Wurzeln  
Lower Roots  
Radici inferiori  
Raíces inferiores  
Racines inférieures

Links  
Left  
Sinistra  
Izquierda  
Gauche

WINTER  
DI-DL-100  
Fig.1

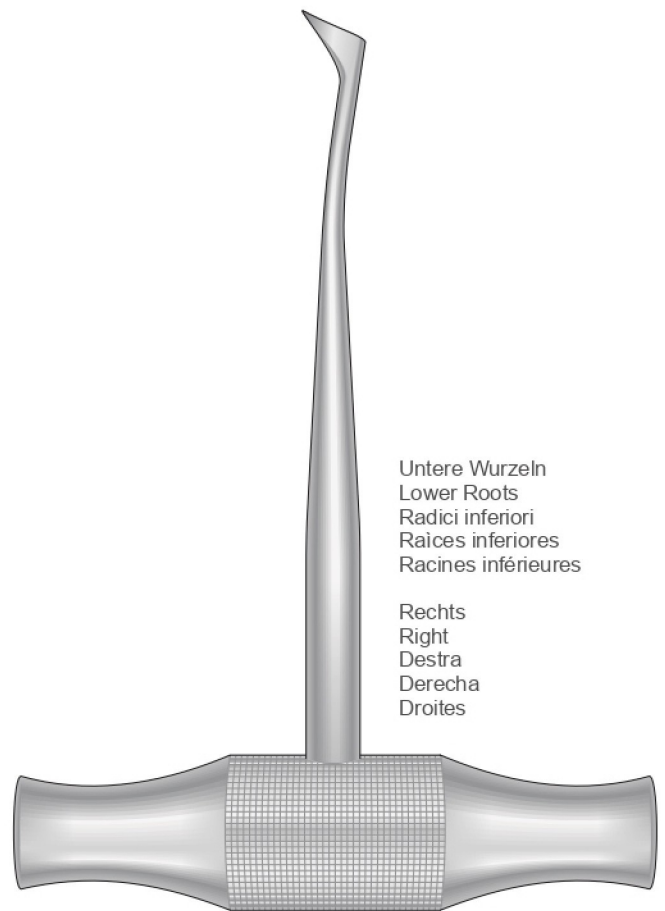

Untere Wurzeln  
Lower Roots  
Radici inferiori  
Raíces inferiores  
Racines inférieures

Rechts  
Right  
Destra  
Derecha  
Droites

WINTER  
DI-DL-101  
Fig.2



Wurzelheber  
Root Elevators  
Leve per radici  
Elevadores para raíces  
Elevateurs à racines

Fig. 1L



WINTER  
DI-DL-64  
120 mm

Fig. 1R



WINTER  
DI-DL-65  
120 mm

Fig. 14L



WINTER  
DI-DL-66  
125 mm

Fig. 14R

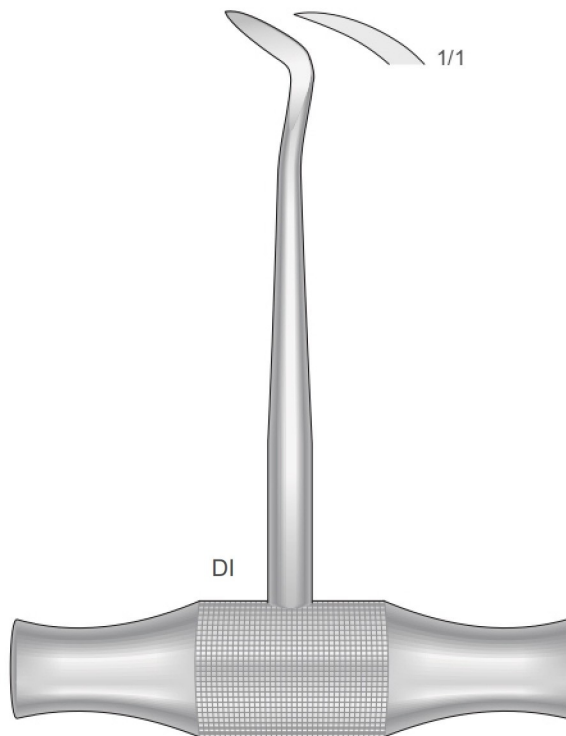

WINTER  
DI-DL-67  
125 mm



Wurzelheber  
Root Elevators  
Leve per radici  
Elevadores para raíces  
Elevateurs à racines

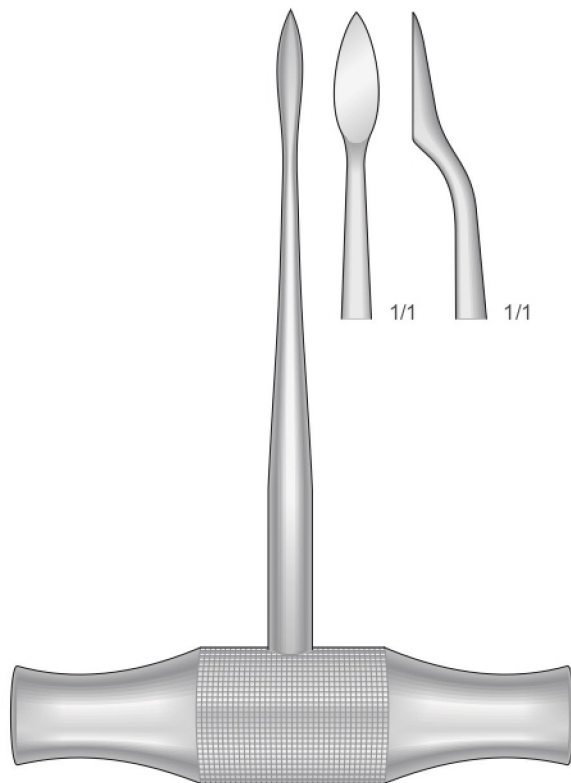

LECLUSE  
DI-DL-90  
130 mm



BARRY  
DI-DL-110  
Fig. 322

Links  
Left  
Sinistra  
Izquierda  
Gauche



BARRY  
DI-DL-111  
Fig. 323

Rechts  
Right  
Dextra  
Derecha  
Droites

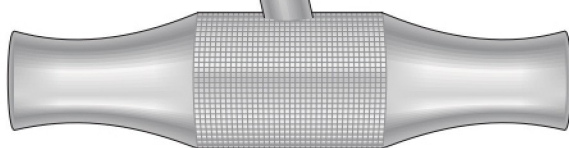

BARRY  
DI-DL-108 Fig. 320  
115 mm

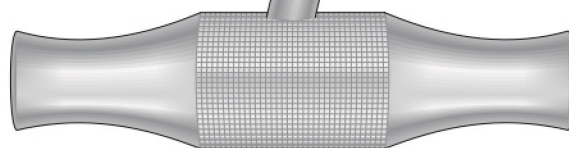

BARRY  
DI-DL-109 Fig. 321  
115 mm





Wurzelheber  
Root Elevators  
Leve per radici  
Elevadores para raíces  
Elevateurs à racines

3 mm



DI-LA-1  
160 mm

3 mm



DI-LA-2  
160 mm

4 mm



DI-LA-3  
160 mm

4 mm



DI-LA-4  
160 mm

4,5 mm



DI-LA-5  
160 mm

4,5 mm



DI-LA-6  
160 mm





Wurzelheber  
Root Elevators  
Leve per radici  
Elevadores para raíces  
Elevateurs à racines



DI-LA-7  
160 mm



DI-LA-8  
160 mm



DI-LA-9  
160 mm



DI-LA-10  
160 mm



Wurzelheber  
Root Elevators  
Leve per radici  
Elevadores para raíces  
Elevateurs à racines

2 mm



DI-LA-11  
155 mm

3 mm



DI-LA-12  
155 mm

4 mm



DI-LA-13  
155 mm



DI-LA-16  
160 mm



DI-LA-17  
160 mm



Wurzelheber  
Root Elevators  
Leve per radici  
Elevadores para raíces  
Elevateurs à racines



DI-LA-20  
160 mm



DI  
DI-LA-21  
160 mm



DI-LA-22  
160 mm



DI-LA-23  
160 mm



Syndesmotome  
Syndesmotomes  
Sindesmotomo  
Syndesmòtomos  
Syndesmotomes



Massiv  
Solid  
Manico  
Pieno  
Massif

CHOMPRET  
DI-CH-11  
150 mm



Massiv  
Solid  
Manico  
Pieno  
Massif

CHOMPRET  
DI-CH-12  
150 mm



Massiv  
Solid  
Manico  
Pieno  
Massif

CHOMPRET  
DI-CH-13  
150 mm



Massiv  
Solid  
Manico  
Pieno  
Massif

CHOMPRET  
DI-CH-14  
145 mm



CHOMPRET  
DI-CH-1  
165 mm



CHOMPRET  
DI-CH-2  
165 mm



CHOMPRET  
DI-CH-3  
165 mm



CHOMPRET  
DI-CH-4  
160 mm



Scalers - Periotomes  
Ablatori di tartaro - Periotomi  
Limpiadores de sarro - Periotomos  
Detartreurs - Périotomes

MORSE - SCALERS

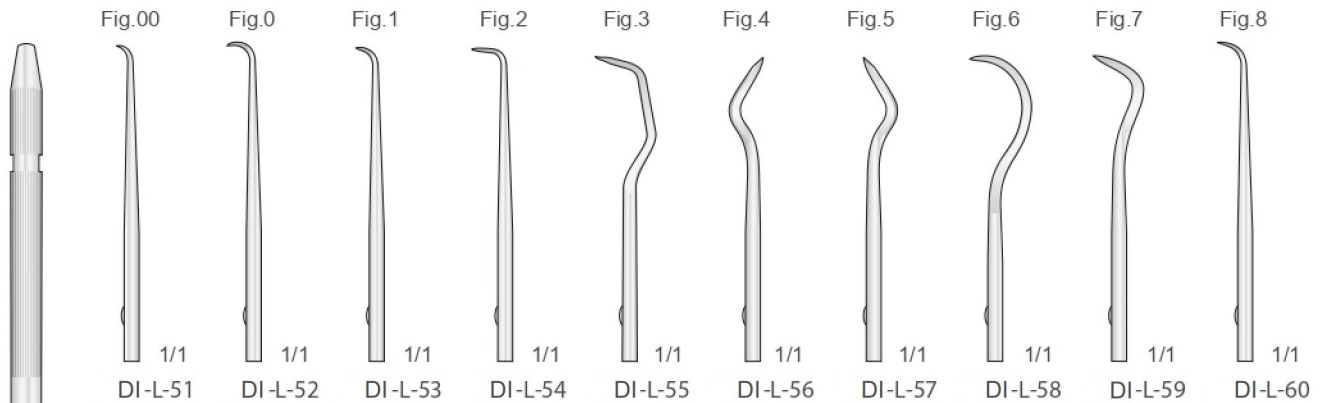

DI-MA-8  
125 mm  
NicheADM-L-Crom

Ersatz  
Insert for replacement  
Inserto di ricambio  
Puntas de recambio  
Pointes de rechange

Periotome - Periotomes  
Periotomi - Periotomos  
Périotomes

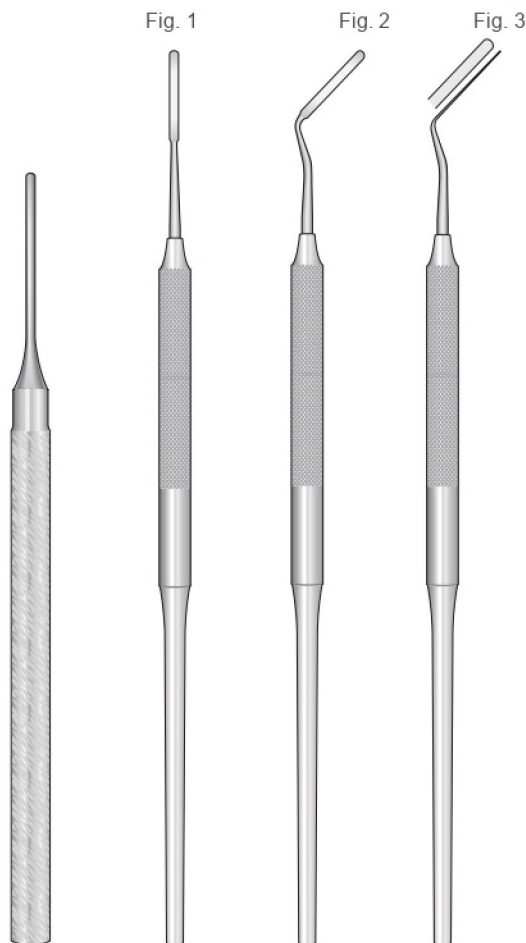

DI-MIR-09 140 mm  
DI-MC-11 160 mm  
DI-MC-12 160 mm  
DI-MC-13 160 mm

Fig. 1 Fig. 2 Fig. 3

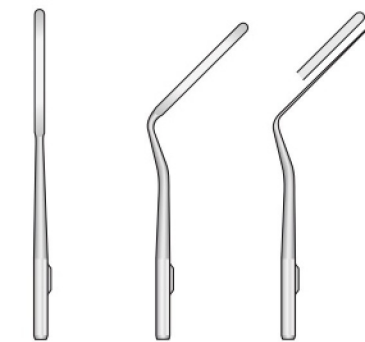

DI-L-71 DI-L-72 DI-L-73

Für / For  
Per / Para / Pour  
DI-MA-9



DI-MA-9R  
48 mm

DI-MA-9  
Handle  
140 mm  
Rostfrei  
Stainless Steel  
Inox

DI-MC-70  
( DI-MA-9 + DI-L-71,  
DI-L-72, DI-L-73)  
Komplett mit 1 Griff + 3 Spatel  
Complete with 1 Handle + 3 Spatulas  
Completo di 1 Manico + 3 Spatole  
Completo con 1 mango + 3 Espátulas  
Complete avec 1 Manche + 3 Spatules

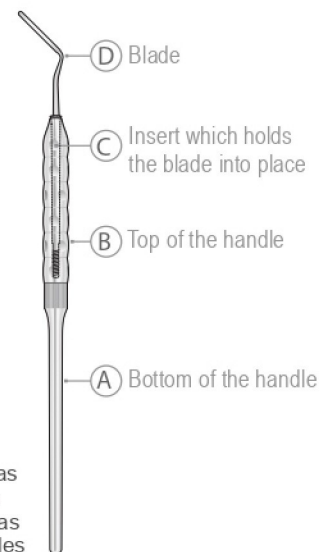



Syndesmotome  
Syndesmotomes  
Sindesmotomi  
Syndesmótomos  
Syndesmotomes

**ADM-SDM-C**  
Komplett mit 2 Griffe + 20 Klängen  
Complete with 2 Handles + 20 Blades  
Completo di 2 Manici + 20 lame  
Completo con 2 mangos + 20 hojas  
Complete avec 2 Manches + 20 lames

**ADM-SD-M**  
Griff  
Handle  
Manico  
Mango  
Manche

**ADM-SDM-9**  
Komplett mit 2 Griffe + 9 Klängen APICALI  
Complete with 2 Handles + 9 Blades APICALI  
Completo di 2 Manici + 9 lame APICALI  
Completo con 2 mangos + 9 hojas APICALI  
Complete avec 2 Manches + 9 lames APICALI

**ADM-SDM-11**  
Komplett mit 2 Griffe + 11 Klängen CERVICALI  
Complete with 2 Handles + 11 Blades CERVICALI  
Completo di 2 Manici + 11 lame CERVICALI  
Completo con 2 mangos + 11 hojas CERVICALI  
Complete avec 2 Manches + 11 lames CERVICALI



Lame CERVICALI

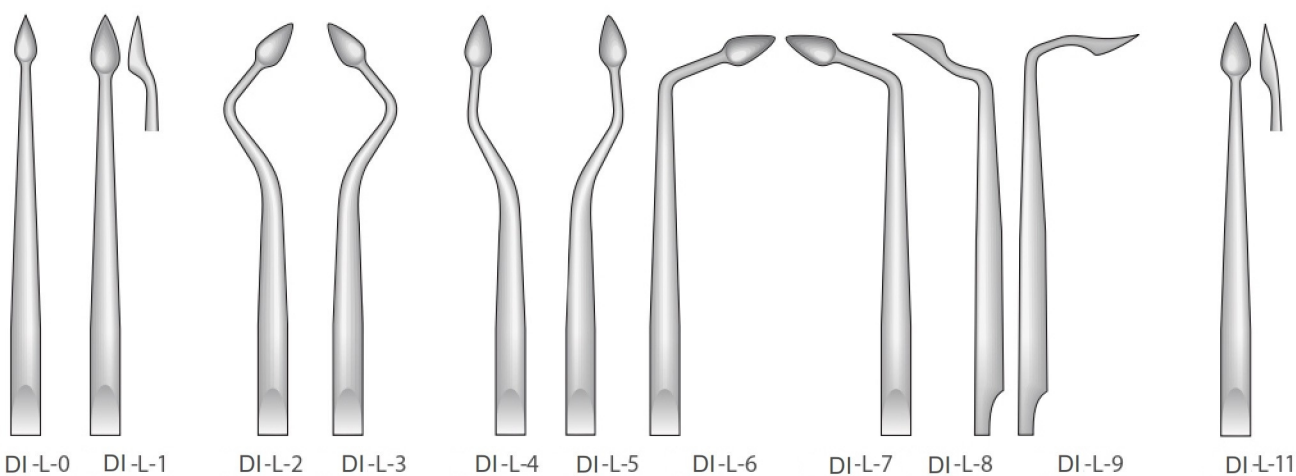

Lame APICALI

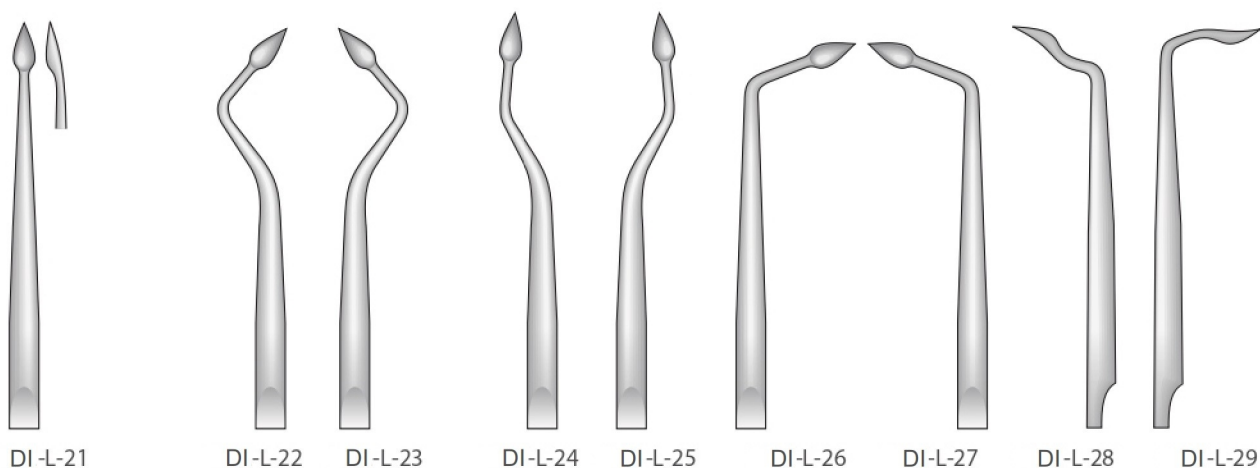

DI-SD-M