

Periosteal Curettes Rongeurs



Health Fast Surgical

Surgical Manufacturer Company

www.healthfastsurgical.com

**DENTAL
INSTRUMENTS CATALOGUE**



Raspatorien
Periosteals (Raspatories)
Scollaperiosteai (Periostotomi)
Periostótomos (Legras)
Rugines périostiques

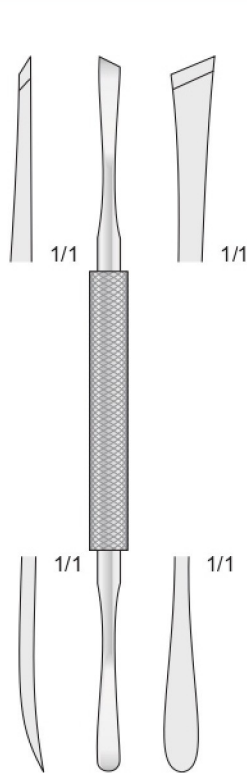

MEAD
165 mm



WEST
185 mm

PERIOSTEAL
ELEVATORS

Scharf - Sharp - Taglienti - Cortante - Tranchant

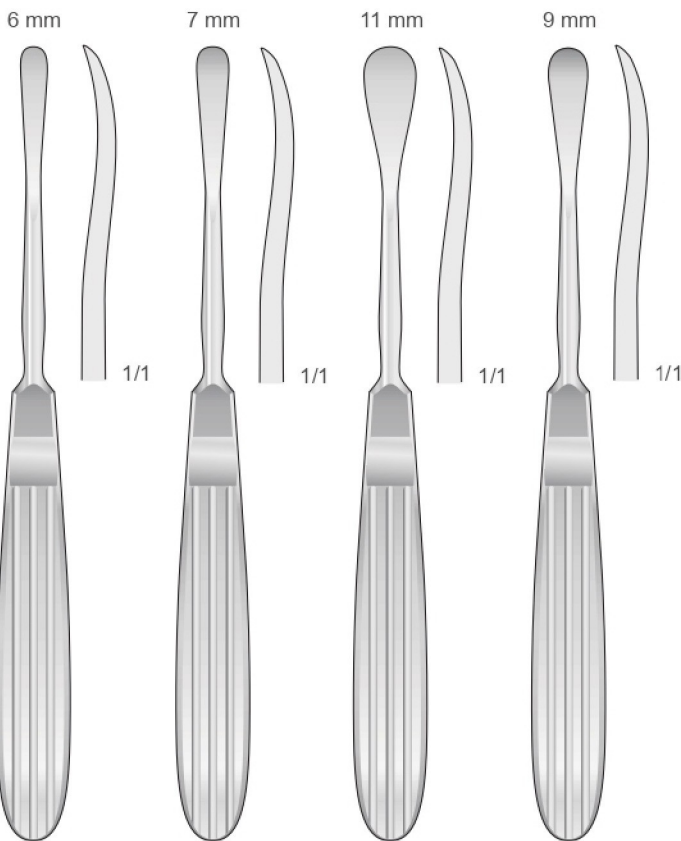

OBWEGESER
DI-DO-59
175 mm

OBWEGESER
DI-DO-63
175 mm

OBWEGESER
DI-DO-65
175 mm

OBWEGESER
DI-DO-67
175 mm

PERIOSTEAL
RASPATORIES

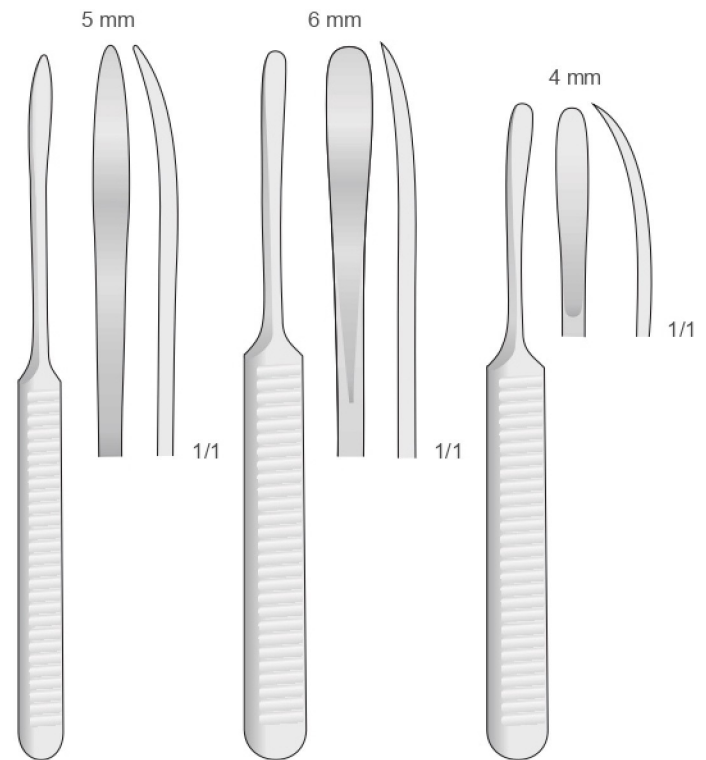

WILLIGER
DI-WG-10
165 mm

WILLIGER
DI-WG-12
160 mm

WILLIGER
DI-WG-14
140 mm



Raspatorien
Periosteals (Raspatories)
Scollaperiostei (Periostotomi)
Periostótomos (Legras)
Rugines périostiques

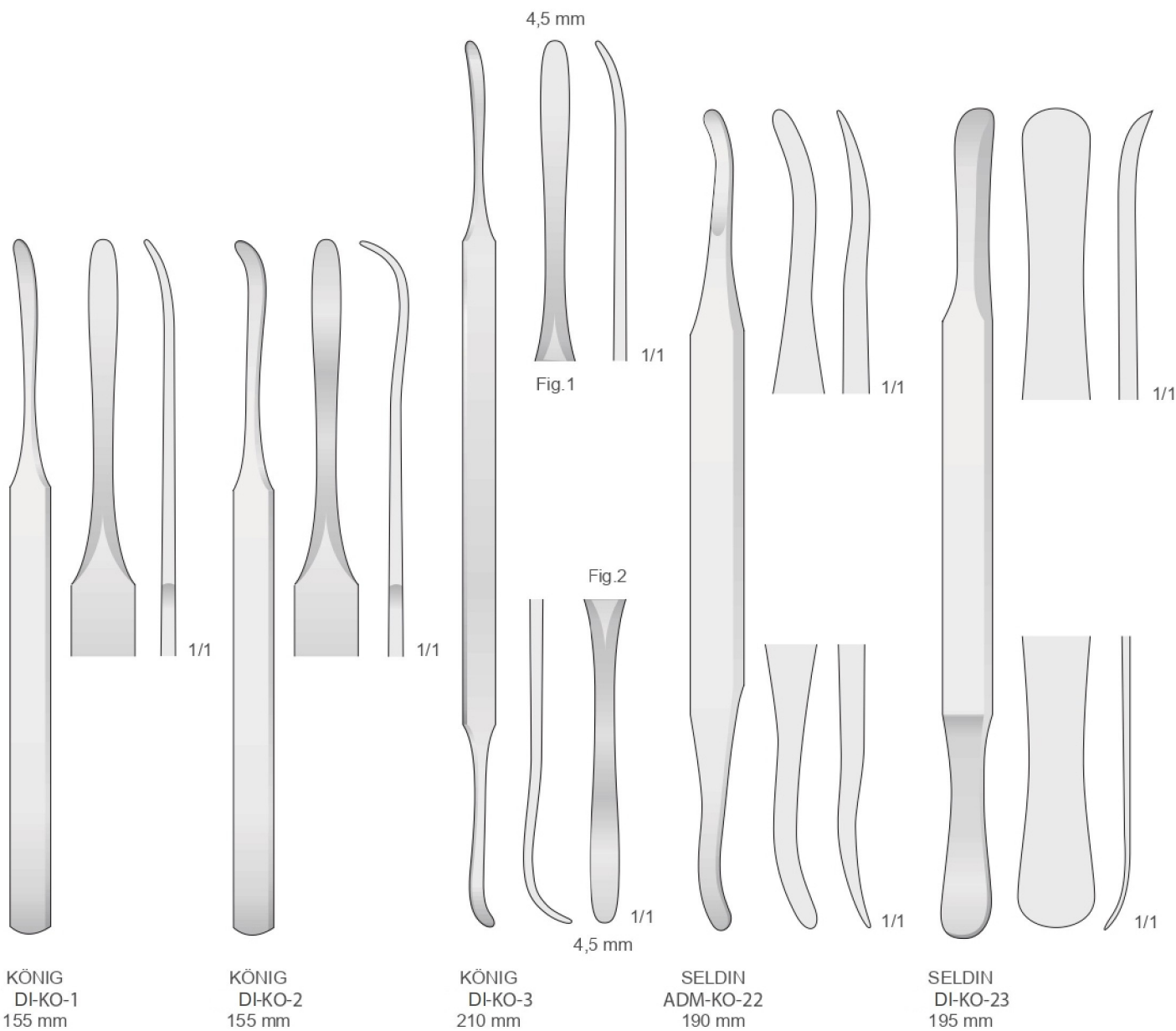



Raspatorien - Elevatorien
Raspatories - Elevators
Periostotomi - Elevatori
Legras - Elevadores
Rugines - Elevateurs

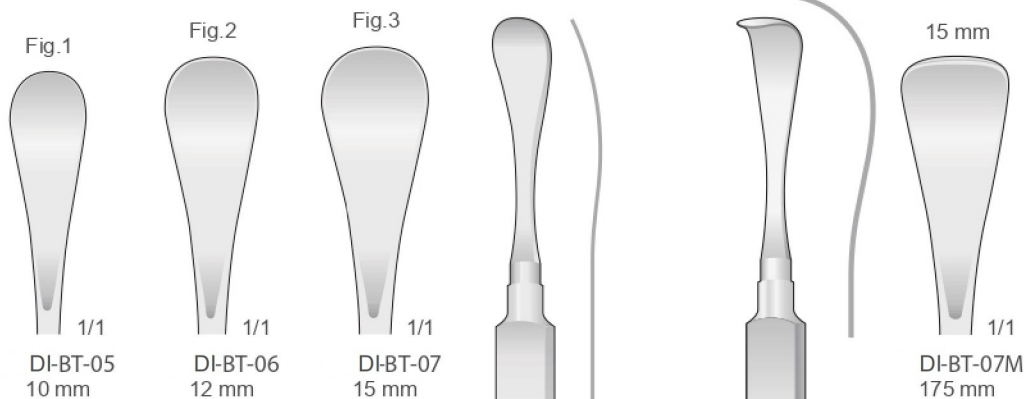

Halbscharf
Semi-Scharp
Semitagliente
Semicortante
Semitranchant

HENAHAN
DI-BT-05/
DI-BT-07
175 mm

HENAHAN
DI-BT-07M
175 mm

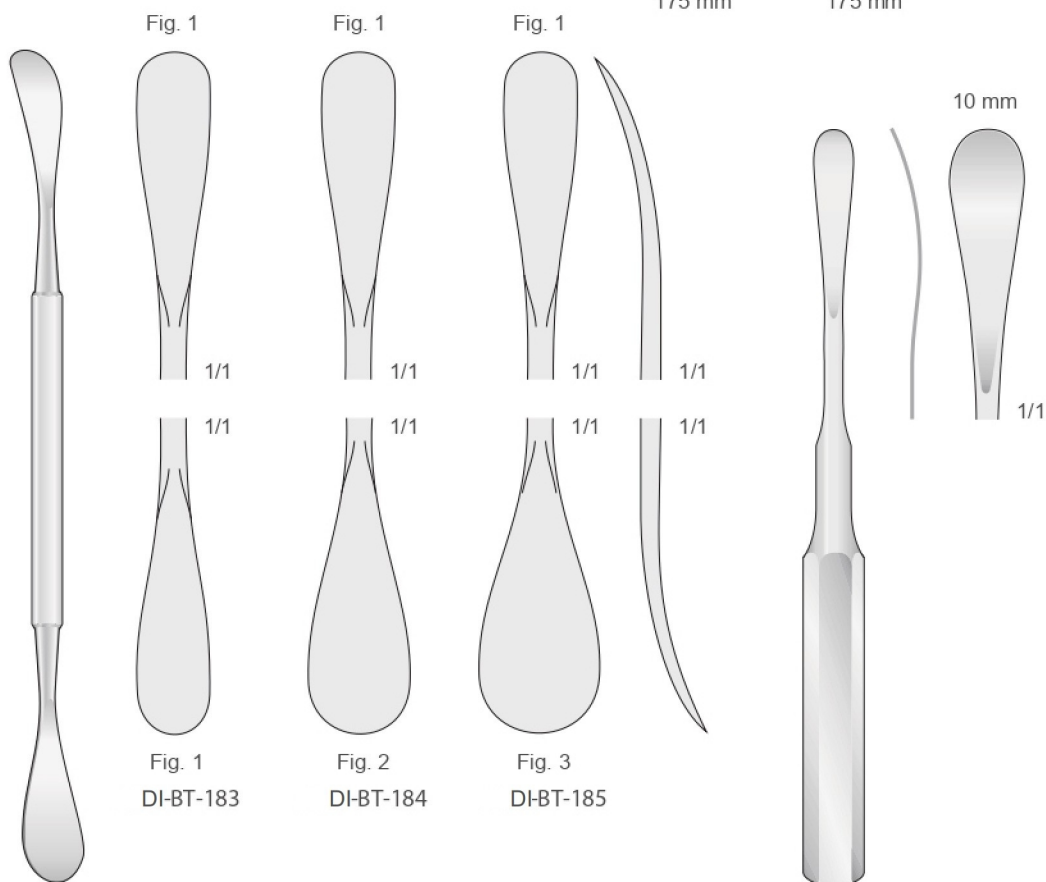

HENAHAN
DI-BT-183/ DI-BT-185
200 mm

MOLT
DI-MO-15
160 mm



Raspatorien - Elevatorien
Raspatories - Elevators
Periostotomi - Elevatori
Legras - Elevadores
Rugines - Elevateurs

Fig. 12S

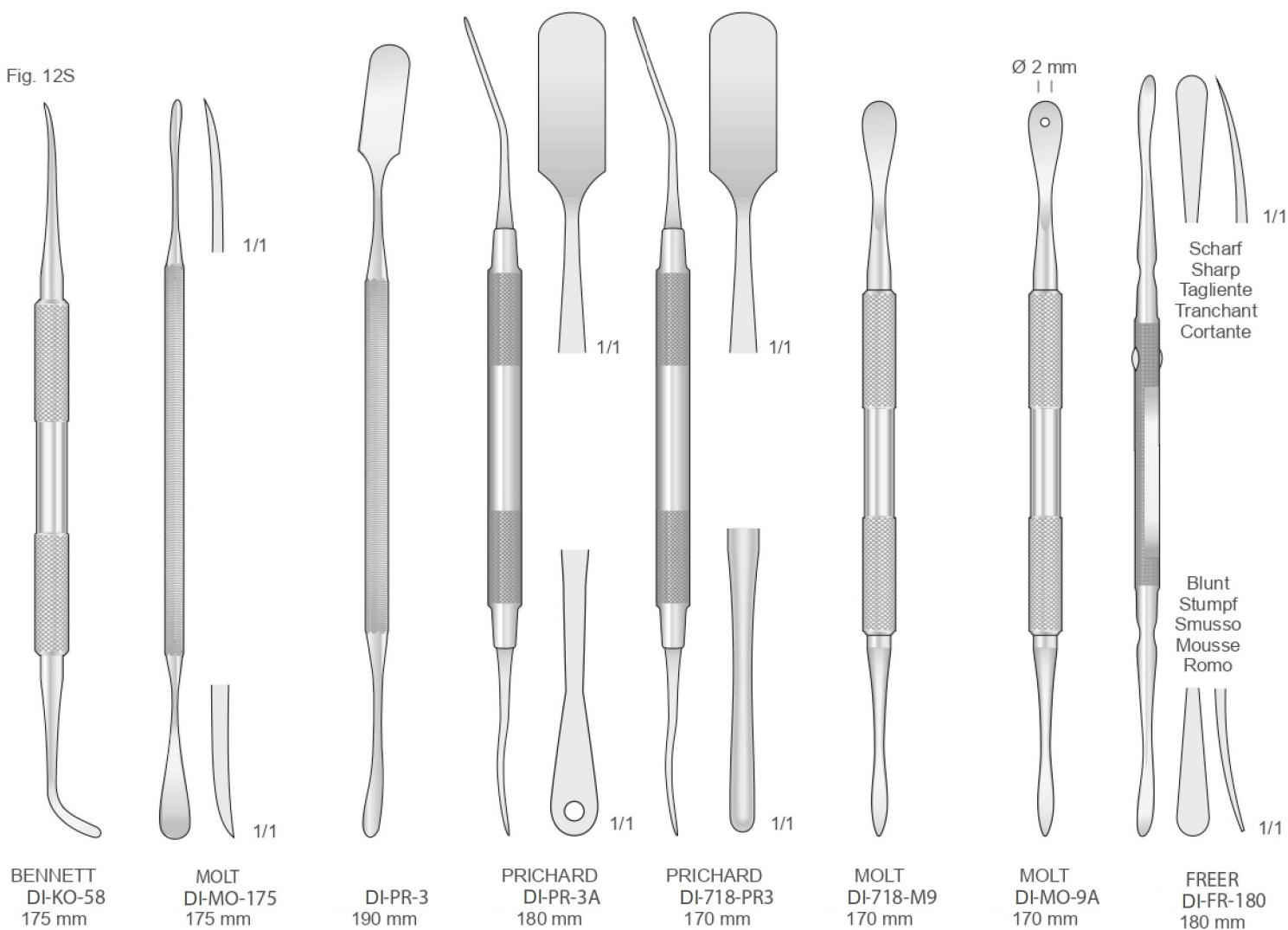

Raspatorien - Elevatoren
Raspatories - Elevators
Periostotomi - Elevatori
Legras - Elevadores
Rugines - Elevateurs

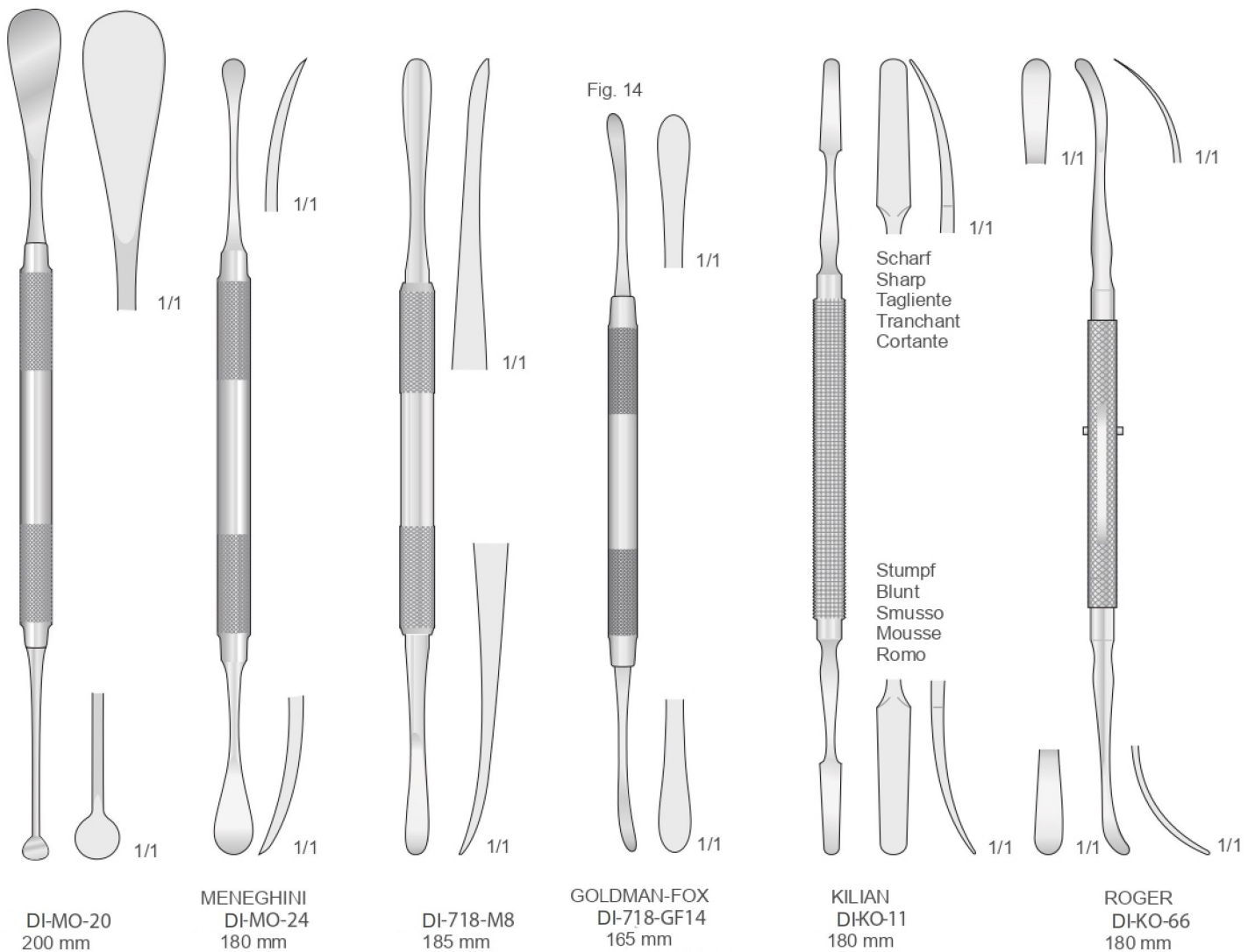



Raspatories - Elevators
Periostotomi - Elevatori
Legras - Elevadores
Rugines - Elevateurs

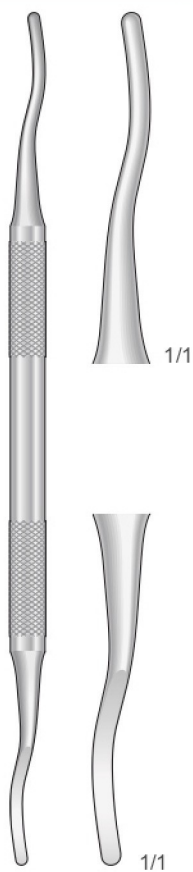

HOPKINS
DI-718-191
185 mm

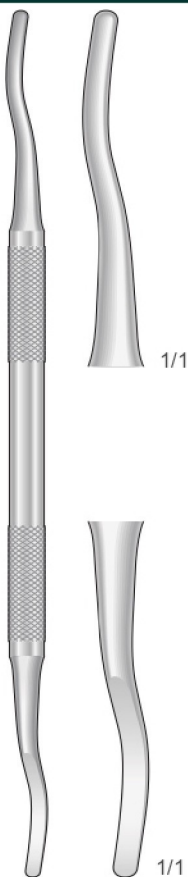

HOPKINS
DI-718-192
185 mm

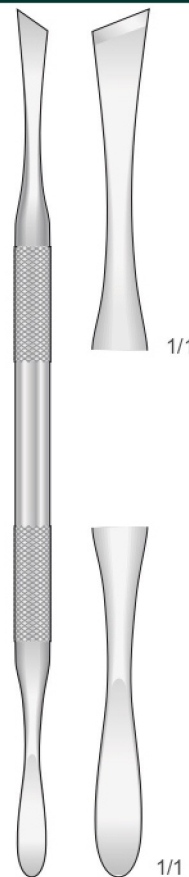

MEAD
DI-718-223
185 mm

Instrumente für Sinuslift / Sinus Lift Instruments / Strumenti per rialzo del seno
Instrumentos para elevación de seno maxilar / Instruments d'élevation sinusienne

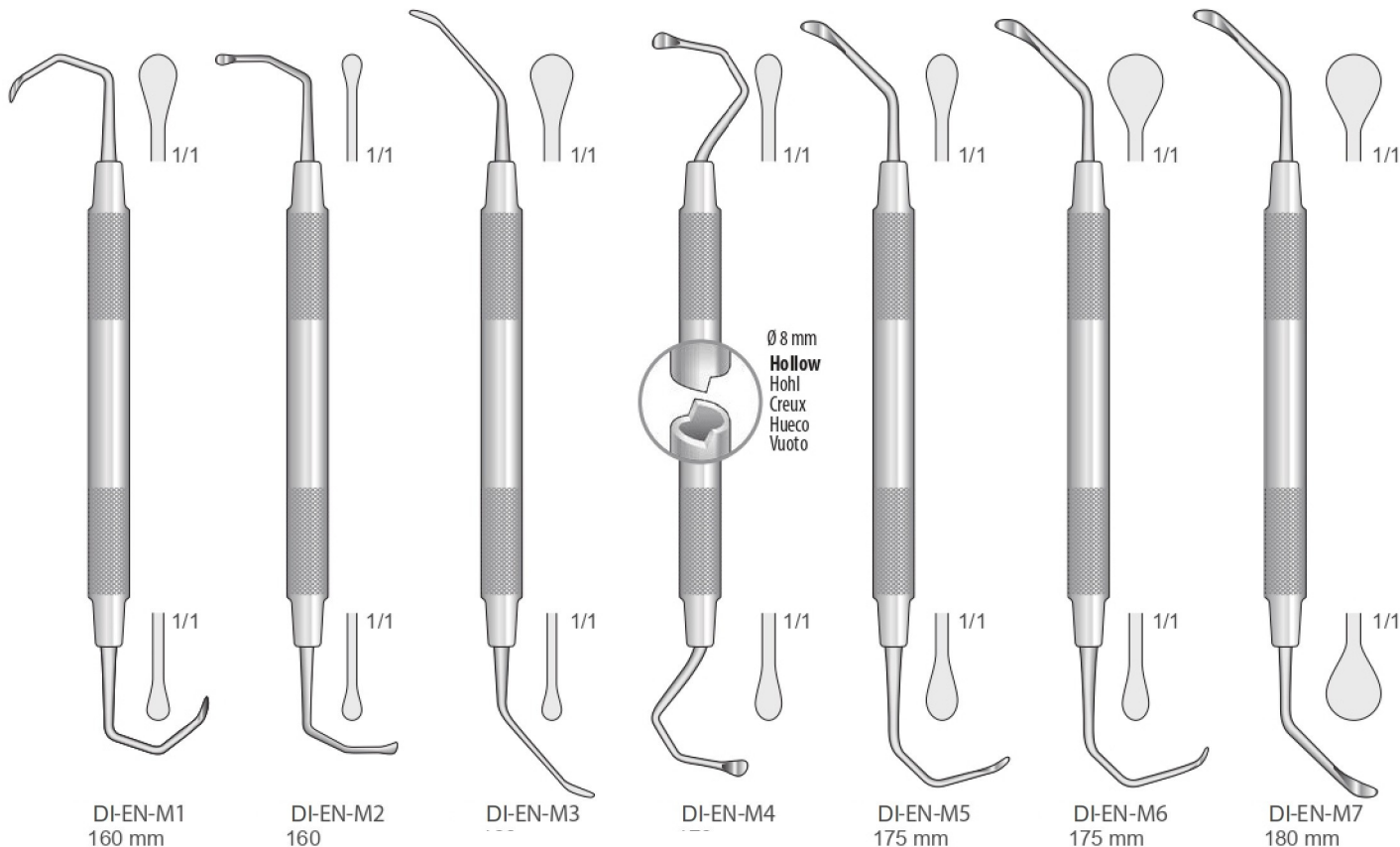



Raspatories - Elevators
Periostotomi - Elevatori
Legras - Elevadores
Rugines - Elevateurs

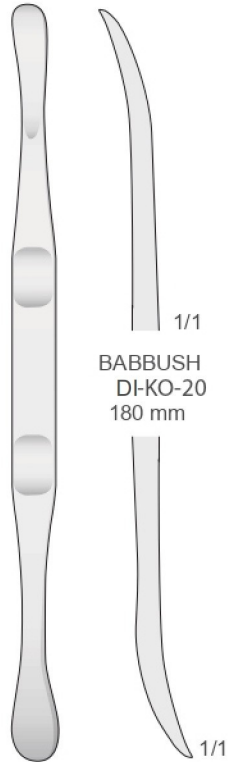

BABBUSH
DI-KO-20
180 mm



1/1
DI-ES-27
160 mm
Stumpf
Blunt
Smusso
Mousse
Romo



1/1
DI-HB
160 mm
Scharf
Sharp
Tagliente
Tranchant
Cortante

Instrumente für Sinuslift
Sinus Lift Instruments

Strumenti per rialzo del seno
Instrumentos para elevación de seno maxilar
Instruments d'élévation sinusienne

Fig. 24G

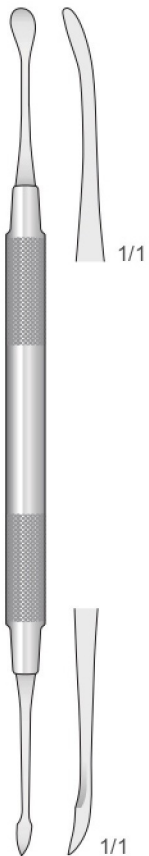

MOLT
DI-MO-8
180 mm



DI-MIR-08
175

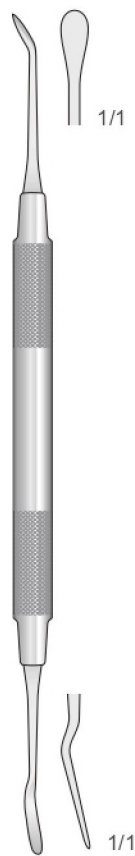

WOODSON
DI-712-241

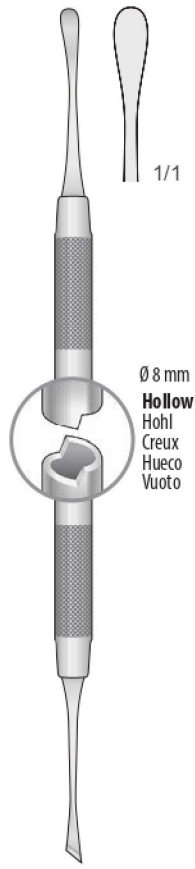

DI-718-24G
175 mm

Ø 8 mm
Hollow
Hohl
Creux
Hueco
Vuoto

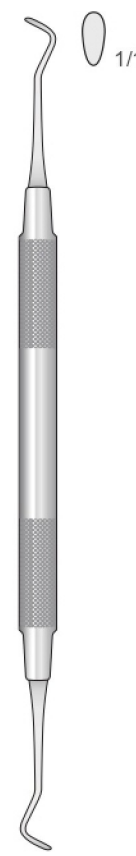

DI-718-EN1
175 mm



DI-718-EN2
165 mm



DI-718-EN3
170 mm



Raspatories - Elevators
Periostotomi - Elevatori
Legras - Elevadores
Rugines - Elevateurs

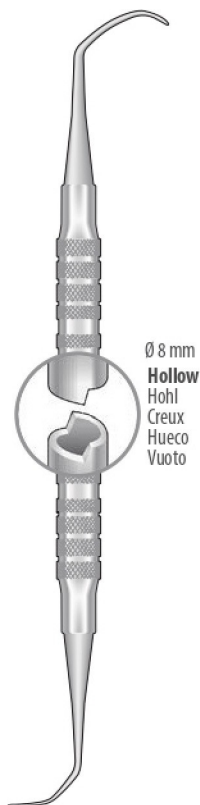

Ø 8 mm
Hollow
Hohl
Creux
Hueco
Vuoto

DI-TASO-1

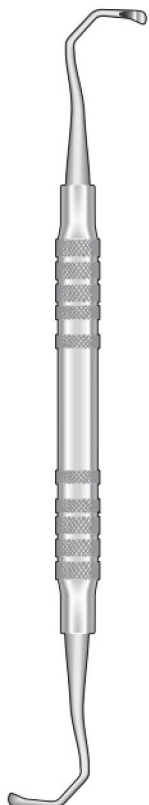

DI-TASO-2



DI-TASO-3



DI-TASO-4



DI-TASO-5



DI-TASO-6



DI-TASO-7



Ø 8 mm
Hollow
Hohl
Creux
Hueco
Vuoto

DI-TASO-8



Raspatorien
Raspatories
Periostotomi
Legras
Rugines

Curettes
Küretten
Curettes
Curetas
Curettes

Instrumente für Sinuslift
Sinus Lift Instruments
Strumenti per rialzo del seno
Instrumentos para elevación de seno maxilar
Instruments d'élevation sinusienne

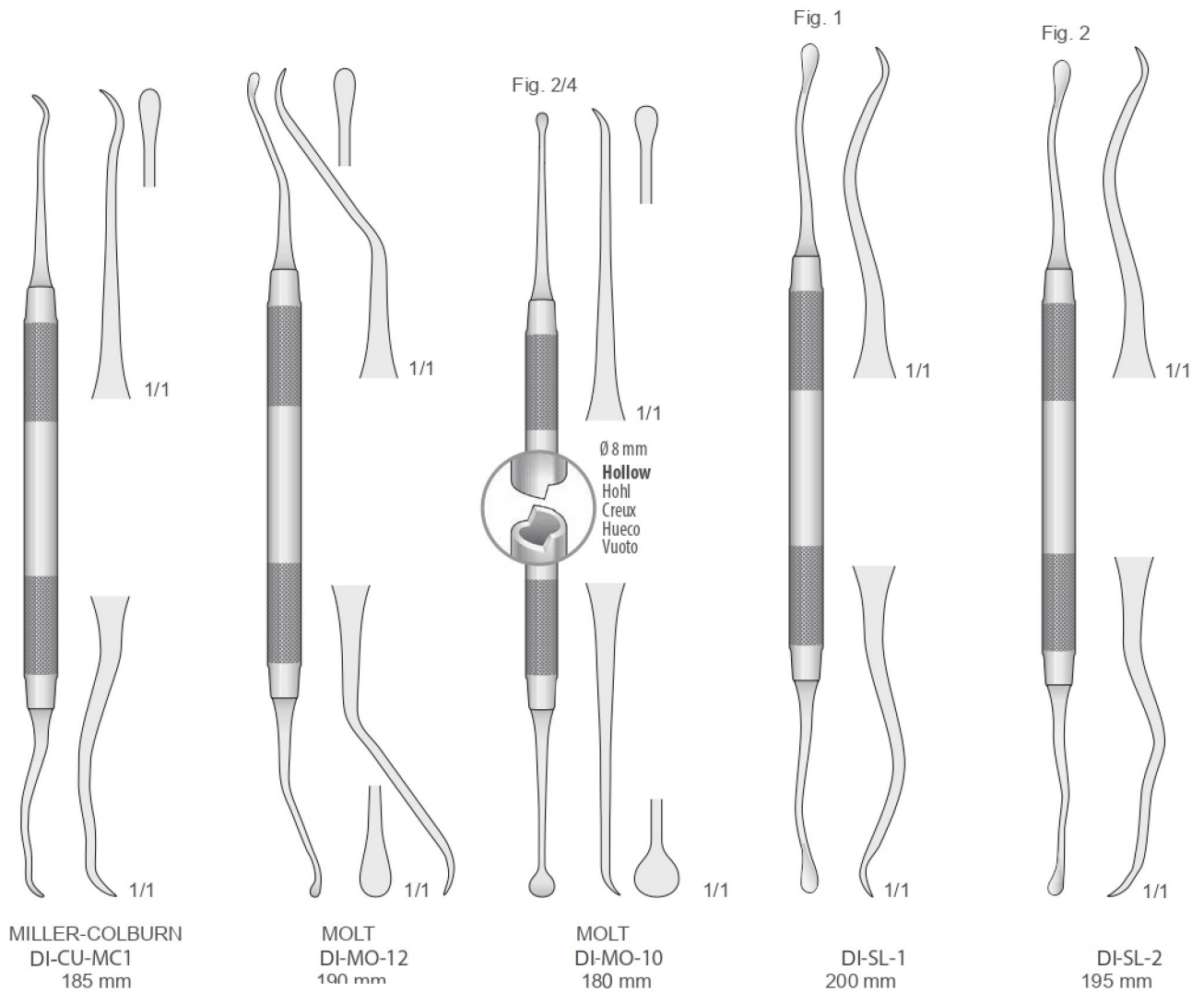



Küretten
Curettes
Curettes
Curetas
Curettes

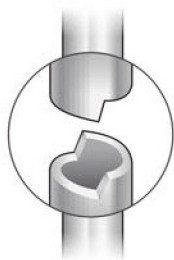

Runder Hohlgriff 8 mm
Hollow Round Handle 8 mm
Manico tondo vuoto 8 mm
Mango hueco 8 mm
Manche rond vide 8 mm

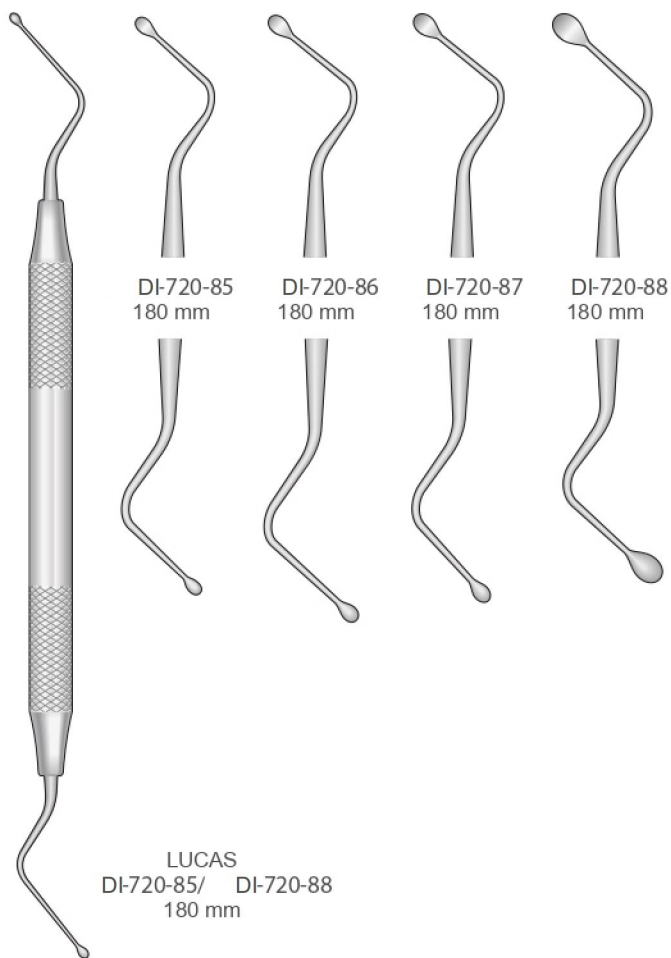
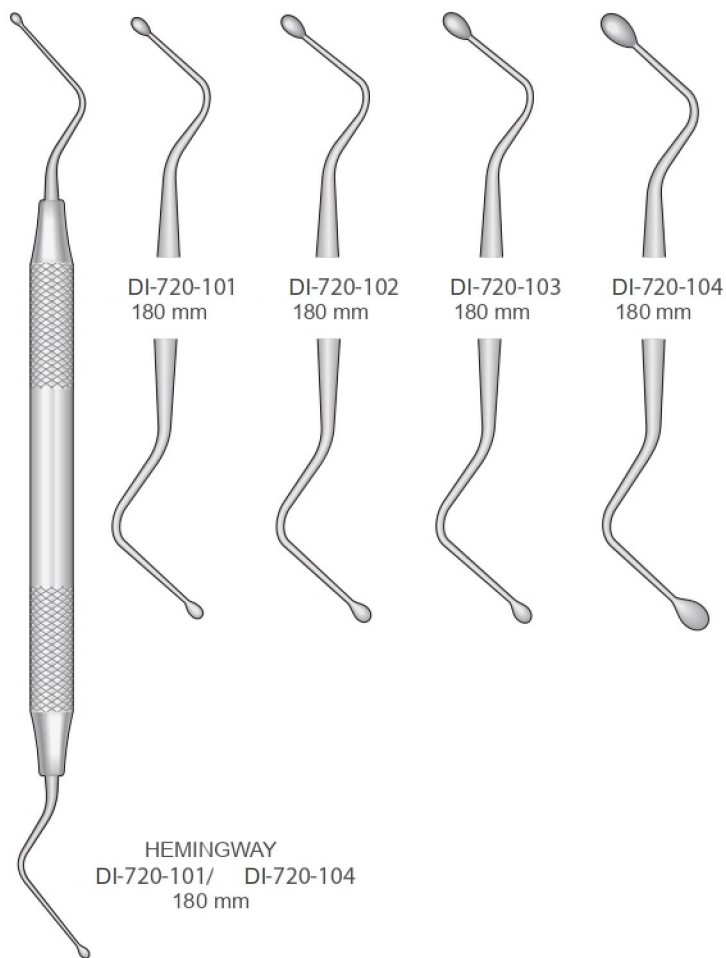



Küretten
Curettes
Curettes
Curetas
Curettes



HEMINGWAY
DI-C-1
170 mm



HEMINGWAY
DI-C-2
170 mm



HEMINGWAY
DI-C-3
170 mm

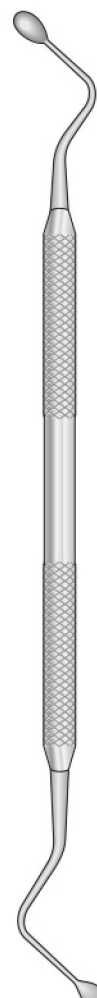

HEMINGWAY
DI-C-4
170 mm

Wundhachen Mandibular
Mandibular Nerve Diplace
Per spostamento
nervo mandibolare
Para nero mandibular

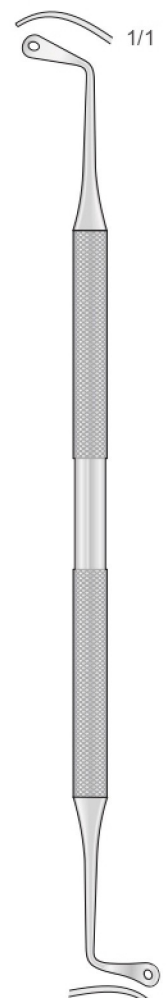

DI-SL-21
165 mm



Küretten
Curettes
Curettes
Curetas
Curettes

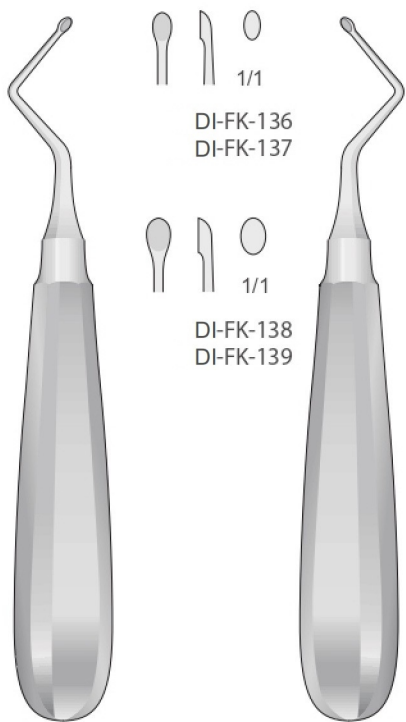

KERPEL
DI-FK-136
DI-FK-138
145 mm

KERPEL
DI-FK-137
DI-FK-139
145 mm



DI-DL-50
155 mm



DI-DL-51
150 mm



DI-DL-52
150 mm

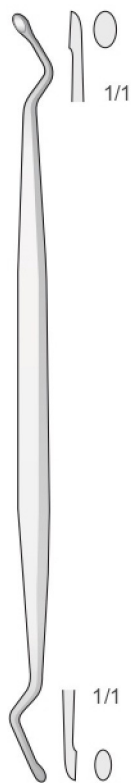

DI-FK-83
160 mm

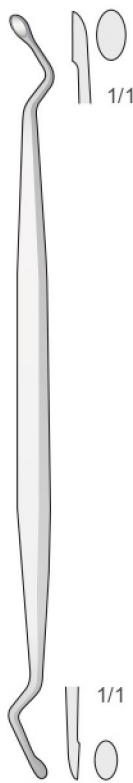

JANSEN
DI-FK-84
160 mm

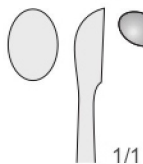

UFFENDORDE
DI-FK-188
170 mm

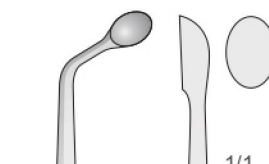

UFFENDORDE
DI-FK-189
170 mm

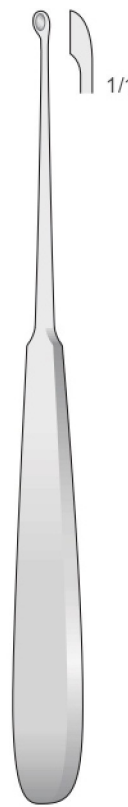

WILLIGER
DI-FK-197/ DI-FK-198
170 mm

Fig. 00
3,4 mm



1/1
DI-FK-197

Fig. 1
5,2 mm



1/1
DI-FK-198



Küretten
Curettes
Curettes
Curetas
Curettes

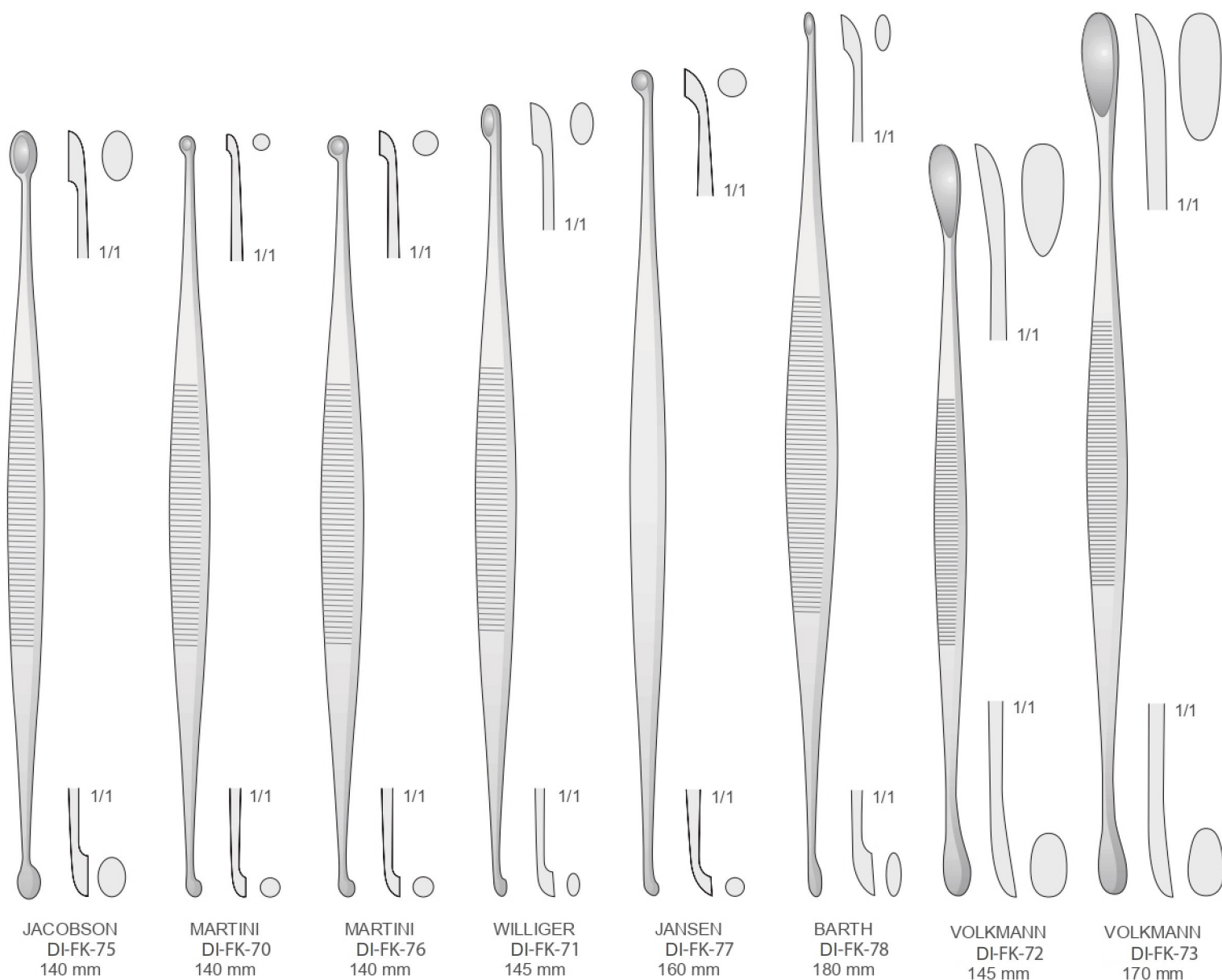



Curettes
Curettes
Curetas
Curettes



- | | | | |
|---------------------------------------|--------------------------------------|-------------------------------------|-------------------------------------|
| Fig.0000
2,8 mm
1/1
DI-FK-60 | Fig.000
3,6 mm
1/1
DI-FK-61 | Fig.00
4,4 mm
1/1
DI-FK-62 | Fig.0
5,2 mm
1/1
DI-FK-63 |
| Fig.1
6,8 mm
1/1
DI-FK-64 | Fig.2
8,5 mm
1/1
DI-FK-65 | Fig.3
10 mm
1/1
DI-FK-66 | Fig.4
11,5 mm
1/1
DI-FK-67 |



VOLKMAN
DI-FK-60/ DI-FK-67
170 mm

COLLEGE CURETTE
DI-MIR-10
160 mm



- | | | |
|---------------------------|--------------------------|---------------------------|
| 3 mm
1/1
DI-FK-110 | 4 mm
1/1
DI-FK-111 | 5 mm
1/1
DI-FK-112 |
| 6 mm
1/1
DI-FK-113 | 8 mm
1/1
DI-FK-114 | 12 mm
1/1
DI-FK-116 |
| 10 mm
1/1
DI-FK-115 | | |



- | | | |
|----------------------------|----------------------------|----------------------------|
| 2,5 mm
1/1
DI-FK-120 | 3,4 mm
1/1
DI-FK-121 | 4,2 mm
1/1
DI-FK-122 |
| 5,2 mm
1/1
DI-FK-123 | | 6,3 mm
1/1
DI-FK-124 |
| 7,4 mm
1/1
DI-FK-125 | | 8 mm
1/1
DI-FK-126 |

BRUNS
DI-FK-110/ DI-FK-116
165 mm

SCHEDÉ
DI-FK-120/ DI-FK-126
170 mm



Chirurgische Kuretten
Surgical Curettes
Curette chirurgiche
Curetas quirúrgicas
Curettes chirurgicales

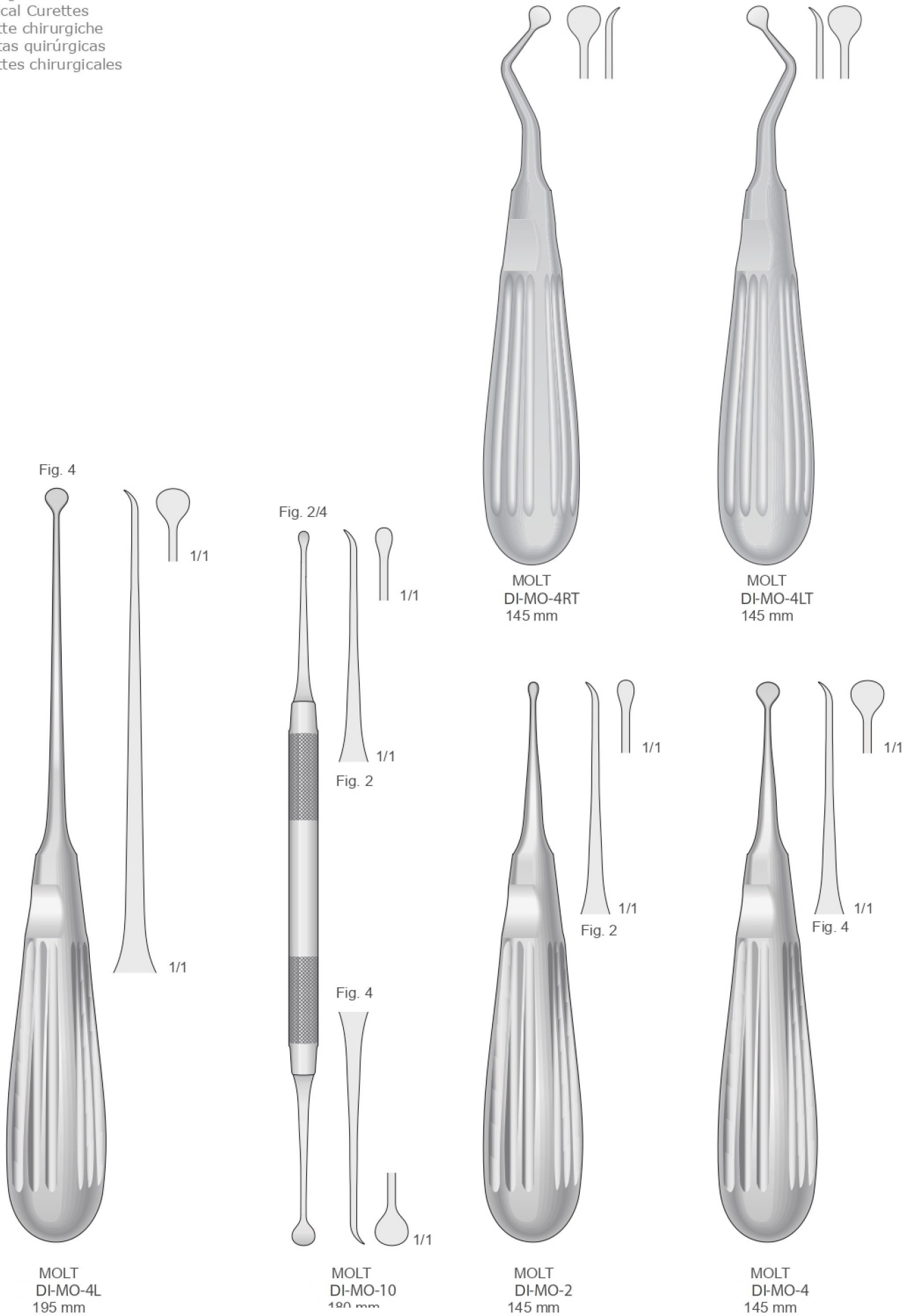



Knochenfeilen
Bone Files
Lime per osso
Limas para hueso
Limes à os

Fig. 67

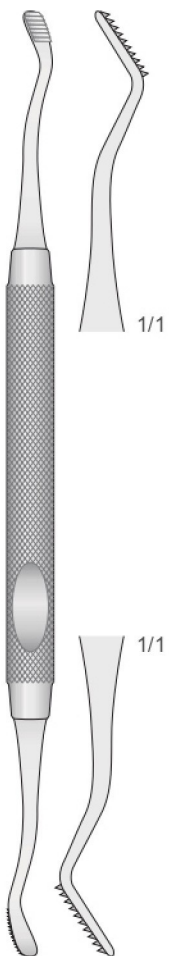

HOWARD
DI-DO-1
180 mm

Fig. 45

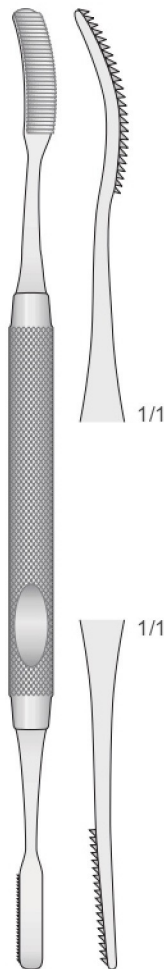

MILLER
DI-DO-2
185 mm

Fig. 52

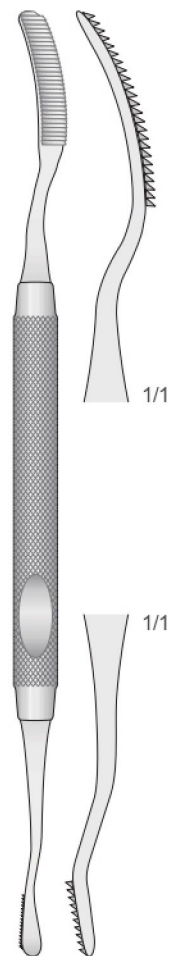

MILLER
DI-DO-3
180 mm

Fig. 12

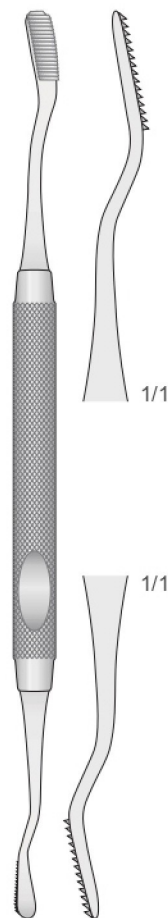

HOWARD
DI-DO-4
170 mm

Fig. 12A

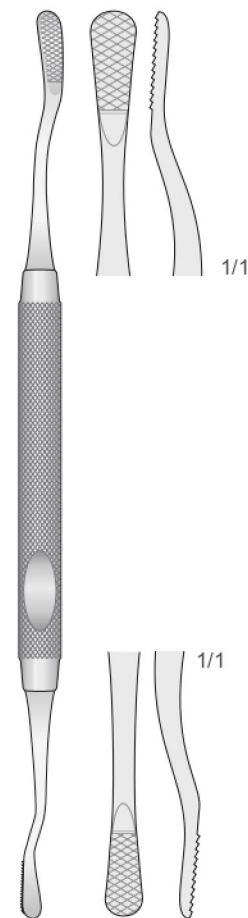

MILLER
DI-DO-4C
170 mm

Fig. 64

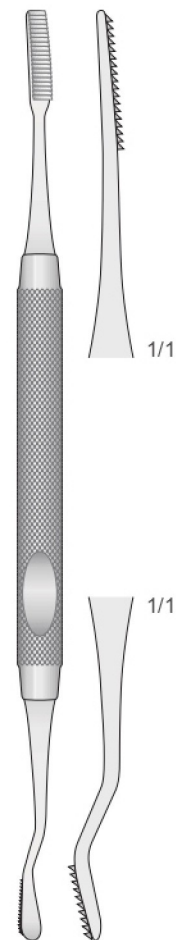

MILLER
DI-DO-5
175 mm



Knochenfeilen
Bone Files
Lime per osso
Limas para hueso
Limes à os

Runder Hohlgriff 8 mm
Hollow Round Handle 8 mm
Manico tondo vuoto 8 mm
Mango hueco 8 mm
Manche rond vide 8 mm

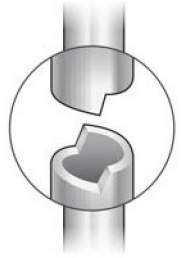

Parodontal Feilen
Periodontal Files
Lime parodontali
Limas periodontales
Limes parodontales

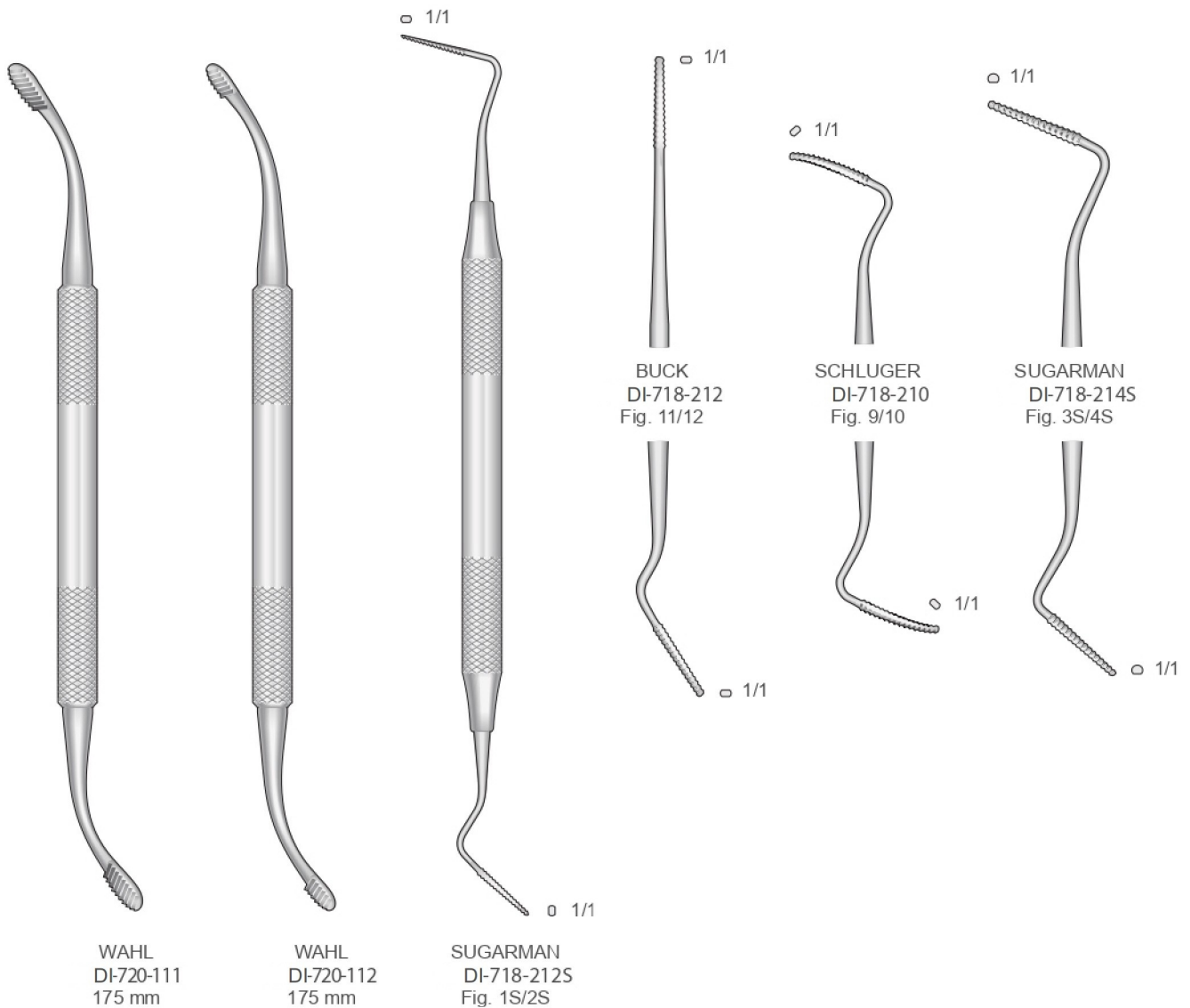



Gewebezangchen
Tissue Nippers
Tronchesi per gengive e tessuti
Pinzas para cortar tejidos
Pincas coupante pour tissue

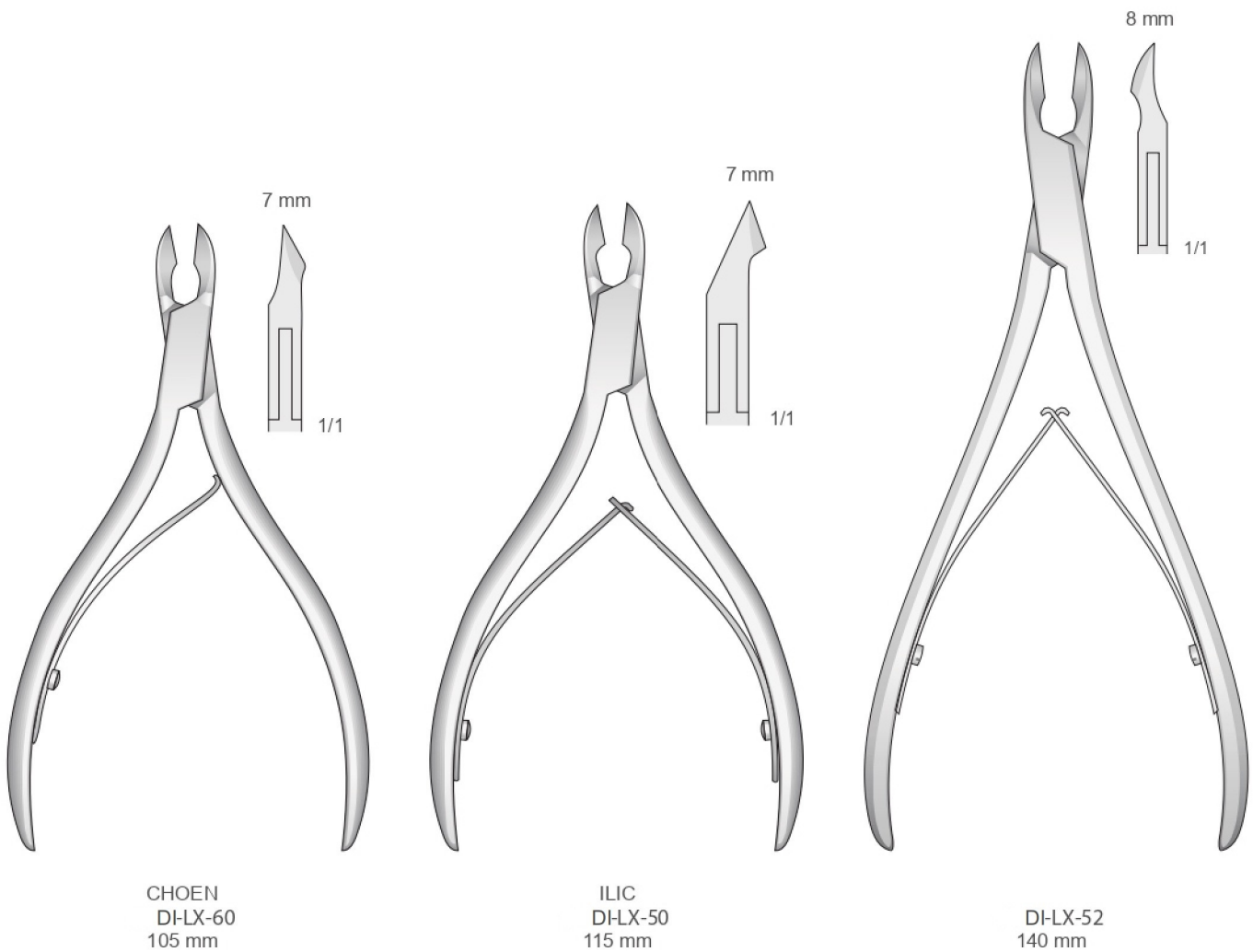



Hohlmeißelzangen
Bone rongeurs
Pinze ossivore
Pinzas gubias
Pincas gouges

S-Form

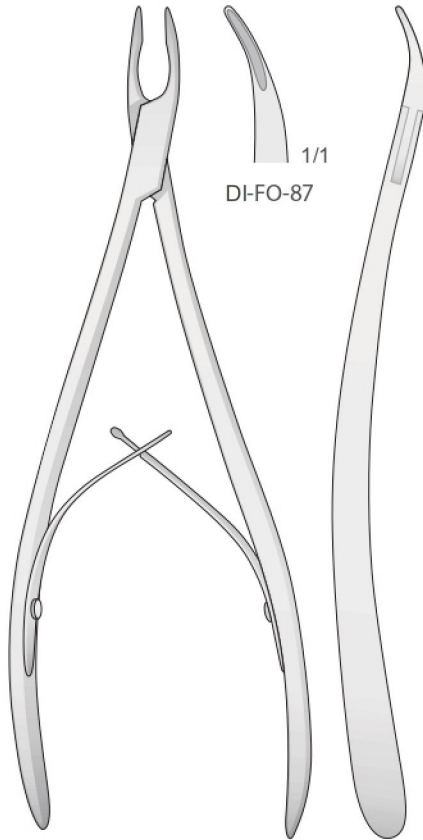

DI-FO-87
1/1

STELLBRINK
DI-FO-87
190 mm

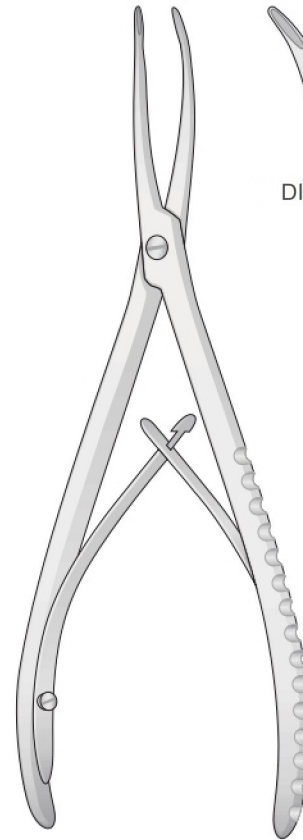

DI-FO-88
1/1

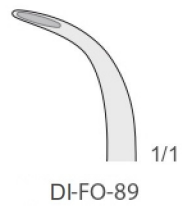

DI-FO-89
1/1

STELLBRINK
DI-FO-88/ DI-FO-89
170 mm

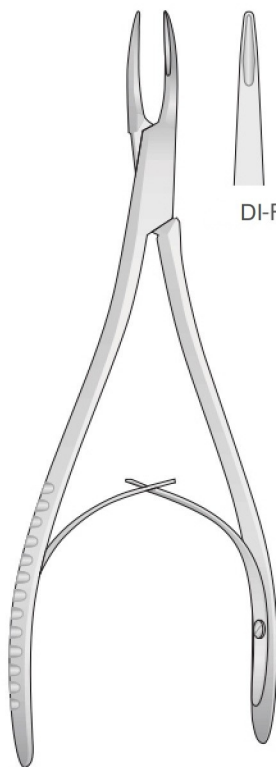

DI-FO-23
1/1

DI-FO-22
1/1
30°

DI-FO-220
1/1
45°

DI-FO-24
1/1
90°

MINI-FRIEDMANN
DI-FO-22/ DI-FO-220
150 mm

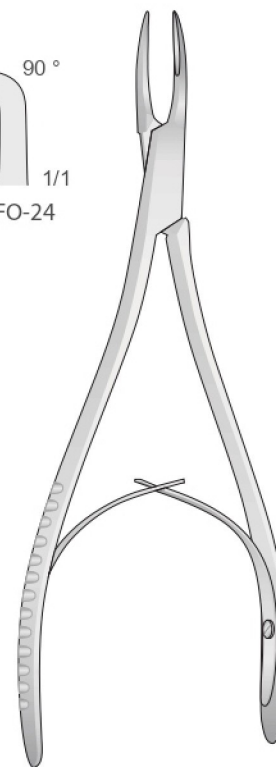

S-Form

DI-FO-85
1/1
30°

MINI-FRIEDMANN
DI-FO-85
145 mm



Hohlmeißelzangen
Bone rongeurs
Pinze ossivore
Pinzas gubias
Pincas gouges

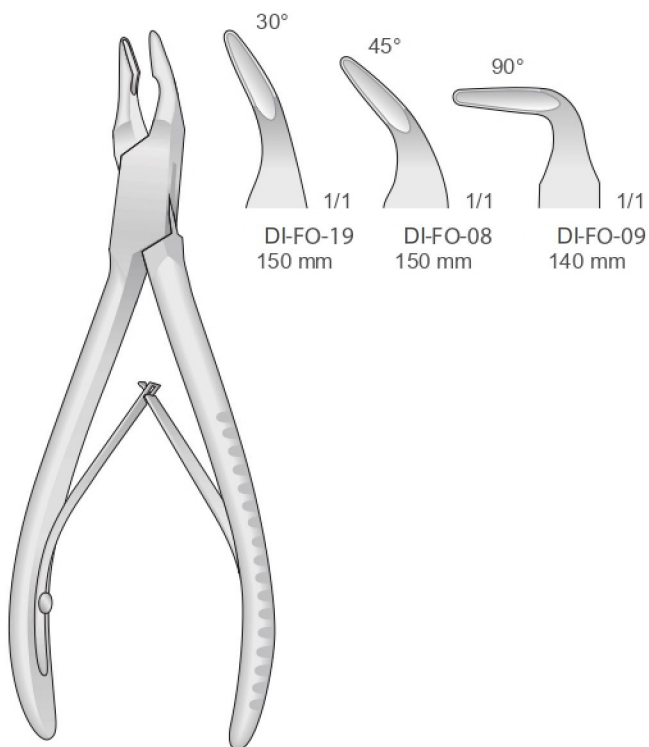

BLUMENTHAL
DI-FO-08/ DI-FO-19

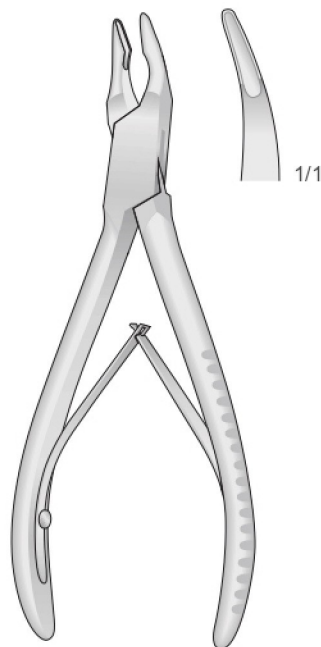

MINI FRIEDMAN
DI-FO-15
120 mm

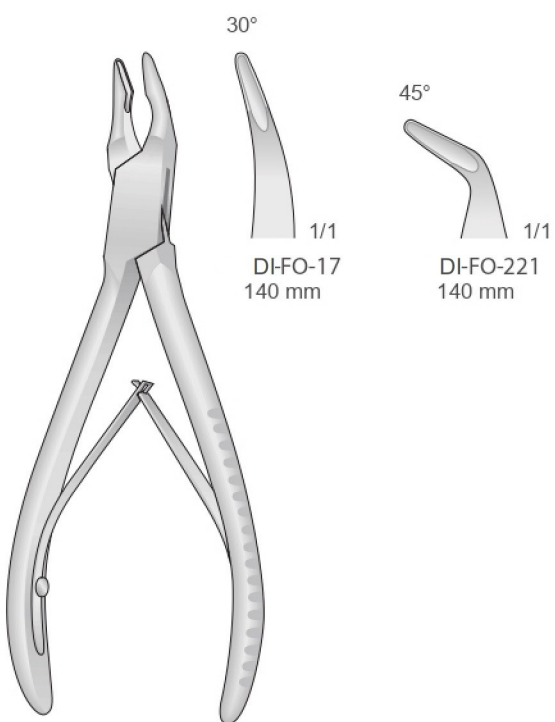

FRIEDMANN
DI-FO-17/ DI-FO-221
140 mm

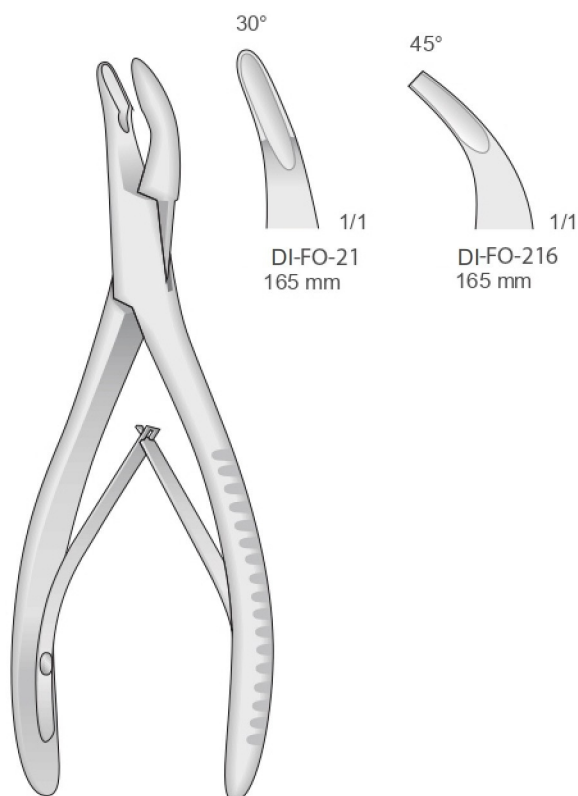

MEAD
DI-FO-21/ DI-FO-216
165 mm



Hohlmeißelzangen
Bone rongeurs
Pinze ossivore
Pinzas gubias
Pincas gouges

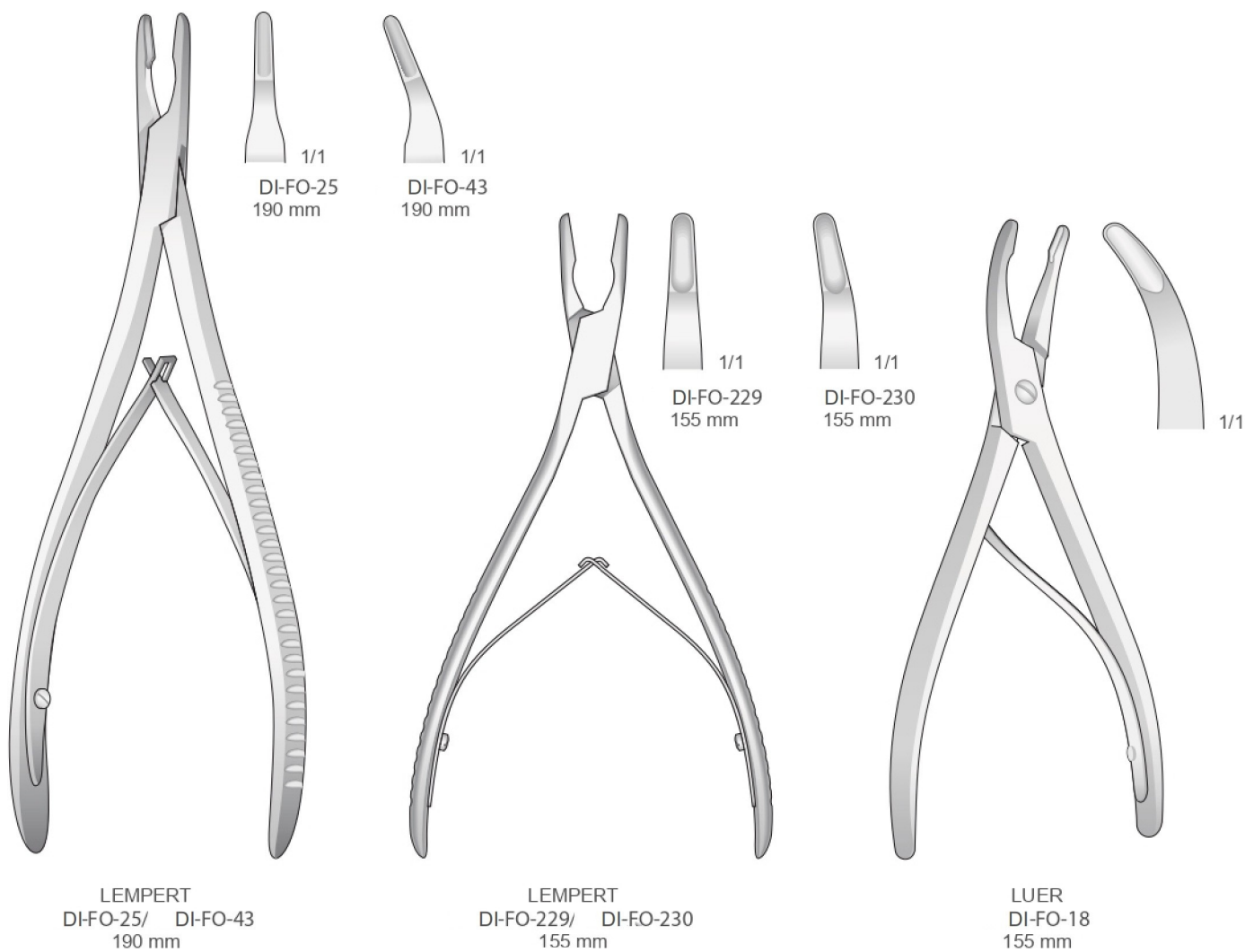



Hohlmeißelzangen
Bone rongeurs
Pinze ossivore
Pinzas gubias
Pincas gouges

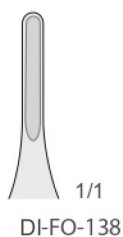
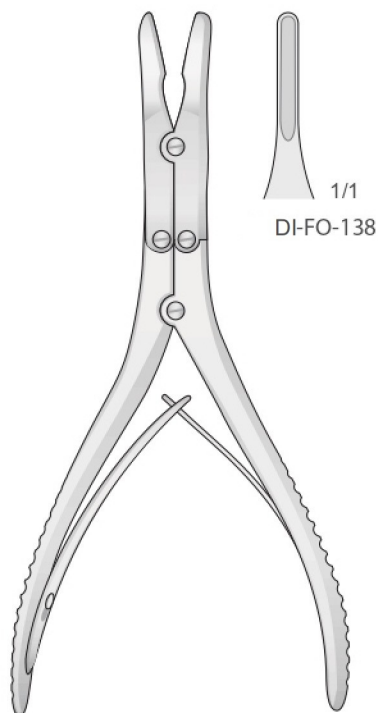

1/1
DI-FO-138

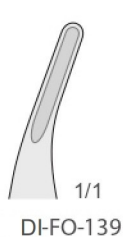
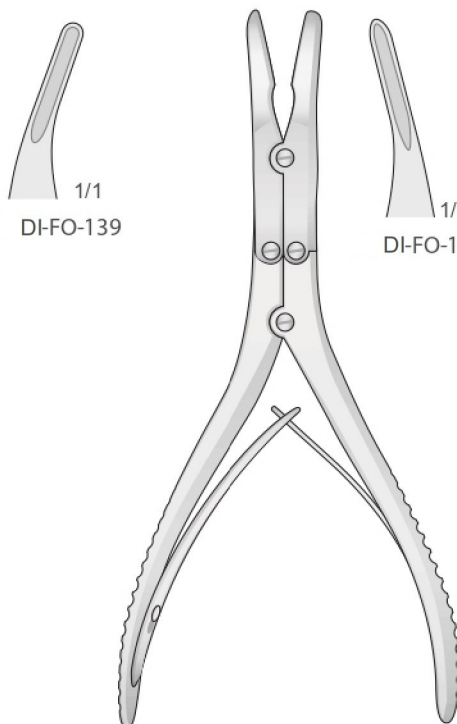

1/1
DI-FO-139

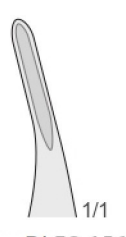

1/1
DI-FO-156

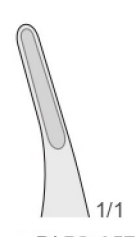

1/1
DI-FO-157

RUSKIN
DI-FO-138/ DI-FO-139
150 mm

KLEINERT-KUTZ
DI-FO-156/ DI-FO-157
155 mm

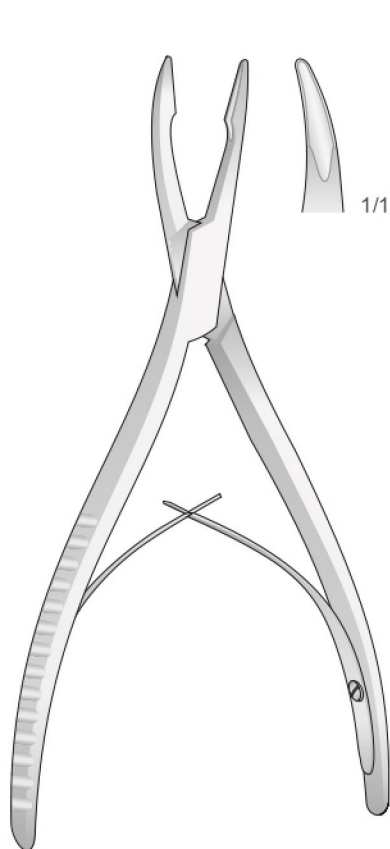

1/1

FRIEDMANN
DI-FO-16
160 mm

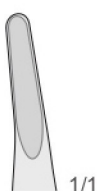
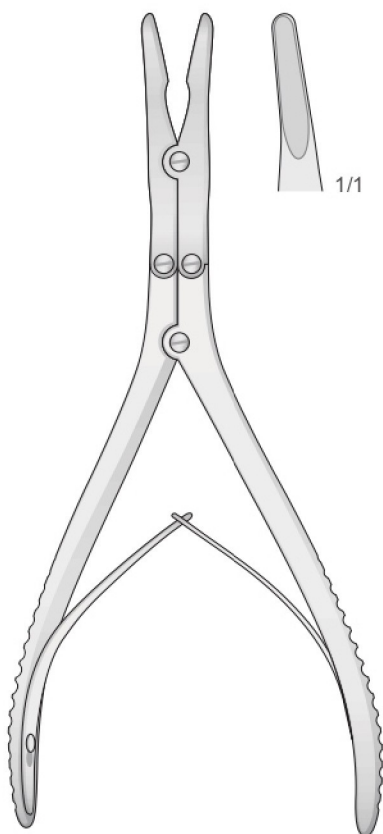

1/1

BEYER
DI-FO-20
180 mm

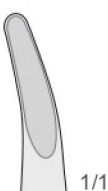
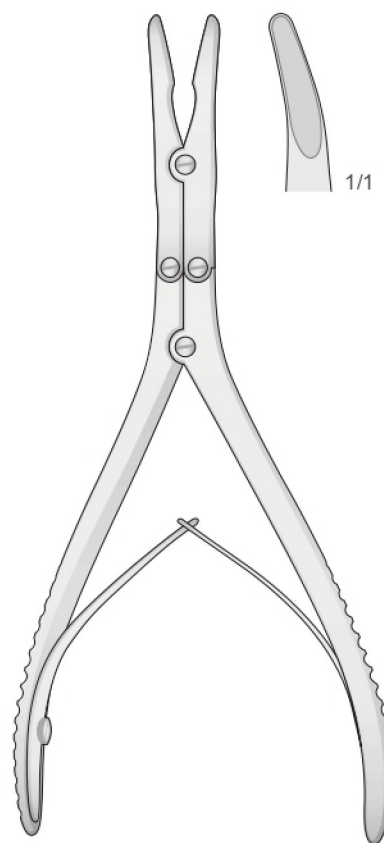

1/1

ZAUFAL-JANSEN
DI-FO-34
180 mm



Hohlmeißelzangen
Bone rongeurs
Pinze ossivore
Pinzas gubias
Pincas gouges

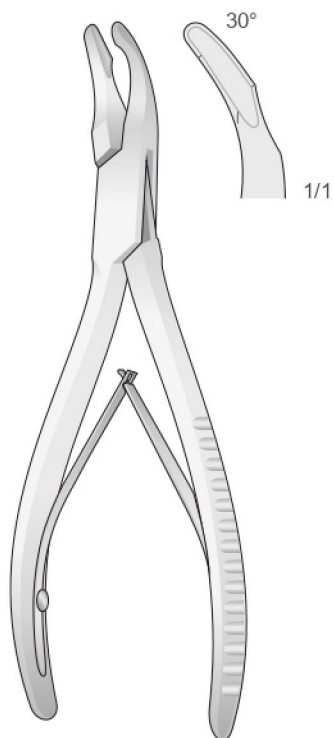

CLEVELAND
DI-FO-231 140 mm
DI-FO-232 170 mm

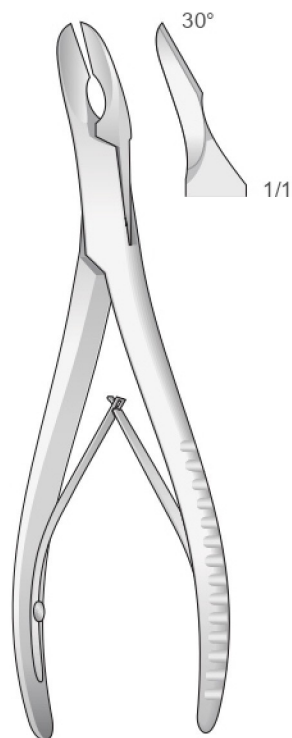

CLEVELAND
DI-FO-233 150 mm
DI-FO-234 170 mm

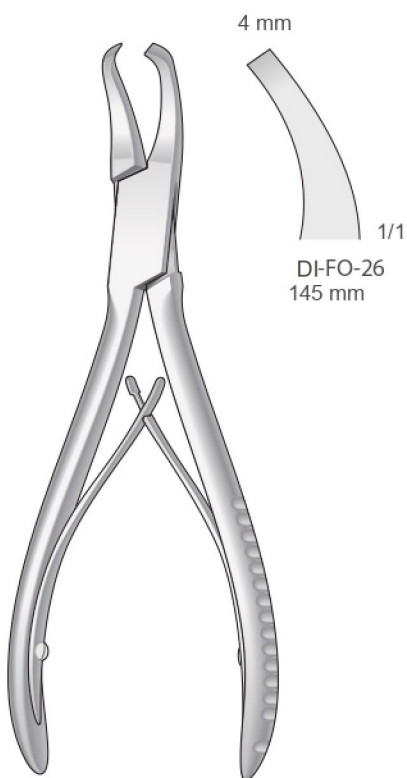

GARDNER
DI-FO-26/ DI-FO-77
145 mm

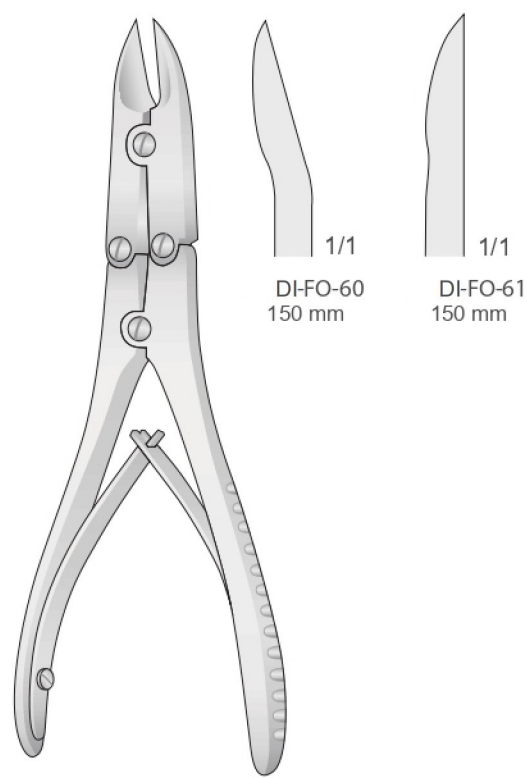
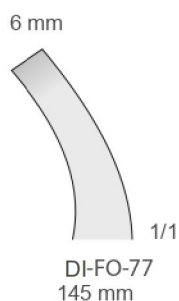

BÖHLER
DI-FO-60/ DI-FO-61
150 mm



Knochensplitterzangen

Bone cutting forceps

Pinze ossivore

Pinzas cortantes para huesos

Pinces coupantes à os

Punches - Stanzen

Bone cutting forceps
for opening the Sinus
Strumento tagliente per
aumentare il volume del seno

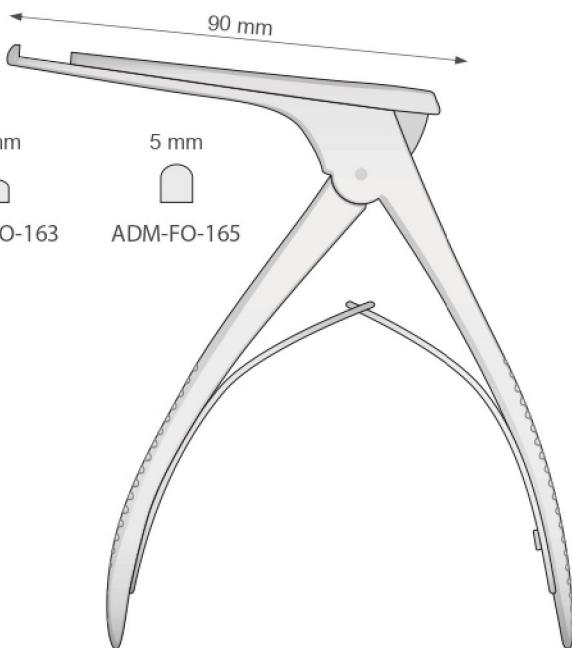

2 mm



3 mm



5 mm



KERRISON
DI-FO-162 2 mm
DI-FO-163 3 mm
DI-FO-165 5 mm

Bone cutting forceps
for opening the Sinus
Strumento tagliente per
aumentare il volume del seno

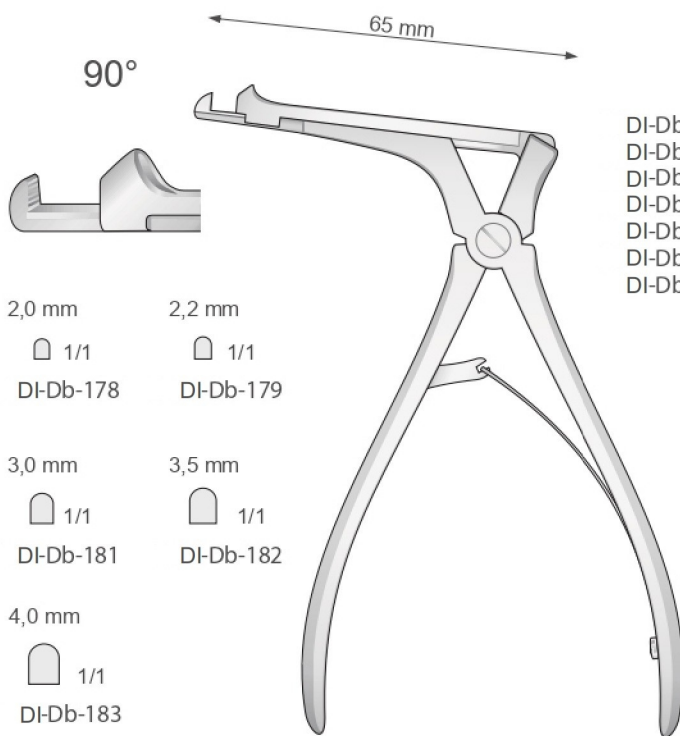

1,5 mm



DI-Db-177

2,0 mm



DI-Db-178

2,2 mm



DI-Db-179

2,5 mm



DI-Db-180

3,0 mm



DI-Db-181

3,5 mm



DI-Db-182

4,0 mm



DI-Db-183

DI-Db-177 1,5 mm
DI-Db-178 2,0 mm
DI-Db-179 2,2 mm
DI-Db-180 2,5 mm
DI-Db-181 3,0 mm
DI-Db-182 3,5 mm
DI-Db-183 4,0 mm

CITELLI
DI-Db-177/ DI-Db-183

Fig.
R-18

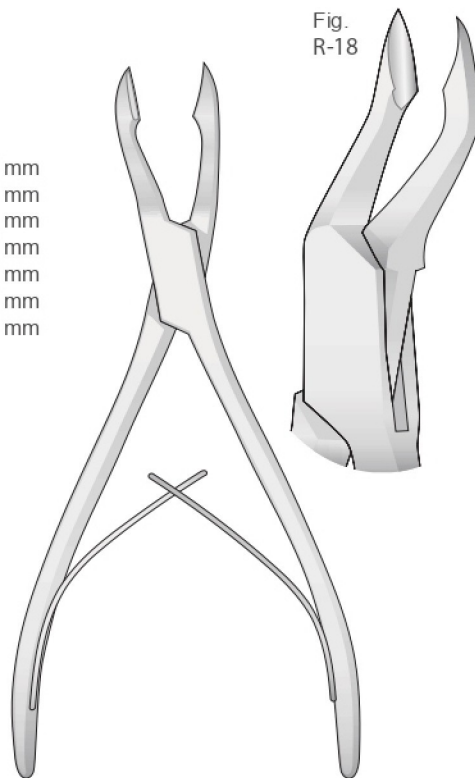

DI-FO-33
175 mm