

DENTAL INSTRUMENTS CATALOGUE



Needle Holders



ISO
9001:2008



ایران صنعت و تجارت سہیل کوٹ



Health Fast Surgical
Surgical Manufacturer Company



Nadelhalter
Needle Holders
Port'aghi
Portaagujas
Porte aiguilles

Mit Scheren
With Scissor
Con forbice
Con tijeras
Avec ciseaux

Glattes Maul
Smooth Jaw
Morso liscio
Mandibula lisa
Mors lisse

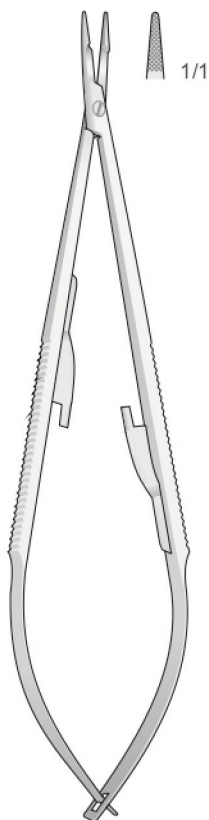

DI-FD-26
140 mm

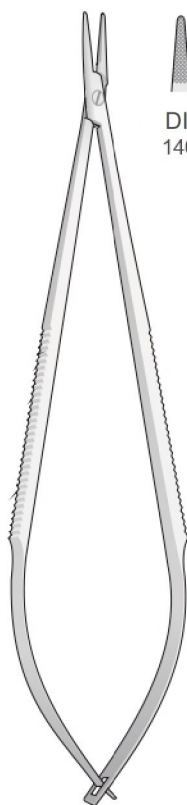

DI-FD-14/ DI-FD-16
140 mm

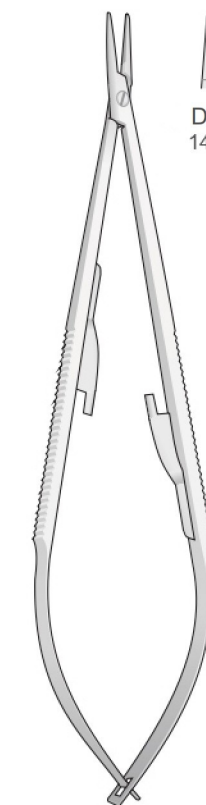
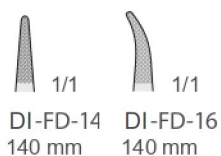

CASTROVIEJO
DI-FD-17/ADM-FD-19
140 mm

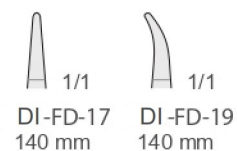



Nadelhalter
Needle Holders
Port'aghi
Portaagujas
Porte aiguilles

Mit Locking-System
With Locking System (stop)
Con sistema di bloccaggio
Con sistema de bloqueo
Avec système de verrouillage

Glattes Maul
Smooth Jaw
Morso liscio
Mandibula lisa
Mors lisse

Feingerieftes Maul
Fine serrated jaws
Morso zigrinato fine
Mandibula estriada fina
Mors strié fin

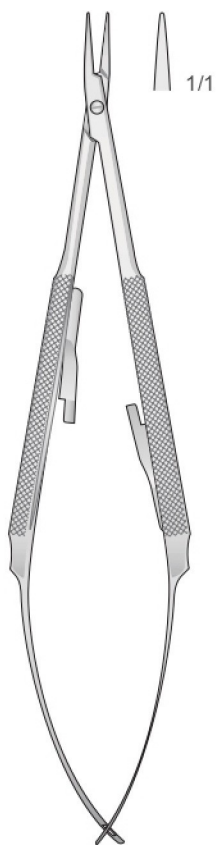

BARRAQUER
DI-FD-216
150 mm

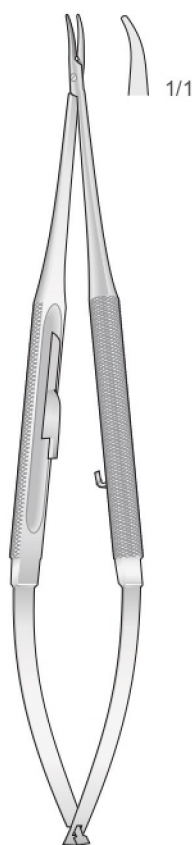

BARRAQUER
DI-FD-217
150 mm

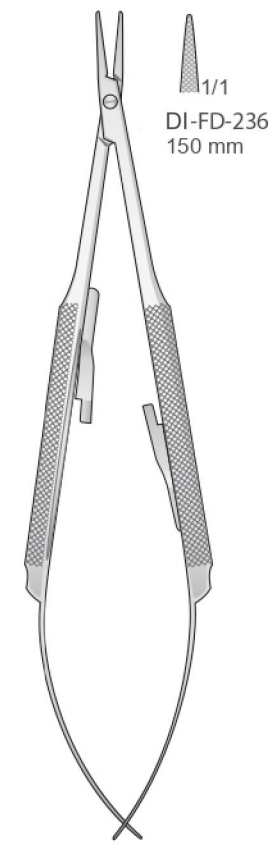

BARRAQUER
DI-FD-236/
DI-FD-237
150 mm

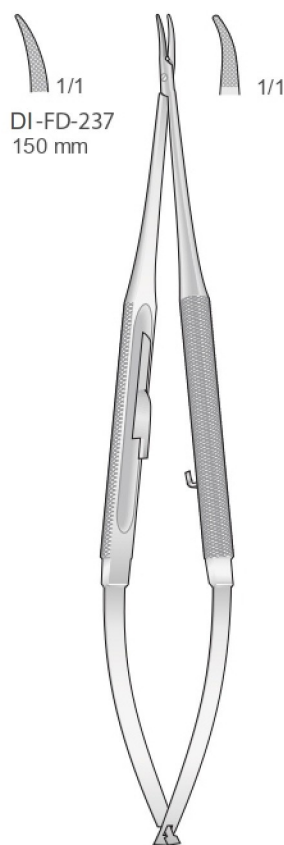

BARRAQUER
DI-FD-24
150 mm



Nadelhalter
Needle Holders
Port'aghi
Portaagujas
Porte aiguilles

Tungsten-Carbide Inserts
Mit Hartmetalleinsätzen
Plaquettes en carbure de tungstène
Plaquetas de carburo de tungsteno
Inserti in carburo di tungsteno

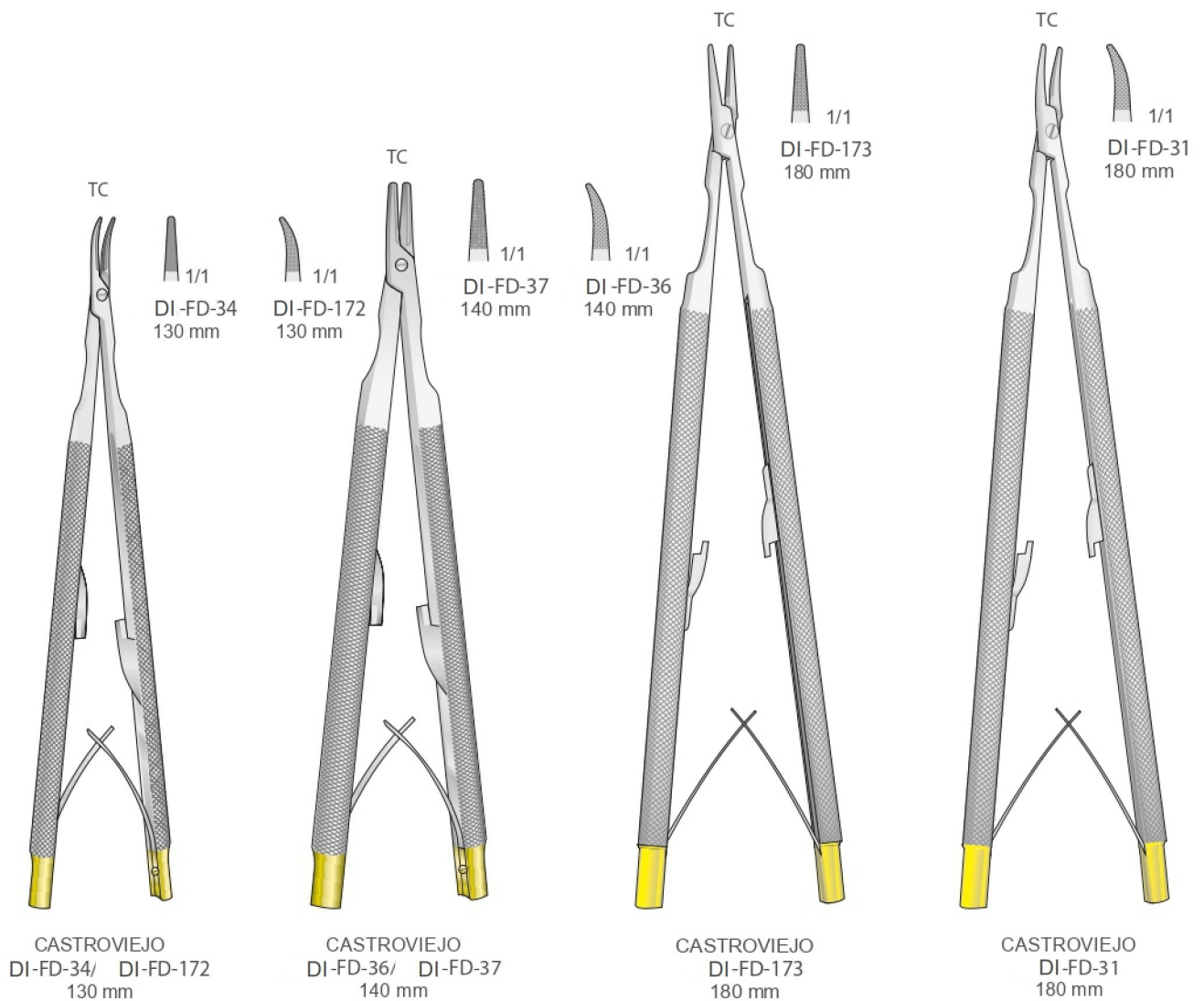



Nadelhalter
Needle Holders
Port'aghi
Portaagujas
Porte aiguilles

Tungsten-Carbide Inserts
Mit Hartmetalleinsätzen
Plaquettes en carbure de tungstène
Plaquetas de carburo de tungsteno
Inserti in carburo di tungsteno

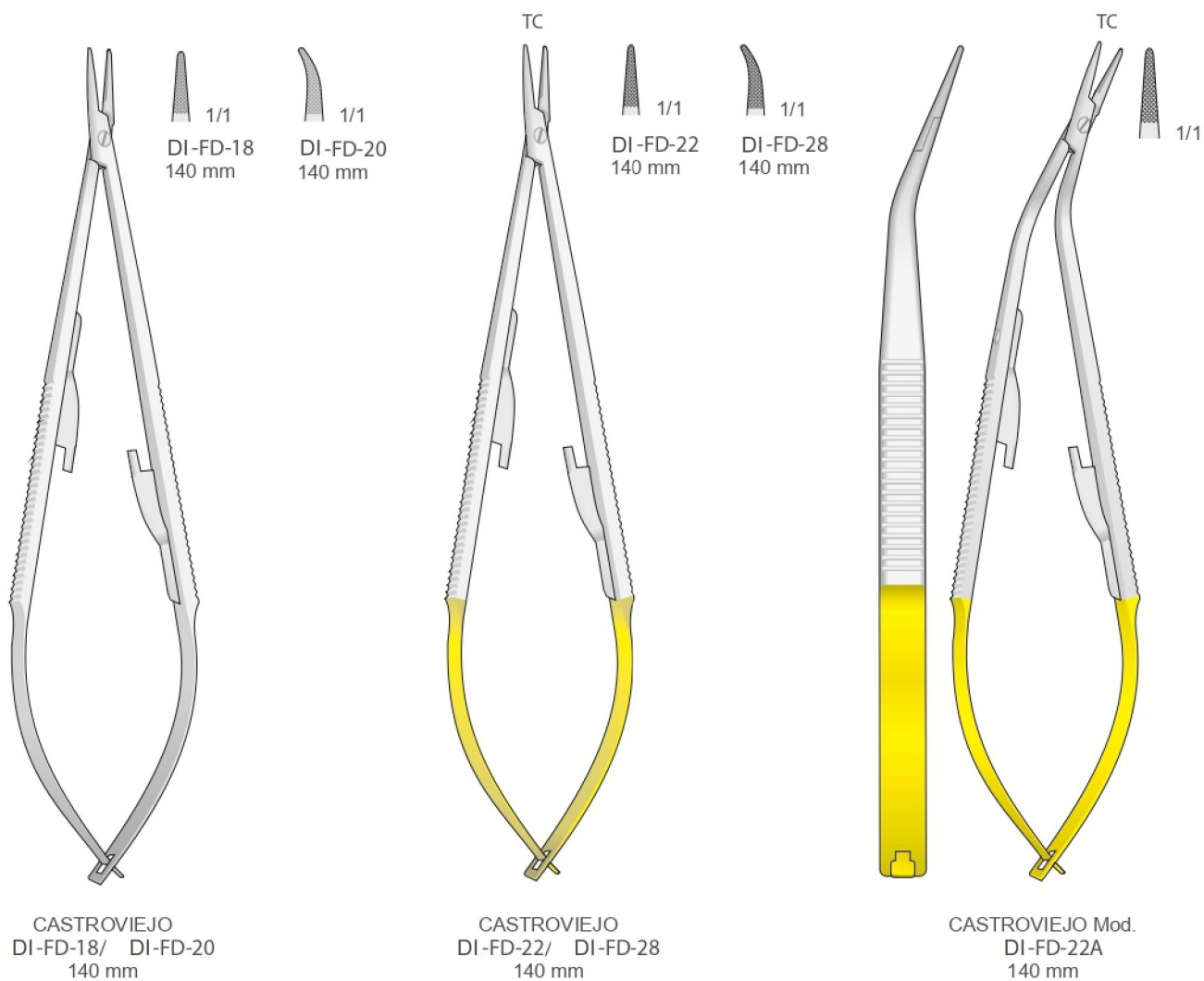



Nadelhalter
Needle Holders
Port'aghi
Portaagujas
Porte aiguilles

Tungsten-Carbide Inserts
Mit Hartmetalleinsätzen
Plaquettes en carbure de tungstène
Plaquetas de carburo de tungsteno
Inserti in carburo di tungsteno

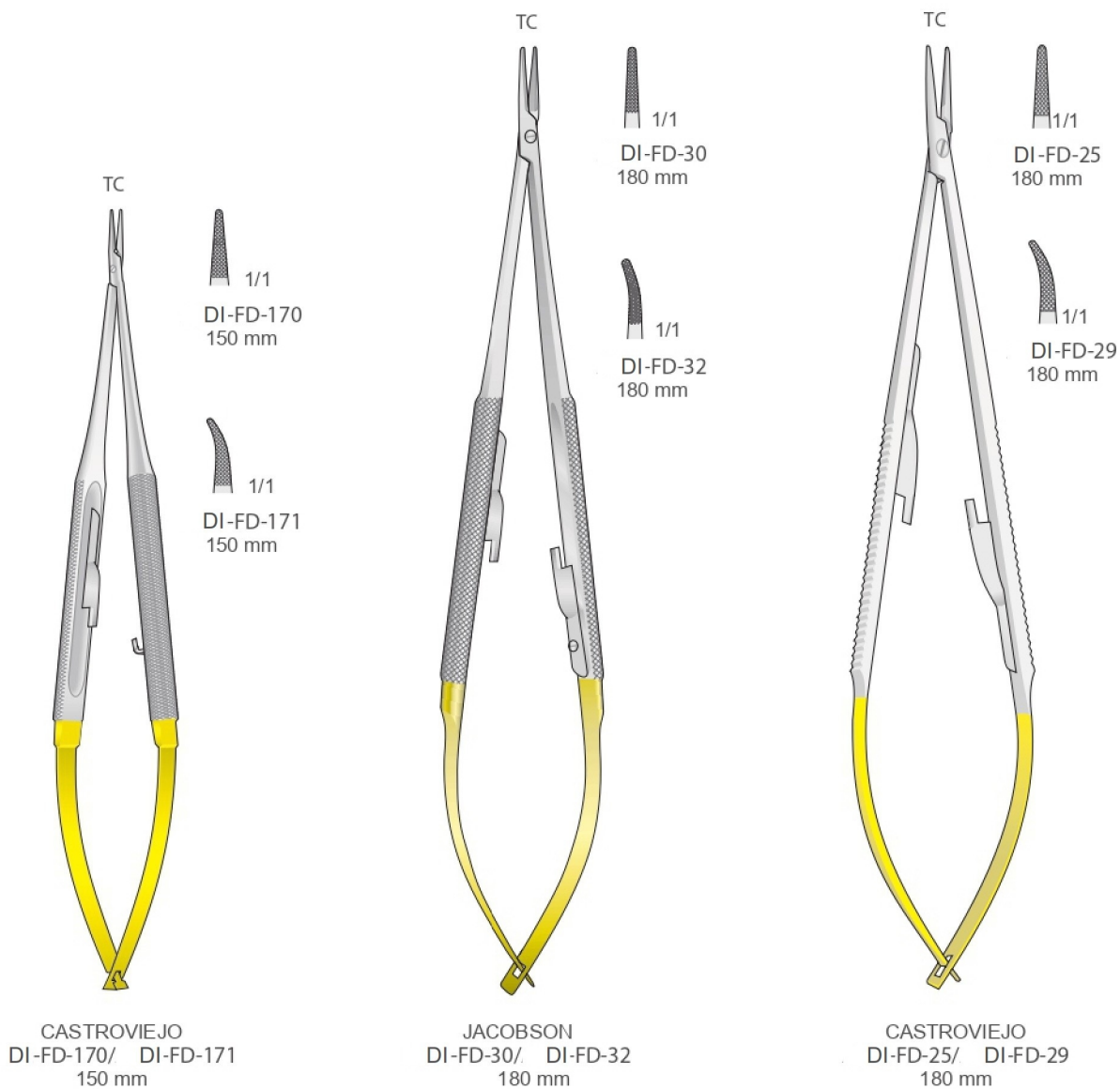



Nadelhalter
Needle Holders
Port'aghi
Portaagujas
Porte aiguilles

Tungsten-Carbide Inserts
Mit Hartmetalleinsätzen
Plaquettes en carbure de tungstène
Plaquetas de carburo de tungsteno
Inserti in carburo di tungsteno

Glattes Maul
Smooth jaws
Con morso liscio
Mandibula lisa
A' mors lisse

TC

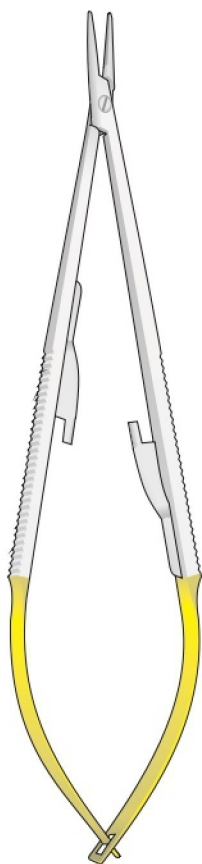

1/1
DI-FD-21
140 mm

1/1
DI-FD-23
140 mm

CASTROVIEJO
DI-FD-21/A DI-FD-23
140 mm

1/1
DI-FD-599

1/1
DI-FD-600

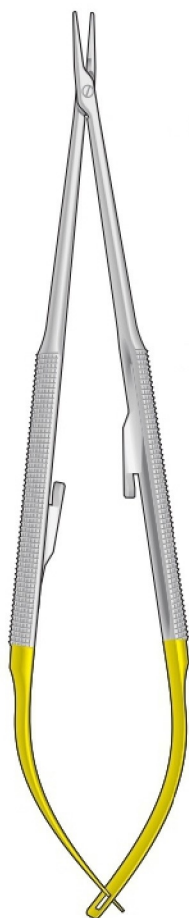

DI-FD-599/ DI-FD-600
150 mm

1/1
DI-FD-601

1/1
DI-FD-602



DI-FD-601/ DI-FD-602
180 mm

Diamond Tip
Diamantiert
Punta diamantata
Punta de diamante
Pointe de diamant



Mikro Nadelhalter - Mikro Scheren
Micro Needle Holders - Micro Scissors
Micro Port'aghi - Micro Forbici
Micro Portaagujas - Micro Tijeras
Micro Porte aiguilles - Micro Ciseaux

Titanium
Titan
Titane
Titanio
Titanio

Rund-Griffe Ø 8 mm
Round handle Ø 8 mm
Manico rotondo Ø 8 mm
Mango redondo Ø 8 mm
Manche rond Ø 8 mm

Mikro Nadelhalter
Micro Needle Holders
Micro port'aghi
Micro portaagujas
Micro porte aiguilles

Mikro Scheren
Micro Scissors
Micro forbici
Micro tijeras
Micro ciseaux

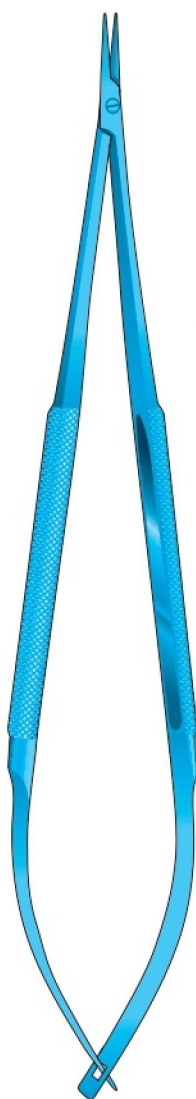

1/1
DI-FD-562T



1/1
DI-FD-563T

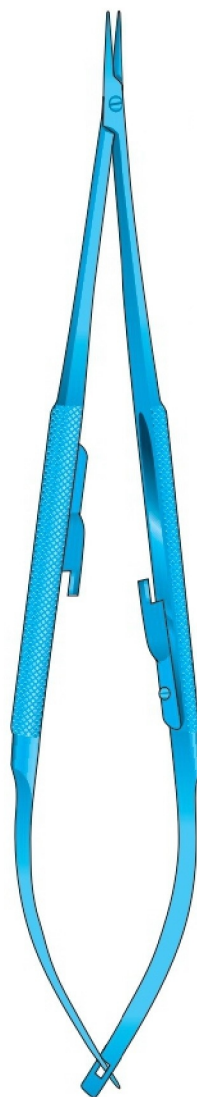

1/1
DI-FD-574T



1/1
DI-FD-575T

Mit Sperre
With Lock
Con arresto
Con cierre
Avec Arrêt

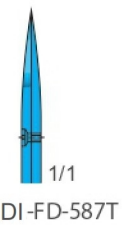

1/1
DI-FD-587T

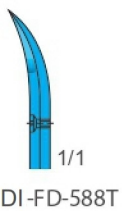

1/1
DI-FD-588T

DI-FD-562T/ DI-FD-563T
180 mm

DI-FD-574T/ DI-FD-575T
180 mm

DI-FD-587T/ DI-FD-588T
180 mm



Nadelhalter
Needle Holders
Port'aghi
Portaagujas
Porte aiguilles

Tungsten-Carbide Inserts
Mit Hartmetalleinsätzen
Plaquettes en carbure de tungstène
Plaquetas de carburo de tungsteno
Inserti in carburo di tungsteno

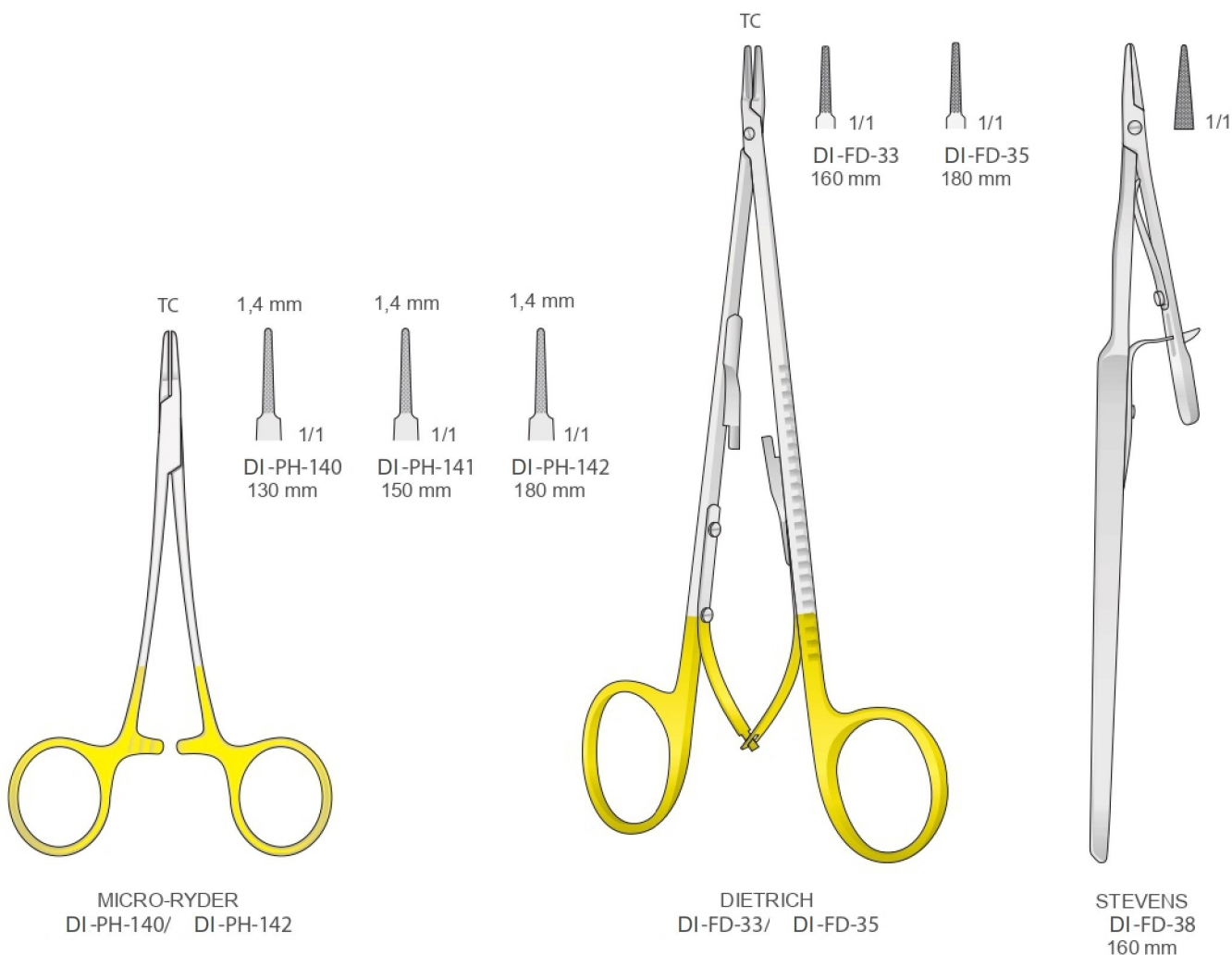



Nadelhalter
Needle Holders
Port'aghi
Portaagujas
Porte aiguilles

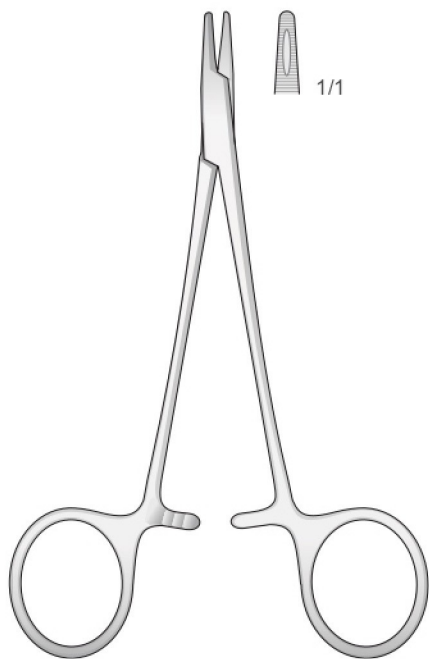

DERF
DI-PH-39
125 mm



1/1

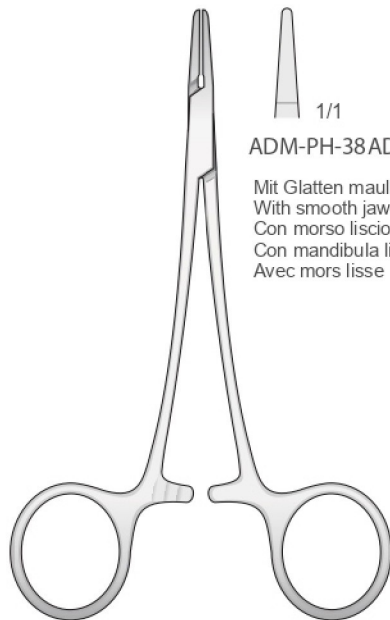

DI-PH-38/ DI-PH-64
120 mm

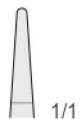

1/1



1/1

ADM-PH-38 ADM-PH-64

Mit Glatten maul
With smooth jaws
Con morso liscio
Con mandibula lisa
Avec mors lisse

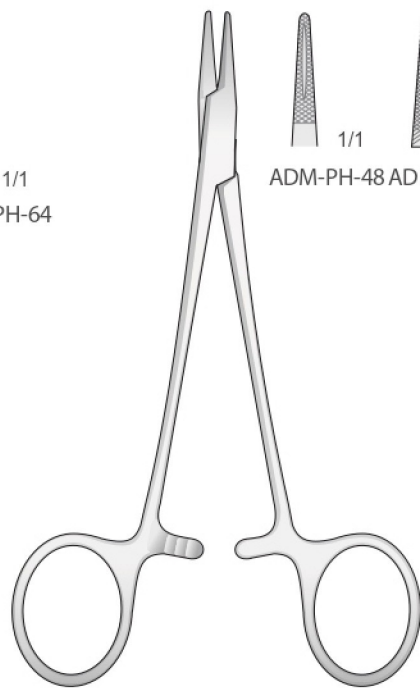

HALSEY
DI-PH-48/ DI-PH-63
130 mm



1/1

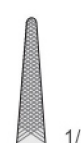

1/1

ADM-PH-48 ADM-PH-63

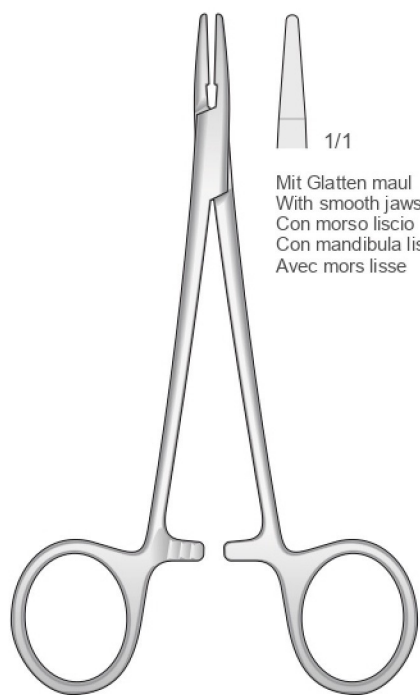

HALSEY
DI-PH-37
130 mm

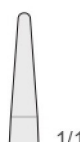

1/1

Mit Glatten maul
With smooth jaws
Con morso liscio
Con mandibula lisa
Avec mors lisse

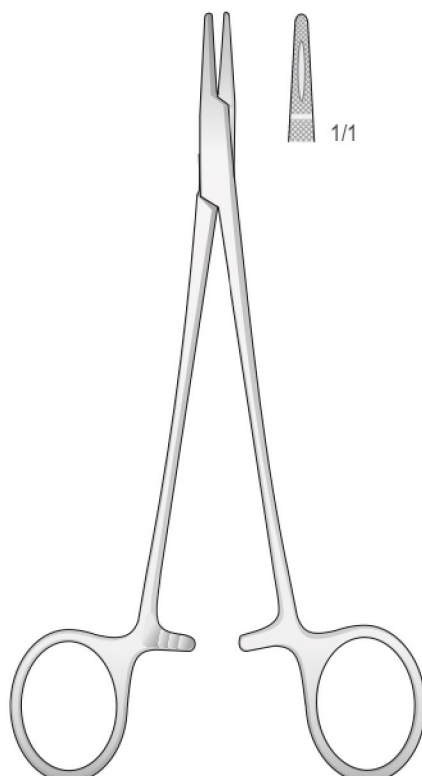

CRILE-WOOD
DI-PH-61
150 mm

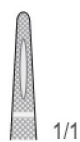

1/1

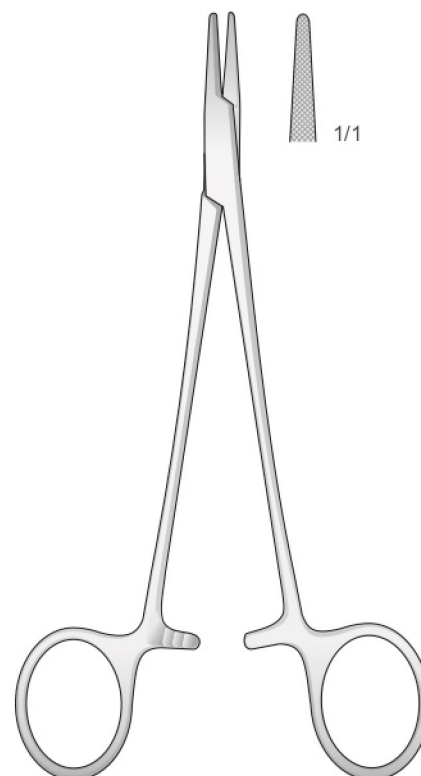

CRILE-MURRAY
DI-PH-62
150 mm

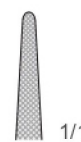

1/1



Nadelhalter mit Schere - Needle holders with scissors
Port'aghi con forbici - Portaagujas con tijeras
Porte aiguilles avec ciseaux

Nadelhalter
Needle Holders
Port'aghi
Portaagujas
Porte aiguilles

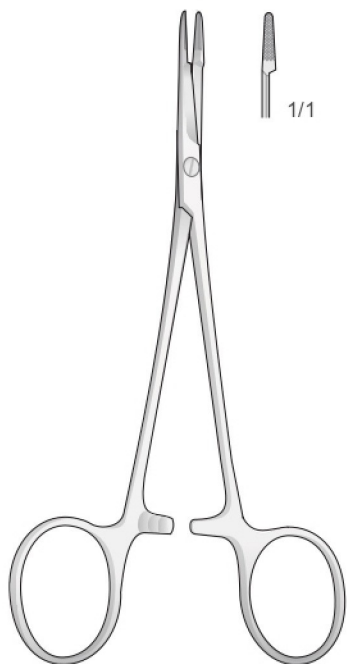

MINI-OLSEN-HEGAR
DI-BM-61
120 mm

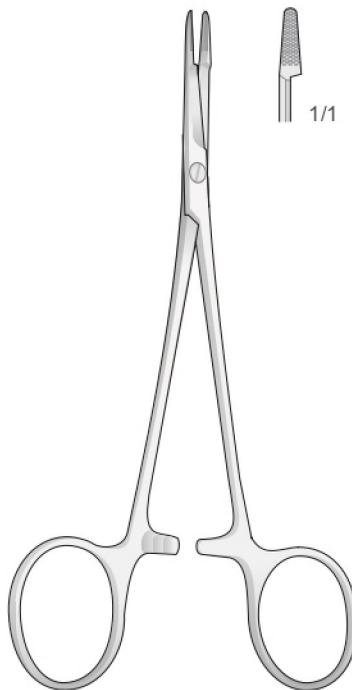

OLSEN-HEGAR
DI-BM-62
140 mm

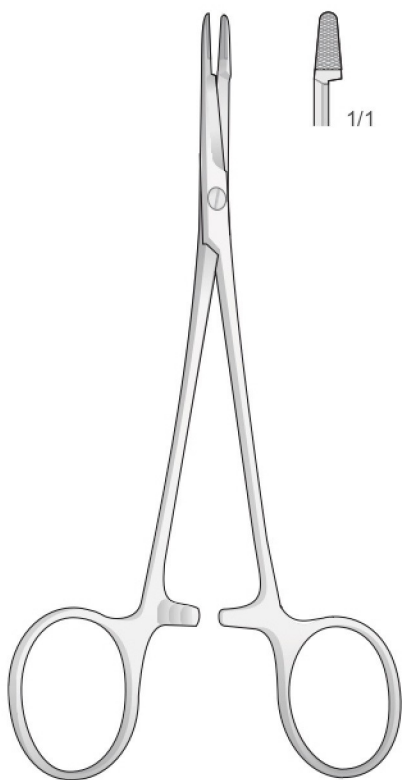

OLSEN-HEGAR
DI-BM-63
170 mm

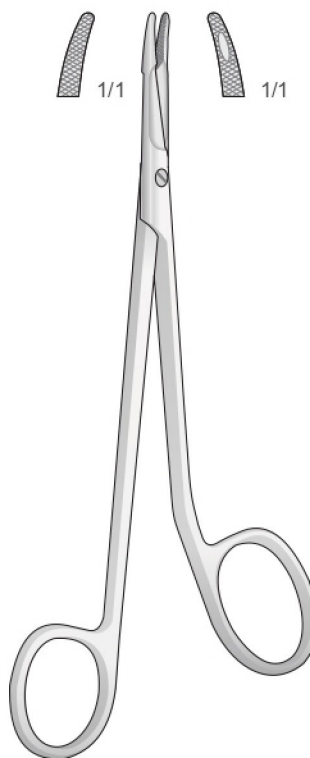

MINI-GILLIES
DI-PO-59
145 mm



Nadelhalter
Needle Holders
Port'aghi
Portaagujas
Porte aiguilles

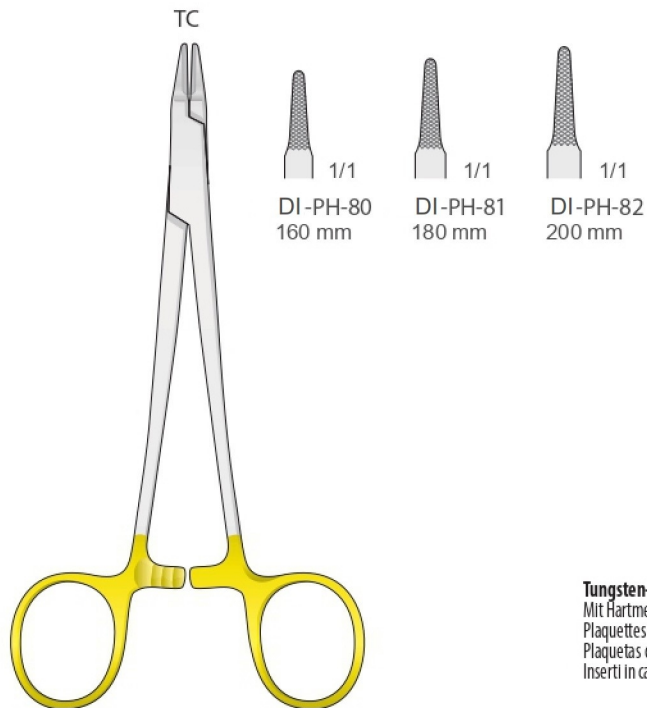

RYDER
DI-PH-80/ADM-PH-82

Tungsten-Carbide Inserts
Mit Hartmetalleinsätzen
Plaquettes en carbure de tungstène
Plaquetas de carburo de tungsteno
Inserti in carburo di tungsteno

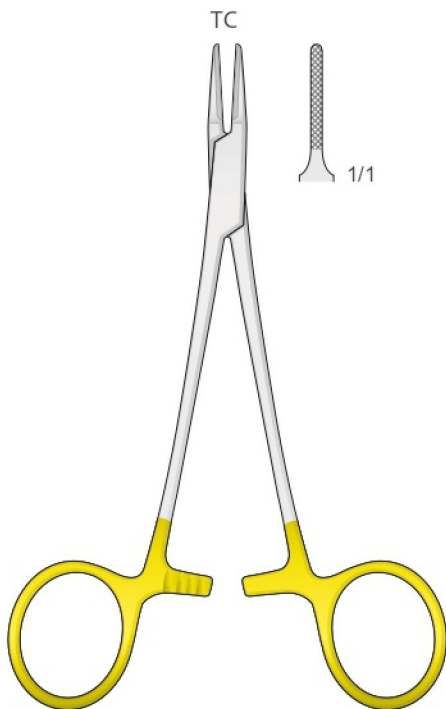

RYDER
DI-PH-83
140 mm

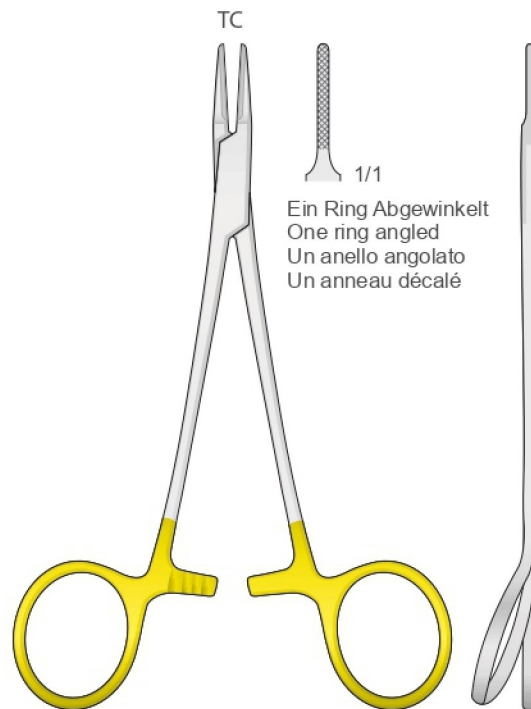

DI-PH-84
140 mm

Ein Ring Abgewinkelt
One ring angled
Un anello angolato
Un anneau décalé



Nadelhalter
Needle Holders
Port'aghi
Portaagujas
Porte aiguilles

Tungsten-Carbide Inserts
Mit Hartmetalleinsätzen
Plaquettes en carbure de tungstène
Plaquetas de carburo de tungsteno
Inserti in carburo di tungsteno

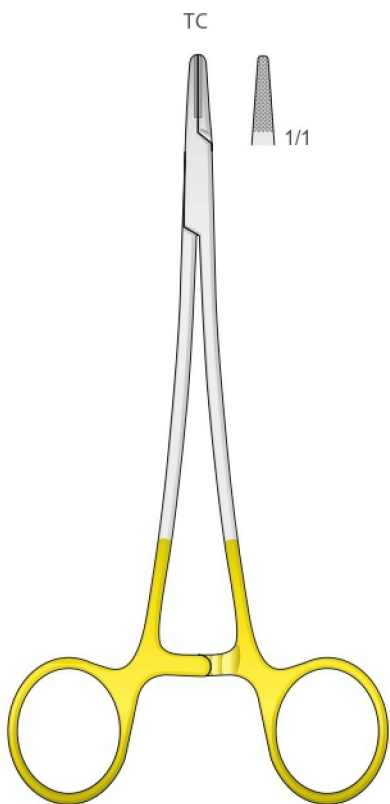

DI-PH-79
145 mm

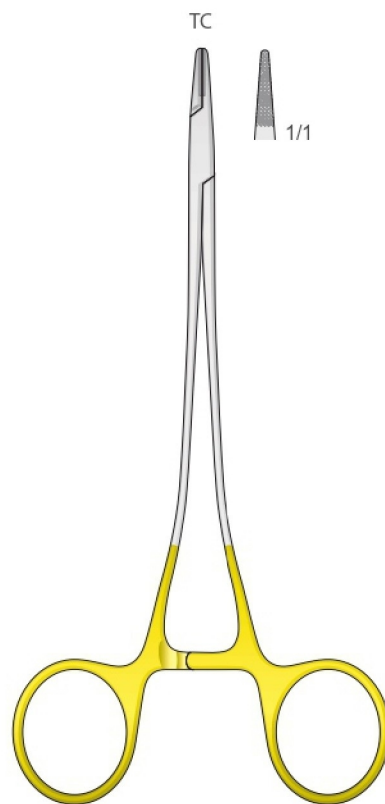

FINE SWEDISH PATTERN
DI-PH-85
150 mm

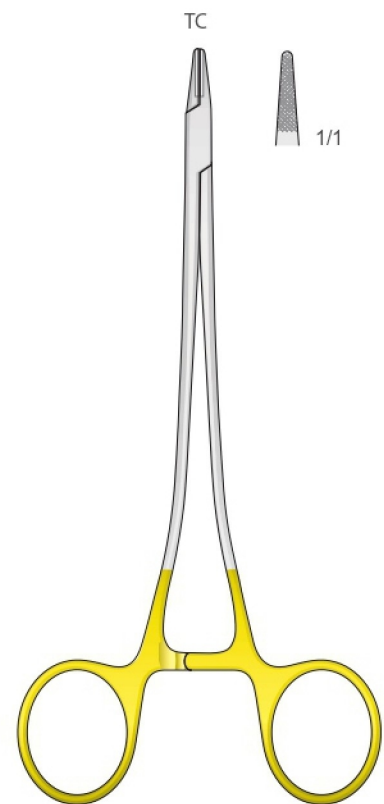

SWEDISH MOD.
DI-PH-106
150 mm



Nadelhalter
Needle Holders
Port'aghi
Portaagujas
Porte aiguilles

Tungsten-Carbide Inserts
Mit Hartmetalleinsätzen
Plaquettes en carbure de tungstène
Plaquetas de carburo de tungsteno
Inserti in carburo di tungsteno

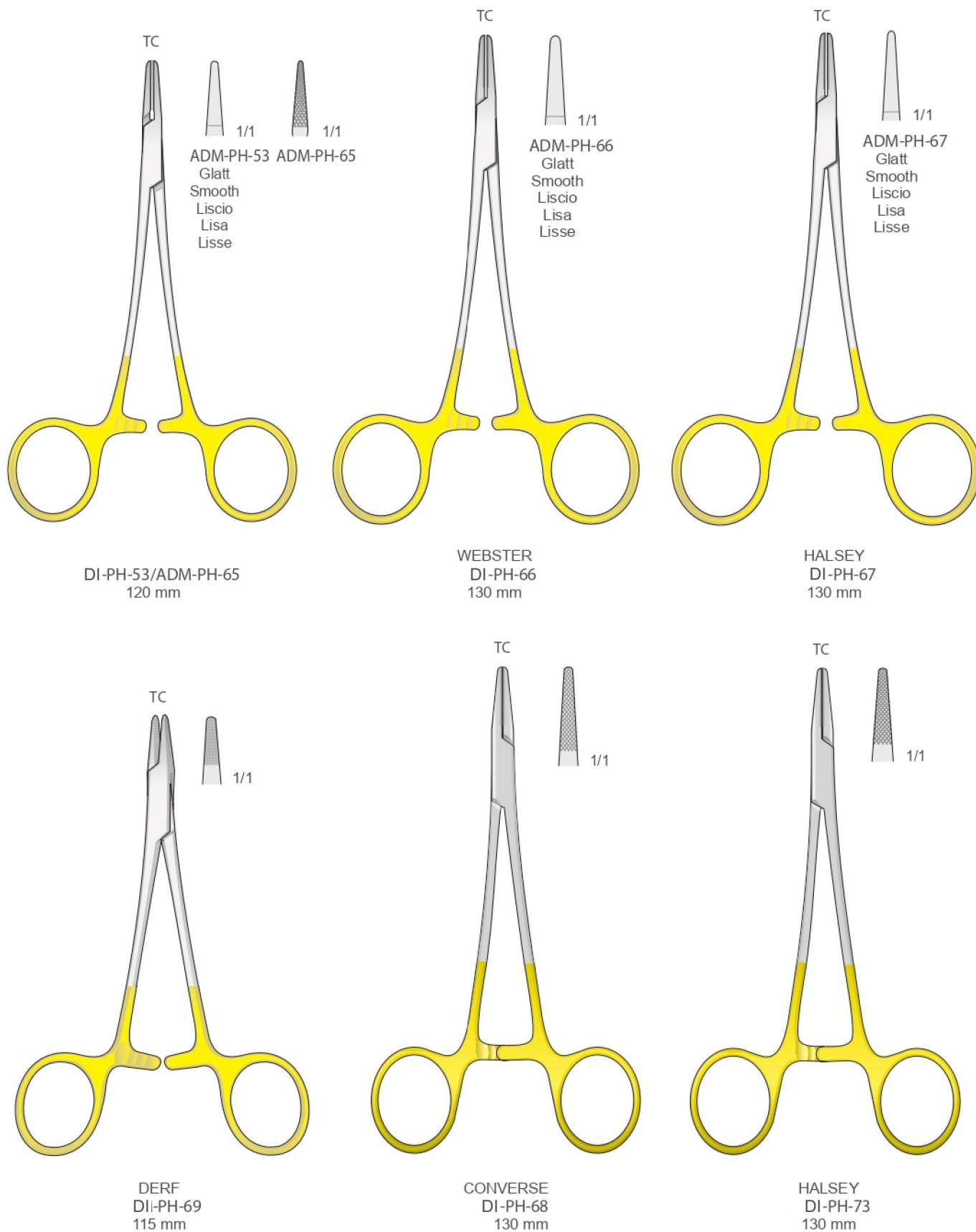



Tungsten-Carbide Inserts
Mit Hartmetalleinsätzen
Plaquettes en carbure de tungstène
Plaquetas de carburo de tungsteno
Inserti in carburo di tungsteno

Nadelhalter
Needle Holders
Port'aghi
Portaagujas
Porte aiguilles

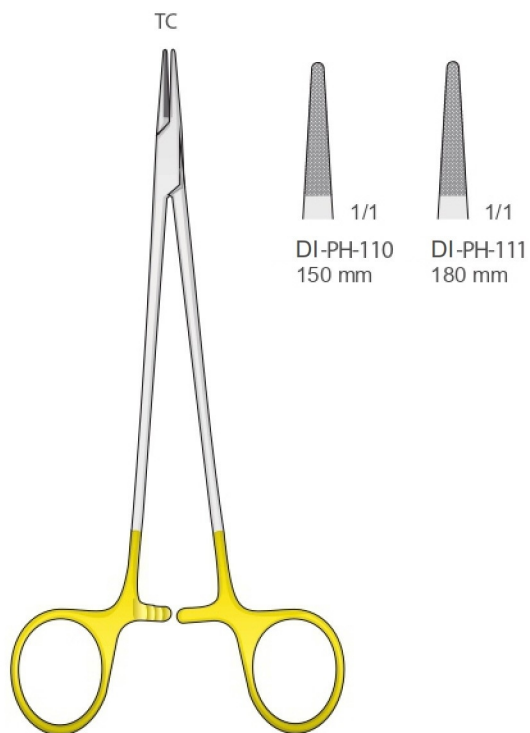

DE BAKEY
DI-PH-110/ DI-PH-111

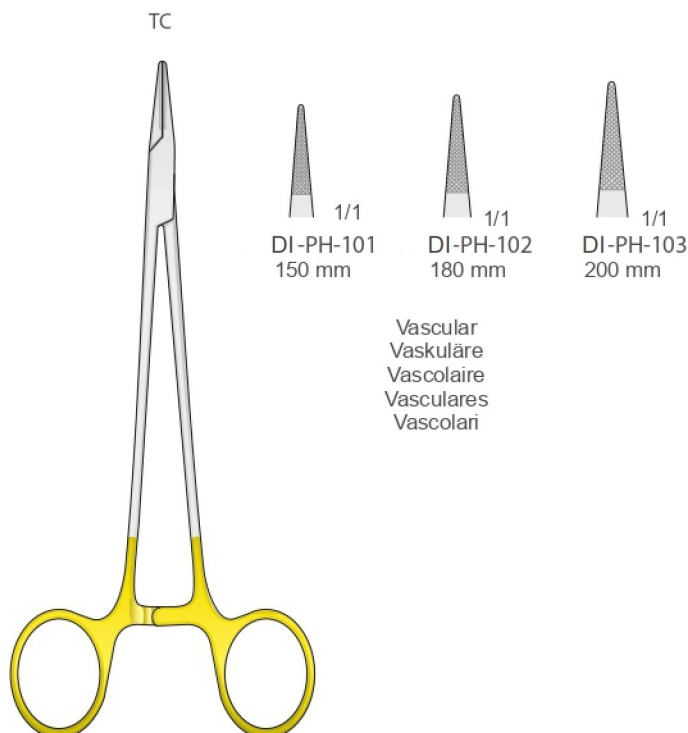

MICRO-VASCULAR
DI-PH-101/ DI-PH-102/ DI-PH-103

Vascular
Vaskuläre
Vasculaire
Vasculares
Vascolari

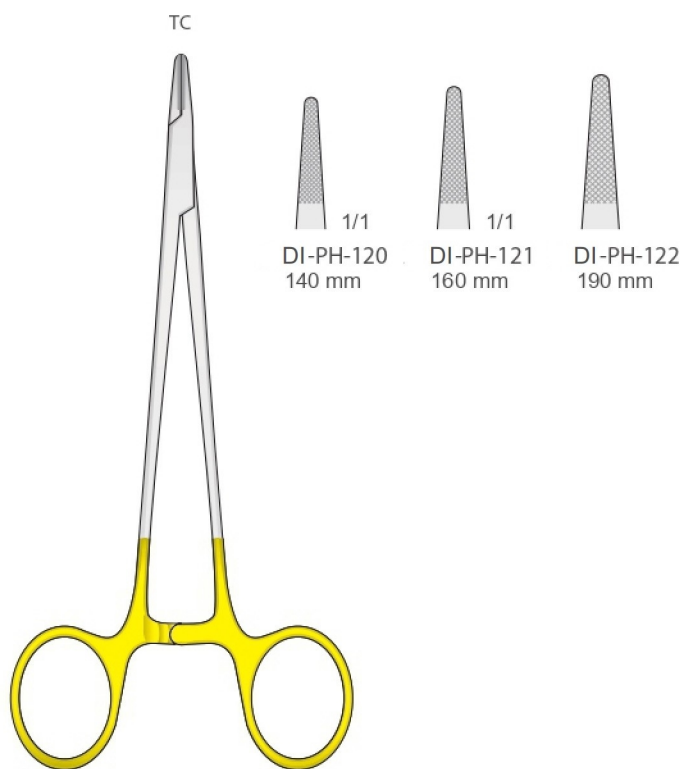

MAYO-HEGAR
DI-PH-120/ DI-PH-121/ DI-PH-122

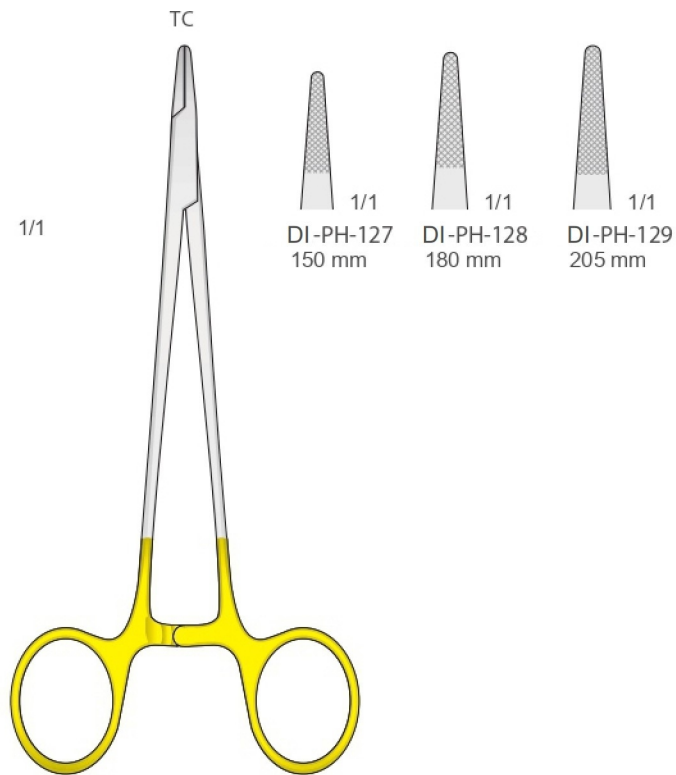

MAYO-HEGAR-FINO
DI-PH-127/ DI-PH-128/ DI-PH-129



Nadelhalter
Needle Holders
Port'aghi
Portaagujas
Porte aiguilles

Tungsten-Carbide Inserts
Mit Hartmetalleinsätzen
Plaquettes en carbure de tungstène
Plaquetas de carburo de tungsteno
Inserti in carburo di tungsteno

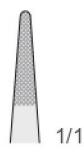
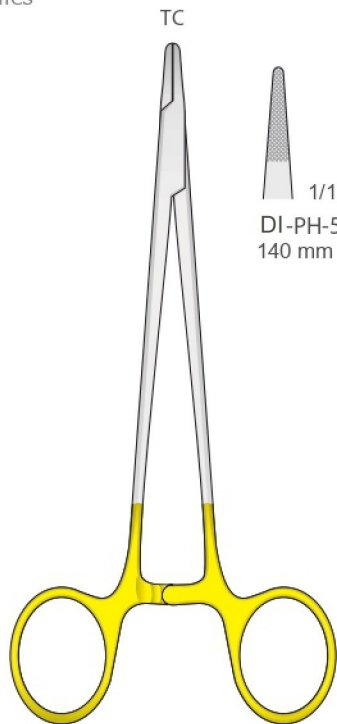

DI-PH-59
140 mm



DI-PH-72
160 mm



DI-PH-75
180 mm

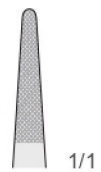

DI-PH-76
200 mm

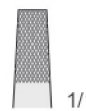
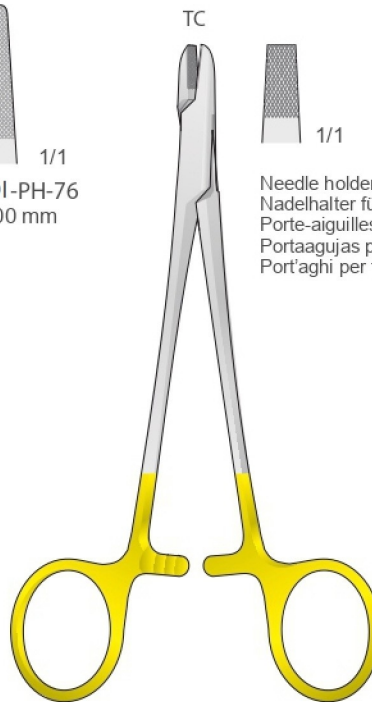

Needle holders for wire
Nadelhalter für drähte
Porte-aiguilles pour fil métallique
Portaagujas para hilo metálico
Port'aghi per fili metallici

HEGAR
DI-PH-59/ DI-PH-72/ DI-PH-75/ DI-PH-76

DI-PH-58
150 mm

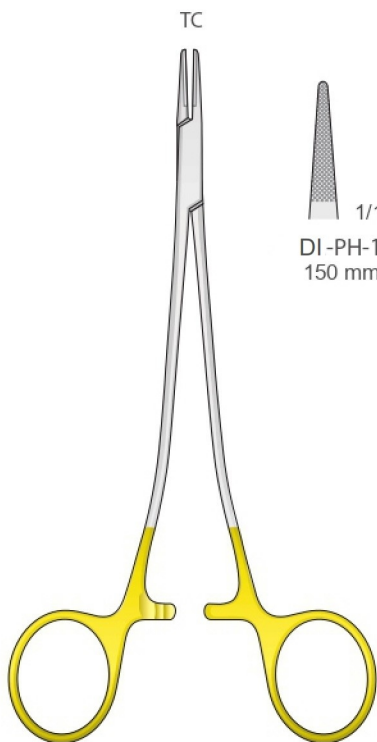

DI-PH-132
150 mm

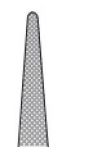

DI-PH-133
180 mm

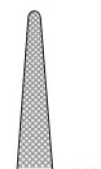

DI-PH-134
210 mm

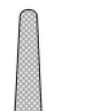
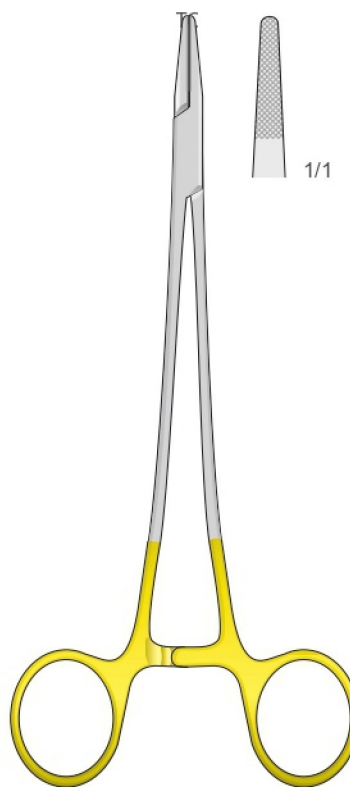

SAROT
DI-PH-132/ DI-PH-133/ DI-PH-134

CRILE-WOOD
DI-PH-77
180 mm



Tungsten-Carbide Inserts
Mit Hartmetalleinsätzen
Plaquettes en carbure de tungstène
Plaquetas de carburo de tungsteno
Inserti in carburo di tungsteno

Nadelhalter
Needle Holders
Port'aghi
Portaagujas
Porte agujas

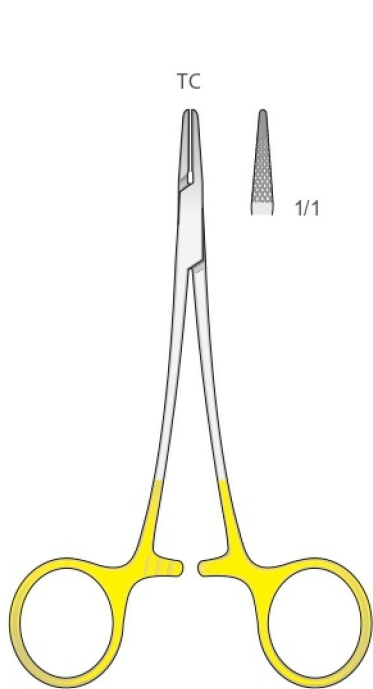

DI-PH-99
120 mm

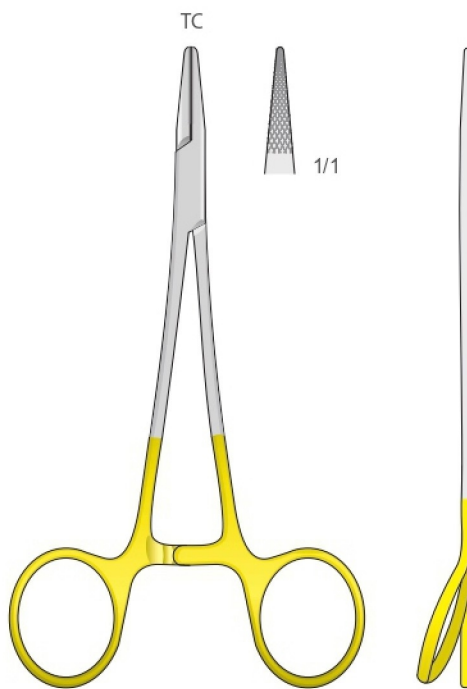

CRILE-WOOD
DI-PH-100
150 mm

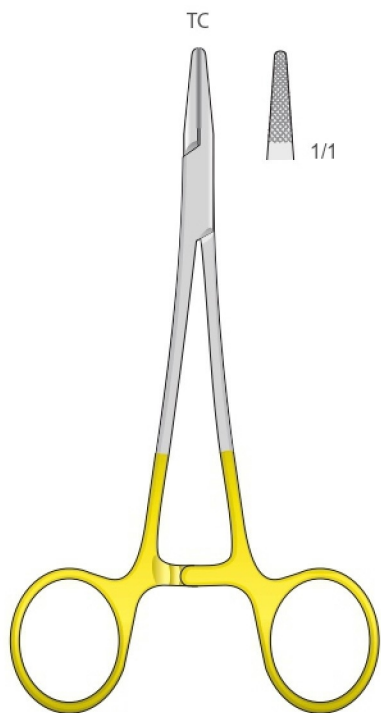

BABY-CRILE-WOOD
DI-PH-54
150 mm

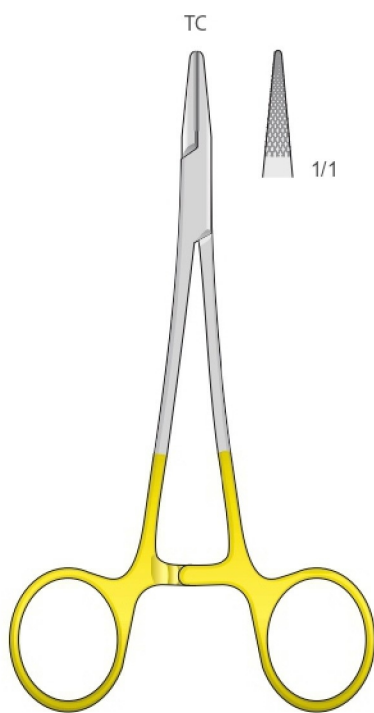

CRILE-WOOD
DI-PH-71
150 mm



CRILE-WOOD
DI-PH-90
150 mm



Nadelhalter
Needle Holders
Port'aghi
Portaagujas
Porte aiguilles

Tungsten-Carbide Inserts
Mit Hartmetalleinsätzen
Plaquettes en carbure de tungstène
Plaquetas de carburo de tungsteno
Inserti in carburo di tungsteno

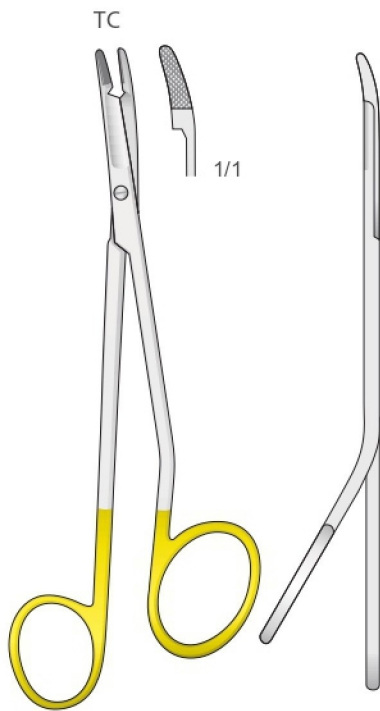

MINI-GILLIES
DI-PO-99
145 mm

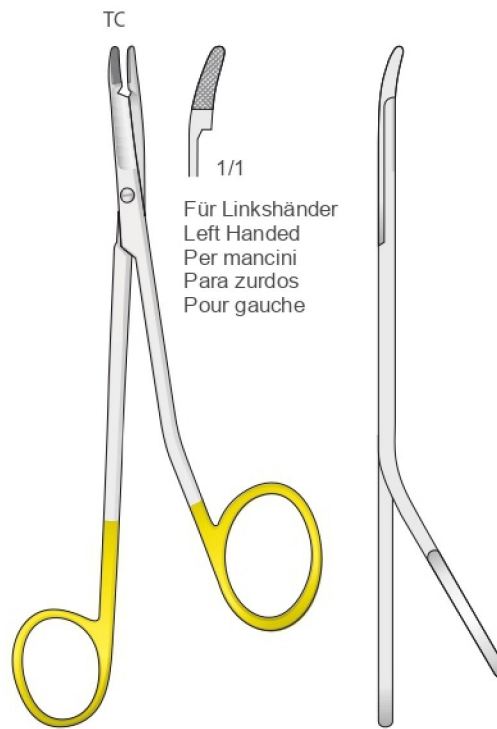

MINI-GILLIES
DI-PO-99L
145 mm

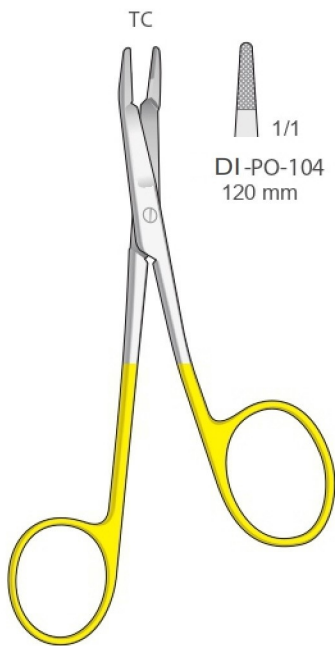

FOSTER-GILLIES
DI-PO-104/ DI-PO-105
120 mm

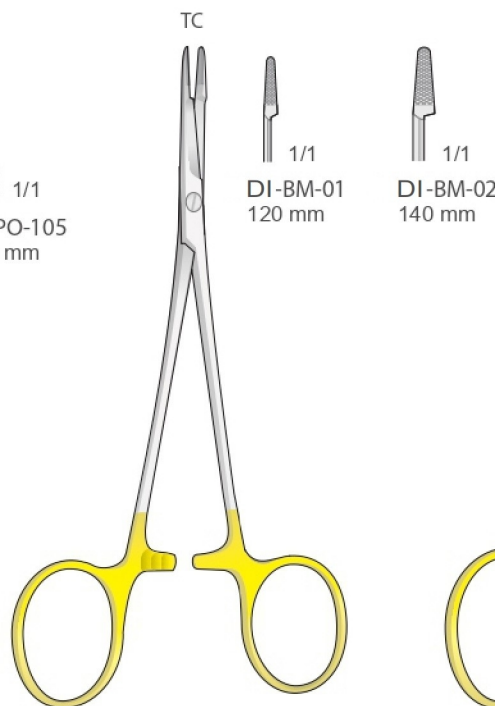

OLSEN-HEGAR
DI-BM-01/ DI-BM-02

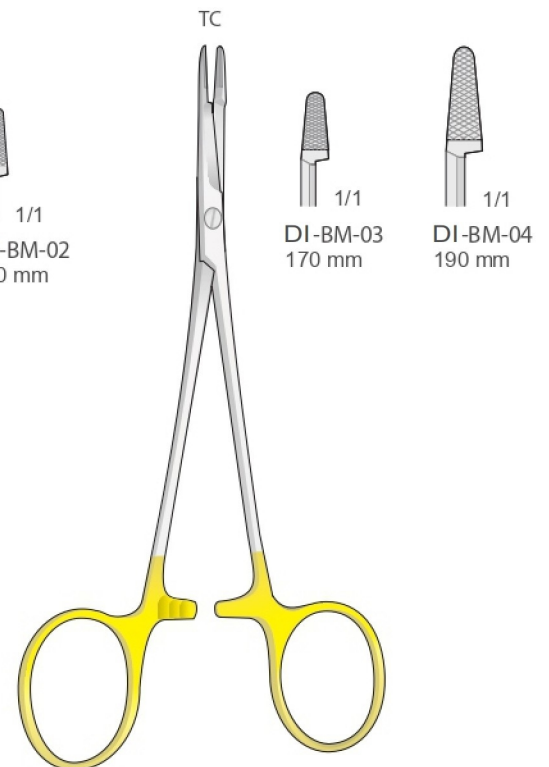

OLSEN-HEGAR
DI-BM-03/ DI-BM-04



Nadelhalter
Needle Holders
Port'aghi
Portaagujas
Porte aiguilles

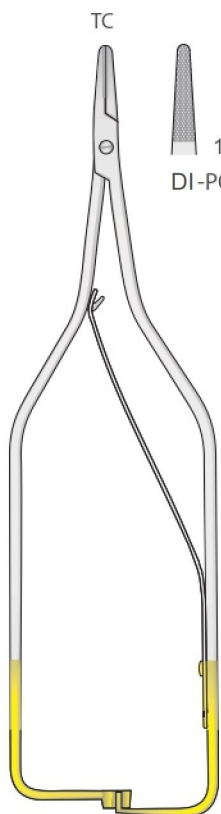

ARRUGA
DI-PO-85/ DI-PO-87
160 mm

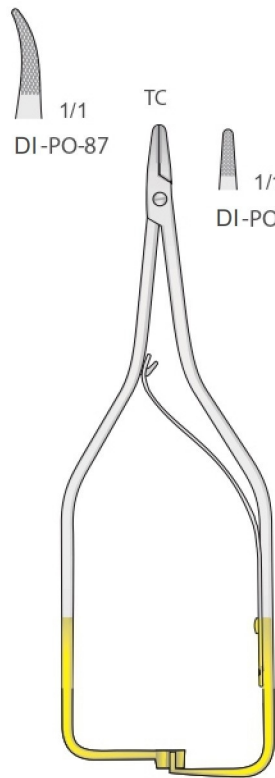

BOYNTON
DI-PO-55/ DI-PO-56
120 mm

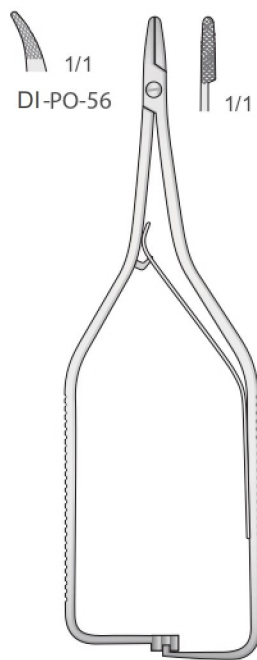

BOYNTON
DI-PO-88
120 mm

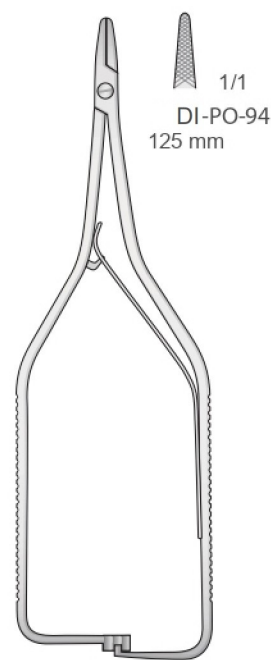

BOYNTON
DI-PO-94
125 mm

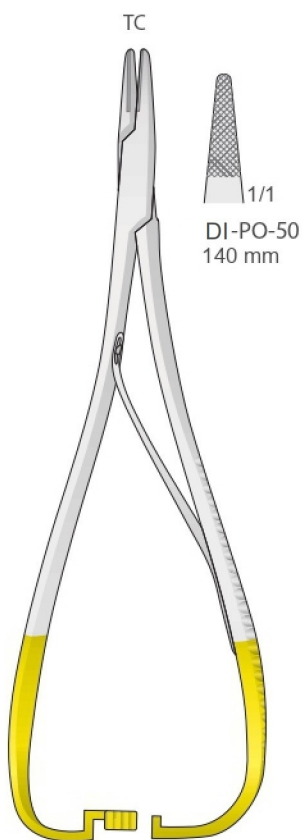

MATHIEU
DI-PO-50/ DI-PO-52

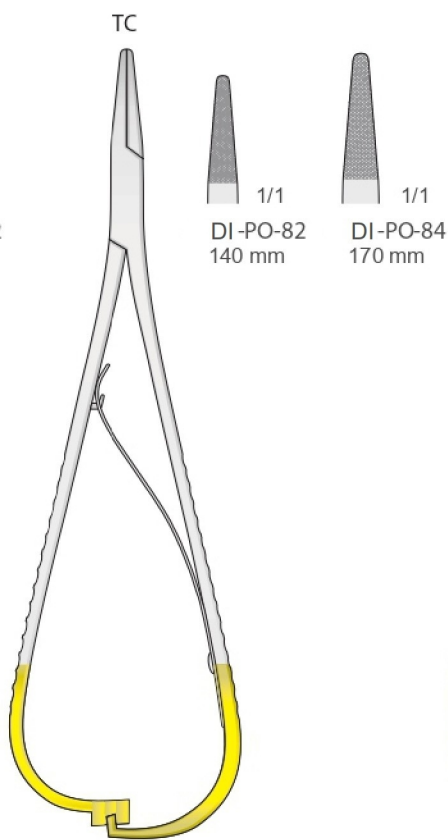

MATHIEU
DI-PO-82/ DI-PO-84

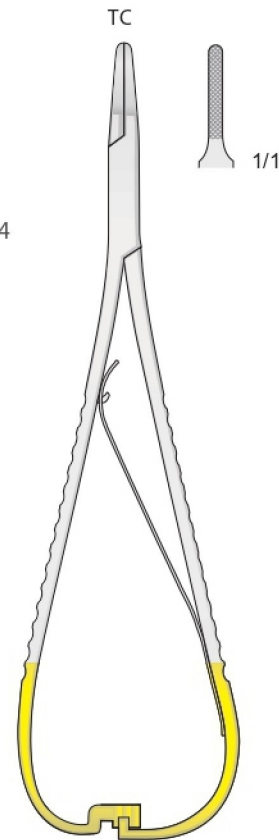

LICHTENBERG
DI-PO-86
175 mm



Nadelhalter
Needle Holders
Port'aghi
Portaagujas
Porte aiguilles

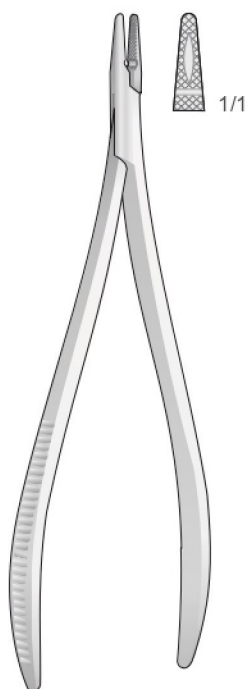

CRILE
DI-PO-37
150 mm

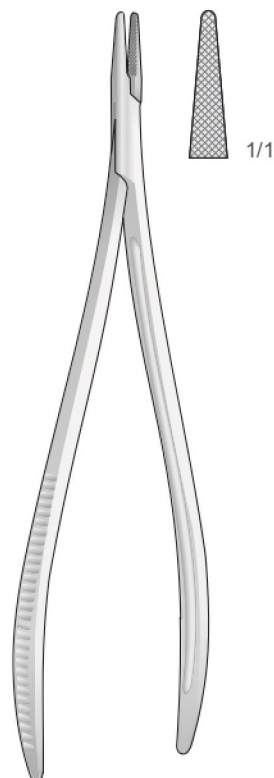

TÖNNIS
DI-PO-38
190 mm

Schlankesmodell - Delicate pattern - Modello fine
Modelo delegado - Modèle fin

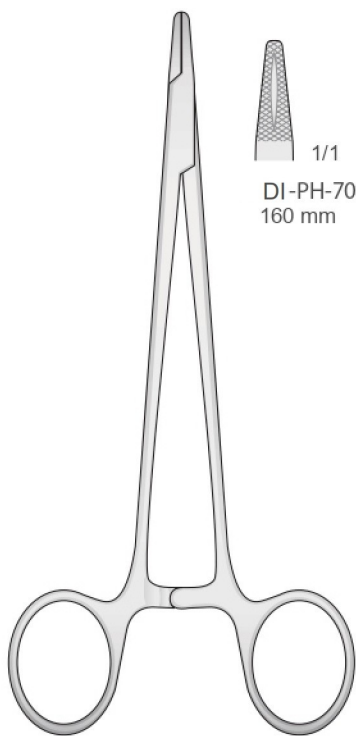

HEGAR
DI-PH-70/ DI-PH-74

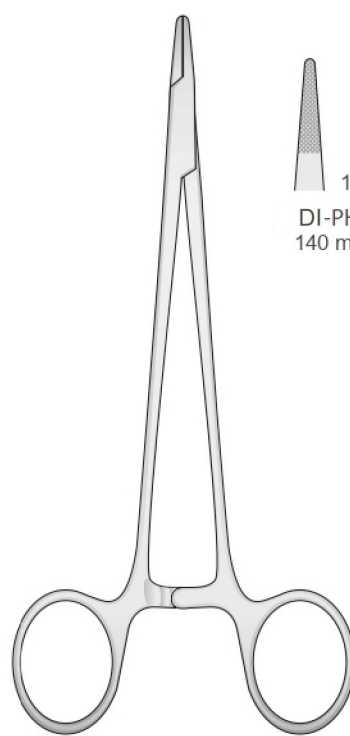
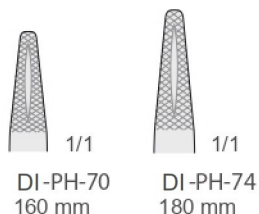

MAYO-HEGAR
DI-PH-40/ DI-PH-42

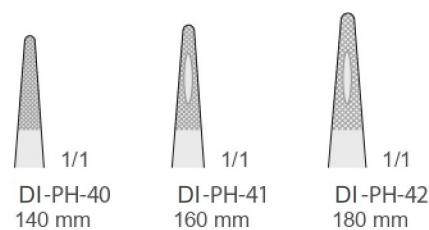



Nadelhalter
Needle Holders
Port'aghi
Portaagujas
Porte aiguilles

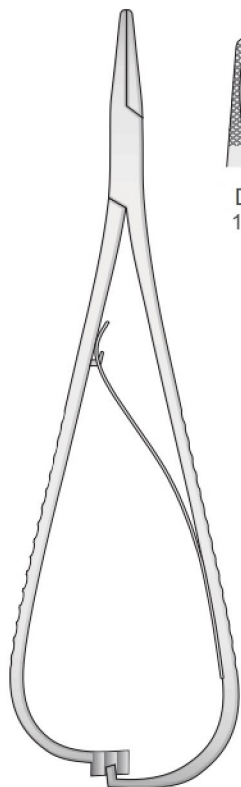

MATHIEU
DI-PO-65/ DI-PO-81

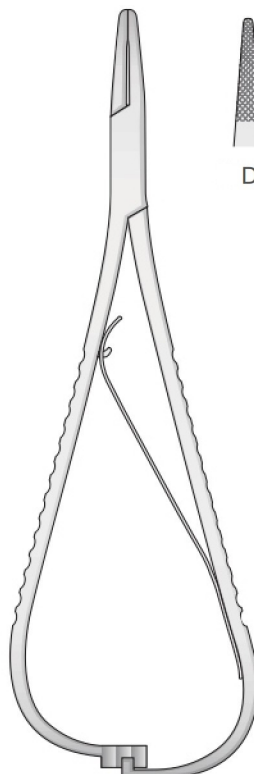
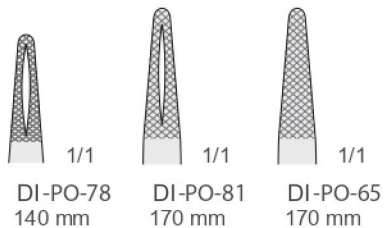

MATHIEU
DI-PO-79/ DI-PO-80
140 mm

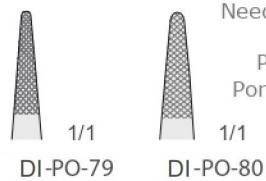

MATHIEU
DI-PO-46/ DI-PO-48

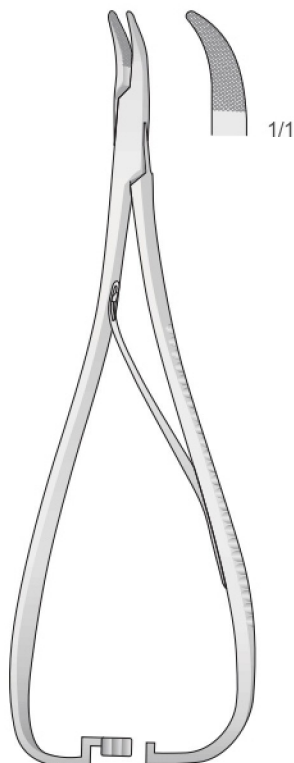
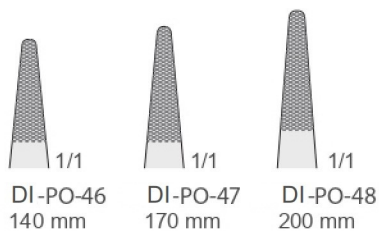

DI-PO-40
140 mm

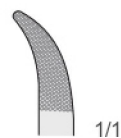



Nadelhalter
Needle Holders
Port'aghi
Portaagujas
Porte aiguilles

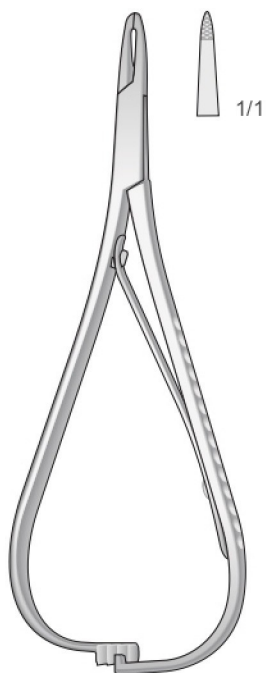

MATHIEU
DI-PO-45
125 mm

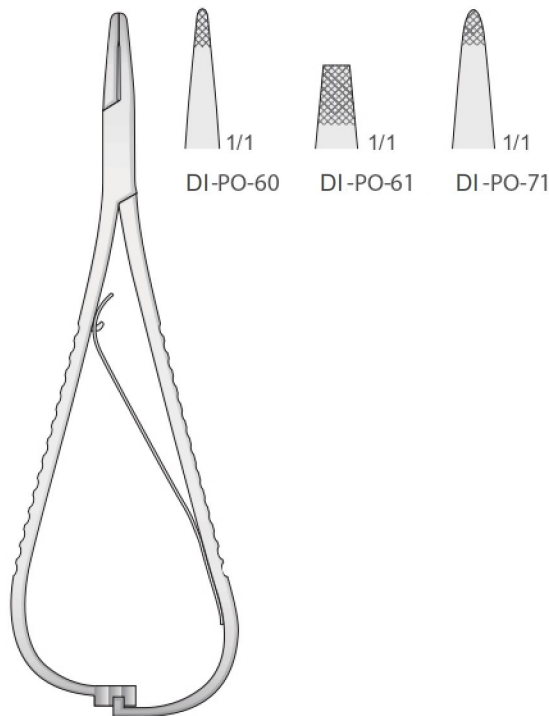

MATHIEU
DI-PO-60/ DI-PO-71
140 mm

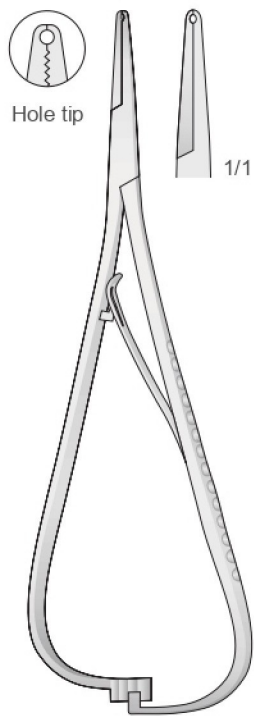

SMAHA
DI-PO-68
140 mm

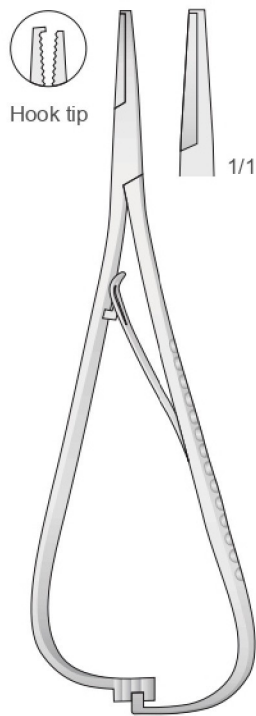

SMAHA
DI-PO-69
140 mm

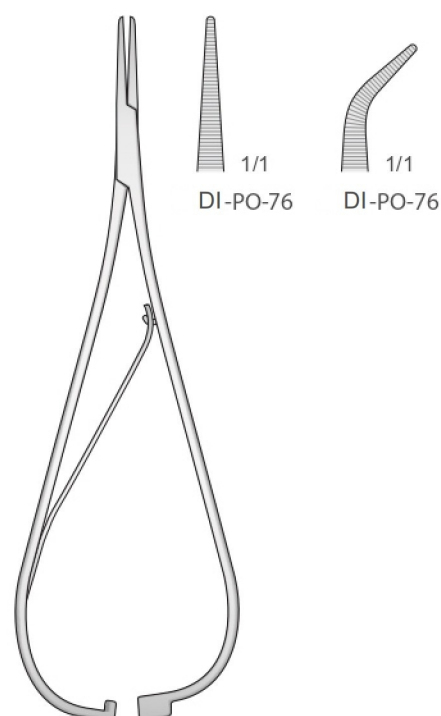

SMAHA
DI-PO-76/ADM-PO-77
140 mm