

Implantology

**DENTAL
INSTRUMENTS
CATALOGUE**



Health Fast Surgical
Surgical Manufacturer Company



Osteotome
Osteotomes
Osteotomi
Osteótomos
Osteótomes

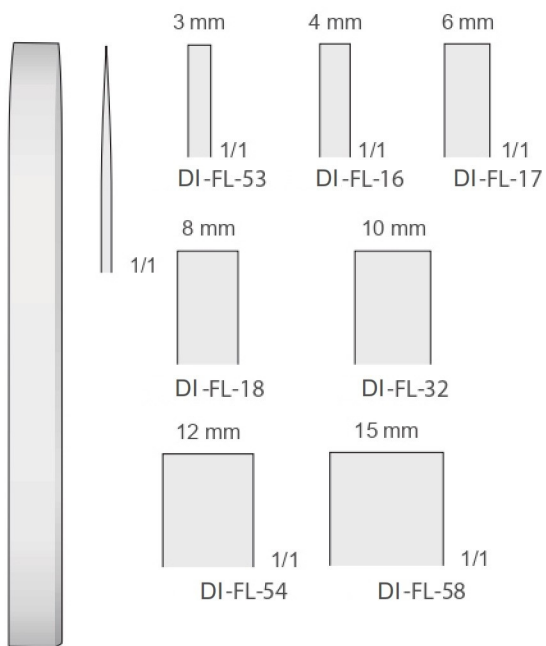

MINI-LAMBOTTE
DI-FL-16/ DI-FL-58
125 mm

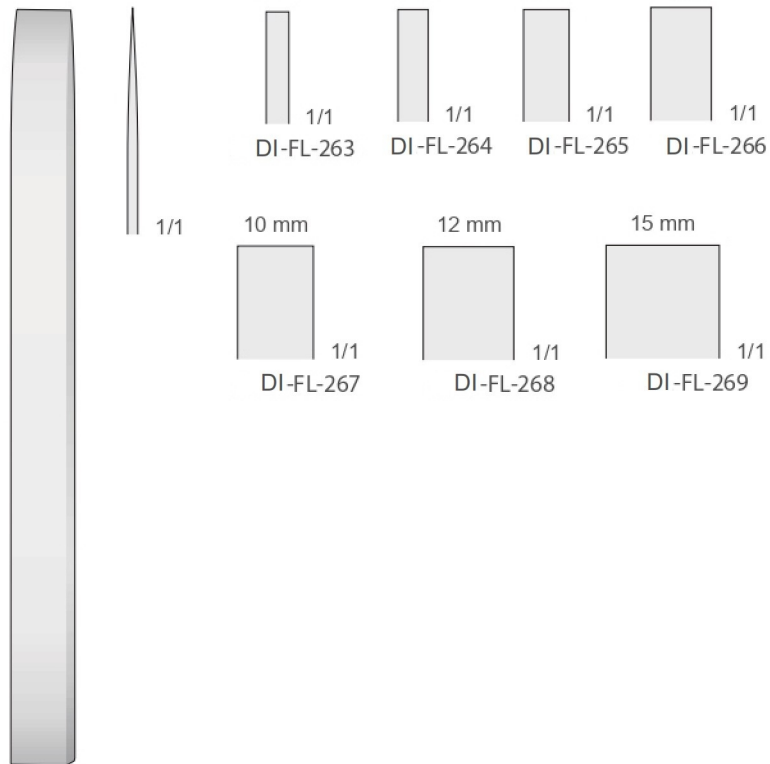

MINI-LAMBOTTE
DI-FL-263/ DI-FL-269
170 mm

Taglio singolo

Taglio doppio

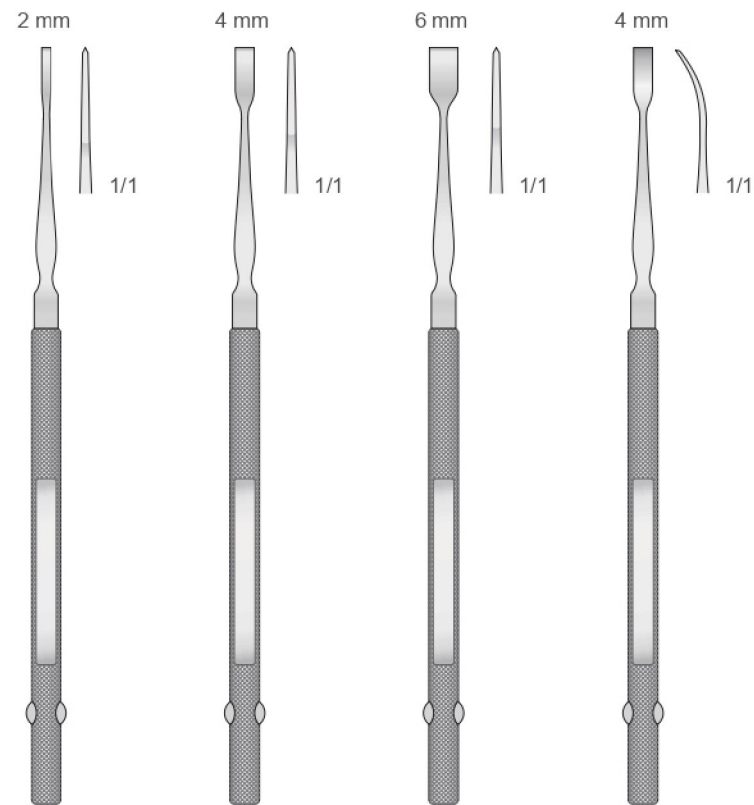
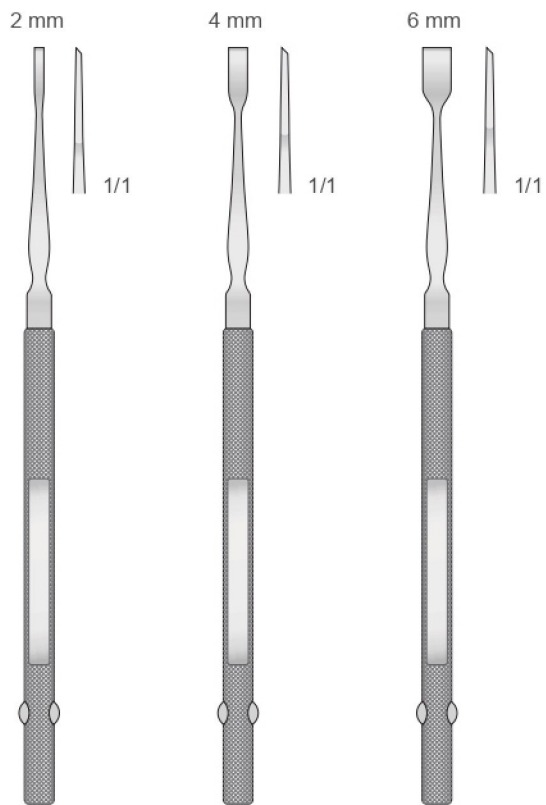

FREER
DI-TG-10
160 mm

FREER
DI-TG-11
160 mm

FREER
DI-TG-12
160 mm

FREER
DI-TG-20
160 mm

FREER
DI-TG-21
160 mm

FREER
DI-TG-22
160 mm

FREER
DI-TG-23
160 mm



Osteotome - Meißel
Osteotomes - Gouges
Osteotomi - Sgorbie
Osteótomos - Gubias
Ostéotomes - Gouges

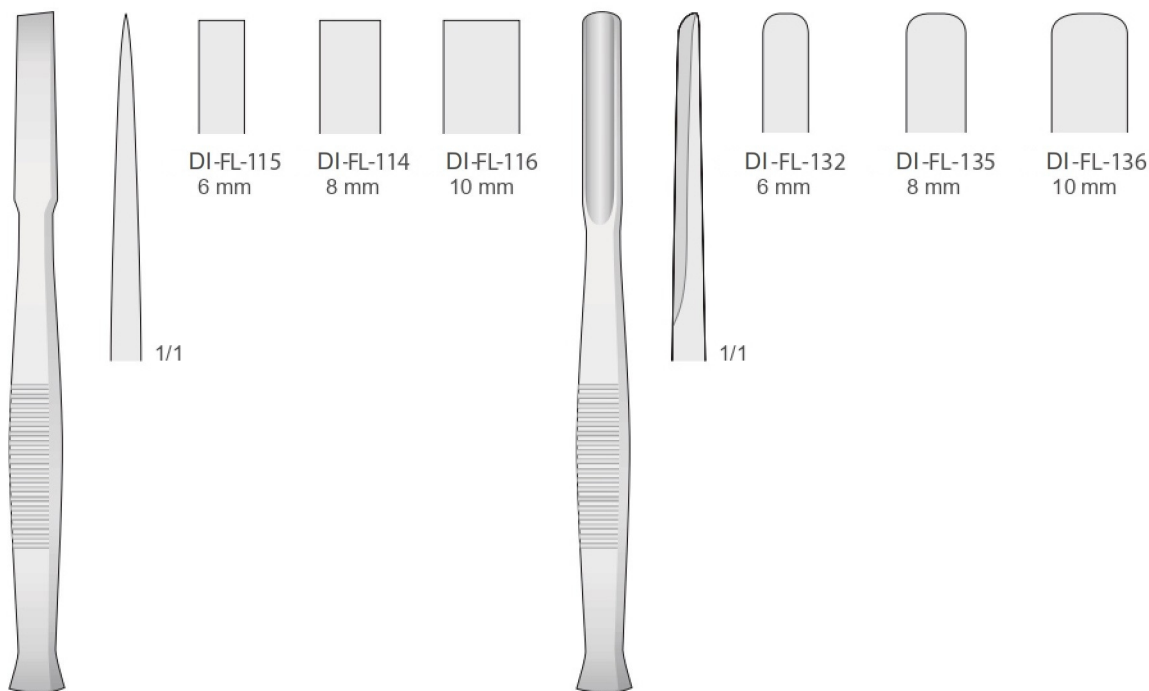

DI-FL-114/ DI-FL-116
140 mm

DI-FL-132/ DI-FL-136
140 mm

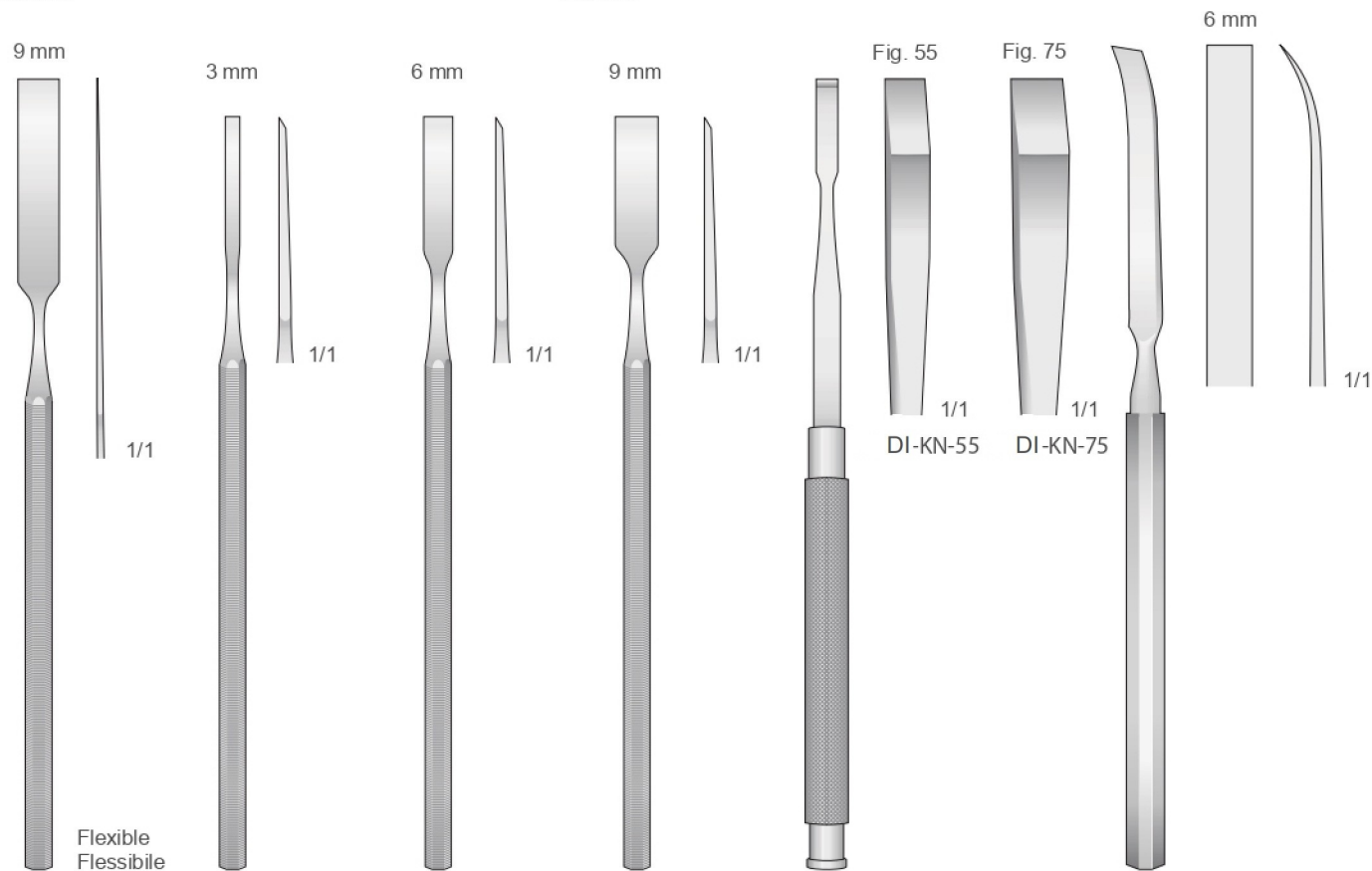

DI-TG-15
170 mm

DI-TG-30
155 mm

DI-TG-31
155 mm

DI-TG-32
155 mm

KRAMER-NEVINS
DI-KN-55/ DI-KN-75
175 mm

DI-DO-196
180 mm



Osteotome - Hohlmeißel
Osteotomes - Gouges
Osteotomi - Scalpelli
Osteótomos - Cinceles
Ostéotomes - Scalpel

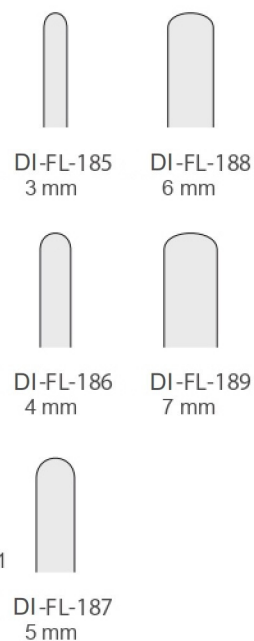
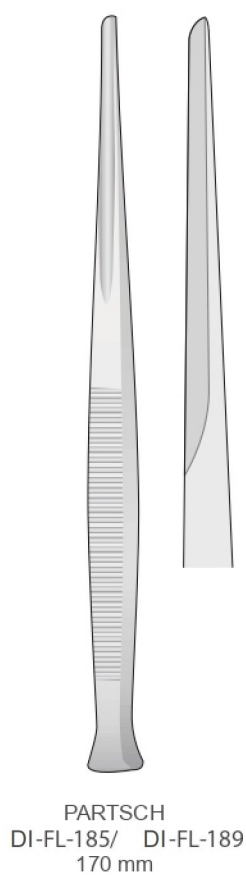
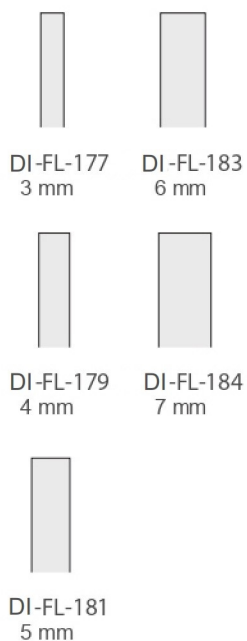
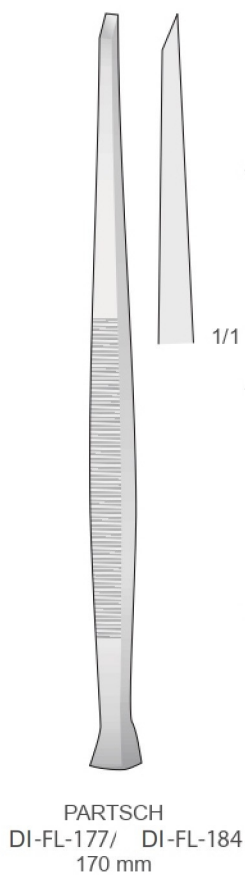
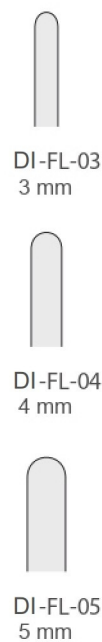
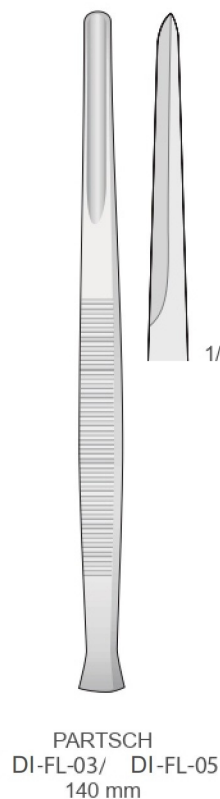
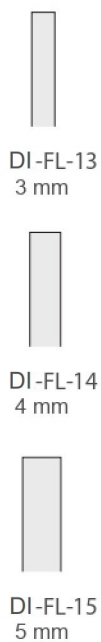
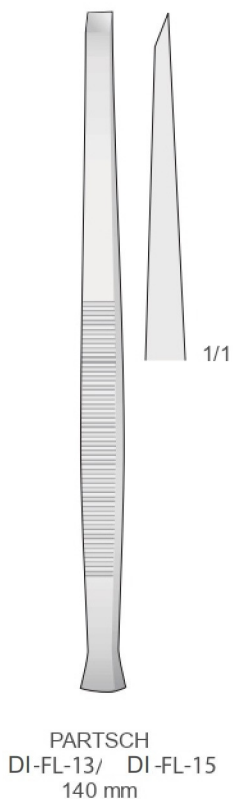



Osteotomes - Chisels
Osteotomi - Scalpelli
Osteótomos - Cinceles
Ostéotomes - Burins

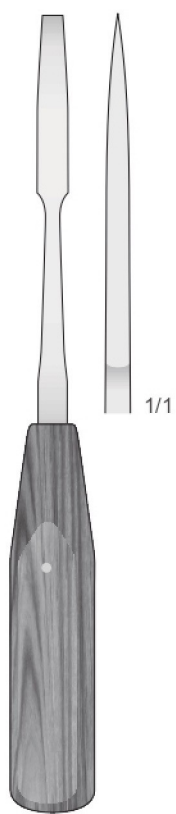

2 mm
DI-FL-59
4 mm
DI-FL-60
6 mm
DI-FL-61



4 mm
DI-FL-230
6 mm
DI-FL-231
8 mm
DI-FL-232

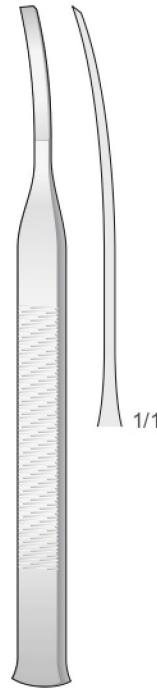

1/1



DI-FL-411 2 mm 1/1
DI-FL-414 3 mm 1/1
DI-FL-411 5 mm 1/1
DI-FL-416 7 mm 1/1

MINI-LEXER
DI-FL-59/ DI-FL-61
200 mm

MINI-LEXER
DI-FL-230/ DI-FL-232
180 mm

TESSIER
DI-FL-411 5 mm
DI-FL-412 7 mm
160 mm

TESSIER
DI-FL-413/ DI-FL-416
160 mm

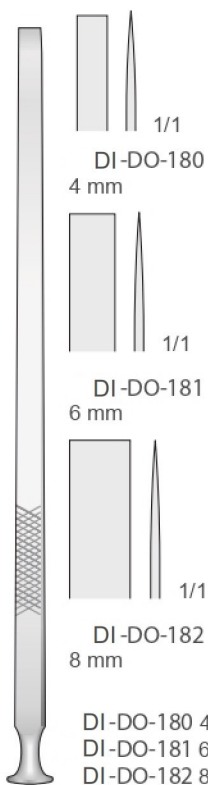

DI-DO-180 4 mm 1/1
DI-DO-181 6 mm 1/1
DI-DO-182 8 mm 1/1

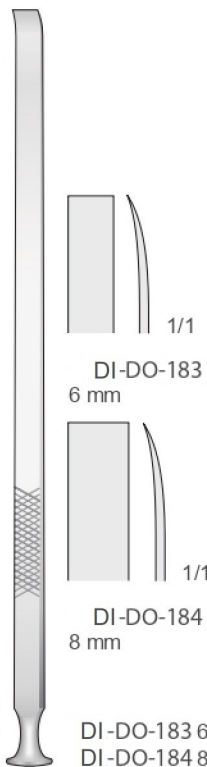

DI-DO-183 6 mm 1/1
DI-DO-184 8 mm 1/1

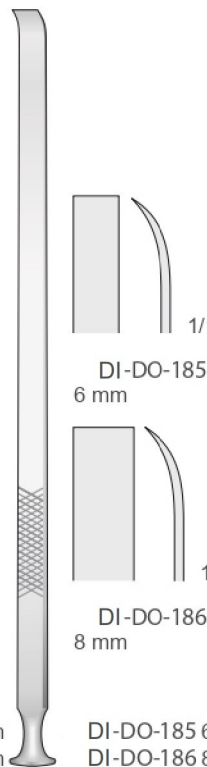

DI-DO-185 6 mm 1/1
DI-DO-186 8 mm 1/1

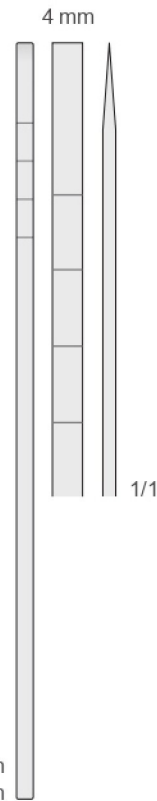

1/1

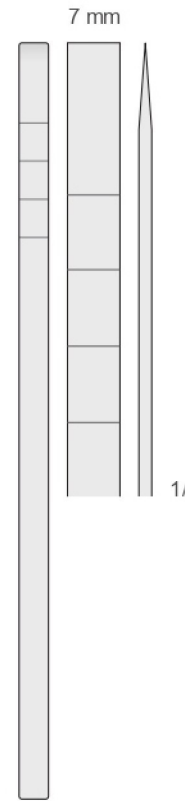

1/1

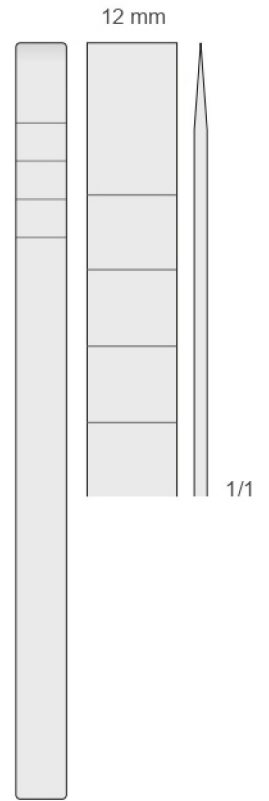

1/1

EPKER
DI-DO-180
ADM-DO-182
180 mm

EPKER
DI-DO-183
ADM-DO-184
180 mm

EPKER
DI-DO-185
ADM-DO-186
180 mm

COTTLE
DI-DO-140
180 mm

COTTLE
DI-DO-141
180 mm

COTTLE
DI-DO-143
180 mm



Chirurgische Hämmer
Surgical mallets
Martelli chirurgici
Martillos quirúrgicos
Maillets chirurgicaux

Ø 20 mm - 140 g



DI-FL-01
165 mm

Ø 25 mm - 300 g

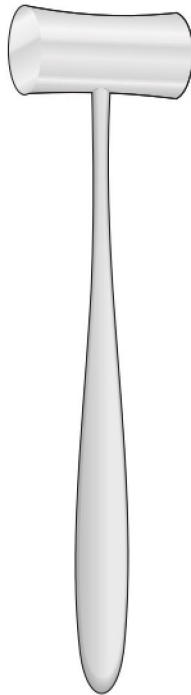

LUCAE
DI-FL-10M
190 mm

Ø 27 mm - 135 g

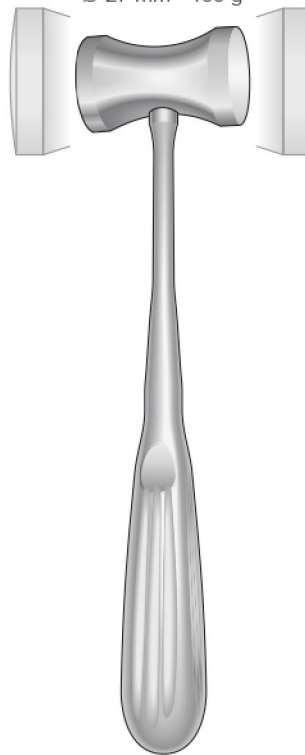

HAJEK
DI-FL-128
200 mm

Ø 30 mm - 240 g



COTTLE
DI-FL-104
185 mm

1 Seite flach - 1 Seite convex
1 Side flat - 1 Side convex
1 Lato piatto - 1 Lato convesso
1 Parte plana - 1 Parte convexe
1 Face plate - 1 Face convexe

Ø 20 mm - 160 g

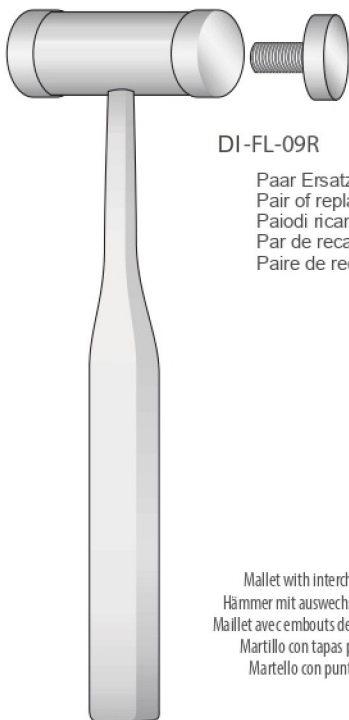

DI-FL-09R

Paar Ersatzbacken
Pair of replacement
Paiodi ricambio
Par de recambio
Paire de rechange

MEAD
DI-FL-09
190 mm

Ø 25 mm - 200 g

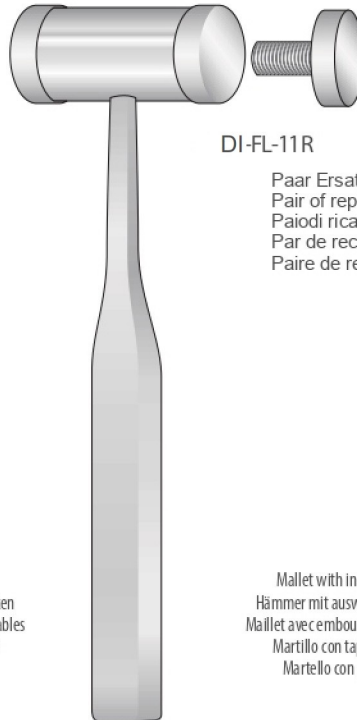

DI-FL-11R

Paar Ersatzbacken
Pair of replacement
Paiodi ricambio
Par de recambio
Paire de rechange

MEAD
DI-FL-11
200 mm

Mallet with interchangeable plastic disks
Hämmer mit auswechselbaren Kunststoffbacken
Maillet avec embouts de plastique interchangeable
Martillo con tapas plásticas reemplazables
Martello con punte di ricambi in teflon

Ø 26 mm - 320 g

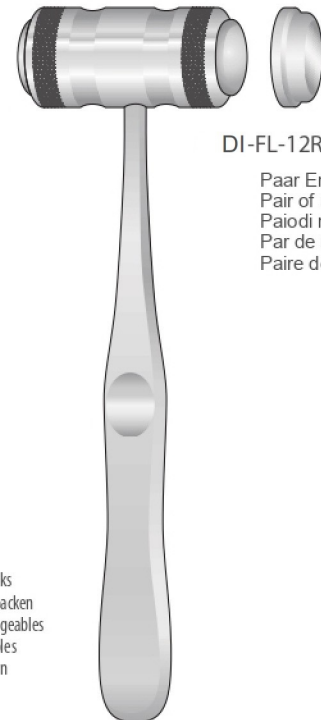

DI-FL-12R

Paar Ersatzbacken
Pair of replacement
Paiodi ricambio
Par de recambio
Paire de rechange

MEAD
DI-FL-12
190 mm

Mallet with interchangeable plastic disks
Hämmer mit auswechselbaren Kunststoffbacken
Maillet avec embouts de plastique interchangeable
Martillo con tapas plásticas reemplazables
Martello con punte di ricambi in teflon



Sinus Lift Retraktoren - Sinus Lift Retractors
Divaricatori per Sinus Lift - Separadores para Sinus Lift
Écarteurs pour Sinus Lift

Periosteals
Scollaperiosteai
Periostótomos
Rugines

17 mm



SAUTTER
DI-NK-249
145 mm

11 mm

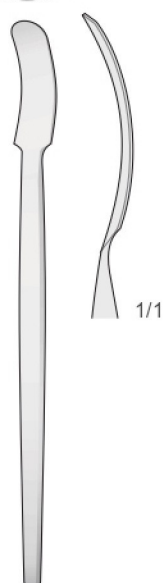

DI-NK-105
125 mm

9 mm

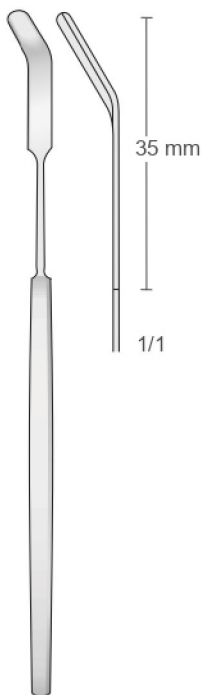

MODELL GIESSEN
DI-NK-251
160 mm

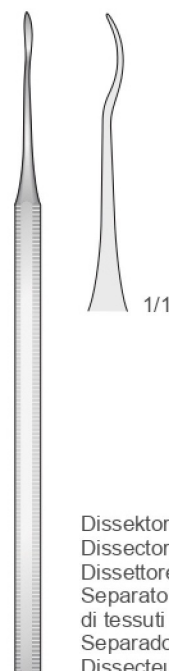

DI-ES-13
135 mm

Dissektor
Dissector
Dissettore
Separatore
di tessuti
Separadores
Dissecteur

4.5 mm

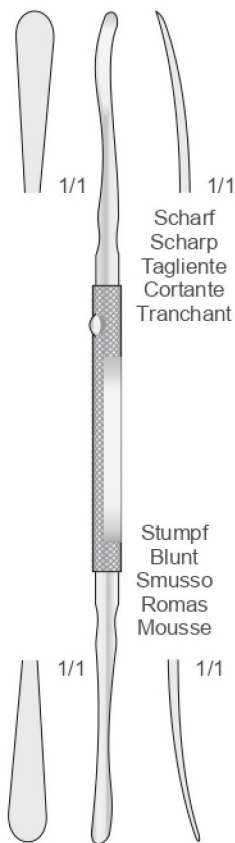

FREER
DI-FR-16
185 mm

Scharf
Sharp
Tagliente
Tranchant
Cortante

Stumpf
Blunt
Smusso
Romas
Mousse

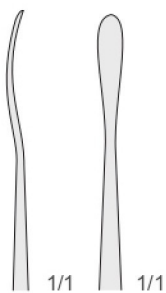

FREER
DI-FR-17
185 mm

Scharf
Sharp
Tagliente
Tranchant
Cortante

Blunt
Stumpf
Smusso
Romo

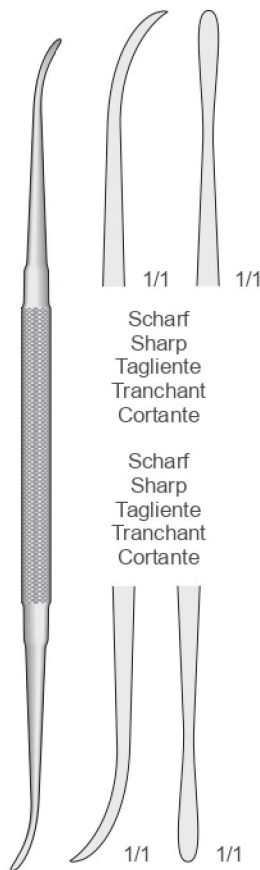

OBWEGESER-FREER
DI-718-215/ DI-718-216
220 mm

Scharf
Sharp
Tagliente
Tranchant
Cortante

Scharf
Sharp
Tagliente
Tranchant
Cortante

Stumpf
Blunt
Smussi
Romo
Mousse

DI-718-215
220 mm

DI-718-216
220 mm



Trepanbohrer
Trepines
Trepine
Trépanos
Trépan

Combination Trocar-Trephine Instruments

Bestehend aus einem Trokar, einer gezahnten Trepine und einem Kolben zur Entnahme von Knochen-Transplantaten aus Tibia und Beckenkamm mittels eines geschlossenen Verfahrens

Consisting of trocar, a toothed trephine and a plunger for taking tibial and iliac bone grafts through a closed technique

Composto di un trequarti, una camicia dentata ed un pistone per il prelievo degli innesti ossei dalla tibia e dalla cresta iliaca tramite una tecnica chirurgica intracutanea

Compuesto por un trócar, un trépano dentado y un émbolo para obtener injertos óseos tibiales e iliacos mediante una técnica cerrada

Composé d'un trocart, d'une tréphine dentée et d'un piston pour le prélèvement de greffes osseuses de la tibia ou de la crête iliaque par une technique fermée

ADM-FK-100

Komplettset mit 4 Teilen
Set complete with 4 pieces
Set completo di 4 pezzi
Set completo con 4 piezas
Set complet avec 4 pièces

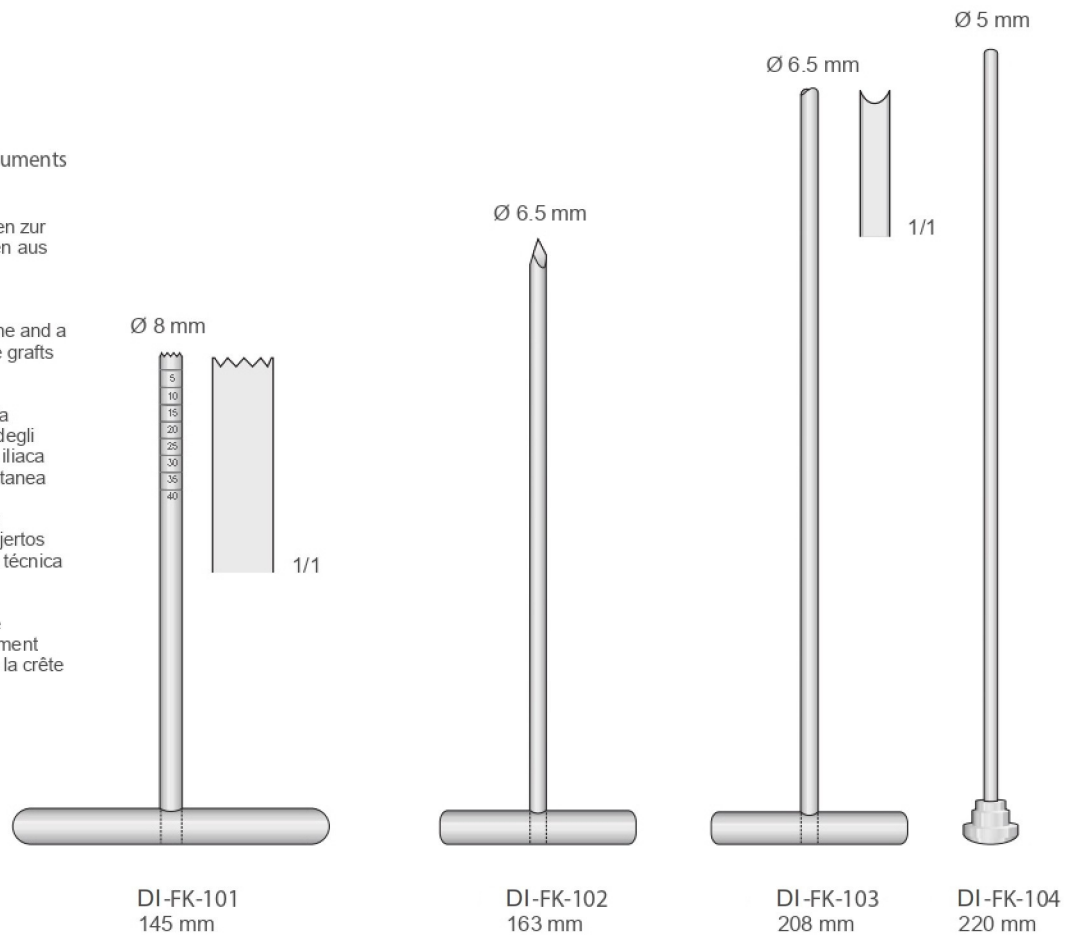

DI-FK-105

Komplettset mit 4 Teilen
Set complete with 4 pieces
Set completo di 4 pezzi
Set completo con 4 piezas
Set complet avec 4 pièces

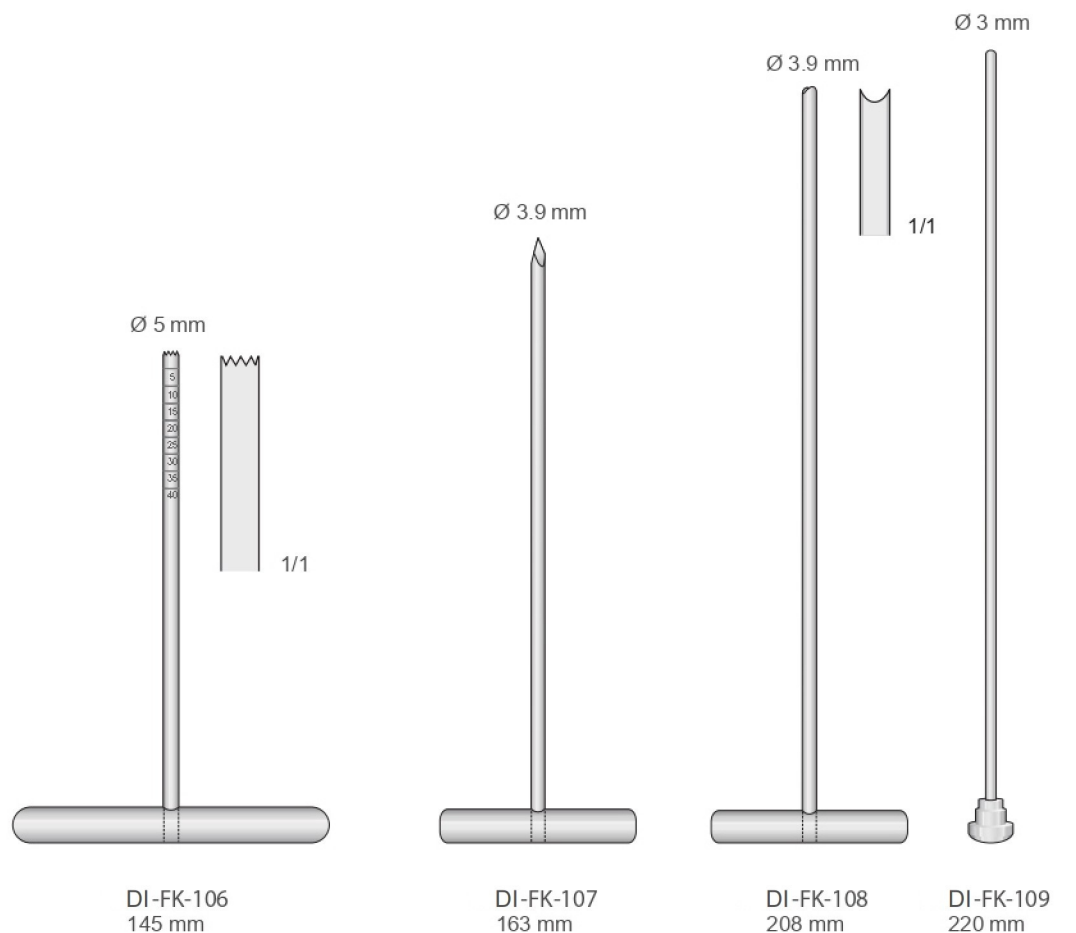



Implantologie Instrumente
Implantology Instruments
Strumenti per implantologia
Instrumentos para Implantología
Instruments pour Implantologie

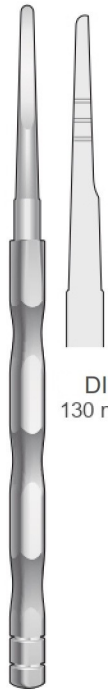

DI-MIR-30
130 mm



DI-MIR-31
130 mm



DI-MIR-32
130 mm



DI-MIR-33
130 mm

BONE EXPANDERS
Distraktoren für Knochenleiste
Distracteurs de crête osseuse
Expansores de cresta ósea
Distrattori per cresta ossea

TUNNELING INSTRUMENTS

Tunnelierinstrumente | Instruments pour tunnellation | Instrumentos para tunelización | Strumenti per tunneling



DI-UST-1/2ML



DI-UST-1/2MS



DI-UST-KPA

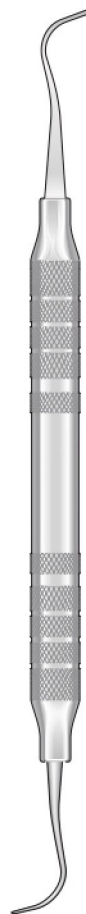

DI-YG7/8



DI-UST-MP



DI-UST-MPA



Osteotome
Osteotomes
Osteotomi
Osteótomos
Ostéotomes

ADM-FL-400
IMPLANT SINUS LIFT OSTEOTOMES SET
ADM-FL-391 + ADM-FL-392 + ADM-FL-393 + ADM-FL-394
+ADM-FL-395 + ADM-FL-396 + ADM-FL-397 + ADM-FL-398 + ADM-FL-399
(1 + 2 + 3 + 4 + 5 + 6 + 7 + 8 + 9)
+ ADM-BS-60 (Stainless Steel Container)

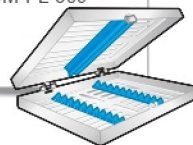

ADM-FL-400M
COMPLETE IMPLANT SINUS LIFT OSTEOTOMES SET
ADM-FL-389 + ADM-FL-390 + ADM-FL-391 + ADM-FL-392 + ADM-FL-393
+ ADM-FL-394 + ADM-FL-395 + ADM-FL-396 + ADM-FL-397 + ADM-FL-398 + ADM-FL-399
(00 + 0 + 1 + 2 + 3 + 4 + 5 + 6 + 7 + 8 + 9)
+ ADM-BS-60 (Stainless Steel Container)

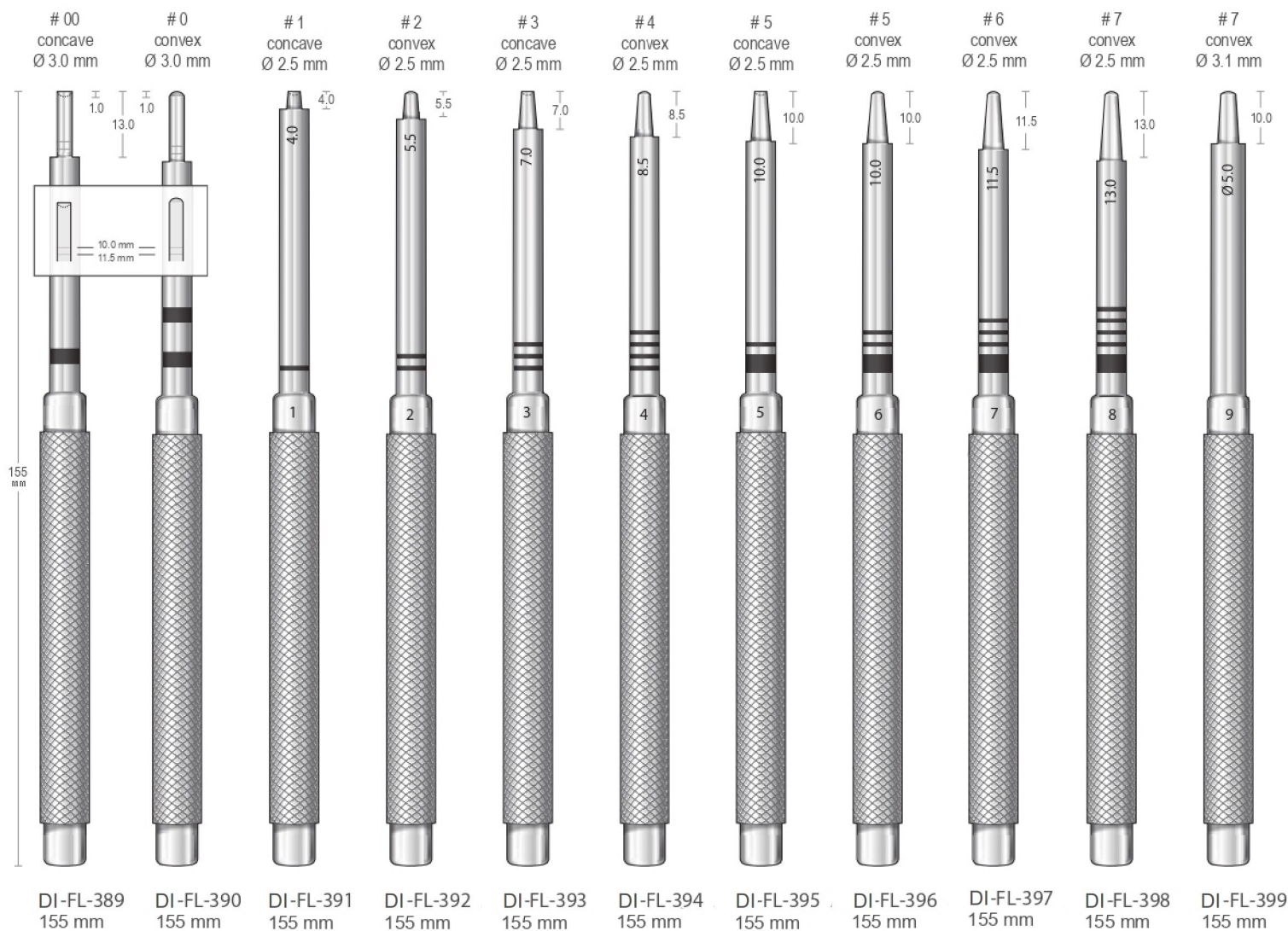
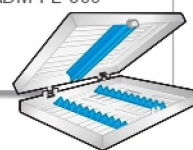



Osteotome
Osteotomes
Osteotomi
Osteótomos
Ostéotomes

# 1	Diam.
0	Ø 1.60
7.5	Ø 1.80
10	Ø 2.00
13.5	Ø 2.40
15.5	Ø 3.60

# 2	Diam.
0	Ø 1.90
7.5	Ø 2.20
10	Ø 2.35
13.5	Ø 3.30
15.5	Ø 3.40
23.5	Ø 4.50

# 3	Diam.
0	Ø 2.80
7.5	Ø 3.20
10.5	Ø 3.35
13.5	Ø 3.60
21	Ø 4.40

# 4	Diam.
0	Ø 3.10
7.5	Ø 3.70
10.5	Ø 3.90
15.5	Ø 4.30

# 5	Diam.
0	Ø 3.90
10	Ø 5.00
13	Ø 5.20
20.5	Ø 6.30

# 6	Diam.
0	Ø 5.50
10	Ø 6.20
13	Ø 6.30

1
Ø 1.6 mm



DI-FL-120
155 mm

2
Ø 1.9 mm



DI-FL-121
155 mm

3
Ø 2.8 mm



DI-FL-122
155 mm

4
Ø 3.10 mm



DI-FL-123
155 mm

5
Ø 3.90 mm



DI-FL-124
155 mm

6
Ø 5.50 mm



DI-FL-125
155 mm



Osteotome
Osteotomes
Osteotomi
Osteótomos
Ostéotomes

# 1	Diam.	# 2	Diam.	# 3	Diam.	# 4	Diam.	# 5	Diam.
0	Ø 1.50	0	Ø 2.10	0	Ø 2.60	0	Ø 3.00	0	Ø 3.50
5	Ø 1.90	5	Ø 2.60	5	Ø 3.00	5	Ø 3.50	5	Ø 3.90
8	Ø 2.20	8	Ø 2.80	8	Ø 3.30	8	Ø 3.80	8	Ø 4.20
10	Ø 2.40	10	Ø 3.00	10	Ø 3.50	10	Ø 4.00	10	Ø 4.40
12	Ø 2.60	12	Ø 3.20	12	Ø 3.70	12	Ø 4.20	12	Ø 4.60
14	Ø 2.80	14	Ø 3.40	14	Ø 3.90	14	Ø 4.40	14	Ø 4.80

Straight
Gerade
Droit
Recto
Diritto

Bone Pusher

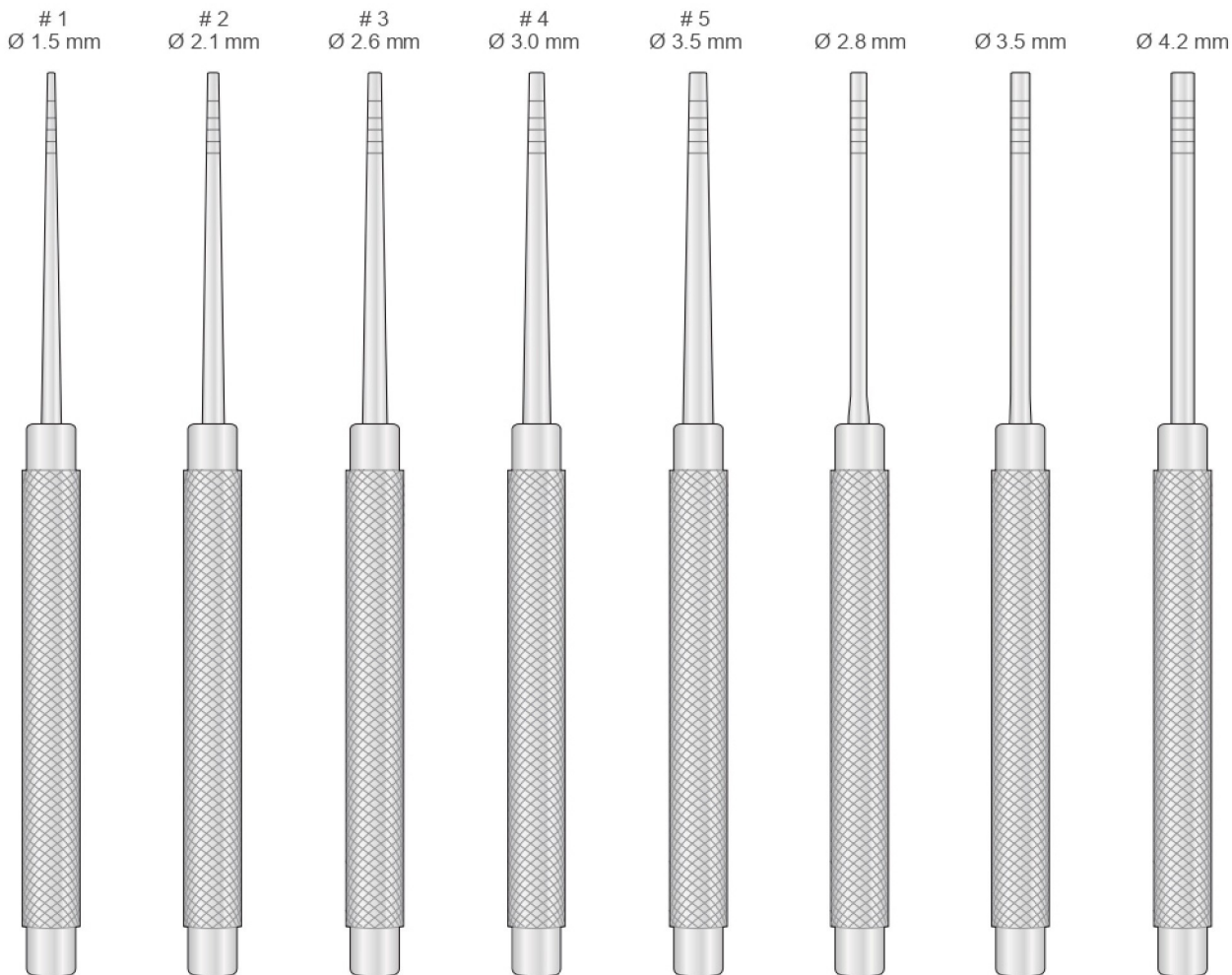

BI-FL-292
55 mm

BI-FL-293
155 mm

BI-FL-294
155 mm

BI-FL-295
155 mm

BI-FL-296
155 mm

BI-FL-297
155 mm

BI-FL-298
155 mm

BI-FL-299
155 mm



Osteotome
Osteotomes
Osteotomi
Osteótomos
Ostéotomes

Meißeln Graduiert
Graduated Chisels
Scalpelli graduati
Cinceles graduados
Burins gradués

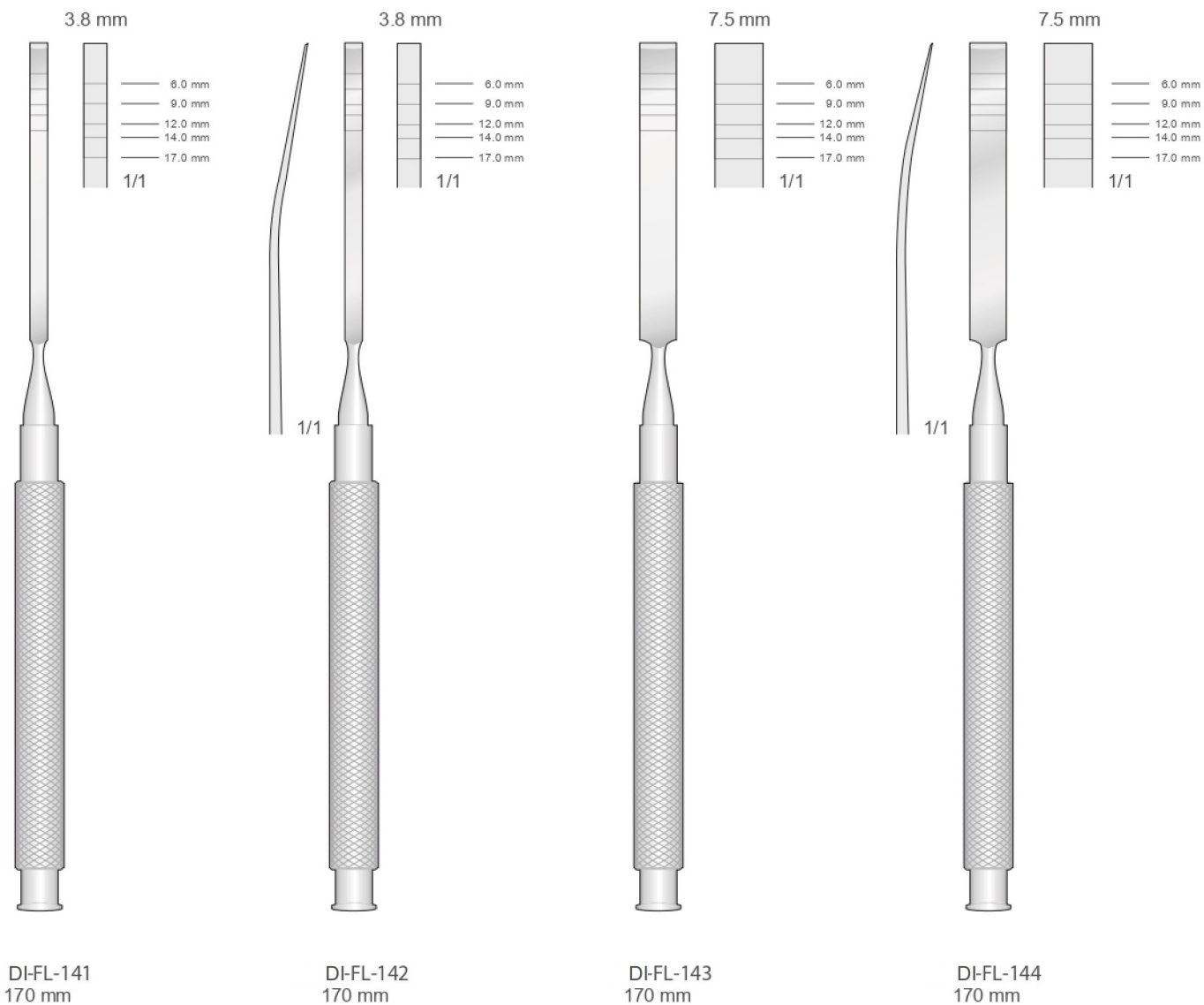



Osteotome
Osteotomes
Osteotomi
Osteótomos
Ostéotomes

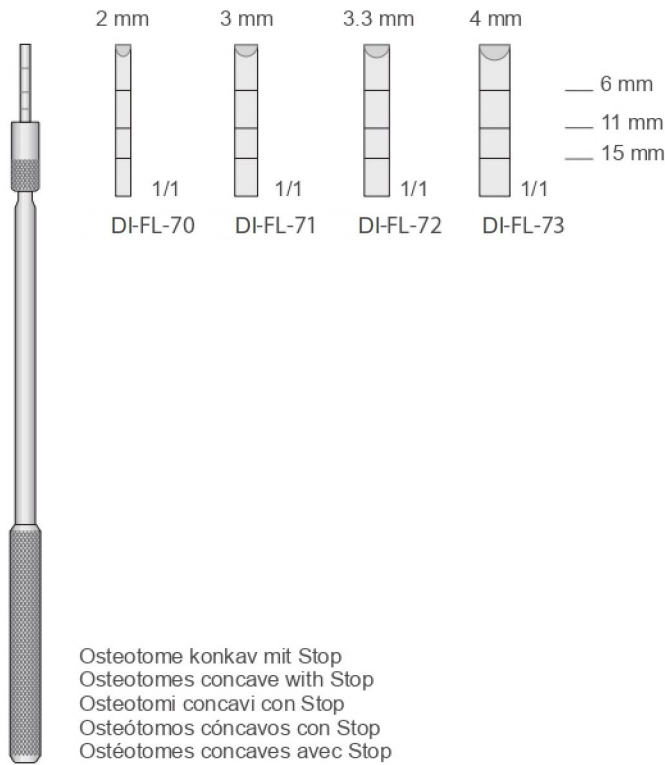

DI-FL-70/ DI-FL-73
165 mm

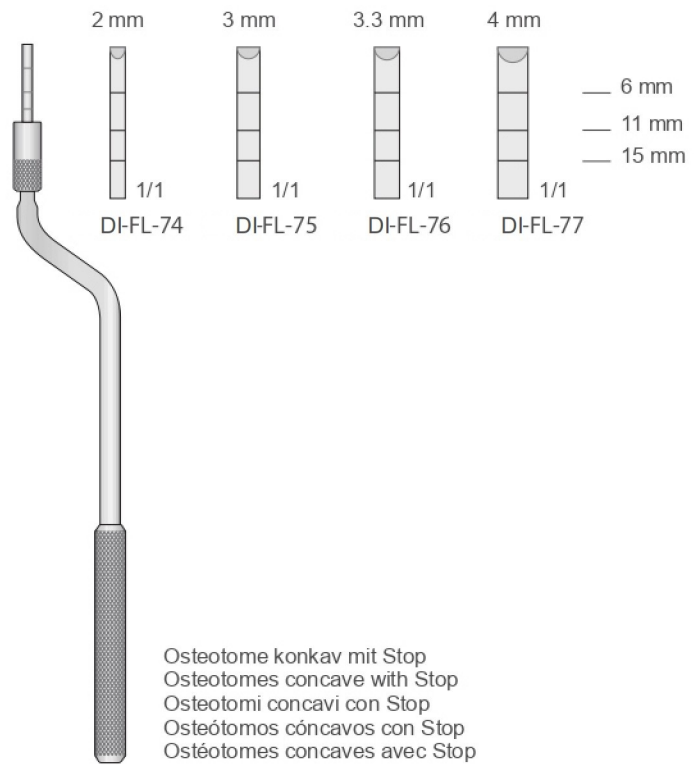

DI-FL-74/ DI-FL-77
165 mm

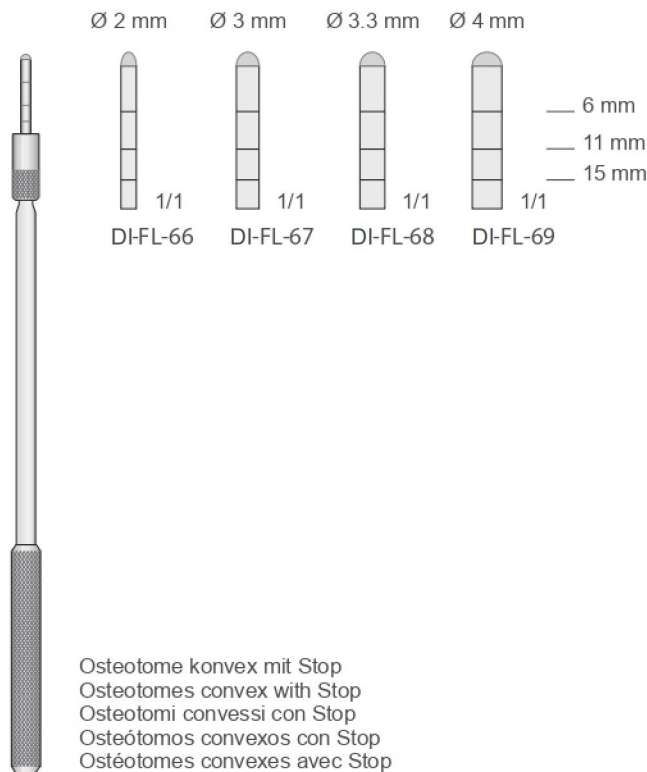

DI-FL-66/ DI-FL-69
165 mm

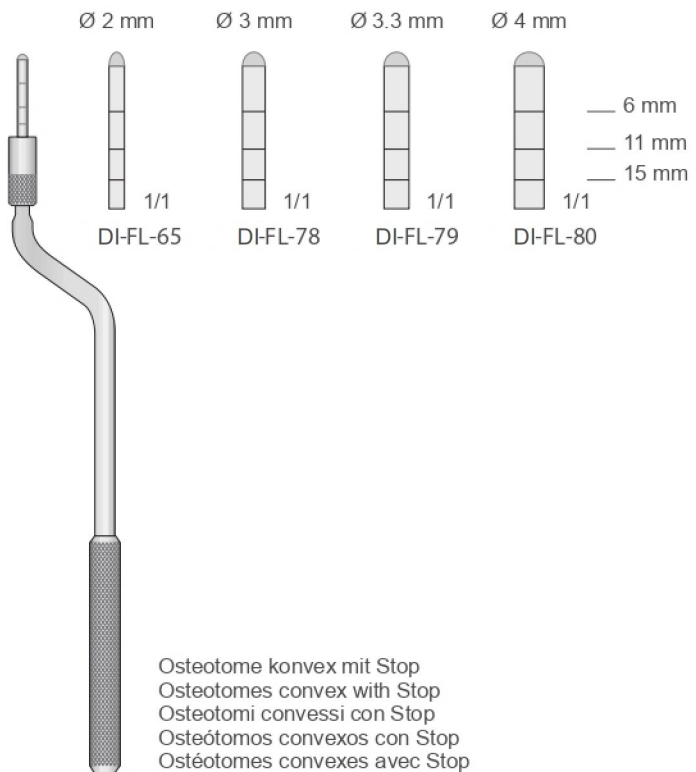

DI-FL-65/ DI-FL-80
160 mm



Osteotome
Osteotomes
Osteotomi
Osteótomos
Ostéotomes

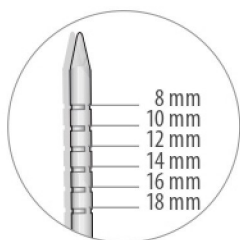

Dilatator
Dilator
Dilatatori
Dilatador
Dilatateur

A-Form

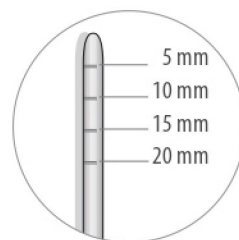

Spreader
Spreader
Expansori
Expansor
Expandeur

D-Form
Convex Tip

Ø 2 mm



DI-FL-25
145 mm

Ø 3 mm



DI-FL-26
145 mm

Ø 3.3 mm



DI-FL-27
145 mm

Ø 4 mm



DI-FL-28
145 mm

Ø 3 mm



DI-FL-37
145 mm

Ø 4 mm



DI-FL-38
145 mm

Ø 5 mm



DI-FL-39
145 mm



Trepanbohrer
Trepines
Trepine
Trépanos
Trépan

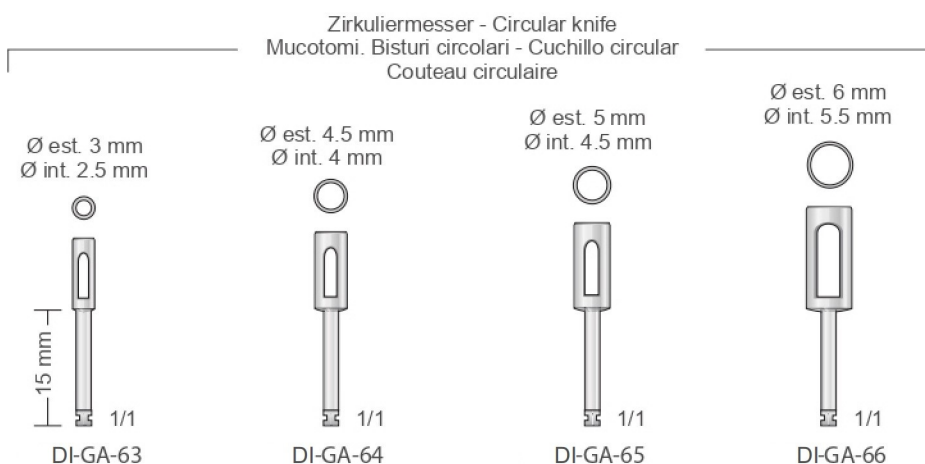
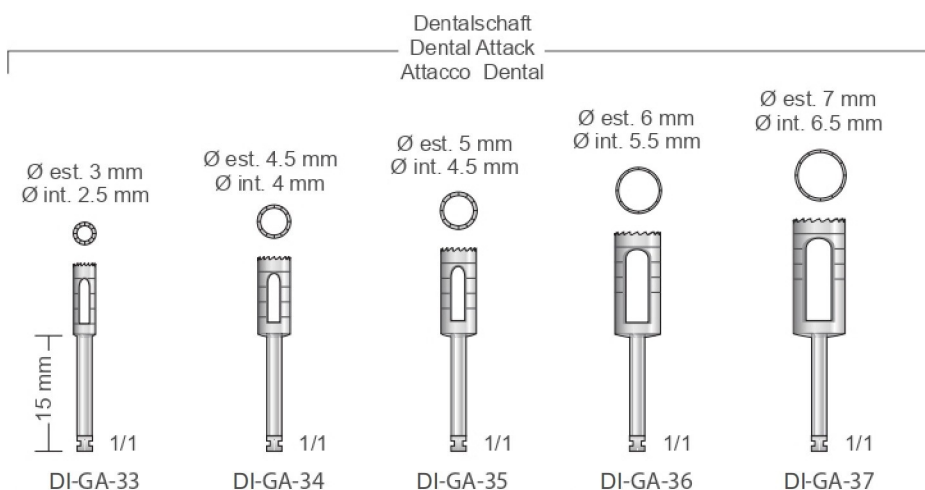

Hautstanzen - Tissue punches
Mucotomi Punches - Instrumentos para cortar tejidos
Instruments à couper le tissue

Implant Graduierung
Implant depth gauge with ball end
Sonda per controllare la profondità del sito
Sonda para controlar la profundidad

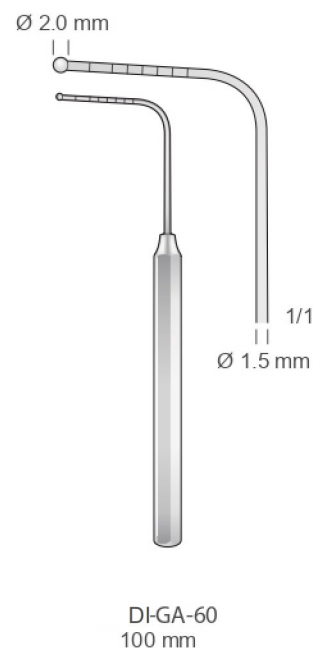
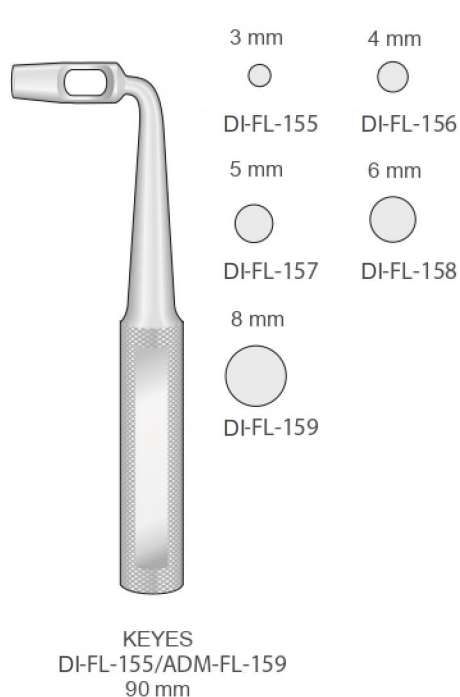
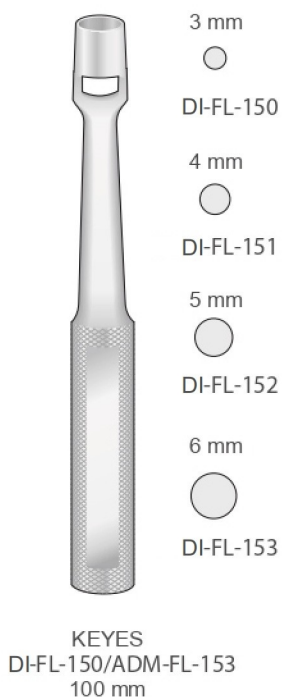



Implantologie Instrumente
Implantology Instruments
Strumenti per implantologia
Instrumentos para Implantología
Instruments pour Implantologie

Knochenschale
Bone Well
Bacinella per osso
Cubeta para hueso
Cuvette à os



Rostfrei
Stainless Steel
Acciaio inossidabile
Acero inoxidable
Acier Inoxydable

DI-SS-65
35 mm

Absaugkanülen für Knochen. mit Filter
Suction tube for bone. with filter
Cannule d'aspiration con trattenuta osso. con filtro
Cánulas aspiradoras para hueso. con filtro
Canule d'aspiration pour os avec filtre

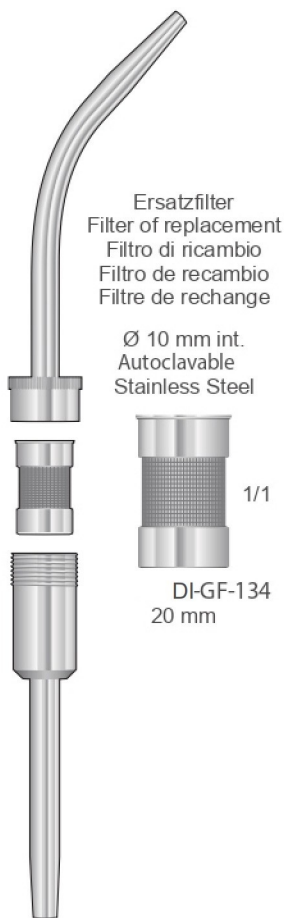

Ersatzfilter
Filter of replacement
Filtro di ricambio
Filtro de recambio
Filtre de recharge

Ø 10 mm int.
Autoclavable
Stainless Steel

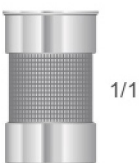

DI-GF-134
20 mm

DI-GF-133
180 mm

Membranplatzierungsinstrumente
Membrane Placement Instruments
Strumenti per posizionare membrana
Instrumentos para colocar membranas
Instruments pour application de membrane

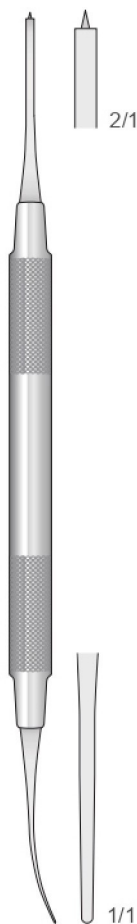

DI-MPI-1
185 mm

Aufbring Instrument für Knochenmaterial
Applicator for bone material
Aplicatore per materiale osseo
Cucharillas para material oseu
Applicateur pour matière osseuse

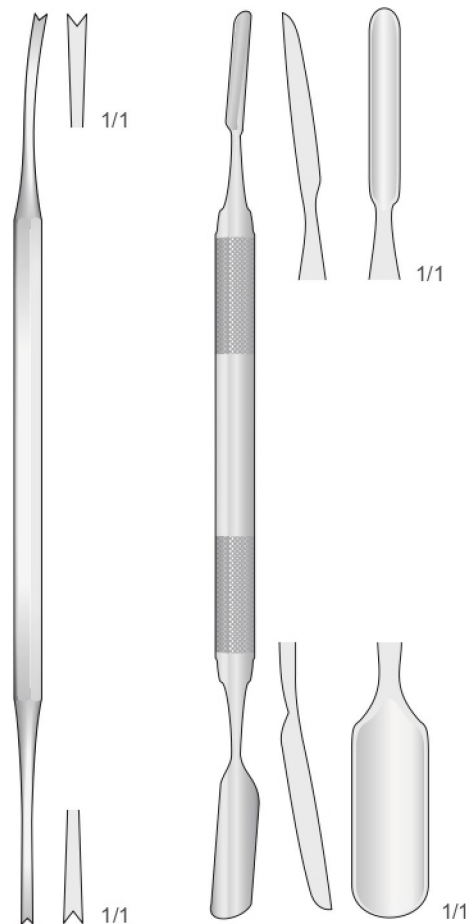

LUNIATSCHEK
DI-PF-6
170 mm

DI-IM-15
180 mm



Knochenmühlen - und spritzen
Bone Mills and Syringes
Macina e siringhe per osso
Molinos y jeringas para hueso
Moulines et seringues à os



DI-GA-18
Lower
Titanium



DI-GA-17
Upper
Titanium



DI-GA-19
Handle
with screw

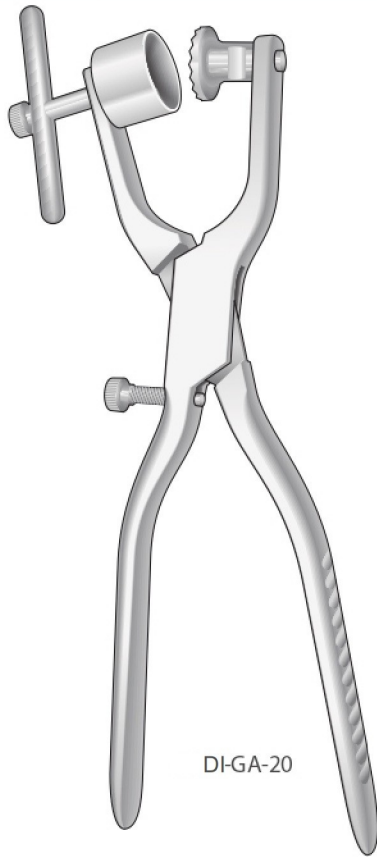

DI-GA-20

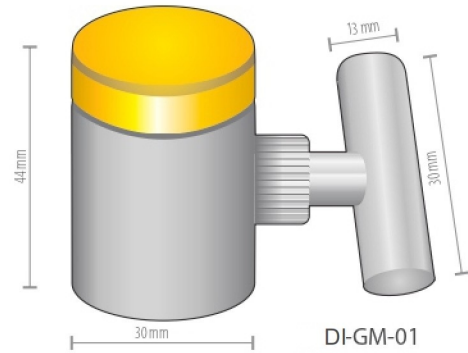

DI-GM-01
Small

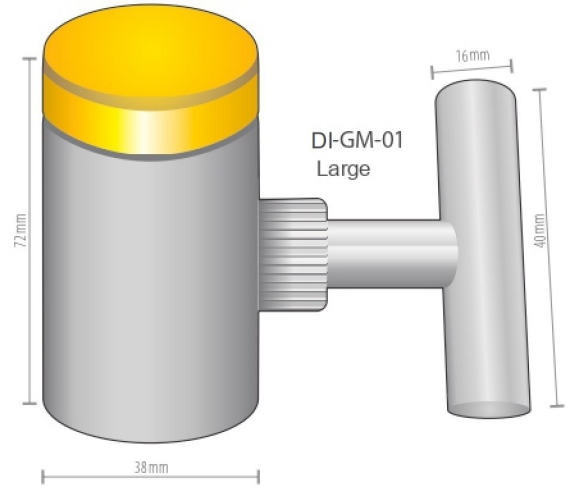

DI-GM-01
Large

Ø Int. 2.5 mm
Ø Est. 3.5 mm

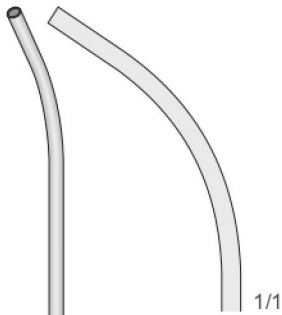

1/1

Ø Int. 3.5 mm
Ø Est. 4.5 mm

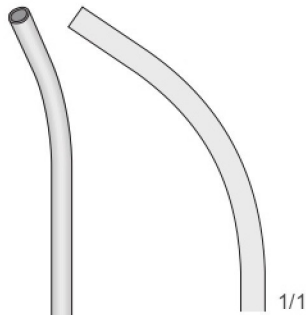

1/1

Ø Int. 4.4 mm
Ø Est. 5.5 mm

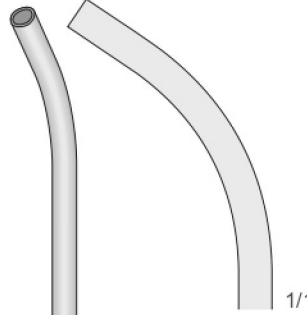

1/1

Ø Int. 6 mm
Ø Est. 7 mm

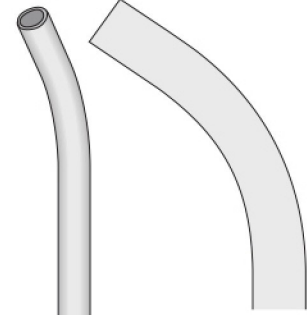

1/1

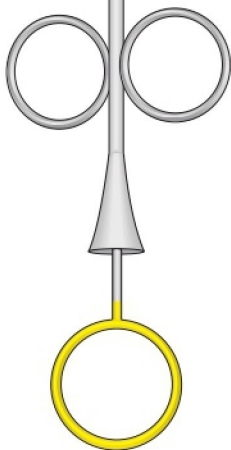

DI-SS-60M
160 mm

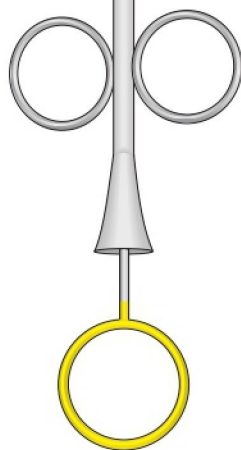

DI-SS-61M
160 mm

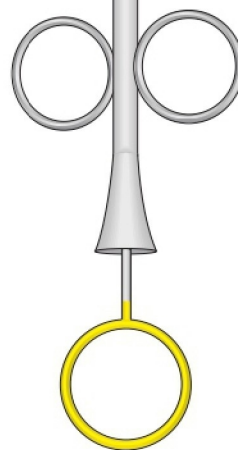

DI-SS-62M
160 mm

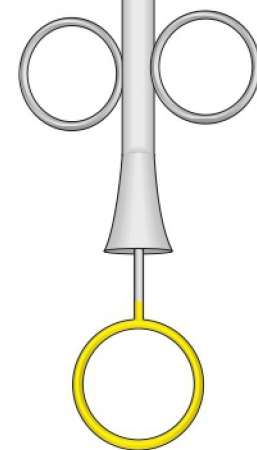

DI-SS-64M
160 mm



Knochenstößer
Bone Tampers - Bone Grafting Packers
Compattatore per osso
Compactador para hueso
Compacteur à os



	Non Serrated Tips		Serrated Tips	
DI-USB-P1	○ Ø 1.8	○ Ø 2.8	● Ø 1.8	● Ø 2.8
DI-USB-P2	○ Ø 3.2	○ Ø 3.8	● Ø 3.2	● Ø 3.8
DI-USB-P3	○ Ø 4.2	○ Ø 4.8	● Ø 4.2	● Ø 4.8
DI-USB-P4	○ Ø 5.0	○ Ø 5.5	● Ø 5.0	● Ø 5.5

Ø 3 mm

Ø 5 mm

Ø 4 mm

Ø 3 mm

Ø 5 mm

3 mm

6 mm

4 mm

8 mm

Misura interna

DI-SS-20 Ø 3 mm

DI-SS-21 Ø 4 mm

DI-SS-22 Ø 5 mm

DI-FL-20
155 mm

ADM-FL-21
155 mm

DI-FL-31
155 mm

DI-FL-33
155 mm

DI-FL-35
155 mm

DI-OADM-P-7
170 mm

DI-OADM-P-8
170 mm

FOITZIK
DI-SS-20/ADM-SS-22
140 mm



Knochenschaber, Knochenträger
Bone-Grafter, Stainless Steel
Grattini per osso, Inox
Raspador de hueso, Acero inoxidable
Racleur d'os, Acier inoxydable

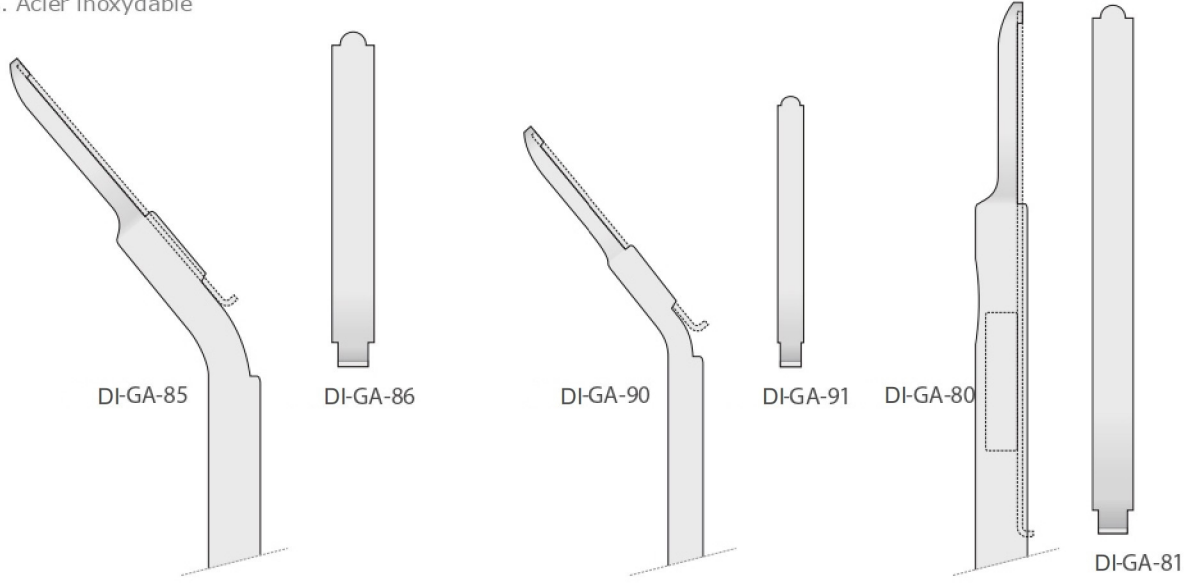

Knochenschaber mit Reibeklinge
Bone-Grafter with blade
Grattino con lama
Raspador de hueso con hoja
Racleur d'os avec lame

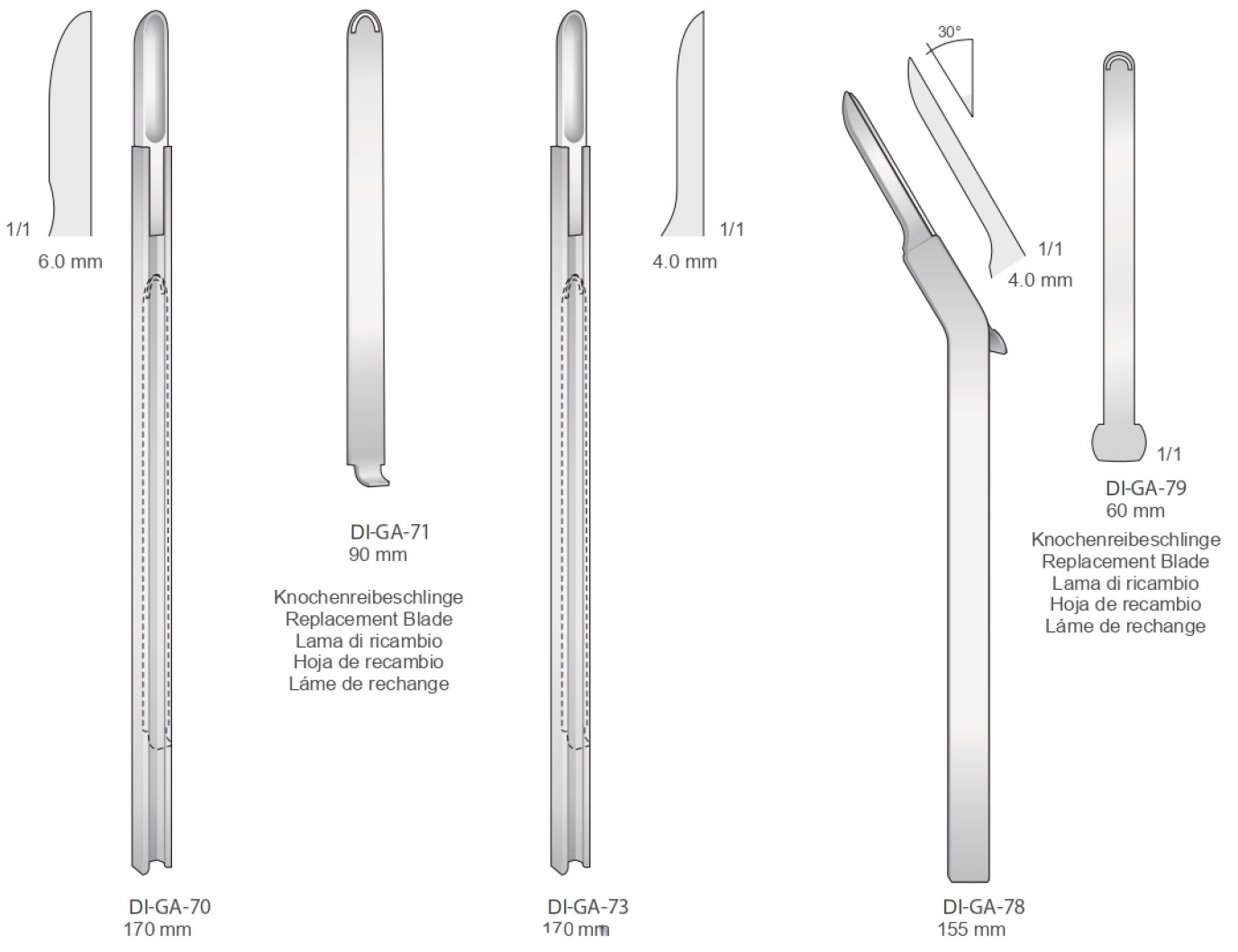



Messinstrumente
Measuring instruments
Strumenti per misura
Instrumentos para medir
Instruments à mesurer

Meßbereich: 0 - 20 mm
Measuring range: 0 - 20 mm
Campo di misura: 0 - 20 mm
Alcance de medición: 0 - 20 mm
Etendue de mesure: 0 - 20 mm

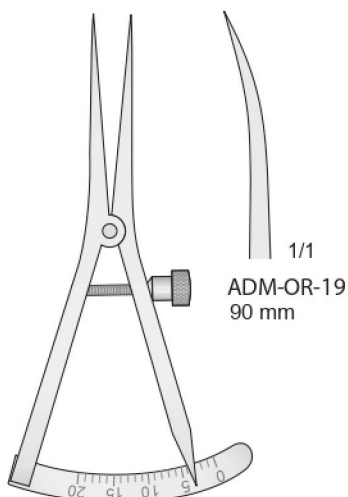

1/1
ADM-OR-19
90 mm

DI-OR-19
CASTROVIEJO
90 mm



DI-LS-08
100 mm



DI-LS-09
200 mm

Meßbereich: 0 - 80 mm
Measuring range: 0 - 80 mm
Campo di misura: 0 - 80 mm
Alcance de medición: 0 - 80 mm
Etendue de mesure: 0 - 80 mm



DI-OR-40
125 mm

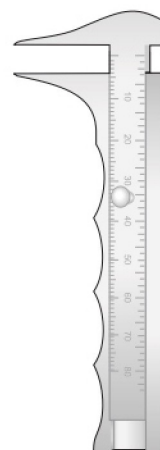

DI-OR-45
95 mm

0 - 40 mm
Meßbereich / Measuring range / Campo di misura
Alcance de medición / Etendue de mesure

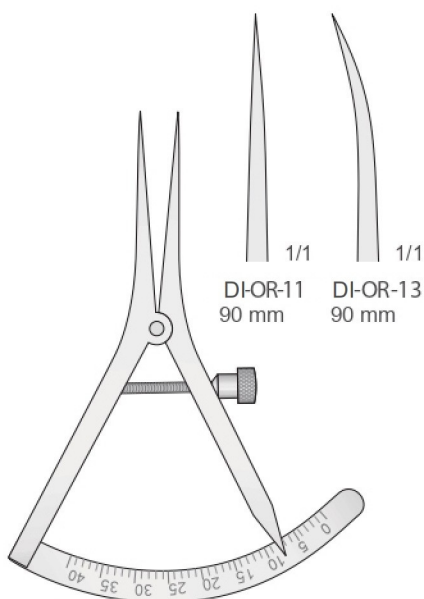

1/1 1/1
DI-OR-11 DI-OR-13
90 mm 90 mm

CASTROVIEJO
DI-OR-11/ DI-OR-13
90 mm

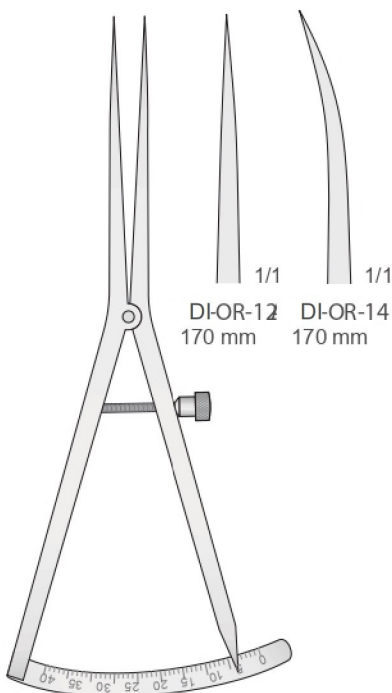

1/1 1/1
DI-OR-12 DI-OR-14
170 mm 170 mm

CASTROVIEJO
DI-OR-12/ DI-OR-14
170 mm

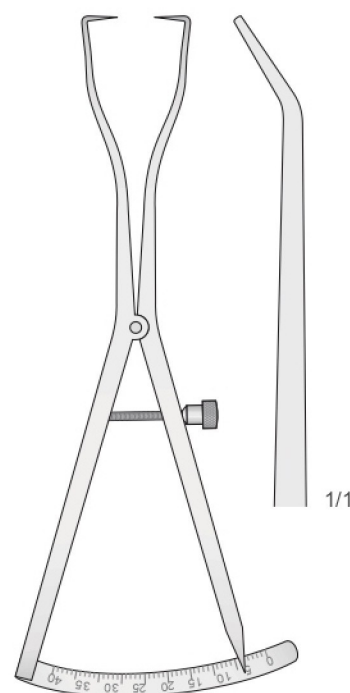

1/1
CASTROVIEJO
DI-OR-18
170 mm



Osteometer
Osteometer
Osteometro
Osteometro
Osteometer

TRIDIMENSIONAL IMPLANTOLOGY CALIPER

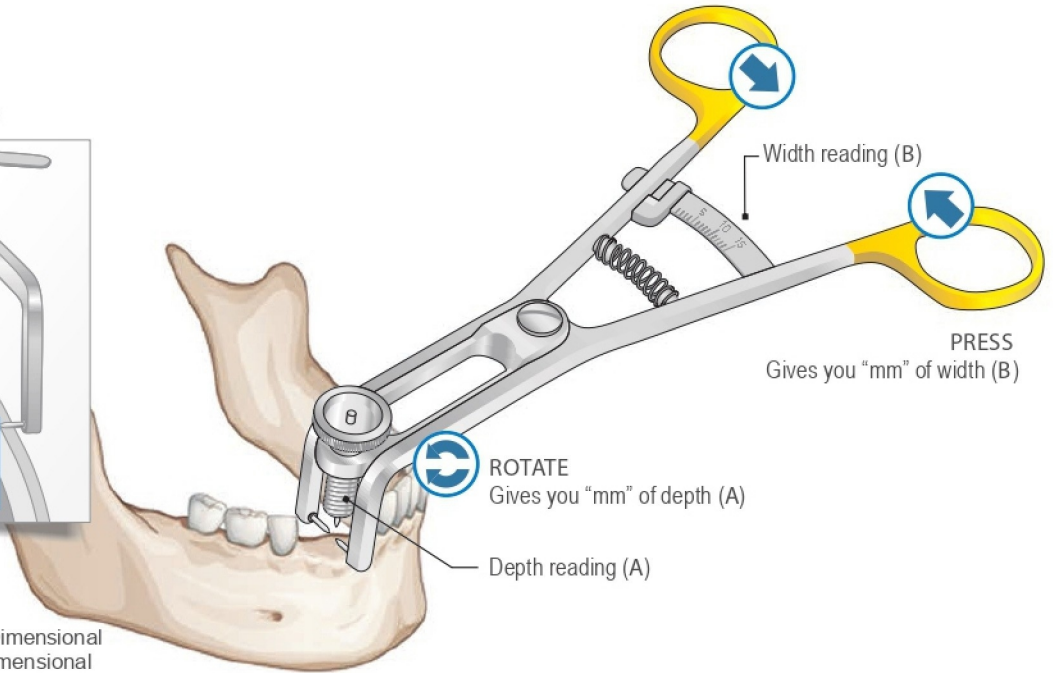
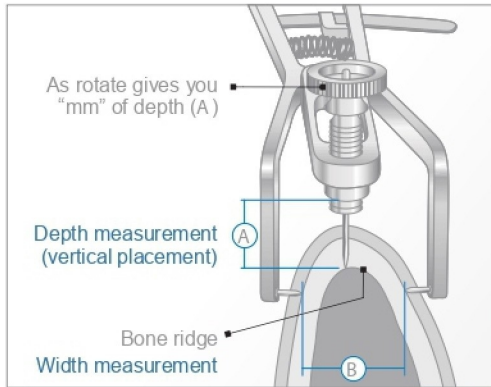

DB-300

Schieblehre für Implantologie
Implantology Calliper
Calibro per Implantologie
Calibre para Implantología
Calibre pour Implantologie

Trei-Dimensional
Tridimensional
Tridimensionale
Tridimensional
Tridimensionnel

BONE BLOCK CLAMP
Bone Holding Clamps
Knochenhalteklammern
Daviers à os
Pinzas de sujeción para hueso
Pinze per fissare l'osso

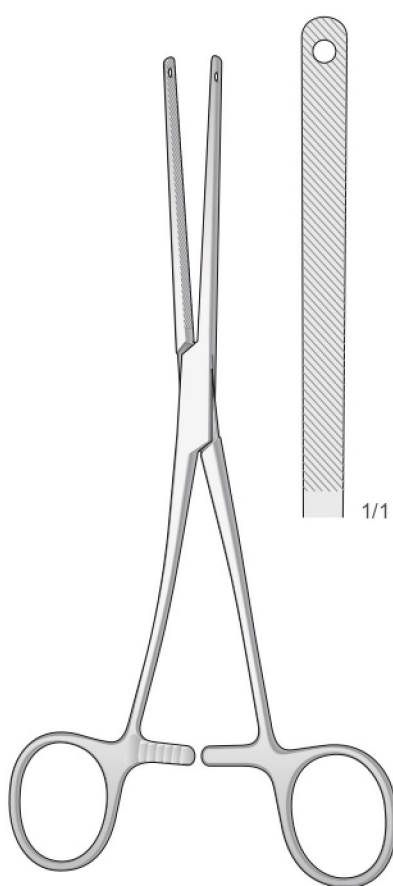

DI-P-340
220 mm

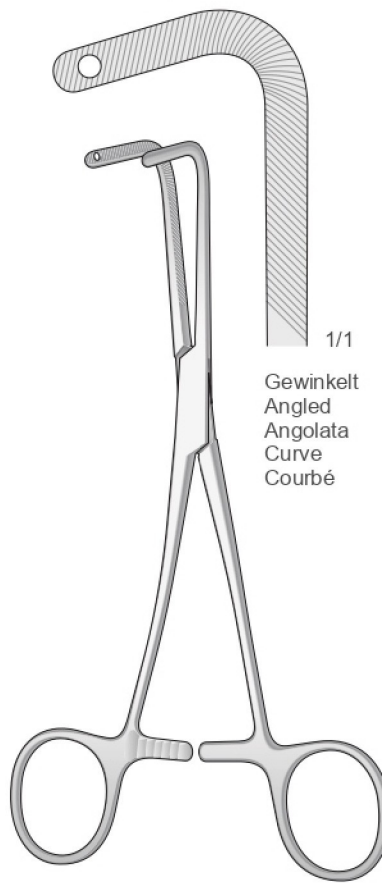

DI-P-341
200 mm

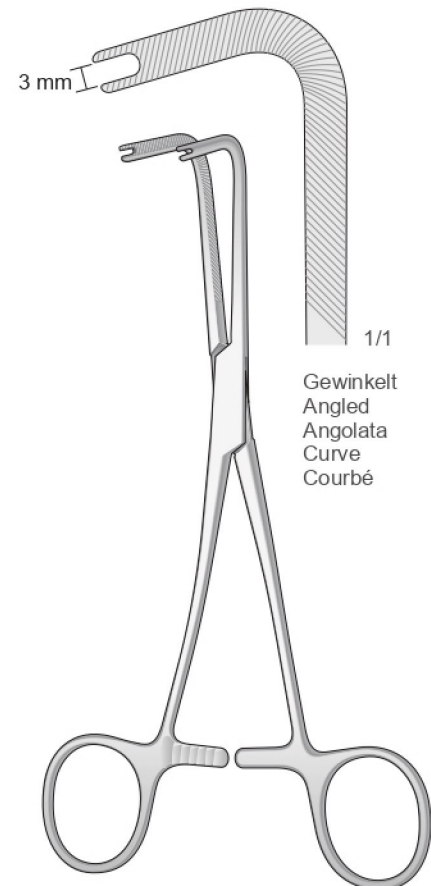

DI-P-342
200 mm

Gewinkelt
Angled
Angolata
Curve
Courbé

Gewinkelt
Angled
Angolata
Curve
Courbé



Retraktoren - Knochenhaltezeuge
Retractors - Bone Holding Forceps
Divaricatori - Pinza per fissare l'osso
Separadores - Pinzas para sujeción para hueso
Écarteurs - Daviers à os

Tibia Wundspreizer
Tibial and Iliac Retractor
Divaricatore per tibia e cresta iliaca
Separadores tibiales e iliacos
Écarteur pour tibia e crête iliaque

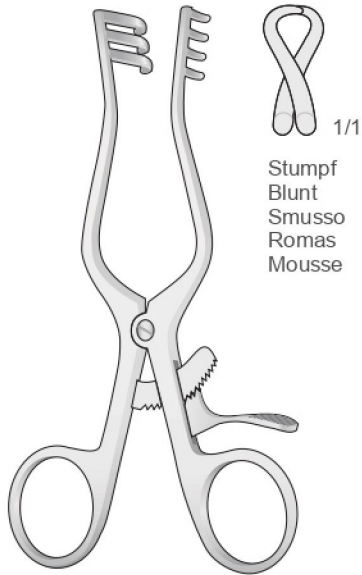

WEITLANER
DI-BV-23
165 mm

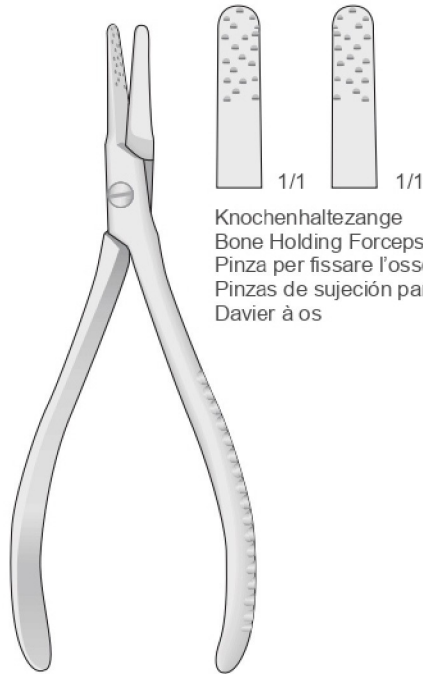

RADOLF
DI-FO-159
135 mm

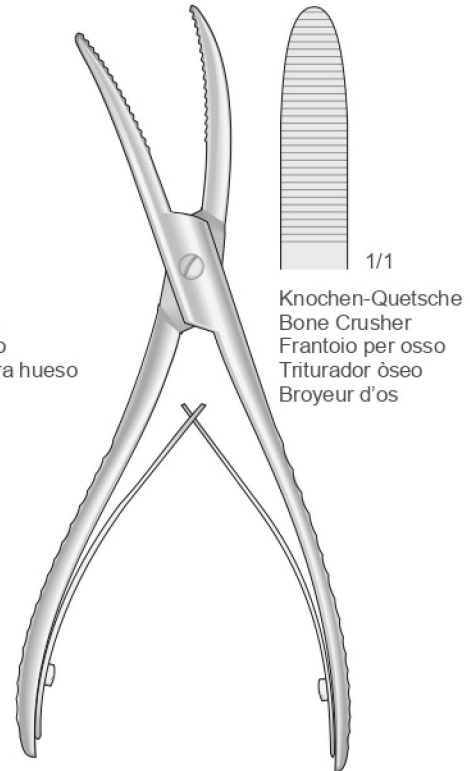

WOLFF
DHLX-113
180 mm

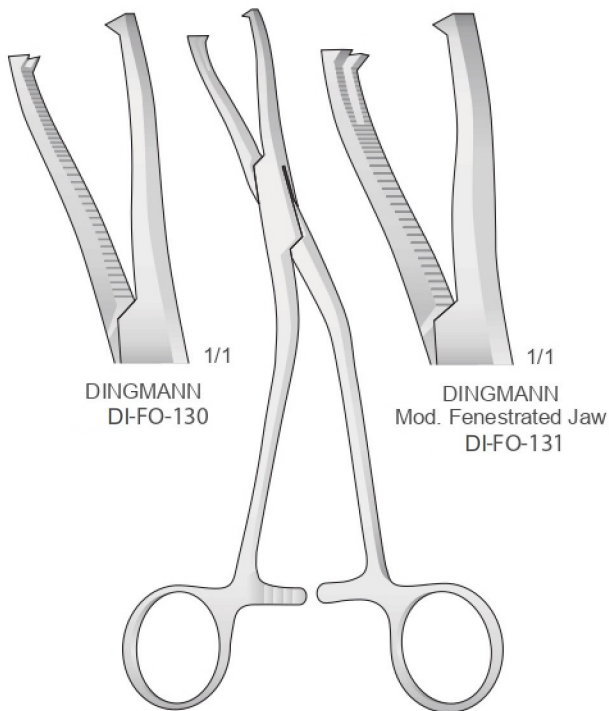

DINGMANN
DI-FO-130/ DI-FO-131
190 mm

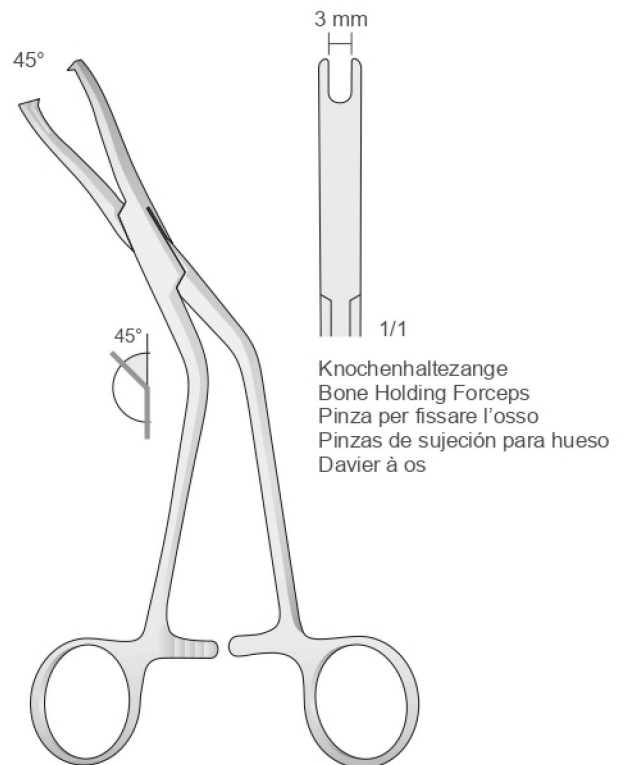

DINGMANN - Mod. Fenestrated Jaw
DI-FO-131S
190 mm